



The following document contains information on Cypress products. Although the document is marked with the name "Spansion" and "Fujitsu", the company that originally developed the specification, Cypress will continue to offer these products to new and existing customers.

Continuity of Specifications

There is no change to this document as a result of offering the device as a Cypress product. Any changes that have been made are the result of normal document improvements and are noted in the document history page, where supported. Future revisions will occur when appropriate, and changes will be noted in a document history page.

Continuity of Ordering Part Numbers

Cypress continues to support existing part numbers. To order these products, please use only the Ordering Part Numbers listed in this document.

For More Information

Please contact your local sales office for additional information about Cypress products and solutions.

About Cypress

Cypress (NASDAQ: CY) delivers high-performance, high-quality solutions at the heart of today's most advanced embedded systems, from automotive, industrial and networking platforms to highly interactive consumer and mobile devices. With a broad, differentiated product portfolio that includes NOR flash memories, F-RAM™ and SRAM, Traveo™ microcontrollers, the industry's only PSoC® programmable system-on-chip solutions, analog and PMIC Power Management ICs, CapSense® capacitive touch-sensing controllers, and Wireless BLE Bluetooth® Low-Energy and USB connectivity solutions, Cypress is committed to providing its customers worldwide with consistent innovation, best-in-class support and exceptional system value.

16-bit Microcontroller

CMOS

F²MC-16LX MB90920 Series

**MB90F922NC/F922NCS/922NCS/F923NC/F923NCS/
MB90F924NC/F924NCS/V920-101/V920-102**

■ DESCRIPTION

The MB90920 series is a family of general-purpose FUJITSU SEMICONDUCTOR 16-bit microcontrollers designed for applications such as vehicle instrument panel control.

The instruction set retains the AT architecture from the F²MC-8L and F²MC-16LX families, with further refinements including high-level language instructions, extended addressing modes, improved multiplication and division operations (signed), and bit processing. In addition, long word processing is made possible by the inclusion of a built-in 32-bit accumulator.

Note : F²MC is the abbreviation of FUJITSU Flexible Microcontroller.

■ FEATURES

- Clock
Built-in PLL clock frequency multiplication circuit.
Selection of machine clocks (PLL clocks) is allowed among frequency division by two on oscillation clock, and multiplication of 1 to 8 times of oscillation clock (for 4 MHz oscillation clock, 4 MHz to 32 MHz).
Operation by sub clock (up to 50 kHz : 100 kHz oscillation clock divided by two) is allowed.
- 16-bit input capture (8 channels)
Detects rising, falling, or both edges.
16-bit capture register × 8
The value of a 16-bit free-run timer counter is latched upon detection of an edge input to pin and an interrupt request is generated.

(Continued)

For the information for microcontroller supports, see the following web site.

This web site includes the "**Customer Design Review Supplement**" which provides the latest cautions on system development and the minimal requirements to be checked to prevent problems before the system development.

<http://edevice.fujitsu.com/micom/en-support/>

MB90920 Series

(Continued)

- 16-bit reload timer (4 channels)
16-bit reload timer operation (select toggle output or one-shot output)
Selectable event count function
- Real time watch timer (main clock)
Operates directly from oscillator clock.
Interrupt can be generated by second/minute/hour/date counter overflow.
- PPG timer (6 channels)
Output pins (3 channels), external trigger input pin (1 channel)
Operation clock frequencies : f_{CP} , $f_{CP}/2^2$, $f_{CP}/2^4$, $f_{CP}/2^6$
- Delay interrupt
Generates interrupt for task switching.
Interrupts to CPU can be generated/cleared by software setting.
- External interrupts (8 channels)
8-channel independent operation
Interrupt source setting available : “L” to “H” edge/ “H” to “L” edge/ “L” level/ “H” level.
- 8/10-bit A/D converter (8 channels)
Conversion time : 3 μ s (at $f_{CP} = 32$ MHz)
External trigger activation available (P50/INT0/ADTG)
Internal timer activation available (16-bit reload timer 1)
- UART(LIN/SCI) (4 channels)
Equipped with full duplex double buffer
Clock-asynchronous or clock-synchronous serial transfer is available
- CAN interface (4 channels : CAN0 and CAN2, and CAN1 and CAN3 share transmission and reception pins, and interrupt control registers).
Conforms to CAN specifications version 2.0 Part A and B.
Automatic resend in case of error.
Automatic transfer in response to remote frame.
16 prioritized message buffers for data and ID
Multiple message support
Flexible configuration for receive filter : Full bit compare/full bit mask/two partial bit masks
Supports up to 1 Mbps
CAN wakeup function (RX connected to INT0 internally)
- LCD controller/driver (32 segment x 4 common)
Segment driver and command driver with direct LCD panel (display) drive capability
- Reset on detection of low voltage/program loop
Automatic reset when low voltage is detected
Program looping detection function
- Stepping motor controller (4 channels)
High current output for each channel $\times 4$
Synchronized 8/10-bit PWM for each channel $\times 2$
- Sound generator (2 channels)
8-bit PWM signal mixed with tone frequency from 8-bit reload counter.
PWM frequencies : 125 kHz, 62.5 kHz, 31.2 kHz, 15.6 kHz (at $f_{CP} = 32$ MHz)
Tone frequencies : PWM frequency /2/ , divided by (reload frequency +1)
- Input/output ports
General-purpose input/output port (CMOS output) 93 ports
- Function for port input level selection
Automotive/CMOS-Schmitt
- Flash memory security function
Protects the contents of Flash memory (Flash memory product only)

MB90920 Series

■ PRODUCT LINEUP

Part number Parameter	MB90 F922NC	MB90 F922NCS	MB90 F923NC	MB90 F923NCS	MB90 F924NC	MB90 F924NCS	MB90 922NCS	MB90 V920-101	MB90 V920-102
Type	Flash memory product						MASK ROM product	Evaluation product	
CPU	F ² MC-16LX CPU								
System clock	PLL clock multiplier circuit (× 1, × 2, × 3, × 4, × 8, 1/2 when PLL stopped) Minimum instruction execution time 31.25 ns (with 4 MHz oscillation clock × 8)								
Sub clock pins (X0A, X1A)	Yes	No	Yes	No	Yes	No	No	No	Yes
ROM	Flash memory 256 Kbytes		Flash memory 384 Kbytes		Flash memory 512 Kbytes		256 K bytes	External	
RAM	10 Kbytes		16 Kbytes		24 Kbytes		10 K bytes	30 Kbytes	
I/O port	91 ports	93 ports	91 ports	93 ports	91 ports	93 ports	93 ports	93 ports	91 ports
LCD controller	32 segment × 4 common								
LIN-UART	UART (LIN/SCI) 4 channels								
CAN interface	4 channels								
16-bit input capture	8 channels								
16-bit reload timer	4 channels								
16-bit free-run timer	1 channel								
Real time watch timer	1 channel								
16-bit PPG timer	6 channels								
External interrupt	8 channels								
8/10-bit A/D converter	8 channels								
Low-voltage/ CPU operating detection reset	Yes						No		
Stepping motor controller	4 channels								
Sound generator	2 channels								
Flash memory security	Yes						—		
Operating voltage	4.0 V to 5.5 V						4.5 V to 5.5 V		
Package	LQFP-120						PGA-299		

MB90920 Series

■ PIN ASSIGNMENT



■ PIN DESCRIPTIONS

Pin no.	Pin name	I/O circuit type*1	Function
108	X0	A	High-speed oscillation input pin
107	X1		High-speed oscillation output pin
13	X0A	B	Low-speed oscillation input pin
	P92	I	General-purpose I/O port
14	X1A	B	Low-speed oscillation output pin
	P93	I	General-purpose I/O port
90	$\overline{\text{RST}}$	C	Reset input pin
93	P00	F	General-purpose I/O port
	SEG24		LCD controller/driver segment output pin
94	P01	F	General-purpose I/O port
	SEG25		LCD controller/driver segment output pin
95	P02	F	General-purpose I/O port
	SEG26		LCD controller/driver segment output pin
96	P03	F	General-purpose I/O port
	SEG27		LCD controller/driver segment output pin
97	P04	F	General-purpose I/O port
	SEG28		LCD controller/driver segment output pin
98	P05	F	General-purpose I/O port
	SEG29		LCD controller/driver segment output pin
99	P06	F	General-purpose I/O port
	SEG30		LCD controller/driver segment output pin
100	P07	F	General-purpose I/O port
	SEG31		LCD controller/driver segment output pin
101	P10	I	General-purpose I/O port
	PPG2		16-bit PPG ch.2 output pin
	IN5		Input capture ch.5 trigger input pin
102	P11	I	General-purpose I/O port
	TOT0		16-bit reload timer ch.0 TOT output pin
	PPG3		16-bit PPG ch.3 output pin
	IN4		Input capture ch.4 trigger input pin
103	P12	I	General-purpose I/O port
	TIN0		16-bit reload timer ch.0 TIN input pin
	PPG4		16-bit PPG ch.4 output pin

(Continued)

MB90920 Series

Pin no.	Pin name	I/O circuit type*1	Function
104	P13	I	General-purpose I/O port
	PPG5		16-bit PPG ch.5 output pin
109	P14	I	General-purpose I/O port
	TIN2		16-bit reload timer ch.2 TIN input pin
	IN1		Input capture ch.1 trigger input pin
110	P15	I	General-purpose I/O port
	IN0		Input capture ch.0 trigger input pin
111	COM0	P	LCD controller/driver common output pin
112	COM1	P	LCD controller/driver common output pin
113	COM2	P	LCD controller/driver common output pin
114	COM3	P	LCD controller/driver common output pin
115	P22	F	General-purpose I/O port
	SEG00		LCD controller/driver segment output pin
116	P23	F	General-purpose I/O port
	SEG01		LCD controller/driver segment output pin
117	P24	F	General-purpose I/O port
	SEG02		LCD controller/driver segment output pin
118	P25	F	General-purpose I/O port
	SEG03		LCD controller/driver segment output pin
119	P26	F	General-purpose I/O port
	SEG04		LCD controller/driver segment output pin
120	P27	F	General-purpose I/O port
	SEG05		LCD controller/driver segment output pin
1	P30	F	General-purpose I/O port
	SEG06		LCD controller/driver segment output pin
2	P31	F	General-purpose I/O port
	SEG07		LCD controller/driver segment output pin
3	P32	F	General-purpose I/O port
	SEG08		LCD controller/driver segment output pin
4	P33	F	General-purpose I/O port
	SEG09		LCD controller/driver segment output pin
5	P34	F	General-purpose I/O port
	SEG10		LCD controller/driver segment output pin
6	P35	F	General-purpose I/O port
	SEG11		LCD controller/driver segment output pin

(Continued)

MB90920 Series

Pin no.	Pin name	I/O circuit type*1	Function
7	P36	F	General-purpose I/O port
	SEG12		LCD controller/driver segment output pin
8	P37	F	General-purpose I/O port
	SEG13		LCD controller/driver segment output pin
9	P40	F	General-purpose I/O port
	SEG14		LCD controller/driver segment output pin
10	P41	F	General-purpose I/O port
	SEG15		LCD controller/driver segment output pin
11	P42	F	General-purpose I/O port
	SEG16		LCD controller/driver segment output pin
12	P43	F	General-purpose I/O port
	SEG17		LCD controller/driver segment output pin
18	P44	F	General-purpose I/O port
	SEG18		LCD controller/driver segment output pin
19	P45	F	General-purpose I/O port
	SEG19		LCD controller/driver segment output pin
20	P46	F	General-purpose I/O port
	SEG20		LCD controller/driver segment output pin
21	P47	F	General-purpose I/O port
	SEG21		LCD controller/driver segment output pin
37	P50	I	General-purpose I/O port
	INT0		INT0 external interrupt input pin
	ADTG		A/D converter external trigger input pin
58	P51	I	General-purpose I/O port
	INT1		INT1 external interrupt input pin
	RX1		CAN interface 1 RX input pin
	RX3		CAN interface 3 RX input pin
59	P52	I	General-purpose I/O port
	TX1		CAN interface 1 TX output pin
	TX3		CAN interface 3 TX output pin
60	P53	I	General-purpose I/O port
	INT3		INT3 external interrupt input pin

(Continued)

MB90920 Series

Pin no.	Pin name	I/O circuit type*1	Function
61	P54	I	General-purpose I/O port
	TX0		CAN interface 0 TX output pin
	TX2		CAN interface 2 TX output pin
	SGA1		Sound generator ch.1 SGA output pin
63	P55	I	General-purpose I/O port
	RX0		CAN interface 0 RX input pin
	RX2		CAN interface 2 RX input pin
	INT2		INT2 external interrupt input pin
91	P56	I	General-purpose I/O port
	SGO0		Sound generator ch.0 SGO output pin
	FRCK		Free-run timer clock input pin
92	P57	I	General-purpose I/O port
	SGA0		Sound generator ch.0 SGA output pin
39	P60	H	General-purpose I/O port
	AN0		A/D converter input pin
40	P61	H	General-purpose I/O port
	AN1		A/D converter input pin
41	P62	H	General-purpose I/O port
	AN2		A/D converter input pin
42	P63	H	General-purpose I/O port
	AN3		A/D converter input pin
43	P64	H	General-purpose I/O port
	AN4		A/D converter input pin
44	P65	H	General-purpose I/O port
	AN5		A/D converter input pin
45	P66	H	General-purpose I/O port
	AN6		A/D converter input pin
46	P67	H	General-purpose I/O port
	AN7		A/D converter input pin
67	P70	L	General-purpose output-only port
	PWM1P0		Stepping motor controller ch.0 output pin
68	P71	L	General-purpose output-only port
	PWM1M0		Stepping motor controller ch.0 output pin
69	P72	L	General-purpose output-only port
	PWM2P0		Stepping motor controller ch.0 output pin

(Continued)

MB90920 Series

Pin no.	Pin name	I/O circuit type*1	Function
70	P73	L	General-purpose output-only port
	PWM2M0		Stepping motor controller ch.0 output pin
71	P74	L	General-purpose output-only port
	PWM1P1		Stepping motor controller ch.1 output pin
72	P75	L	General-purpose output-only port
	PWM1M1		Stepping motor controller ch.1 output pin
73	P76	L	General-purpose output-only port
	PWM2P1		Stepping motor controller ch.1 output pin
74	P77	L	General-purpose output-only port
	PWM2M1		Stepping motor controller ch.1 output pin
77	P80	L	General-purpose output-only port
	PWM1P2		Stepping motor controller ch.2 output pin
78	P81	L	General-purpose output-only port
	PWM1M2		Stepping motor controller ch.2 output pin
79	P82	L	General-purpose output-only port
	PWM2P2		Stepping motor controller ch.2 output pin
80	P83	L	General-purpose output-only port
	PWM2M2		Stepping motor controller ch.2 output pin
81	P84	L	General-purpose output-only port
	PWM1P3		Stepping motor controller ch.3 output pin
82	P85	L	General-purpose output-only port
	PWM1M3		Stepping motor controller ch.3 output pin
83	P86	L	General-purpose output-only port
	PWM2P3		Stepping motor controller ch.3 output pin
84	P87	L	General-purpose output-only port
	PWM2M3		Stepping motor controller ch.3 output pin
22	P90	F	General-purpose I/O port
	SEG22		LCD controller/driver segment output pin
23	P91	F	General-purpose I/O port
	SEG23		LCD controller/driver segment output pin
31	P94	G	General-purpose I/O port
	V0		LCD controller/driver reference power supply pin
32	P95	G	General-purpose I/O port
	V1		LCD controller/driver reference power supply pin

(Continued)

MB90920 Series

Pin no.	Pin name	I/O circuit type*1	Function
33	P96	G	General-purpose I/O port
	V2		LCD controller/driver reference power supply pin
34	V3	—	LCD controller/driver reference power supply pin
48	PC0	J	General-purpose I/O port
	SIN0		UART ch.0 serial data input pin
	INT4		INT4 external interrupt input pin
49	PC1	I	General-purpose I/O port
	SOT0		UART ch.0 serial data output pin
	INT5		INT5 external interrupt input pin
	IN3		Input capture ch.3 trigger input pin
50	PC2	I	General-purpose I/O port
	SCK0		UART ch.0 serial clock I/O pin
	INT6		INT6 external interrupt input pin
	IN2		Input capture ch.2 trigger input pin
51	PC3	J	General-purpose I/O port
	SIN1		UART ch.1 serial data input pin
	INT7		INT7 external interrupt input pin
52	PC4	I	General-purpose I/O port
	SOT1		UART ch.1 serial data output pin
53	PC5	I	General-purpose I/O port
	SCK1		UART ch.1 serial clock I/O pin
	TRG		16-bit PPG ch.0 to ch.5 external trigger input pin
54	PC6	I	General-purpose I/O port
	PPG0		16-bit PPG ch.0 output pin
	TOT1		16-bit reload timer ch.1 TOT output pin
	IN7		Input capture ch.7 trigger input pin
55	PC7	I	General-purpose I/O port
	PPG1		16-bit PPG ch.1 output pin
	TIN1		16-bit reload timer ch.1 TIN input pin
	IN6		Input capture ch.6 trigger input pin
24	PD0	J	General-purpose I/O port
	SIN2		UART ch.2 serial data input pin
25	PD1	I	General-purpose I/O port
	SOT2		UART ch.2 serial data output pin

(Continued)

(Continued)

Pin no.	Pin name	I/O circuit type*1	Function
26	PD2	I	General-purpose I/O port
	SCK2		UART ch.2 serial clock I/O pin
27	PD3	J	General-purpose I/O port
	SIN3		UART ch.3 serial data input pin
28	PD4	I	General-purpose I/O port
	SOT3		UART ch.3 serial data output pin
29	PD5	I	General-purpose I/O port
	SCK3		UART ch.3 serial clock I/O pin
30	PD6	I	General-purpose I/O port
	TOT2		16-bit reload timer ch.2 TOT output pin
56	PE0	I	General-purpose I/O port
	TOT3		16-bit reload timer ch.3 TOT output pin
57	PE1	I	General-purpose I/O port
	TIN3		16-bit reload timer ch.3 TIN input pin
64	PE2	I	General-purpose I/O port
	SGO1		Sound generator ch.1 SGO output pin
62	RSTO	N	Internal reset signal output pin
65, 75, 85	DVCC	—	Power supply input pins dedicated for high current output buffer
66, 76, 86	DVSS	—	Power supply GND pins dedicated for high current output buffer
35	AVCC	—	A/D converter dedicated power supply input pin
38	AVSS	—	A/D converter dedicated power supply GND pin
36	AVRH	—	A/D converter Vref+ input pin. Vref- is fixed to AVSS.
89	MD0	D	Mode setting input pin. Connect to VCC pin.
88	MD1	D	Mode setting input pin. Connect to VCC pin.
87	MD2	D/E*2	Mode setting input pin. Connect to VSS pin.
17	C	—	External capacitor pin. Connect a 0.1 μF capacitor between this pin and the VSS pin.
15, 105	VCC	—	Power supply input pins
16, 47, 106	VSS	—	GND power supply pins

*1 : For I/O circuit type, refer to “■ I/O CIRCUIT TYPES”.

*2 : The I/O circuit type is D for Flash memory products and E for evaluation products.

MB90920 Series

■ I/O CIRCUIT TYPE

Type	Circuit	Remarks
A		Oscillation circuit High-speed oscillation feedback resistance : approx. 1 M Ω (Flash memory product/MASK ROM product/Evaluation product)
B		Oscillation circuit Low-speed oscillation feedback resistance : approx. 10 M Ω
C		Input-only pin (with pull-up resistance) <ul style="list-style-type: none"> • Attached pull-up resistor : approx. 50 kΩ • CMOS hysteresis input ($V_{IH}/V_{IL} = 0.8 V_{CC}/0.2 V_{CC}$)
D		Input-only pin <ul style="list-style-type: none"> • CMOS hysteresis input ($V_{IH}/V_{IL} = 0.8 V_{CC}/0.2 V_{CC}$) Note: The MD2 pin of the Flash memory products uses this circuit type.

(Continued)

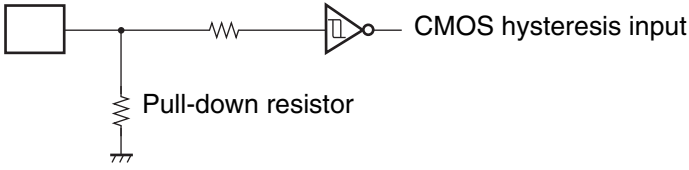
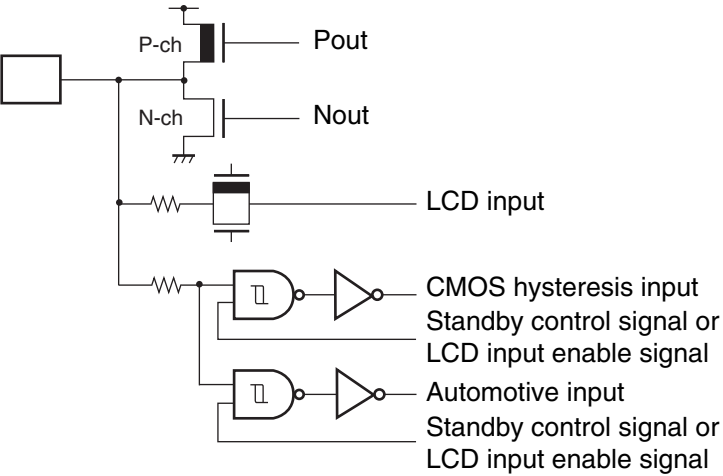
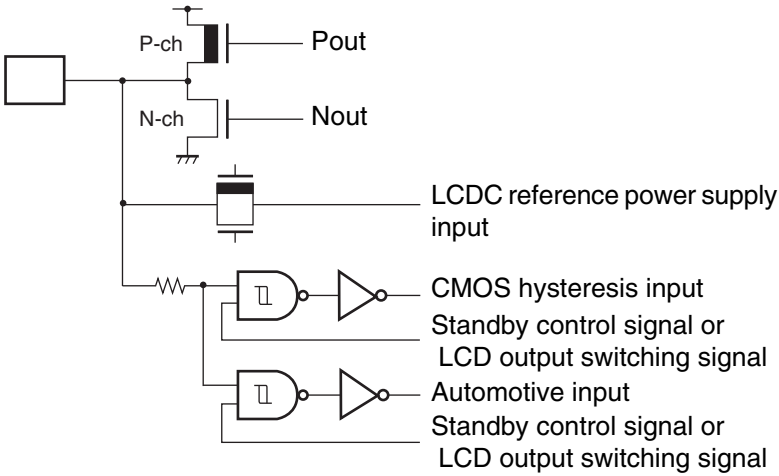
Type	Circuit	Remarks
E	 <p>Pull-down resistor</p> <p>CMOS hysteresis input</p>	<p>Input-only pin (with pull-down resistance)</p> <ul style="list-style-type: none"> Attached pull-down resistance: approx. 50 kΩ CMOS hysteresis input ($V_{IH}/V_{IL} = 0.8 V_{CC}/0.2 V_{CC}$) <p>Note: The MD2 pin of the evaluation products uses this circuit type.</p>
F	 <p>P-ch Pout</p> <p>N-ch Nout</p> <p>LCD input</p> <p>CMOS hysteresis input Standby control signal or LCD input enable signal</p> <p>Automotive input Standby control signal or LCD input enable signal</p>	<p>LCD output common general-purpose port</p> <ul style="list-style-type: none"> CMOS output ($I_{OH}/I_{OL} = \pm 4 \text{ mA}$) Hysteresis input ($V_{IH}/V_{IL} = 0.8 V_{CC}/0.2 V_{CC}$) Automotive input ($V_{IH}/V_{IL} = 0.8 V_{CC}/0.5 V_{CC}$)
G	 <p>P-ch Pout</p> <p>N-ch Nout</p> <p>LDC reference power supply input</p> <p>CMOS hysteresis input Standby control signal or LCD output switching signal</p> <p>Automotive input Standby control signal or LCD output switching signal</p>	<p>LDC reference power supply common general-purpose port</p> <ul style="list-style-type: none"> CMOS output ($I_{OH}/I_{OL} = \pm 4 \text{ mA}$) CMOS hysteresis input ($V_{IH}/V_{IL} = 0.8 V_{CC}/0.2 V_{CC}$) Automotive input ($V_{IH}/V_{IL} = 0.8 V_{CC}/0.5 V_{CC}$)

(Continued)

MB90920 Series

Type	Circuit	Remarks
H	<p> P-ch N-ch Pout Nout Analog input CMOS hysteresis input Standby control signal or analog input enable signal Automotive input Standby control signal or analog input enable signal </p>	A/D converter input common general-purpose port <ul style="list-style-type: none"> • CMOS output ($I_{OH}/I_{OL} = \pm 4 \text{ mA}$) • CMOS hysteresis input ($V_{IH}/V_{IL} = 0.8 V_{CC}/0.2 V_{CC}$) • Automotive input ($V_{IH}/V_{IL} = 0.8 V_{CC}/0.5 V_{CC}$)
I	<p> P-ch N-ch Pout Nout CMOS hysteresis input Standby control signal Automotive input Standby control signal </p>	General-purpose port <ul style="list-style-type: none"> • CMOS output ($I_{OH}/I_{OL} = \pm 4 \text{ mA}$) • CMOS hysteresis input ($V_{IH}/V_{IL} = 0.8 V_{CC}/0.2 V_{CC}$) • Automotive input ($V_{IH}/V_{IL} = 0.8 V_{CC}/0.5 V_{CC}$)
J	<p> P-ch N-ch Pout Nout CMOS hysteresis input Standby control signal Automotive input Standby control signal CMOS input (SIN) Standby control signal </p>	General-purpose port (serial input) <ul style="list-style-type: none"> • CMOS output ($I_{OH}/I_{OL} = \pm 4 \text{ mA}$) • CMOS hysteresis input ($V_{IH}/V_{IL} = 0.8 V_{CC}/0.2 V_{CC}$) • CMOS input (SIN) ($V_{IH}/V_{IL} = 0.7 V_{CC}/0.3 V_{CC}$) • Automotive input ($V_{IH}/V_{IL} = 0.8 V_{CC}/0.5 V_{CC}$)

(Continued)

Type	Circuit	Remarks
K	<p>P-ch — Pout N-ch — Nout Analog output CMOS hysteresis input Standby control signal or analog input enable signal Automotive input Standby control signal or analog input enable signal CMOS input (SIN) Standby control signal or analog input enable signal</p>	<p>A/D converter input common general-purpose port (serial input)</p> <ul style="list-style-type: none"> • CMOS output ($I_{OH}/I_{OL} = \pm 4 \text{ mA}$) • CMOS hysteresis input ($V_{IH}/V_{IL} = 0.8 V_{CC}/0.2 V_{CC}$) • CMOS input (SIN) ($V_{IH}/V_{IL} = 0.7 V_{CC}/0.3 V_{CC}$) • Automotive input ($V_{IH}/V_{IL} = 0.8 V_{CC}/0.5 V_{CC}$)
L	<p>P-ch — Pout High current N-ch — Nout</p>	<p>High current output port (SMC pin) CMOS output ($I_{OH}/I_{OL} = \pm 30 \text{ mA}$)</p>
M	<p>P-ch — Pout N-ch — Nout LCDC output CMOS hysteresis input Standby control signal or LCDC output switching signal Automotive input Standby control signal or LCDC output switching signal CMOS input (SIN) Standby control signal or LCDC output switching signal</p>	<p>LCDC output common general-purpose port (serial input)</p> <ul style="list-style-type: none"> • CMOS output ($I_{OH}/I_{OL} = \pm 4 \text{ mA}$) • CMOS hysteresis input ($V_{IH}/V_{IL} = 0.8 V_{CC}/0.2 V_{CC}$) • CMOS input (SIN) ($V_{IH}/V_{IL} = 0.7 V_{CC}/0.3 V_{CC}$) • Automotive input ($V_{IH}/V_{IL} = 0.8 V_{CC}/0.5 V_{CC}$)

(Continued)

MB90920 Series

(Continued)

Type	Circuit	Remarks
N	<div style="display: flex; justify-content: space-around;"> <div style="text-align: center;"> <p>Evaluation product</p>  </div> <div style="text-align: center;"> <p>Flash memory product</p>  </div> </div>	<p>N-ch open-drain pin $I_{OL} = 4 \text{ mA}$</p>
O		<p>Input-only pin Automotive input $(V_{IH}/V_{IL} = 0.8 V_{CC}/0.5 V_{CC})$</p>
P		<p>LCDC output pin (COM pin)</p>

■ HANDLING DEVICES

- **Strictly observe maximum rated voltages (preventing latch-up)**

In CMOS IC devices, a condition known as latch-up may occur if voltages higher than V_{CC} or lower than V_{SS} are applied to input or output pins other than medium or high withstand voltage pins, or if the voltage applied between V_{CC} and V_{SS} pins exceeds the rated voltage level. If a latch-up occurs, the power supply current may increase dramatically and may destroy semiconductor elements. When using semiconductor devices, always take sufficient care to avoid exceeding maximum ratings.

When the analog system power supply is switched on or off, be careful not to apply the analog power supply (AV_{CC} , AV_{RH}), the analog input voltages and the power supply voltage for the high current output buffer pins (DV_{CC}) in excess of the digital power supply voltage (V_{CC}).

Once the digital power supply voltage (V_{CC}) has been disconnected, the analog power supply (AV_{CC} , AV_{RH}) and the power supply voltage for the high current output buffer pins (DV_{CC}) may be turned on in any sequence.

- **Supply voltage stabilization**

Rapid fluctuations in the power supply voltage can cause malfunctions even if the V_{CC} power supply voltage remains within the warranted operating range. It is recommended that the power supply be stabilized such that ripple fluctuations (P-P value) at commercial frequencies (50 Hz/60 Hz) be limited to within 10% of the standard V_{CC} value, and that transient fluctuations due to power supply switching, etc. be limited to a rate of 0.1 V/ms or less.

- **Precautions when turning the power on**

In order to prevent the built-in step-down circuits from malfunctioning, the time taken for the voltage to rise (0.2 V to 2.7 V) during power-on should be less than 50 μ s.

- **Handling unused pins**

If unused input pins are left open, they may cause malfunctions or latch-up which may lead to permanent damage to the semiconductor. Unused input pins should therefore be pulled up or pulled down through a resistor of at least 2 k Ω .

Unused input/output pins may be set to the output state and left open, or set to the input state and connected to a pull-up or pull-down resistance of 2 k Ω or more.

- **Handling A/D converter power supply pins**

Even if the A/D converter is not used, the power supply pins should be connected such as $AV_{CC} = V_{CC}$, and $AV_{SS} = AVR_{H} = V_{SS}$.

- **Notes on using an external clock**

Even when an external clock is used, an oscillation stabilization wait time is required following power-on reset or release from sub clock mode or stop mode. Furthermore, only the X0A pin should be driven when an external clock is used, with the X1A pin open as shown in the following diagram. Do not use high-speed oscillation pins (X0 and X1) for external clock input.

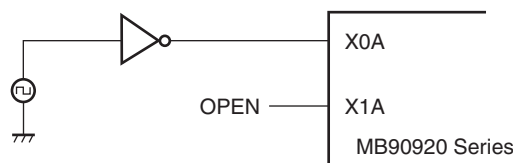

Sample external clock connection

• Notes on operating in PLL clock mode

On this microcontroller, if in case the crystal oscillator breaks off or an external reference clock input stops while the PLL clock mode is selected, a self-oscillator circuit contained in the PLL may continue its operation at its self-running frequency. However, FUJITSU SEMICONDUCTOR will not guarantee results of operations if such failure occurs.

• Crystal oscillator circuit

Noise around the X0/X1, or X0A/X1A pins may cause this device to operate abnormally. In the interest of stable operation it is strongly recommended that printed circuit artwork places ground bypass capacitors as close as possible to the X0/X1, X0A/X1A and crystal oscillator (or ceramic oscillator) and that oscillator lines do not cross the lines of other circuits.

Please ask each crystal maker to evaluate the oscillational characteristics of the crystal and this device.

• Power supply pins

Devices including multiple VCC or VSS pins are designed such that pins that need to be at the same potential are interconnected internally to prevent malfunctions such as latch-up. To reduce unnecessary radiation, prevent malfunctioning of the strobe signal due to the rise of ground level, and observe the standard for total output current, be sure to connect the VCC and VSS pins to the power supply and ground externally.

Always connect all of the VCC pins to the same potential and all of the VSS pins to ground as shown in the following diagram. The device will not operate correctly if multiple VCC or VSS pins are connected to different voltages, even if those voltages are within the guaranteed operating ranges.



In addition, care must be given to connecting the VCC and VSS pins of this device to the current supply source with as low impedance as possible. It is recommended that a 1.0 μF bypass capacitor be connected between the VCC and VSS pins as close to the pins as possible.

• Sequence for connecting the A/D converter power supply and analog inputs

The A/D converter power supply (AV_{CC} , $AVRH$) and analog inputs ($AN0$ to $AN7$) must be applied after the digital power supply (V_{CC}) is switched on. When turning the power off, the A/D converter power supply and analog inputs must be disconnected before the digital power supply is switched off (V_{CC}). Ensure that $AVRH$ does not exceed AV_{CC} during either power-on or power-off. Even when pins which double as analog input pins are used as input ports, be sure that the input voltage does not exceed AV_{CC} (turning on/off the analog and digital power supplies simultaneously is acceptable).

- **Handling the power supply for high-current output buffer pins (DV_{CC} , DV_{SS})**

- **Flash memory products and MASK ROM products (MB90F922NC/F922NCS/922NCS/F923NC/F923NCS/F924NC/F924NCS)**

In the Flash memory products and MASK ROM products, the power supply for the high-current output buffer pins (DV_{CC} , DV_{SS}) is isolated from the digital power supply (V_{CC}).

Therefore, DV_{CC} can therefore be set to a higher voltage than V_{CC} . If the power supply for the high-current output buffer pins (DV_{CC} , DV_{SS}) is supplied before the digital power supply (V_{CC}), however, care needs to be taken because it is possible that the port 7 or port 8 stepping motor outputs may momentarily output an “H” or “L” level. In order to prevent this, connect the digital power supply (V_{CC}) prior to connecting the power supply for the high-current output buffer pins. Even when the high-current output buffer pins are used as general-purpose ports, power should be supplied to the power supply pins for the high-current output buffer pins (DV_{CC} , DV_{SS}).

- **Evaluation product (MB90V920-101/MB90V920-102)**

In the evaluation products, the power supply for the high-current output buffer pins (DV_{CC} , DV_{SS}) is not isolated from the digital power supply (V_{CC}). Therefore, DV_{CC} must therefore be set to a lower voltage than V_{CC} . The power supply for the high-current output buffer pins (DV_{CC} , DV_{SS}) must always be applied after the digital power supply (V_{CC}) has been connected, and disconnected before the digital power supply (V_{CC}) is disconnected (the power supply for the high-current output buffer pins may also be connected and disconnected simultaneously with the digital power supply).

Even when the high-current output buffer pins are used as general-purpose ports, power should be supplied to the power supply pins for the high-current output buffer pins (DV_{CC} , DV_{SS}).

- **Pull-up/pull-down resistors**

MB90920 series does not support internal pull-up/pull-down resistors. Use external components as necessary.

- **Precautions when not using a sub clock signal**

If the X0A and X1A pins are not connected to an oscillator, apply a pull-down resistance to the X0A pin and leave the X1A pin open.

- **Notes on operating when the external clock is stopped**

The MB90920 series is not guaranteed to operate correctly using the internal oscillator circuit when there is no external oscillator or the external clock input is stopped.

- **Flash memory security function**

A security bit is located within the Flash memory region. The security function is activated by writing the protection code 01_H to the security bit.

Do not write the value 01_H to this address if you are not using the security function.

Please refer to following table for the address of the security bit.

	Flash memory size	Address for security bit
MB90F922NC MB90F922NCS	Built-in 2 Mbits Flash Memory	FC0001 _H
MB90F923NCS	Built-in 3 Mbits Flash Memory	F80001 _H
MB90F924NCS	Built-in 4 Mbits Flash Memory	F80001 _H

- **Serial communication**

In serial communication, reception of wrong data may occur due to noise or other causes. Therefore, design a printed circuit board to prevent noise from occurring. Taking account of the reception of wrong data, detect errors by measures such as adding a checksum to the end of data. If an error is detected, retransmit the data.

- **Characteristic difference between flash device and MASK ROM device**

In the flash device and the MASK ROM device, the electrical characteristic including current consumption, ESD, latch-up, the noise characteristic, and oscillation characteristic, etc. is different according to the difference between the chip layout and the memory structure.

Reconfirm the electrical characteristic when the product is replaced by another product of the same series.

■ BLOCK DIAGRAM



MB90920 Series

MEMORY MAP

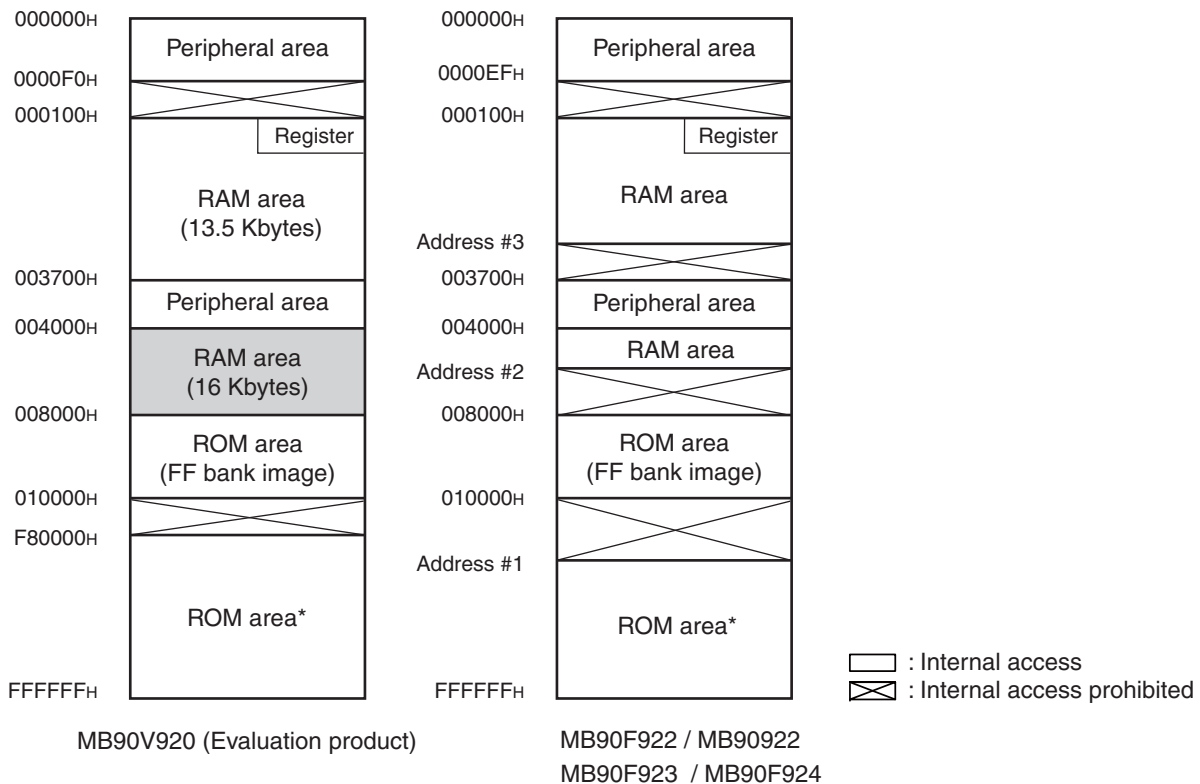

Parts No.	ROM (Flash) capacitance	RAM capacitance	Address #1	Address #2	Address #3
MB90F922NC/F922NCS/922NCS	256 Kbytes	10 Kbytes	FC000H	004A00H	002900H
MB90F923NC/F923NCS	384 Kbytes	16 Kbytes	FA0000H	004A00H	003700H
MB90F924NC/F924NCS	512 Kbytes	24 Kbytes	F80000H	006A00H	003700H

* : Evaluation products do not contain internal ROM. Treat this address as the ROM decode area used by the tools.

Note: To select models without the ROM mirror function, refer to the “ROM Mirror Function Selection Module” in Hardware Manual. The image of the ROM data in the FF bank appears at the top of the 00 bank, in order to enable efficient use of small C compiler models. The lower 16-bits of the FF bank addresses are allocated to the same addresses as the lower 16-bits of the 00 bank, making it possible to reference tables in ROM without declaring the “far” modifier with the pointers. For example, when an access is made to the address 00C000H, the actual address to be accessed is FFC000H in ROM. Because the size of the FF bank ROM area exceeds 32 Kbytes, it is not possible to view the entire region in the 00 bank image. Therefore because the ROM data from FF8000H to FFFFFFFH appears in the image from 008000H to 00FFFFH, it is recommended that ROM data tables be stored in the area from FF8000H to FFFFFFFH.

■ I/O MAP

Address	Register name	Symbol	Read/write	Resource name	Initial value
00000H	Port 0 data register	PDR0	R/W	Port 0	XXXXXXXX _B
00001H	Port 1 data register	PDR1	R/W	Port 1	XXXXXXXX _B
00002H	Port 2 data register	PDR2	R/W	Port 2	XXXXXXXX _B
00003H	Port 3 data register	PDR3	R/W	Port 3	XXXXXXXX _B
00004H	Port 4 data register	PDR4	R/W	Port 4	XXXXXXXX _B
00005H	Port 5 data register	PDR5	R/W	Port 5	XXXXXXXX _B
00006H	Port 6 data register	PDR6	R/W	Port 6	XXXXXXXX _B
00007H	Port 7 data register	PDR7	R/W	Port 7	XXXXXXXX _B
00008H	Port 8 data register	PDR8	R/W	Port 8	XXXXXXXX _B
00009H	Port 9 data register	PDR9	R/W	Port 9	XXXXXXXX _B
0000AH, 0000BH	(Disabled)				
0000CH	Port C data register	PDRC	R/W	Port C	XXXXXXXX _B
0000DH	Port D data register	PDRD	R/W	Port D	XXXXXXXX _B
0000EH	Port E data register	PDRE	R/W	Port E	XXXXXXXX _B
0000FH	(Disabled)				
00010H	Port 0 direction register	DDR0	R/W	Port 0	00000000 _B
00011H	Port 1 direction register	DDR1	R/W	Port 1	XX000000 _B
00012H	Port 2 direction register	DDR2	R/W	Port 2	000000XX _B
00013H	Port 3 direction register	DDR3	R/W	Port 3	00000000 _B
00014H	Port 4 direction register	DDR4	R/W	Port 4	00000000 _B
00015H	Port 5 direction register	DDR5	R/W	Port 5	00000000 _B
00016H	Port 6 direction register	DDR6	R/W	Port 6	00000000 _B
00017H	Port 7 direction register	DDR7	R/W	Port 7	00000000 _B
00018H	Port 8 direction register	DDR8	R/W	Port 8	00000000 _B
00019H	Port 9 direction register	DDR9	R/W	Port 9	X0000000 _B
0001AH	Analog input enable	ADER6	R/W	Port 6, A/D	11111111 _B
0001BH	(Disabled)				
0001CH	Port C direction register	DDRC	R/W	Port C	00000000 _B
0001DH	Port D direction register	DDRD	R/W	Port D	X0000000 _B
0001EH	Port E direction register	DDRE	R/W	Port E	XXXXX000 _B
0001FH	(Disabled)				
00020H	Lower A/D control status register	ADCS0	R/W	A/D converter	00XXXX00 _B
00021H	Higher A/D control status register	ADCS1	R/W		0000000X _B
00022H	Lower A/D control status register	ADCR0	R		00000000 _B
00023H	Higher A/D data register	ADCR1	R		XXXXXX00 _B

(Continued)

MB90920 Series

Address	Register name	Symbol	Read/write	Resource name	Initial value
000024 _H	Compare clear register	CPCLR	R/W	16-bit free-run timer	XXXXXXXX _B
000025 _H			R/W		XXXXXXXX _B
000026 _H	Timer data register	TCDT	R/W		00000000 _B
000027 _H			R/W		00000000 _B
000028 _H	Lower timer control status register	TCCSL	R/W		00000000 _B
000029 _H	Higher timer control status register	TCCSH	R/W		01-00000 _B
00002A _H	Lower PPG0 control status register	PCNTL0	R/W	16-bit PPG0	00000000 _B
00002B _H	Higher PPG0 control status register	PCNTH0	R/W		00000001 _B
00002C _H	Lower PPG1 control status register	PCNTL1	R/W	16-bit PPG1	00000000 _B
00002D _H	Higher PPG1 control status register	PCNTH1	R/W		00000001 _B
00002E _H	Lower PPG2 control status register	PCNTL2	R/W	16-bit PPG2	00000000 _B
00002F _H	Higher PPG2 control status register	PCNTH2	R/W		00000001 _B
000030 _H	External interrupt enable	ENIR	R/W	External interrupt	00000000 _B
000031 _H	External interrupt request	EIRR	R/W		00000000 _B
000032 _H	Lower external interrupt level	ELVRL	R/W		00000000 _B
000033 _H	Higher external interrupt level	ELVRH	R/W		00000000 _B
000034 _H	Serial mode register 0	SMR0	R/W, W	UART (LIN/SCI) 0	00000000 _B
000035 _H	Serial control register 0	SCR0	R/W, W		00000000 _B
000036 _H	Reception/transmission data register 1	RDR0/ TDR0	R/W		00000000 _B
000037 _H	Serial status register 0	SSR0	R/W, R		00001000 _B
000038 _H	Extended communication control register 0	ECCR0	R/W, R		000000XX _B
000039 _H	Extended status control register 0	ESCR0	R/W		00000100 _B
00003A _H	Baud rate generator register 00	BGR00	R/W		00000000 _B
00003B _H	Baud rate generator register 01	BGR01	R/W, R		00000000 _B
00003C _H to 00003F _H	(Disabled)				
000040 _H to 00004F _H	Area reserved for CAN Controller 0. Refer to "■ CAN CONTROLLERS"				
000050 _H	Lower timer control status register 0	TMCSR0L	R/W	16-bit reload timer 0	00000000 _B
000051 _H	Higher timer control status register 0	TMCSR0H	R/W		XXX10000 _B
000052 _H	Timer register 0/reload register 0	TMR0/ TMRLR0	R/W		XXXXXXXX _B
000053 _H					XXXXXXXX _B

(Continued)

MB90920 Series

Address	Register name	Symbol	Read/write	Resource name	Initial value
000054 _H	Lower timer control status register 1	TMCSR1L	R/W	16-bit reload timer 1	00000000 _B
000055 _H	Higher timer control status register 1	TMCSR1H	R/W		XXX10000 _B
000056 _H	Timer register 1/reload register 1	TMR1/ TMRLR1	R/W		XXXXXXXX _B
000057 _H		XXXXXXXX _B			
000058 _H	LCD output control register 1	LOCR1	R/W	LCDC	11111111 _B
000059 _H	LCD output control register 2	LOCR2	R/W		00000000 _B
00005A _H	Lower sound control register 0	SGCRL0	R/W	Sound generator 0	00000000 _B
00005B _H	Higher sound control register 0	SGCRH0	R/W		0XXXX100 _B
00005C _H	Frequency data register 0	SGFR0	R/W		XXXXXXXX _B
00005D _H	Amplitude data register 0	SGAR0	R/W		00000000 _B
00005E _H	Decrement grade register 0	SGDR0	R/W		XXXXXXXX _B
00005F _H	Tone count register 0	SGTR0	R/W		XXXXXXXX _B
000060 _H	Input capture register 0	IPCP0	R	Input capture 0/1	XXXXXXXX _B
000061 _H					XXXXXXXX _B
000062 _H	Input capture register 1	IPCP1	R		XXXXXXXX _B
000063 _H					XXXXXXXX _B
000064 _H	Input capture register 2	IPCP2	R	Input capture 2/3	XXXXXXXX _B
000065 _H					XXXXXXXX _B
000066 _H	Input capture register 3	IPCP3	R		XXXXXXXX _B
000067 _H					XXXXXXXX _B
000068 _H	Input capture control status 0/1	ICS01	R/W	Input capture 0/1	00000000 _B
000069 _H	Input capture edge register 0/1	ICE01	R/W		XXX0X0XX _B
00006A _H	Input capture control status 2/3	ICS23	R/W	Input capture 2/3	00000000 _B
00006B _H	Input capture edge register 2/3	ICE23	R/W		XXXXXXXX _B
00006C _H	Lower LCD control register	LCRL	R/W	LCD controller/ driver	00010000 _B
00006D _H	Higher LCD control register	LCRH	R/W		00000000 _B
00006E _H	Low voltage/CPU operation detection reset control register	LVRC	R/W	Low voltage/CPU operation detection reset	00111000 _B
00006F _H	ROM mirror	ROMM	W	ROM mirror	XXXXXXXX1 _B
000070 _H to 00007F _H	Area reserved for CAN Controller 1. Refer to "■ CAN CONTROLLERS"				
000080 _H	PWM control register 0	PWC0	R/W	Stepping motor controller 0	000000X0 _B
000081 _H	(Disabled)				
000082 _H	PWM control register 1	PWC1	R/W	Stepping motor controller 1	000000X0 _B

(Continued)

MB90920 Series

Address	Register name	Symbol	Read/write	Resource name	Initial value
000083 _H	(Disabled)				
000084 _H	PWM control register 2	PWC2	R/W	Stepping motor controller 2	000000X0 _B
000085 _H	(Disabled)				
000086 _H	PWM control register 3	PWC3	R/W	Stepping motor controller 3	000000X0 _B
000087 _H	(Disabled)				
000088 _H	LCD output control register 3	LOCR3	R/W	LCDC	XXXXX111 _B
000089 _H	(Disabled)				
00008A _H	A/D setting register 0	ADSR0	R/W	A/D converter	00000000 _B
00008B _H	A/D setting register 1	ADSR1	R/W		00000000 _B
00008C _H	Port input level select 0	PIL0	R/W	Port input level select	00000000 _B
00008D _H	Port input level select 1	PIL1	R/W		XXXX0000 _B
00008E _H	Port input level select 2	PIL2	R/W		XXXX0000 _B
00008F _H to 00009D _H	(Disabled)				
00009E _H	Program address detection control register	PACSR	R/W	Address match detection	XXXX0X0X _B
00009F _H	Delayed Interrupt/Release Register	DIRR	R/W	Delay interrupt	XXXXXXXX0 _B
0000A0 _H	Power saving mode control register	LPMCR	R/W	Power saving control circuit	00011000 _B
0000A1 _H	Clock select register	CKSCR	R/W, R		11111100 _B
0000A2 _H to 0000A7 _H	(Disabled)				
0000A8 _H	Watchdog timer control register	WDTC	R, W	Watchdog timer	XXXXX111 _B
0000A9 _H	Time-base timer control register	TBTC	R/W, W	Time-base timer	1XX00100 _B
0000AA _H	Watch timer control register	WTC	R/W, W, R	Watch timer (sub clock)	10001000 _B
0000AB _H to 0000AD _H	(Disabled)				
0000AE _H	Flash memory control status register	FMCS	R/W	Flash interface	000X0000 _B
0000AF _H	(Disabled)				

(Continued)

MB90920 Series

Address	Register name	Symbol	Read/write	Resource name	Initial value
0000B0 _H	Interrupt control register 00	ICR00	R/W	Interrupt controller	00000111 _B
0000B1 _H	Interrupt control register 01	ICR01	R/W		00000111 _B
0000B2 _H	Interrupt control register 02	ICR02	R/W		00000111 _B
0000B3 _H	Interrupt control register 03	ICR03	R/W		00000111 _B
0000B4 _H	Interrupt control register 04	ICR04	R/W		00000111 _B
0000B5 _H	Interrupt control register 05	ICR05	R/W		00000111 _B
0000B6 _H	Interrupt control register 06	ICR06	R/W		00000111 _B
0000B7 _H	Interrupt control register 07	ICR07	R/W		00000111 _B
0000B8 _H	Interrupt control register 08	ICR08	R/W		00000111 _B
0000B9 _H	Interrupt control register 09	ICR09	R/W		00000111 _B
0000BA _H	Interrupt control register 10	ICR10	R/W		00000111 _B
0000BB _H	Interrupt control register 11	ICR11	R/W		00000111 _B
0000BC _H	Interrupt control register 12	ICR12	R/W		00000111 _B
0000BD _H	Interrupt control register 13	ICR13	R/W		00000111 _B
0000BE _H	Interrupt control register 14	ICR14	R/W		00000111 _B
0000BF _H	Interrupt control register 15	ICR15	R/W		00000111 _B
0000C0 _H to 0000C3 _H	(Disabled)				
0000C4 _H	Serial mode register 1	SMR1	R/W, W	UART (LIN/SCI) 1	00000000 _B
0000C5 _H	Serial control register 1	SCR1	R/W, W		00000000 _B
0000C6 _H	Reception/transmission data register 1	RDR1/ TDR1	R/W		00000000 _B
0000C7 _H	Serial status register 1	SSR1	R/W, R		00001000 _B
0000C8 _H	Extended communication control register 1	ECCR1	R/W, R		000000XX _B
0000C9 _H	Extended status control register 1	ESCR1	R/W		00000100 _B
0000CA _H	Baud rate generator register 10	BGR10	R/W		00000000 _B
0000CB _H	Baud rate generator register 11	BGR11	R/W, R		00000000 _B
0000CC _H	Lower watch timer control register	WTCRL	R/W	Real-time watch timer	000XXXX0 _B
0000CD _H	Middle watch timer control register	WTCRM	R/W		00000000 _B
0000CE _H	Higher watch timer control register	WTCRH	R/W		XXXXXX00 _B
0000CF _H	Sub clock control register	PSCCR	W	Sub clock	XXXX0000 _B
0000D0 _H	Input capture control status 4/5	ICS45	R/W	Input capture 4/5	00000000 _B
0000D1 _H	Input capture edge register 4/5	ICE45	R/W, R		XXXXXXXX _B
0000D2 _H	Input capture control status 6/7	ICS67	R/W	Input capture 6/7	00000000 _B
0000D3 _H	Input capture edge register 6/7	ICE67	R/W, R		XXX0X0XX _B

(Continued)

MB90920 Series

Address	Register name	Symbol	Read/write	Resource name	Initial value
0000D4 _H	Lower timer control status register 2	TMCSR2L	R/W	16-bit reload timer 2	00000000 _B
0000D5 _H	Higher timer control status register 2	TMCSR2H	R/W		XXX10000 _B
0000D6 _H	Lower timer control status register 3	TMCSR3L	R/W	16-bit reload timer 3	00000000 _B
0000D7 _H	Higher timer control status register 3	TMCSR3H	R/W		XXX10000 _B
0000D8 _H	Lower sound control register 1	SGCRL1	R/W	Sound generator 1	00000000 _B
0000D9 _H	Higher sound control register 1	SGCRH1	R/W		0XXXX100 _B
0000DA _H	Lower PPG3 control status register	PCNTL3	R/W	16-bit PPG3	00000000 _B
0000DB _H	Higher PPG3 control status register	PCNTH3	R/W		00000001 _B
0000DC _H	Lower PPG4 control status register	PCNTL4	R/W	16-bit PPG4	00000000 _B
0000DD _H	Higher PPG4 control status register	PCNTH4	R/W		00000001 _B
0000DE _H	Lower PPG5 control status register	PCNTL5	R/W	16-bit PPG5	00000000 _B
0000DF _H	Higher PPG5 control status register	PCNTH5	R/W		00000001 _B
0000E0 _H	Serial mode register 2	SMR2	R/W, W	UART (LIN/SCI) 2	00000000 _B
0000E1 _H	Serial control register 2	SCR2	R/W, W		00000000 _B
0000E2 _H	Reception/transmission data register 2	RDR2/ TDR2	R/W		00000000 _B
0000E3 _H	Serial status register 2	SSR2	R/W, R		00001000 _B
0000E4 _H	Extended communication control register 2	ECCR2	R/W, R		000000XX _B
0000E5 _H	Extended status control register 2	ESCR2	R/W		00000100 _B
0000E6 _H	Baud rate generator register 20	BGR20	R/W		00000000 _B
0000E7 _H	Baud rate generator register 21	BGR21	R/W, R		00000000 _B
0000E8 _H	Serial mode register 3	SMR3	R/W, W		00000000 _B
0000E9 _H	Serial control register 3	SCR3	R/W, W		00000000 _B
0000EA _H	Reception/transmission data register 3	RDR3/ TDR3	R/W	00000000 _B	
0000EB _H	Serial status register 3	SSR3	R/W, R	00001000 _B	
0000EC _H	Extended communication control register 3	ECCR3	R/W, R	000000XX _B	
0000ED _H	Extended status control register 3	ESCR3	R/W	00000100 _B	
0000EE _H	Baud rate generator register 30	BGR30	R/W	00000000 _B	
0000EF _H	Baud rate generator register 31	BGR31	R/W, R	00000000 _B	
001FF0 _H	Program address detection register 0	PADR0	R/W	Address match detection	XXXXXXXX _B
001FF1 _H	Program address detection register 1	PADR0	R/W		XXXXXXXX _B
001FF2 _H	Program address detection register 2	PADR0	R/W		XXXXXXXX _B
001FF3 _H	Program address detection register 3	PADR1	R/W		XXXXXXXX _B
001FF4 _H	Program address detection register 4	PADR1	R/W		XXXXXXXX _B
001FF5 _H	Program address detection register 5	PADR1	R/W		XXXXXXXX _B

(Continued)

MB90920 Series

Address	Register name	Symbol	Read/write	Resource name	Initial value
003700 _H to 0037FF _H	Area reserved for CAN Controller 2. Refer to “■ CAN CONTROLLERS”				
003800 _H to 0038FF _H	Area reserved for CAN Controller 3. Refer to “■ CAN CONTROLLERS”				
003900 _H to 00391F _H	(Disabled)				
003920 _H	PPG0 down counter register	PDCR0	R	16-bit PPG0	11111111 _B
003921 _H					11111111 _B
003922 _H	PPG0 cycle setting register	PCSR0	W		11111111 _B
003923 _H					11111111 _B
003924 _H	PPG0 duty setting register	PDUT0	W	16-bit PPG0	00000000 _B
003925 _H					00000000 _B
003926 _H	PPG0 output division setting register	PPGDIV0	R/W, R		11111100 _B
003927 _H	(Disabled)				
003928 _H	PPG1 down counter register	PDCR1	R	16-bit PPG1	11111111 _B
003929 _H					11111111 _B
00392A _H	PPG1 cycle setting register	PCSR1	W		11111111 _B
00392B _H					11111111 _B
00392C _H	PPG1 duty setting register	PDUT1	W		00000000 _B
00392D _H					00000000 _B
00392E _H	PPG1 output division setting register	PPGDIV1	R/W, R	11111100 _B	
00392F _H	(Disabled)				
003930 _H	PPG2 down counter register	PDCR2	R	16-bit PPG2	11111111 _B
003931 _H					11111111 _B
003932 _H	PPG2 cycle setting register	PCSR2	W		11111111 _B
003933 _H					11111111 _B
003934 _H	PPG2 duty setting register	PDUT2	W		00000000 _B
003935 _H					00000000 _B
003936 _H	PPG2 output division setting register	PPGDIV2	R/W, R	11111100 _B	
003937 _H to 00393F _H	(Disabled)				
003940 _H	Input capture register 4	IPCP4	R	Input capture 4/5	XXXXXXXX _B
003941 _H					XXXXXXXX _B
003942 _H	Input capture register 5	IPCP5	R		XXXXXXXX _B
003943 _H					XXXXXXXX _B

(Continued)

MB90920 Series

Address	Register name	Symbol	Read/write	Resource name	Initial value
003944 _H	Input capture register 6	IPCP6	R	Input capture 6/7	XXXXXXXX _B
003945 _H					XXXXXXXX _B
003946 _H	Input capture register 7	IPCP7	R		XXXXXXXX _B
003947 _H					XXXXXXXX _B
003948 _H to 00394F _H	(Disabled)				
003950 _H	Minute data register 2/Reload register 2	TMR2/ TMRLR2	R/W	16-bit reload timer 2	XXXXXXXX _B
003951 _H					XXXXXXXX _B
003952 _H	Minute data register 3/Reload register 3	TMR3/ TMRLR3	R/W	16-bit reload timer 3	XXXXXXXX _B
003953 _H					XXXXXXXX _B
003954 _H to 003957 _H	(Disabled)				
003958 _H	Sub second data register	WTBR	R/W	Real time watch timer	XXXXXXXX _B
003959 _H					XXXXXXXX _B
00395A _H					XXXXXXXX _B
00395B _H	Second data register	WTSR	R/W		XX000000 _B
00395C _H	Minute data register	WTMR	R/W		XX000000 _B
00395D _H	Hour data register	WTHR	R/W		XXX00000 _B
00395E _H	Day data register	WTDR	R/W		00X00001 _B
00395F _H	(Disabled)				
003960 _H	LCD display RAM	VRAM	R/W	LCD controller/ driver	XXXXXXXX _B
003961 _H					XXXXXXXX _B
003962 _H					XXXXXXXX _B
003963 _H					XXXXXXXX _B
003964 _H					XXXXXXXX _B
003965 _H					XXXXXXXX _B
003966 _H					XXXXXXXX _B
003967 _H					XXXXXXXX _B
003968 _H					XXXXXXXX _B
003969 _H					XXXXXXXX _B
00396A _H					XXXXXXXX _B
00396B _H					XXXXXXXX _B
00396C _H					XXXXXXXX _B
00396D _H					XXXXXXXX _B
00396E _H					XXXXXXXX _B
00396F _H	XXXXXXXX _B				

(Continued)

MB90920 Series

Address	Register name	Symbol	Read/write	Resource name	Initial value
003970 _H to 003973 _H	(Disabled)				
003974 _H	Frequency data register 1	SGFR1	R/W	Sound generator 1	XXXXXXXX _B
003975 _H	Amplitude data register 1	SGAR1	R/W		0000000 _B
003976 _H	Decrement grade register 1	SGDR1	R/W		XXXXXXXX _B
003977 _H	Tone count register 1	SGTR1	R/W		XXXXXXXX _B
003978 _H to 00397F _H	(Disabled)				
003980 _H	PWM1 compare register 0	PWC10	R/W	Stepping motor controller 0	XXXXXXXX _B
003981 _H					XXXXXXXX _B
003982 _H	PWM2 compare register 0	PWC20	R/W		XXXXXXXX _B
003983 _H					XXXXXXXX _B
003984 _H	PWM1 select register 0	PWS10	R/W		0000000 _B
003985 _H	PWM2 select register 0	PWS20	R/W		X000000 _B
003986 _H , 003987 _H	(Disabled)				
003988 _H	PWM1 compare register 1	PWC11	R/W	Stepping motor controller 1	XXXXXXXX _B
003989 _H					XXXXXXXX _B
00398A _H	PWM2 compare register 1	PWC21	R/W		XXXXXXXX _B
00398B _H					XXXXXXXX _B
00398C _H	PWM1 select register 1	PWS11	R/W		0000000 _B
00398D _H	PWM2 select register 1	PWS21	R/W		X000000 _B
00398E _H , 00398F _H	(Disabled)				
003990 _H	PWM1 compare register 2	PWC12	R/W	Stepping motor controller 2	XXXXXXXX _B
003991 _H					XXXXXXXX _B
003992 _H	PWM2 compare register 2	PWC22	R/W		XXXXXXXX _B
003993 _H					XXXXXXXX _B
003994 _H	PWM1 select register 2	PWS12	R/W		0000000 _B
003995 _H	PWM2 select register 2	PWS22	R/W		X000000 _B
003996 _H , 003997 _H	(Disabled)				

(Continued)

MB90920 Series

(Continued)

Address	Register name	Symbol	Read/write	Resource name	Initial value
003998 _H	PWM1 compare register 3	PWC13	R/W	Stepping motor controller 3	XXXXXXXX _B
003999 _H					XXXXXXXX _B
00399A _H	PWM2 compare register 3	PWC23	R/W		XXXXXXXX _B
00399B _H					XXXXXXXX _B
00399C _H	PWM1 select register 3	PWS13	R/W		00000000 _B
00399D _H	PWM2 select register 3	PWS23	R/W		X0000000 _B
00399E _H to 0039A5 _H	(Disabled)				
0039A6 _H	Flash write control register 0	FWR0	R/W	Flash I/F	00000000 _B
0039A7 _H	Flash write control register 1	FWR1			00000000 _B
0039A8 _H to 0039BF _H	(Disabled)				
0039C0 _H to 0039DF _H	Area reserved for CAN Controller 2. Refer to “■ CAN CONTROLLERS”				
0039E0 _H to 0039FF _H	Area reserved for CAN Controller 3. Refer to “■ CAN CONTROLLERS”				
003A00 _H to 003AFF _H	Area reserved for CAN Controller 0. Refer to “■ CAN CONTROLLERS”				
003B00 _H to 003BFF _H	Area reserved for CAN Controller 1. Refer to “■ CAN CONTROLLERS”				
003C00 _H to 003CFF _H	Area reserved for CAN Controller 0. Refer to “■ CAN CONTROLLERS”				
003D00 _H to 003DFF _H	Area reserved for CAN Controller 1. Refer to “■ CAN CONTROLLERS”				
003E00 _H to 003EFF _H	Area reserved for CAN Controller 2. Refer to “■ CAN CONTROLLERS”				
003F00 _H to 003FFF _H	Area reserved for CAN Controller 3. Refer to “■ CAN CONTROLLERS”				

■ CAN CONTROLLERS

The CAN controller has the following features :

- Conforms to CAN Specification Version 2.0 Part A and B
 - Supports transmission/reception in standard frame and extended frame formats
- Supports transmission of data frames by receiving remote frames
- 16 transmission/reception message buffers
 - 29-bit ID and 8-byte data
 - Multi-level message buffer configuration
- Provides full-bit comparison, full-bit mask, acceptance register 0/acceptance register 1 for each message buffer as ID acceptance mask
 - 2 acceptance mask registers in either standard frame format or extended frame formats
- Bit rate programmable from 10 kbps to 2 Mbps (when input clock is at 16 MHz)

List of Control Registers(1)

Address				Register	Abbreviation	Access	Initial Value
CAN0	CAN1	CAN2	CAN3				
003C00 _H	003D00 _H	003E00 _H	003F00 _H	Control status register	CSR	R/W, R	00---000 _B 0----0-1 _B
003C01 _H	003D01 _H	003E01 _H	003F01 _H				
003C02 _H	003D02 _H	003E02 _H	003F02 _H	Last event indicator register	LEIR	R/W	----- _B 000-0000 _B
003C03 _H	003D03 _H	003E03 _H	003F03 _H				
003C04 _H	003D04 _H	003E04 _H	003F04 _H	RX/TX error counter	RTEC	R	00000000 _B 00000000 _B
003C05 _H	003D05 _H	003E05 _H	003F05 _H				
003C06 _H	003D06 _H	003E06 _H	003F06 _H	Bit timing register	BTR	R/W	-1111111 _B 11111111 _B
003C07 _H	003D07 _H	003E07 _H	003F07 _H				

MB90920 Series

List of Control Registers(2)

Address				Register	Abbreviation	Access	Initial Value
CAN0	CAN1	CAN2	CAN3				
000040 _H	000070 _H	0039C0 _H	0039D0 _H	Message buffer valid register	BVALR	R/W	00000000 _B 00000000 _B
000041 _H	000071 _H	0039C1 _H	0039D1 _H				
000042 _H	000072 _H	0039C2 _H	0039D2 _H	Transmit request register	TREQR	R/W	00000000 _B 00000000 _B
000043 _H	000073 _H	0039C3 _H	0039D3 _H				
000044 _H	000074 _H	0039C4 _H	0039D4 _H	Transmit cancel register	TCANR	W	00000000 _B 00000000 _B
000045 _H	000075 _H	0039C5 _H	0039D5 _H				
000046 _H	000076 _H	0039C6 _H	0039D6 _H	Transmit complete register	TCR	R/W	00000000 _B 00000000 _B
000047 _H	000077 _H	0039C7 _H	0039D7 _H				
000048 _H	000078 _H	0039C8 _H	0039D8 _H	Receive complete register	RCR	R/W	00000000 _B 00000000 _B
000049 _H	000079 _H	0039C9 _H	0039D9 _H				
00004A _H	00007A _H	0039CA _H	0039DA _H	Remote request receive register	RRTRR	R/W	00000000 _B 00000000 _B
00004B _H	00007B _H	0039CB _H	0039DB _H				
00004C _H	00007C _H	0039CC _H	0039DC _H	Receive overrun register	ROVRR	R/W	00000000 _B 00000000 _B
00004D _H	00007D _H	0039CD _H	0039DD _H				
00004E _H	00007E _H	0039CE _H	0039DE _H	Receive interrupt enable register	RIER	R/W	00000000 _B 00000000 _B
00004F _H	00007F _H	0039CF _H	0039DF _H				
003C08 _H	003D08 _H	003E08 _H	003F08 _H	IDE register	IDER	R/W	XXXXXXXX _B
003C09 _H	003D09 _H	003E09 _H	003F09 _H				XXXXXXXX _B
003C0A _H	003D0A _H	003E0A _H	003F0A _H	Transmit RTR register	TRTRR	R/W	00000000 _B
003C0B _H	003D0B _H	003E0B _H	003F0B _H				00000000 _B
003C0C _H	003D0C _H	003E0C _H	003F0C _H	Remote frame receive wait register	RFWTR	R/W	XXXXXXXX _B
003C0D _H	003D0D _H	003E0D _H	003F0D _H				XXXXXXXX _B
003C0E _H	003D0E _H	003E0E _H	003F0E _H	Transmit interrupt enable register	TIER	R/W	00000000 _B
003C0F _H	003D0F _H	003E0F _H	003F0F _H				00000000 _B
003C10 _H	003D10 _H	003E10 _H	003F10 _H	Acceptance mask select register	AMSR	R/W	XXXXXXXX _B
003C11 _H	003D11 _H	003E11 _H	003F11 _H				XXXXXXXX _B
003C12 _H	003D12 _H	003E12 _H	003F12 _H				XXXXXXXX _B
003C13 _H	003D13 _H	003E13 _H	003F13 _H				XXXXXXXX _B
003C14 _H	003D14 _H	003E14 _H	003F14 _H	Acceptance mask register 0	AMR0	R/W	XXXXXXXX _B
003C15 _H	003D15 _H	003E15 _H	003F15 _H				XXXXXXXX _B
003C16 _H	003D16 _H	003E16 _H	003F16 _H				XXXXXX--- _B
003C17 _H	003D17 _H	003E17 _H	003F17 _H				XXXXXXXX _B
003C18 _H	003D18 _H	003E18 _H	003F18 _H	Acceptance mask register 1	AMR1	R/W	XXXXXXXX _B
003C19 _H	003D19 _H	003E19 _H	003F19 _H				XXXXXXXX _B
003C1A _H	003D1A _H	003E1A _H	003F1A _H				XXXXXX--- _B
003C1B _H	003D1B _H	003E1B _H	003F1B _H				XXXXXXXX _B

List of Message Buffers (ID Registers)

Address				Register	Abbreviation	Access	Initial Value
CAN0	CAN1	CAN2	CAN3				
003A00 _H to 003A1F _H	003B00 _H to 003B1F _H	003700 _H to 00371F _H	003800 _H to 00381F _H	General-purpose RAM	—	R/W	XXXXXXXX _B to XXXXXXXX _B
003A20 _H	003B20 _H	003720 _H	003820 _H	ID register 0	IDR0	R/W	XXXXXXXX _B XXXXXXXX _B
003A21 _H	003B21 _H	003721 _H	003821 _H				XXXXX--- _B XXXXXXXX _B
003A22 _H	003B22 _H	003722 _H	003822 _H				
003A23 _H	003B23 _H	003723 _H	003823 _H				
003A24 _H	003B24 _H	003724 _H	003824 _H	ID register 1	IDR1	R/W	XXXXXXXX _B XXXXXXXX _B
003A25 _H	003B25 _H	003725 _H	003825 _H				XXXXX--- _B XXXXXXXX _B
003A26 _H	003B26 _H	003726 _H	003826 _H				
003A27 _H	003B27 _H	003727 _H	003827 _H				
003A28 _H	003B28 _H	003728 _H	003828 _H	ID register 2	IDR2	R/W	XXXXXXXX _B XXXXXXXX _B
003A29 _H	003B29 _H	003729 _H	003829 _H				XXXXX--- _B XXXXXXXX _B
003A2A _H	003B2A _H	00372A _H	00382A _H				
003A2B _H	003B2B _H	00372B _H	00382B _H				
003A2C _H	003B2C _H	00372C _H	00382C _H	ID register 3	IDR3	R/W	XXXXXXXX _B XXXXXXXX _B
003A2D _H	003B2D _H	00372D _H	00382D _H				XXXXX--- _B XXXXXXXX _B
003A2E _H	003B2E _H	00372E _H	00382E _H				
003A2F _H	003B2F _H	00372F _H	00382F _H				
003A30 _H	003B30 _H	003730 _H	003830 _H	ID register 4	IDR4	R/W	XXXXXXXX _B XXXXXXXX _B
003A31 _H	003B31 _H	003731 _H	003831 _H				XXXXX--- _B XXXXXXXX _B
003A32 _H	003B32 _H	003732 _H	003832 _H				
003A33 _H	003B33 _H	003733 _H	003833 _H				
003A34 _H	003B34 _H	003734 _H	003834 _H	ID register 5	IDR5	R/W	XXXXXXXX _B XXXXXXXX _B
003A35 _H	003B35 _H	003735 _H	003835 _H				XXXXX--- _B XXXXXXXX _B
003A36 _H	003B36 _H	003736 _H	003836 _H				
003A37 _H	003B37 _H	003737 _H	003837 _H				
003A38 _H	003B38 _H	003738 _H	003838 _H	ID register 6	IDR6	R/W	XXXXXXXX _B XXXXXXXX _B
003A39 _H	003B39 _H	003739 _H	003839 _H				XXXXX--- _B XXXXXXXX _B
003A3A _H	003B3A _H	00373A _H	00383A _H				
003A3B _H	003B3B _H	00373B _H	00383B _H				
003A3C _H	003B3C _H	00373C _H	00383C _H	ID register 7	IDR7	R/W	XXXXXXXX _B XXXXXXXX _B
003A3D _H	003B3D _H	00373D _H	00383D _H				XXXXX--- _B XXXXXXXX _B
003A3E _H	003B3E _H	00373E _H	00383E _H				
003A3F _H	003B3F _H	00373F _H	00383F _H				

(Continued)

MB90920 Series

(Continued)

Address				Register	Abbreviation	Access	Initial Value
CAN0	CAN1	CAN2	CAN3				
003A40 _H	003B40 _H	003740 _H	003840 _H	ID register 8	IDR8	R/W	XXXXXXXX _B XXXXXXXX _B
003A41 _H	003B41 _H	003741 _H	003841 _H				
003A42 _H	003B42 _H	003742 _H	003842 _H				
003A43 _H	003B43 _H	003743 _H	003843 _H				XXXXX _B --- XXXXXXXX _B
003A44 _H	003B44 _H	003744 _H	003844 _H	ID register 9	IDR9	R/W	XXXXXXXX _B XXXXXXXX _B
003A45 _H	003B45 _H	003745 _H	003845 _H				
003A46 _H	003B46 _H	003746 _H	003846 _H				
003A47 _H	003B47 _H	003747 _H	003847 _H				XXXXX _B --- XXXXXXXX _B
003A48 _H	003B48 _H	003748 _H	003848 _H	ID register 10	IDR10	R/W	XXXXXXXX _B XXXXXXXX _B
003A49 _H	003B49 _H	003749 _H	003849 _H				
003A4A _H	003B4A _H	00374A _H	00384A _H				
003A4B _H	003B4B _H	00374B _H	00384B _H				XXXXX _B --- XXXXXXXX _B
003A4C _H	003B4C _H	00374C _H	00384C _H	ID register 11	IDR11	R/W	XXXXXXXX _B XXXXXXXX _B
003A4D _H	003B4D _H	00374D _H	00384D _H				
003A4E _H	003B4E _H	00374E _H	00384E _H				
003A4F _H	003B4F _H	00374F _H	00384F _H				XXXXX _B --- XXXXXXXX _B
003A50 _H	003B50 _H	003750 _H	003850 _H	ID register 12	IDR12	R/W	XXXXXXXX _B XXXXXXXX _B
003A51 _H	003B51 _H	003751 _H	003851 _H				
003A52 _H	003B52 _H	003752 _H	003852 _H				
003A53 _H	003B53 _H	003753 _H	003853 _H				XXXXX _B --- XXXXXXXX _B
003A54 _H	003B54 _H	003754 _H	003854 _H	ID register 13	IDR13	R/W	XXXXXXXX _B XXXXXXXX _B
003A55 _H	003B55 _H	003755 _H	003855 _H				
003A56 _H	003B56 _H	003756 _H	003856 _H				
003A57 _H	003B57 _H	003757 _H	003857 _H				XXXXX _B --- XXXXXXXX _B
003A58 _H	003B58 _H	003758 _H	003858 _H	ID register 14	IDR14	R/W	XXXXXXXX _B XXXXXXXX _B
003A59 _H	003B59 _H	003759 _H	003859 _H				
003A5A _H	003B5A _H	00375A _H	00385A _H				
003A5B _H	003B5B _H	00375B _H	00385B _H				XXXXX _B --- XXXXXXXX _B
003A5C _H	003B5C _H	00375C _H	00385C _H	ID register 15	IDR15	R/W	XXXXXXXX _B XXXXXXXX _B
003A5D _H	003B5D _H	00375D _H	00385D _H				
003A5E _H	003B5E _H	00375E _H	00385E _H				
003A5F _H	003B5F _H	00375F _H	00385F _H				XXXXX _B --- XXXXXXXX _B

List of Message Buffers (DLC Registers)

Address				Register	Abbreviation	Access	Initial Value
CAN0	CAN1	CAN2	CAN3				
003A60 _H	003B60 _H	003760 _H	003860 _H	DLC register 0	DLCR0	R/W	----XXXX _B
003A61 _H	003B61 _H	003761 _H	003861 _H				
003A62 _H	003B62 _H	003762 _H	003862 _H	DLC register 1	DLCR1	R/W	----XXXX _B
003A63 _H	003B63 _H	003763 _H	003863 _H				
003A64 _H	003B64 _H	003764 _H	003864 _H	DLC register 2	DLCR2	R/W	----XXXX _B
003A65 _H	003B65 _H	003765 _H	003865 _H				
003A66 _H	003B66 _H	003766 _H	003866 _H	DLC register 3	DLCR3	R/W	----XXXX _B
003A67 _H	003B67 _H	003767 _H	003867 _H				
003A68 _H	003B68 _H	003768 _H	003868 _H	DLC register 4	DLCR4	R/W	----XXXX _B
003A69 _H	003B69 _H	003769 _H	003869 _H				
003A6A _H	003B6A _H	00376A _H	00386A _H	DLC register 5	DLCR5	R/W	----XXXX _B
003A6B _H	003B6B _H	00376B _H	00386B _H				
003A6C _H	003B6C _H	00376C _H	00386C _H	DLC register 6	DLCR6	R/W	----XXXX _B
003A6D _H	003B6D _H	00376D _H	00386D _H				
003A6E _H	003B6E _H	00376E _H	00386E _H	DLC register 7	DLCR7	R/W	----XXXX _B
003A6F _H	003B6F _H	00376F _H	00386F _H				
003A70 _H	003B70 _H	003770 _H	003870 _H	DLC register 8	DLCR8	R/W	----XXXX _B
003A71 _H	003B71 _H	003771 _H	003871 _H				
003A72 _H	003B72 _H	003772 _H	003872 _H	DLC register 9	DLCR9	R/W	----XXXX _B
003A73 _H	003B73 _H	003773 _H	003873 _H				
003A74 _H	003B74 _H	003774 _H	003874 _H	DLC register 10	DLCR10	R/W	----XXXX _B
003A75 _H	003B75 _H	003775 _H	003875 _H				
003A76 _H	003B76 _H	003776 _H	003876 _H	DLC register 11	DLCR11	R/W	----XXXX _B
003A77 _H	003B77 _H	003777 _H	003877 _H				
003A78 _H	003B78 _H	003778 _H	003878 _H	DLC register 12	DLCR12	R/W	----XXXX _B
003A79 _H	003B79 _H	003779 _H	003879 _H				
003A7A _H	003B7A _H	00377A _H	00387A _H	DLC register 13	DLCR13	R/W	----XXXX _B
003A7B _H	003B7B _H	00377B _H	00387B _H				
003A7C _H	003B7C _H	00377C _H	00387C _H	DLC register 14	DLCR14	R/W	----XXXX _B
003A7D _H	003B7D _H	00377D _H	00387D _H				
003A7E _H	003B7E _H	00377E _H	00387E _H	DLC register 15	DLCR15	R/W	----XXXX _B
003A7F _H	003B7F _H	00377F _H	00387F _H				

MB90920 Series

List of Message Buffers (Data register)

Address				Register	Abbreviation	Access	Initial Value
CAN0	CAN1	CAN2	CAN3				
003A80 _H to 003A87 _H	003B80 _H to 003B87 _H	003780 _H to 003787 _H	003880 _H to 003887 _H	Data register 0 (8 bytes)	DTR0	R/W	XXXXXXXX _B to XXXXXXXX _B
003A88 _H to 003A8F _H	003B88 _H to 003B8F _H	003788 _H to 00378F _H	003888 _H to 00388F _H	Data register 1 (8 bytes)	DTR1	R/W	XXXXXXXX _B to XXXXXXXX _B
003A90 _H to 003A97 _H	003B90 _H to 003B97 _H	003790 _H to 003797 _H	003890 _H to 003897 _H	Data register 2 (8 bytes)	DTR2	R/W	XXXXXXXX _B to XXXXXXXX _B
003A98 _H to 003A9F _H	003B98 _H to 003B9F _H	003798 _H to 00379F _H	003898 _H to 00389F _H	Data register 3 (8 bytes)	DTR3	R/W	XXXXXXXX _B to XXXXXXXX _B
003AA0 _H to 003AA7 _H	003BA0 _H to 003BA7 _H	0037A0 _H to 0037A7 _H	0038A0 _H to 0038A7 _H	Data register 4 (8 bytes)	DTR4	R/W	XXXXXXXX _B to XXXXXXXX _B
003AA8 _H to 003AAF _H	003BA8 _H to 003BAF _H	0037A8 _H to 0037AF _H	0038A8 _H to 0038AF _H	Data register 5 (8 bytes)	DTR5	R/W	XXXXXXXX _B to XXXXXXXX _B
003AB0 _H to 003AB7 _H	003BB0 _H to 003BB7 _H	0037B0 _H to 0037B7 _H	0038B0 _H to 0038B7 _H	Data register 6 (8 bytes)	DTR6	R/W	XXXXXXXX _B to XXXXXXXX _B
003AB8 _H to 003ABF _H	003BB8 _H to 003BBF _H	0037B8 _H to 0037BF _H	0038B8 _H to 0038BF _H	Data register 7 (8 bytes)	DTR7	R/W	XXXXXXXX _B to XXXXXXXX _B
003AC0 _H to 003AC7 _H	003BC0 _H to 003BC7 _H	0037C0 _H to 0037C7 _H	0038C0 _H to 0038C7 _H	Data register 8 (8 bytes)	DTR8	R/W	XXXXXXXX _B to XXXXXXXX _B
003AC8 _H to 003ACF _H	003BC8 _H to 003BCF _H	0037C8 _H to 0037CF _H	0038C8 _H to 0038CF _H	Data register 9 (8 bytes)	DTR9	R/W	XXXXXXXX _B to XXXXXXXX _B
003AD0 _H to 003AD7 _H	003BD0 _H to 003BD7 _H	0037D0 _H to 0037D7 _H	0038D0 _H to 0038D7 _H	Data register 10 (8 bytes)	DTR10	R/W	XXXXXXXX _B to XXXXXXXX _B
003AD8 _H to 003ADF _H	003BD8 _H to 003BDF _H	0037D8 _H to 0037DF _H	0038D8 _H to 0038DF _H	Data register 11 (8 bytes)	DTR11	R/W	XXXXXXXX _B to XXXXXXXX _B
003AE0 _H to 003AE7 _H	003BE0 _H to 003BE7 _H	0037E0 _H to 0037E7 _H	0038E0 _H to 0038E7 _H	Data register 12 (8 bytes)	DTR12	R/W	XXXXXXXX _B to XXXXXXXX _B
003AE8 _H to 003AEF _H	003BE8 _H to 003BEF _H	0037E8 _H to 0037EF _H	0038E8 _H to 0038EF _H	Data register 13 (8 bytes)	DTR13	R/W	XXXXXXXX _B to XXXXXXXX _B
003AF0 _H to 003AF7 _H	003BF0 _H to 003BF7 _H	0037F0 _H to 0037F7 _H	0038F0 _H to 0038F7 _H	Data register 14 (8 bytes)	DTR14	R/W	XXXXXXXX _B to XXXXXXXX _B
003AF8 _H to 003AFF _H	003BF8 _H to 003BFF _H	0037F8 _H to 0037FF _H	0038F8 _H to 0038FF _H	Data register 15 (8 bytes)	DTR15	R/W	XXXXXXXX _B to XXXXXXXX _B

■ INTERRUPT SOURCES, INTERRUPT VECTORS, AND INTERRUPT CONTROL REGISTERS

Interrupt source	EI ² OS corresponding	Interrupt vector		Interrupt control register		Priority *2	
		Number	Address	ICR	Address		
Reset	×	#08	08 _H	FFFFDC _H	—	<div style="display: flex; flex-direction: column; align-items: center;"> High ↑ ↓ Low </div>	
INT9 instruction	×	#09	09 _H	FFFFD8 _H	—		
Exception processing	×	#10	0A _H	FFFFD4 _H	—		
CAN0 received/CAN2 received	×	#11	0B _H	FFFFD0 _H	ICR00		0000B0 _H *1
CAN0 transmitted/node status/ CAN2 transmitted/node status	×	#12	0C _H	FFFFCC _H			
CAN1 received/CAN3 received	×	#13	0D _H	FFFFC8 _H	ICR01		0000B1 _H *1
CAN1 transmitted/node status/ CAN3 transmitted/node status/SIO	×	#14	0E _H	FFFFC4 _H			
Input capture 0	△	#15	0F _H	FFFFC0 _H	ICR02		0000B2 _H *1
DTP/ external interrupt - ch.0/ch.1 detected	△	#16	10 _H	FFFFBC _H			
Reload timer 0	△	#17	11 _H	FFFFB8 _H	ICR03		0000B3 _H *1
Reload timer 2	△	#18	12 _H	FFFFB4 _H			
Input capture 1	△	#19	13 _H	FFFFB0 _H	ICR04		0000B4 _H *1
DTP/ external interrupt - ch.2/ch.3 detected	△	#20	14 _H	FFFFAC _H			
Input capture 2	△	#21	15 _H	FFFFA8 _H	ICR05		0000B5 _H *1
Reload timer 3	△	#22	16 _H	FFFFA4 _H			
Input capture 3/4/5/6/7	△	#23	17 _H	FFFFA0 _H	ICR06		0000B6 _H *1
DTP/ external interrupt - ch.4/ ch.5 detected UART3 RX	△	#24	18 _H	FFFF9C _H			
PPG timer 0	△	#25	19 _H	FFFF98 _H	ICR07		0000B7 _H *1
DTP/ external interrupt - ch.6/ ch.7 detected UART3 TX	△	#26	1A _H	FFFF94 _H			
PPG timer 1	△	#27	1B _H	FFFF90 _H	ICR08		0000B8 _H *1
Reload timer 1	△	#28	1C _H	FFFF8C _H			
PPG timer 2/3/4/5	○	#29	1D _H	FFFF88 _H	ICR09		0000B9 _H *1
Real time watch timer watch timer (sub clock)	×	#30	1E _H	FFFF84 _H			
Free-run timer overflow/clear	×	#31	1F _H	FFFF80 _H	ICR10		0000BA _H *1
A/D converter conversion complete	○	#32	20 _H	FFFF7C _H			
Sound generator 0/1	×	#33	21 _H	FFFF78 _H	ICR11		0000BB _H *1
Time-base timer	×	#34	22 _H	FFFF74 _H			
UART2 RX	○	#35	23 _H	FFFF70 _H	ICR12		0000BC _H *1
UART2 TX	△	#36	24 _H	FFFF6C _H			

(Continued)

MB90920 Series

(Continued)

Interrupt source	EI ² OS corresponding	Interrupt vector			Interrupt control register		Priority ^{*2}
		Number	Address	Address	ICR	Address	
UART 1 RX	◎	#37	25 _H	FFFF68 _H	ICR13	0000BD _H ^{*1}	High ↑ ↓ Low
UART 1 TX	△	#38	26 _H	FFFF64 _H			
UART 0 RX	◎	#39	27 _H	FFFF60 _H	ICR14	0000BE _H ^{*1}	
UART 0 TX	△	#40	28 _H	FFFF5C _H			
Flash memory status	×	#41	29 _H	FFFF58 _H	ICR15	0000BF _H ^{*1}	
Delay interrupt generator module	×	#42	2A _H	FFFF54 _H			

◎ : Usable, and has expanded intelligent I/O services (EI²OS) stop function

○ : Usable

△ : Usable when interrupt sources sharing ICR are not in use

×

*1 : • Peripheral functions that share the ICR register have the same interrupt level.

• If the expanded intelligent I/O service (EI²OS) is used with peripheral functions that share the ICR register, only one of the peripheral functions that share the register can be used.

• When the expanded intelligent I/O service (EI²OS) is specified for one of the peripheral functions that shares the ICR register, interrupts cannot be used from the other peripheral functions that share the register.

*2 : Priority applies when interrupts of the same level are generated.

■ ELECTRICAL CHARACTERISTICS

1. Absolute Maximum Ratings

Parameter	Symbol	Rating		Unit	Remarks
		Min	Max		
Power supply voltage*1	V _{CC}	V _{SS} - 0.3	V _{SS} + 6.0	V	
	AV _{CC}	V _{SS} - 0.3	V _{SS} + 6.0	V	AV _{CC} = V _{CC} *2
	AVRH	V _{SS} - 0.3	V _{SS} + 6.0	V	AV _{CC} ≥ AVRH*2
	DV _{CC}	V _{SS} - 0.3	V _{SS} + 6.0	V	DV _{CC} = V _{CC} *2
Input voltage*1	V _I	V _{SS} - 0.3	V _{CC} + 0.3	V	*3
Output voltage*1	V _O	V _{SS} - 0.3	V _{CC} + 0.3	V	
Maximum clamp current	I _{CLAMP}	- 4	+ 4	mA	*7
Total maximum clamp current	Σ I _{CLAMP}	—	40	mA	*7
“L” level maximum output current*4	I _{OL1}	—	15	mA	Except P70 to P77 and P80 to P87
	I _{OL2}	—	40	mA	P70 to P77 and P80 to P87
“L” level average output current*5	I _{OLAV1}	—	4	mA	Except P70 to P77 and P80 to P87
	I _{OLAV2}	—	30	mA	P70 to P77 and P80 to P87
“L” level maximum total output current	ΣI _{OL1}	—	100	mA	Except P70 to P77 and P80 to P87
	ΣI _{OL2}	—	330	mA	P70 to P77 and P80 to P87
“L” level average total output current	ΣI _{OLAV1}	—	50	mA	Except P70 to P77 and P80 to P87
	ΣI _{OLAV2}	—	250	mA	P70 to P77 and P80 to P87
“H” level maximum output current	I _{OH1} *4	—	-15	mA	Except P70 to P77 and P80 to P87
	I _{OH2} *4	—	-40	mA	P70 to P77 and P80 to P87
“H” level average output current	I _{OHAV1} *5	—	-4	mA	Except P70 to P77 and P80 to P87
	I _{OHAV2} *5	—	-30	mA	P70 to P77 and P80 to P87
“H” level maximum total output current	ΣI _{OH1}	—	-100	mA	Except P70 to P77 and P80 to P87
	ΣI _{OH2}	—	-330	mA	P70 to P77 and P80 to P87
“H” level average total output current	ΣI _{OHAV1} *6	—	-50	mA	Except P70 to P77 and P80 to P87
	ΣI _{OHAV2} *6	—	-250	mA	P70 to P77 and P80 to P87
Power consumption	P _D	—	625	mW	
Operating temperature	T _A	- 40	+ 105	°C	
Storage temperature	T _{STG}	- 55	+ 150	°C	

*1 : The parameter is based on V_{SS} = AV_{SS} = DV_{SS} = 0.0 V.

*2 : AV_{CC}, AVRH must not exceed V_{CC}, and AVRH must not exceed AV_{CC}.

When using an evaluation product, DV_{CC} must not exceed V_{CC} (however, DV_{CC} can be set to a higher voltage than V_{CC} when using a Flash memory product).

*3 : If the input current or the maximum input current is limited using external components, I_{CLAMP} is the applicable rating instead of V_I.

*4 : Maximum output current is defined as the peak value of current through any one of the corresponding pins.

(Continued)

MB90920 Series

(Continued)

- *5 : Average output current is defined as the average value of the current flowing through any one of the corresponding pins within a period of 100 ms. The “average value” can be calculated by multiplying the “operating current” by the “operating factor”.
- *6 : Average total output current is defined as the average value of the current flowing through all of the corresponding pins within a period of 100 ms. The “average value” can be calculated by multiplying the “operating current” by the “operating factor”.
- *7 :
 - Applicable to pins: P10 to P15, P50 to P57, P60 to P67, P70 to P77, P80 to P87, PC0 to PC7, PD0 to PD6, PE0 to PE2
 - Use within recommended operating conditions.
 - Use at DC voltage (current) .
 - The +B signal should always be applied with a limiting resistance placed between the +B signal and the microcontroller.
 - The value of the limiting resistance should be set so that when the +B signal is applied, the input current to the microcontroller pin does not exceed rated values, either instantaneously or for prolonged periods.
 - Note that when the microcontroller drive current is low, such as in the power saving modes, the +B input potential may pass through the protective diode and increase the potential at the V_{CC} pin, and this may affect other devices.
 - Note that if a +B signal is input when the microcontroller power supply is off (not fixed at 0 V) , the microcontroller may partially malfunction on power supplied through the +B signal pin.
 - Note that if the +B input is applied during power-on, the power supply voltage may reach a level such that the power-on reset does not function due to the power supplied from the +B signal.
 - Care must be taken not to leave +B input pins open.
 - Note that analog system input/output pins (LCD drive pins, comparator input pins, etc.) cannot accept +B signal inputs.
 - Sample recommended circuit :



WARNING: Semiconductor devices can be permanently damaged by application of stress (voltage, current, temperature, etc.) in excess of absolute maximum ratings. Do not exceed these ratings.

2. Recommended Operating Conditions

($V_{SS} = DV_{SS} = AV_{SS} = 0.0\text{ V}$)

Parameter	Symbol	Value		Unit	Remarks
		Min	Max		
Power supply voltage	V_{CC}	4.0	5.5	V	The low voltage detection reset operates when the power supply voltage reaches $4.2\text{ V} \pm 0.2\text{ V}$.
	AV_{CC} DV_{CC}	4.4	5.5	V	Maintain stop operation status The low voltage detection reset operates when the power supply voltage reaches $4.2\text{ V} \pm 0.2\text{ V}$.
Smoothing capacitor*	C_s	0.1	1.0	μF	Use a ceramic capacitor or other capacitor of equivalent frequency characteristics. Use a capacitor with a capacitance greater than this capacitor as the bypass capacitor for the V_{CC} pin.
Operating temperature	T_A	- 40	+ 105	$^{\circ}\text{C}$	

* : Refer to the following diagram for details on the connection of the smoothing capacitor C_s .



WARNING: The recommended operating conditions are required in order to ensure the normal operation of the semiconductor device. All of the device's electrical characteristics are warranted when the device is operated within these ranges.

Always use semiconductor devices within their recommended operating condition ranges. Operation outside these ranges may adversely affect reliability and could result in device failure.

No warranty is made with respect to uses, operating conditions, or combinations not represented on the data sheet. Users considering application outside the listed conditions are advised to contact their representatives beforehand.

MB90920 Series

3. DC Characteristics

($V_{CC} = 5.0\text{ V} \pm 10\%$, $V_{SS} = DV_{SS} = AV_{SS} = 0.0\text{ V}$, $T_A = -40\text{ }^\circ\text{C}$ to $+105\text{ }^\circ\text{C}$)

Parameter	Symbol	Pin name	Conditions	Value			Unit	Remarks
				Min	Typ	Max		
“H” level input voltage	V_{IHA}	—	—	$0.8 V_{CC}$	—	—	V	Pin inputs if Automotive input levels are selected
	V_{IHS}	—	—	$0.8 V_{CC}$	—	—	V	Pin inputs if CMOS hysteresis input levels are selected
	V_{IHC}	—	—	$0.7 V_{CC}$	—	—	V	$\overline{\text{RST}}$ input pin (CMOS hysteresis)
“L” level input voltage	V_{ILA}	—	—	—	—	$0.5 V_{CC}$	V	Pin inputs if Automotive input levels are selected
	V_{ILS}	—	—	—	—	$0.2 V_{CC}$	V	Pin inputs if CMOS hysteresis input levels are selected
	V_{ILR}	—	—	—	—	$0.3 V_{CC}$	V	$\overline{\text{RST}}$ input pin (CMOS hysteresis)
Powersupply current*	I_{CC}	V_{CC}	Maximum operating frequency $F_{CP} = 32\text{ MHz}$, normal operation	—	35	45	mA	
			Maximum operating frequency $F_{CP} = 32\text{ MHz}$, writing Flash memory	—	55	65	mA	
	I_{CCS}		Operating frequency $F_{CP} = 32\text{ MHz}$, sleep mode	—	13	20	mA	
	I_{CTS}		Operating frequency $F_{CP} = 2\text{ MHz}$, time-base timer mode	—	0.6	1.0	mA	
	I_{CTSPLL}		Operating frequency $F_{CP} = 32\text{ MHz}$, PLL timer mode, External frequency = 4 MHz	—	2.5	4	mA	
	I_{CCL}		Operating frequency $F_{CP} = 8\text{ kHz}$, $T_A = +25\text{ }^\circ\text{C}$, sub clock operation	—	120	270	μA	
	I_{CCLS}		Operating frequency $F_{CP} = 8\text{ kHz}$, $T_A = +25\text{ }^\circ\text{C}$, sub sleep operation	—	100	200	μA	
	I_{CCT}		Operating frequency $F_{CP} = 8\text{ kHz}$, $T_A = +25\text{ }^\circ\text{C}$, watch mode	—	90	180	μA	
	I_{CCH}		$T_A = +25\text{ }^\circ\text{C}$, stop mode	—	80	170	μA	

(Continued)

MB90920 Series

($V_{CC} = 5.0\text{ V} \pm 10\%$, $V_{SS} = DV_{SS} = AV_{SS} = 0.0\text{ V}$, $T_A = -40\text{ }^\circ\text{C}$ to $+105\text{ }^\circ\text{C}$)

Parameter	Symbol	Pin name	Conditions	Value			Unit	Remarks
				Min	Typ	Max		
Input leakage current	I_{IL}	All input pins	$V_{CC} = DV_{CC} = AV_{CC} = 5.5\text{ V}$, $V_{SS} < V_I < V_{CC}$	—	—	10	μA	
Input capacitance 1	C_{IN1}	All pins except VCC, VSS, DVCC, DVSS, AVCC, AVSS, C, P70 to P77, P80 to P87	—	—	—	15	pF	
Input capacitance 2	C_{IN2}	P70 to P77, P80 to P87	—	—	—	45	pF	
Pull-up resistance	R_{UP}	\overline{RST}	—	25	50	100	k Ω	
Pull-down resistance	R_{DOWN}	MD2	—	—	—	100	k Ω	Excluding Flash memory product
General-purpose output "H" voltage	V_{OH1}	All pins except P70 to P77, P80 to P87	$V_{CC} = 4.5\text{ V}$, $I_{OH} = -4.0\text{ mA}$	$V_{CC} - 0.5$	—	—	V	
Stepping motor output "H" voltage	V_{OH2}	P70 to P77, P80 to P87	$V_{CC} = 4.5\text{ V}$, $I_{OH} = -30.0\text{ mA}$	$V_{CC} - 0.5$	—	—	V	
General-purpose output "L" voltage	V_{OL1}	All pins except P70 to P77, P80 to P87	$V_{CC} = 4.5\text{ V}$, $I_{OL} = 4.0\text{ mA}$	—	—	0.4	V	
Stepping motor output "L" voltage	V_{OL2}	P70 to P77, P80 to P87	$V_{CC} = 4.5\text{ V}$, $I_{OL} = 30.0\text{ mA}$	—	—	0.55	V	
Stepping motor output phase variation "H"	ΔV_{OH}	PWM1Pn, PWM1Mn, PWM2Pn, PWM2Mn, n = 0 to 3	$V_{CC} = 4.5\text{ V}$, $I_{OH} = -30.0\text{ mA}$, maximum deviation V_{OH2}	—	—	90	mV	
Stepping motor output phase variation "L"	ΔV_{OL}	PWM1Pn, PWM1Mn, PWM2Pn, PWM2Mn, n = 0 to 3	$V_{CC} = 4.5\text{ V}$, $I_{OL} = 30.0\text{ mA}$, maximum deviation V_{OH2}	—	—	90	mV	
LCD internal divider resistance	R_{LCD}	Between V0 and V1, Between V1 and V2, Between V2 and V3	—	50	100	200	k Ω	Evaluation product
				8.75	12.5	17.0	k Ω	Flash memory product

(Continued)

MB90920 Series

(Continued)

($V_{CC} = 5.0 \text{ V} \pm 10\%$, $V_{SS} = DV_{SS} = AV_{SS} = 0.0 \text{ V}$, $T_A = -40 \text{ }^\circ\text{C}$ to $+105 \text{ }^\circ\text{C}$)

Parameter	Symbol	Pin name	Conditions	Value			Unit	Remarks
				Min	Typ	Max		
LCDC leakage current	I_{LCDC}	V0 to V3, COMm (m = 0 to 3) , SEGN, (n = 00 to 31)	—	—	—	5.0	μA	
LCD output impedance	R_{vcom}	COMn (n = 0 to 3)	—	—	—	4.5	$\text{k}\Omega$	
	R_{vseg}	SEGN (n = 00 to 31)	—	—	—	17	$\text{k}\Omega$	

* : Power supply current values assume an external clock supplied to the X1 pin and X1A pin. Users must be aware that power supply current levels differ depending on whether an external clock or oscillator is used.

4. AC Characteristics

(1) Clock timing

($V_{CC} = 5.0\text{ V} \pm 10\%$, $V_{SS} = DV_{SS} = AV_{SS} = 0.0\text{ V}$, $T_A = -40\text{ }^\circ\text{C}$ to $+105\text{ }^\circ\text{C}$)

Parameter	Symbol	Pin name	Condi- tions	Value			Unit	Remarks
				Min	Typ	Max		
Clock frequency	F _C	X0, X1	—	3	—	16	MHz	1/2 (PLL stopped) When using the oscillator circuit
				3	—	32	MHz	1/2 (PLL stopped) When using an external clock
				4	—	32	MHz	PLL multiplied by 1
				3	—	16	MHz	PLL multiplied by 2
				3	—	10.7	MHz	PLL multiplied by 3
				3	—	8	MHz	PLL multiplied by 4
				3	—	5.33	MHz	PLL multiplied by 6
	3	—		4	MHz	PLL multiplied by 8		
	F _{LC}	X0A, X1A	—	32.768	—	kHz		
Clock cycle time	t _{CYL}	X0, X1	—	62.5	—	333	ns	When using an oscillator
				31.25	—	333	ns	External clock input
	t _{LCYL}	X0A, X1A	—	30.5	—	—	μs	
Input clock pulse width	P _{WH} , P _{WL}	X0		5	—	—	ns	Use duty ratio of 50% ± 3% as a guideline
	P _{WLH} , P _{WLL}	X0A		—	15.2	—	μs	
Input clock rise and fall time	t _{cr} , t _{cf}	X0		—	—	5	ns	When using an external clock signal
Internal operating clock frequency	F _{CP}	—		1.5	—	32	MHz	Using main clock (PLL clock)
	F _{LCP}	—		—	8.192	—	kHz	Using sub clock
Internal operating clock cycle time	t _{CP}	—		31.25	—	666	ns	Using main clock (PLL clock)
	t _{LCP}	—		—	122.1	—	μs	Using sub clock

MB90920 Series

- X0, X1 clock timing



- X0A, X1A clock timing



• Guaranteed PLL Operation Range



- Notes :
- For PLL 1 \times only, use with $t_{CP} = 4$ MHz or greater.
 - Refer to "5. A/D Converter (1) Electrical Characteristics" for details on the A/D converter operating frequency.

(Continued)

(Continued)

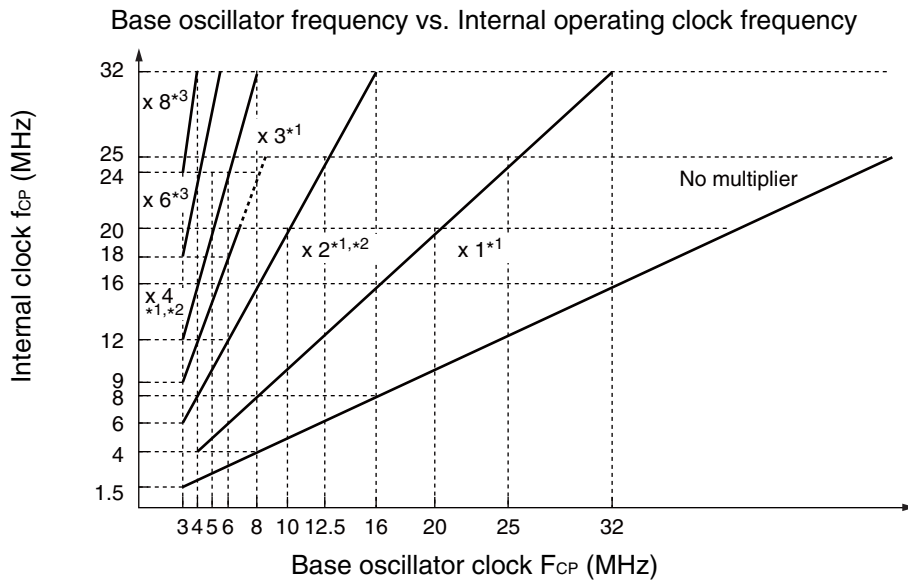

*1 : When the PLL multiplier is $\times 1$, $\times 2$, $\times 3$ or $\times 4$ and the internal clock is $20 \text{ MHz} < f_{CP} \leq 32 \text{ MHz}$, set DIV2 bit = "1"*4, CS2 bit = "1" in the PSCCR register.

[Example] When using a base oscillator frequency of 24 MHz at PLL $\times 1$:

CKSCR register : CS1 bit = "0", CS0 bit = "0"

PSCCR register : DIV2 bit = "1"*4, CS2 bit = "1"

[Example] When using a base oscillator frequency of 6 MHz at PLL $\times 3$:

CKSCR register : CS1 bit = "1", CS0 bit = "0"

PSCCR register : DIV2 bit = "1"*4, CS2 bit = "1"

*2 : When the PLL multiplier is $\times 2$ or $\times 4$ and the internal clock is $20 \text{ MHz} < f_{CP} \leq 32 \text{ MHz}$, the following settings are also supported.

PLL $\times 2$: CKSCR register : CS1 bit = "0", CS0 bit = "0"

PSCCR register : DIV2 bit = "0"*4, CS2 bit = "0"

PLL $\times 4$: CKSCR register : CS1 bit = "0", CS0 bit = "1"

PSCCR register : DIV2 bit = "0"*4, CS2 bit = "0"

*3 : When the PLL multiplier is set to $\times 6$ or $\times 8$ set "DIV2 bit = "0"*4 CS2 bit = "1" and "PLL2 bit = 1" in the PSCCR register.

[Example] When using a base oscillator frequency of 4 MHz at PLL $\times 6$:

CKSCR register : CS1 bit = "1", CS0 bit = "0"

PLLOS register : DIV2 bit = "0"*4, CS2 bit = "1"

[Example] When using a base oscillator frequency of 3 MHz at PLL $\times 8$:

CKSCR register : CS1 bit = "1", CS0 bit = "1"

PLLOS register : DIV2 bit = "0"*4, CS2 bit = "1"

*4 : The DIV2 bit is assigned to bit 9 of the PSCCR register and the CS2 bit is assigned to bit 8 of the PSCCR register. Both bits have a default value of "0".

(2) Reset input

($V_{CC} = 5.0\text{ V} \pm 10\%$, $V_{SS} = AV_{SS} = 0.0\text{ V}$, $T_A = -40\text{ }^\circ\text{C}$ to $+105\text{ }^\circ\text{C}$)

Parameter	Symbol	Pin name	Value		Unit	Remarks
			Min	Max		
Reset input time	t_{RSTL}	\overline{RST}	500	—	ns	During normal operation
			Oscillator oscillation time* + 16 t_{CP}	—	ms	In stop mode, sub clock mode, sub sleep mode, and watch mode
			100	—	μs	In time-base timer mode

*: The oscillation time of the oscillator is the time taken to reach 90% of the amplitude. The oscillation time of a crystal oscillator is between several ms and tens of ms. The oscillation time of a ceramic oscillator is between hundreds of μs and several ms. The oscillation time of an external clock is 0 ms.

Note : t_{CP} is the internal operating clock cycle time. (Unit : ns)

- During normal operation



- In stop mode, sub clock mode, sub sleep mode, watch mode, and power-on

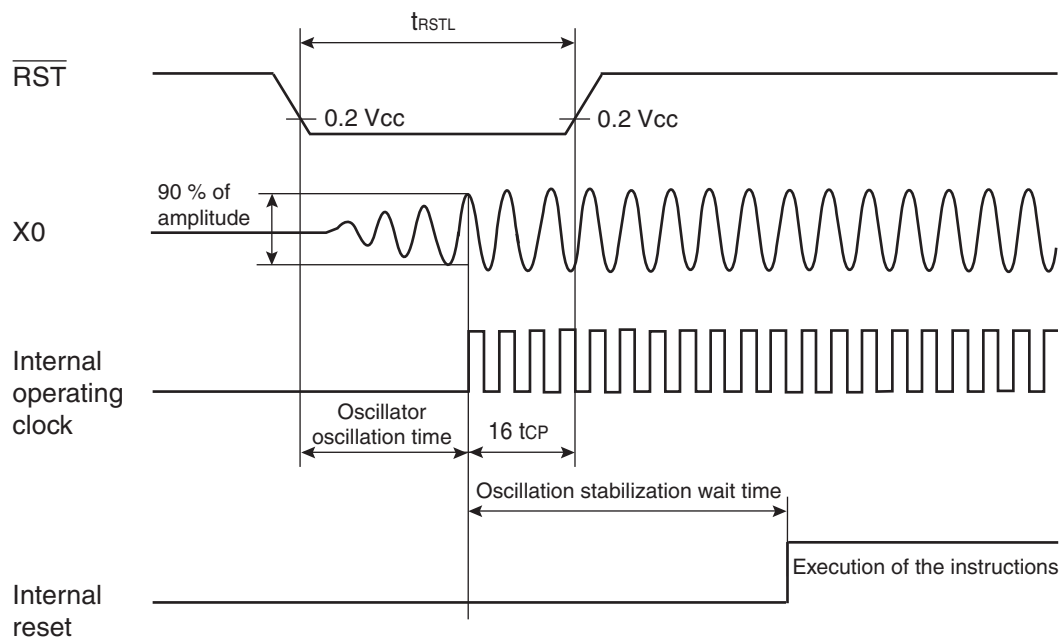

MB90920 Series

(3) Power-on reset

($V_{CC} = 2.7 \text{ V to } 3.6 \text{ V}$, $V_{SS} = 0.0 \text{ V}$, $T_A = -40 \text{ }^\circ\text{C to } +105 \text{ }^\circ\text{C}$)

Parameter	Symbol	Pin name	Conditions	Value		Unit	Remarks
				Min	Max		
Power supply rise time	t_R	VCC	—	0.05	30	ms	
Power off time	t_{OFF}			1	—	ms	Waiting time until power-on



Note : Extreme variations in power supply voltage may trigger a power-on reset. When the power supply voltage is changed during operation, it is recommended that increases in the voltage smoothed out as shown in the following diagram. The PLL clock of the device should not be in use when varying the voltage. However, the PLL clock may continue to be used if the rate of the voltage drop is 1 V/s or less.

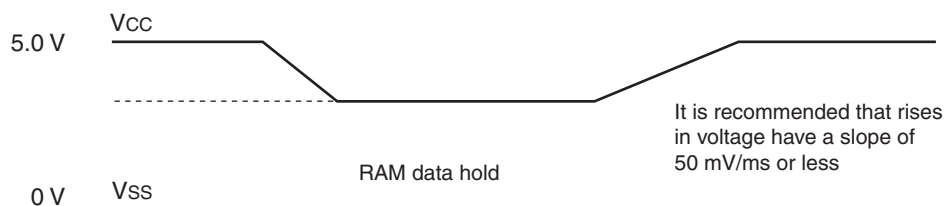

(4) UART0/1/2/3 (LIN/SCI)

- Bit setting: ESCR0/1/2/3:SCES=0, ECCR0/1/2/3:SCDE=0

($V_{CC} = 5.0 V \pm 10\%$, $V_{SS} = AV_{SS} = 0.0 V$, $T_A = -40\text{ }^\circ\text{C}$ to $+105\text{ }^\circ\text{C}$)

Parameter	Symbol	Pin name	Conditions	Value		Unit
				Min	Max	
Serial clock cycle time	t_{SCYC}	SCK0 to SCK3	Internal shift clock mode output pin $C_L = 80\text{ pF} + 1\text{TTL}$	$5 t_{CP}$	—	ns
SCK ↓ → SOT delay time	t_{SLOVI}	SCK0 to SCK3, SOT0 to SOT3		- 50	+ 50	ns
Valid SIN → SCK ↑	t_{IVSHI}	SCK0 to SCK3, SIN0 to SIN3		$t_{CP} + 80$	—	ns
SCK ↑ → valid SIN hold time	t_{SHIXI}			0	—	ns
Serial clock "L" pulse width	t_{SLSH}	SCK0 to SCK3	External shift clock mode output pin $C_L = 80\text{ pF} + 1\text{TTL}$	$3 t_{CP} - t_R$	—	ns
Serial clock "H" pulse width	t_{SHSL}			$t_{CP} + 10$	—	ns
SCK ↓ → SOT delay time	t_{SLOVE}	SCK0 to SCK3, SOT0 to SOT3		—	$2 t_{CP} + 60$	ns
Valid SIN → SCK ↑	t_{IVSHE}	SCK0 to SCK3, SIN0 to SIN3		30	—	ns
SCK ↑ → valid SIN hold time	t_{SHIXE}			$t_{CP} + 30$	—	ns
SCK ↓ time	t_F	SCK0 to SCK3		—	10	ns
SCK ↑ time	t_R			—	10	ns

Notes : • Depending on the machine clock frequency to be used, the maximum baud rate may be limited by some parameters. These parameters are shown in "MB90920 series hardware manual".

- C_L is the load capacitance connected to the pin during testing.
- t_{CP} is the internal operating clock cycle time. Refer to "(1) Clock timing".

- Internal shift clock mode



- External shift clock mode



MB90920 Series

• Bit setting: ESCR0/1/2/3:SCES=1, ECCR0/1/2/3:SCDE=0

($V_{CC} = 5.0 V \pm 10\%$, $V_{SS} = AV_{SS} = 0.0 V$, $T_A = -40\text{ }^\circ\text{C}$ to $+105\text{ }^\circ\text{C}$)

Parameter	Symbol	Pin name	Conditions	Value		Unit
				Min	Max	
Serial clock cycle time	t_{SCYC}	SCK0 to SCK3	Internal shift clock mode output pin $C_L = 80\text{ pF} + 1\text{TTL}$	$5 t_{CP}$	—	ns
SCK \uparrow \rightarrow SOT delay time	t_{SHOVI}	SCK0 to SCK3, SOT0 to SOT3		- 50	+ 50	ns
Valid SIN \rightarrow SCK \downarrow	t_{IVSLI}	SCK0 to SCK3, SIN0 to SIN3		$t_{CP} + 80$	—	ns
SCK \downarrow \rightarrow valid SIN hold time	t_{SLIXI}			0	—	ns
Serial clock "H" pulse width	t_{SHSL}	SCK0 to SCK3	External shift clock mode output pin $C_L = 80\text{ pF} + 1\text{TTL}$	$3 t_{CP} - t_R$	—	ns
Serial clock "L" pulse width	t_{LSLH}			$t_{CP} + 10$	—	ns
SCK \uparrow \rightarrow SOT delay time	t_{SHOVE}	SCK0 to SCK3, SOT0 to SOT3		—	$2 t_{CP} + 60$	ns
Valid SIN \rightarrow SCK \downarrow	t_{IVSLE}	SCK0 to SCK3, SIN0 to SIN3		30	—	ns
SCK \downarrow \rightarrow valid SIN hold time	t_{SLIXE}			$t_{CP} + 30$	—	ns
SCK \downarrow time	t_F	SCK0 to SCK3		—	10	ns
SCK \uparrow time	t_R			—	10	ns

Notes : • Depending on the machine clock frequency to be used, the maximum baud rate may be limited by some parameters. These parameters are shown in "MB90920 series hardware manual".

- C_L is the load capacitance connected to the pin during testing.
- t_{CP} is the internal operating clock cycle time. Refer to "(1) Clock timing".

- Internal shift clock mode



- External shift clock mode



• Bit setting: **ESCR0/1/2/3:SCES=0, ECCR0/1/2/3:SCDE=1**

($V_{CC} = 5.0\text{ V} \pm 10\%$, $V_{SS} = AV_{SS} = 0.0\text{ V}$, $T_A = -40\text{ }^\circ\text{C}$ to $+105\text{ }^\circ\text{C}$)

Parameter	Symbol	Pin name	Conditions	Value		Unit
				Min	Max	
Serial clock cycle time	t_{SCYC}	SCK0 to SCK3	Internal shift clock mode output pin $C_L = 80\text{ pF} + 1\text{TTL}$	$5 t_{CP}$	—	ns
SCK \uparrow \rightarrow SOT delay time	t_{SHOVI}	SCK0 to SCK3, SOT0 to SOT3		- 50	+ 50	ns
Valid SIN \rightarrow SCK \downarrow	t_{IVSLI}	SCK0 to SCK3, SIN0 to SIN3		$t_{CP} + 80$	—	ns
SCK \downarrow \rightarrow valid SIN hold time	t_{SLIXI}			0	—	ns
SOT \rightarrow SCK \downarrow delay time	t_{SOVLI}	SCK0 to SCK3, SOT0 to SOT3		$3 t_{CP} - 70$	—	ns

Notes : • Depending on the machine clock frequency to be used, the maximum baud rate may be limited by some parameters. These parameters are shown in “MB90920 series hardware manual”.

• C_L is the load capacitance connected to the pin during testing.

• t_{CP} is the internal operating clock cycle time. Refer to “(1) Clock timing”.



MB90920 Series

- Bit setting: ESCR0/1/2/3:SCES=1, ECCR0/1/2/3:SCDE=1

($V_{CC} = 5.0 \text{ V} \pm 10\%$, $V_{SS} = AV_{SS} = 0.0 \text{ V}$, $T_A = -40 \text{ }^\circ\text{C}$ to $+105 \text{ }^\circ\text{C}$)

Parameter	Symbol	Pin name	Conditions	Value		Unit
				Min	Max	
Serial clock cycle time	t_{SCYC}	SCK0 to SCK3	Internal shift clock mode output pin $C_L = 80 \text{ pF} + 1\text{TTL}$	$5 t_{CP}$	—	ns
SCK ↓ → SOT delay time	t_{SLOVI}	SCK0 to SCK3, SOT0 to SOT3		- 50	+ 50	ns
Valid SIN → SCK ↓	t_{IVSHI}	SCK0 to SCK3, SIN0 to SIN3		$t_{CP} + 80$	—	ns
SCK ↑ → valid SIN hold time	t_{SHIXI}	SCK0 to SCK3, SIN0 to SIN3		0	—	ns
SOT → SCK ↑ delay time	t_{SOVHI}	SCK0 to SCK3, SOT0 to SOT3		$3 t_{CP} - 70$	—	ns

- Notes :
- Depending on the machine clock frequency to be used, the maximum baud rate may be limited by some parameters. These parameters are shown in “MB90920 series hardware manual”.
 - C_L is the load capacitance connected to the pin during testing.
 - t_{CP} is the internal operating clock cycle time. Refer to “(1) Clock timing”.

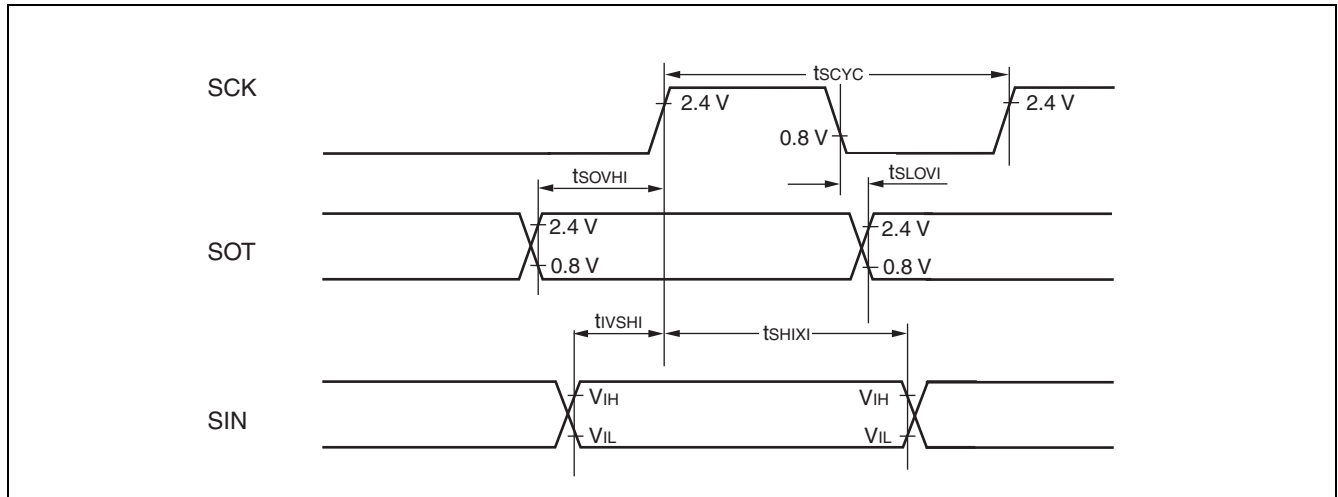

(5) Timer input timing

($V_{CC} = 5.0\text{ V} \pm 10\%$, $V_{SS} = AV_{SS} = 0.0\text{ V}$, $T_A = -40\text{ }^\circ\text{C}$ to $+105\text{ }^\circ\text{C}$)

Parameter	Symbol	Pin name	Conditions	Value		Unit
				Min	Max	
Input pulse width	t_{TIWH} t_{TIWL}	TIN0, TIN1, IN0 to IN3	—	4 t_{CP}	—	ns

Note : t_{CP} is the internal operating clock cycle time. Refer to “(1) Clock timing”.

- Timer input timing



MB90920 Series

(6) Trigger input timing

($V_{CC} = 5.0\text{ V} \pm 10\%$, $V_{SS} = AV_{SS} = 0.0\text{ V}$, $T_A = -40\text{ }^\circ\text{C}$ to $+105\text{ }^\circ\text{C}$)

Parameter	Symbol	Pin name	Conditions	Value		Unit	Remarks
				Min	Max		
Input pulse width	t_{TRGH} , t_{TRGL}	INT0 to INT7	—	200	—	ns	During normal operation
		ADTG	—	$t_{CP} + 200$	—	ns	

Note : t_{CP} is the internal operating clock cycle time. Refer to “(1) Clock timing”.

- Trigger input timing

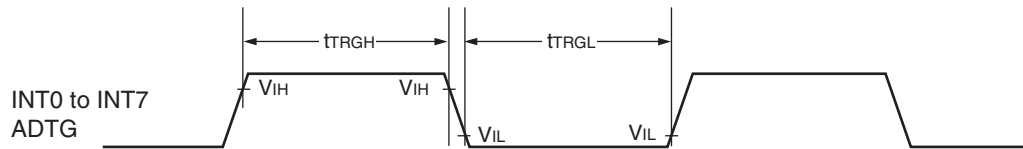

(7) Low voltage detection

($V_{SS} = AV_{SS} = 0.0\text{ V}$, $T_A = -40\text{ }^\circ\text{C}$ to $+105\text{ }^\circ\text{C}$)

Parameter	Symbol	Pin name	Conditions	Value			Unit	Remarks
				Min	Typ	Max		
Detection voltage	V_{DL}	VCC	—	4.0	4.2	4.4	V	Flash memory product, during voltage drop
				3.7	4.0	4.3	V	Evaluation product, during voltage drop
Hysteresis width	V_{HYS}	VCC	—	190	—	—	mV	Flash memory product, during voltage rise
				0.1	—	—	V	Evaluation product, during voltage rise
Power supply voltage change rate	dV/dt	VCC	—	-0.1	—	+0.1	V/ μs	Flash memory product, dV/dt at low voltage reset
				-0.004	—	+0.004	V/ μs	Flash memory product, dV/dt at standard value of low voltage detection/release voltage
				-0.1	—	+0.02	V/ μs	Evaluation product
Detection delay time	t_d	—	—	—	—	3.2	μs	Flash memory product, when dV/dt \leq 0.004 V/ μs
				—	—	35	μs	Evaluation product

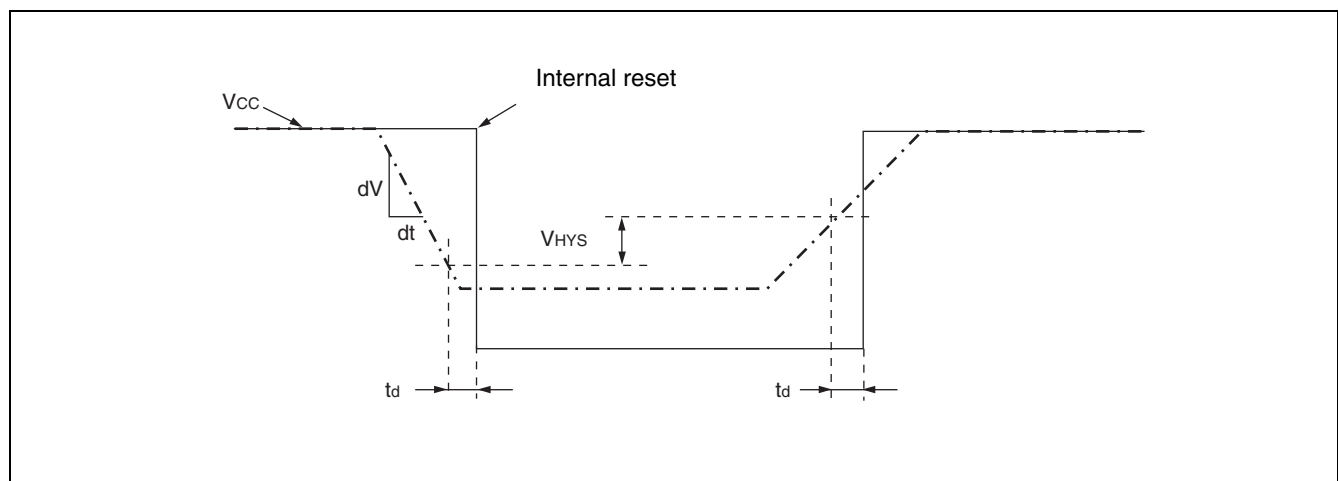

MB90920 Series

5. A/D Converter

(1) Electrical Characteristics

($V_{CC} = AV_{CC} = AVRH = 4.0\text{ V to }5.5\text{ V}$, $V_{SS} = AV_{SS} = 0.0\text{ V}$, $T_A = -40\text{ }^\circ\text{C to }+105\text{ }^\circ\text{C}$)

Parameter	Symbol	Pin name	Value			Unit	Remarks
			Min	Typ	Max		
Resolution	—	—	—	—	10	bit	
Total error	—	—	- 3.0	—	+ 3.0	LSB	
Non-linear error	—	—	- 2.5	—	+ 2.5	LSB	
Differential linear error	—	—	- 1.9	—	+ 1.9	LSB	
Zero transition voltage	V_{OT}	AN0 to AN7	$AV_{SS} - 1.5\text{ LSB}$	$AV_{SS} + 0.5\text{ LSB}$	$AV_{SS} + 2.5\text{ LSB}$	V	1 LSB = ($AVRH - AV_{SS}$) / 1024
Full scale transition voltage	V_{FST}	AN0 to AN7	$AVRH - 3.5\text{ LSB}$	$AVRH - 1.5\text{ LSB}$	$AVRH + 0.5\text{ LSB}$	V	
Sampling time	t_{SMP}	—	0.4	—	16500	μs	4.5 V \leq $AV_{CC} \leq$ 5.5 V
			1.0				4.0 V \leq $AV_{CC} \leq$ 4.5 V
Compare time	t_{CMP}	—	0.66	—	—	μs	4.5 V \leq $AV_{CC} \leq$ 5.5 V
			2.2				4.0 V \leq $AV_{CC} \leq$ 4.5 V
A/D conversion time	t_{CNV}	—	1.44	—	—	μs	*1
Analog port input current	I_{AIN}	AN0 to AN7	- 0.3	—	+ 10	μA	
Analog input voltage	V_{AIN}	AN0 to AN7	0	—	$AVRH$	V	
Reference voltage	$AV+$	$AVRH$	$AV_{SS} + 2.7$	—	AV_{CC}	V	
Power supply current	I_A	AV_{CC}	—	2.3	6.0	mA	
	I_{AH}		—	—	5	μA	*2
Reference voltage supply current	I_R	$AVRH$	—	520	900	μA	$V_{AVRH} = 5.0\text{ V}$
	I_{RH}		—	—	5	μA	*2
Inter-channel variation	—	AN0 to AN7	—	—	4	LSB	

*1 : The time per channel (4.5 V \leq $AV_{CC} \leq$ 5.5 V, and internal operating frequency = 32 MHz) .

*2 : Defined as supply current (when $V_{CC} = AV_{CC} = AVRH = 5.0\text{ V}$) with A/D converter not operating, and CPU in stop mode.

- **Notes on the external impedance and sampling time of analog inputs**

A/D converter with sample and hold circuit. If the external impedance is too high to keep sufficient sampling time, the analog voltage charged to the internal sample and hold capacitor is insufficient, adversely affecting A/D conversion precision. Therefore, to satisfy the A/D conversion precision standard, consider the relationship between the external impedance and minimum sampling time and either adjust the register value and operating frequency or decrease the external impedance so that the sampling time is longer than the minimum value. If the sampling time is still not sufficient, connect a capacitor of about 0.1 μF to the analog input pin.

- Analog input equivalent circuit

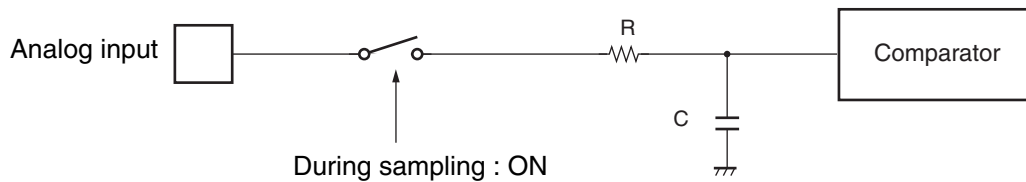

MB90F922NC/F922NCS/ F923NC/F923NCS/F924NC/F924NCS
MB90922NCS

	R	C
$4.5 \text{ V} \leq AV_{\text{cc}} \leq 5.5 \text{ V}$: 2.6 k Ω (Max)	8.5 pF (Max)
$4.0 \text{ V} \leq AV_{\text{cc}} \leq 4.5 \text{ V}$: 12.1 k Ω (Max)	8.5 pF (Max)

MB90V920-101/102

$4.5 \text{ V} \leq AV_{\text{cc}} \leq 5.5 \text{ V}$: 2.0 k Ω (Max)	14.4 pF (Max)
$4.0 \text{ V} \leq AV_{\text{cc}} \leq 4.5 \text{ V}$: 8.2 k Ω (Max)	14.4 pF (Max)

Note : The values are reference values.

MB90920 Series

- The relationship between the external impedance and minimum sampling time
- At $4.5\text{ V} \leq AV_{CC} \leq 5.5\text{ V}$

(External impedance = 0 kΩ to 100 kΩ)

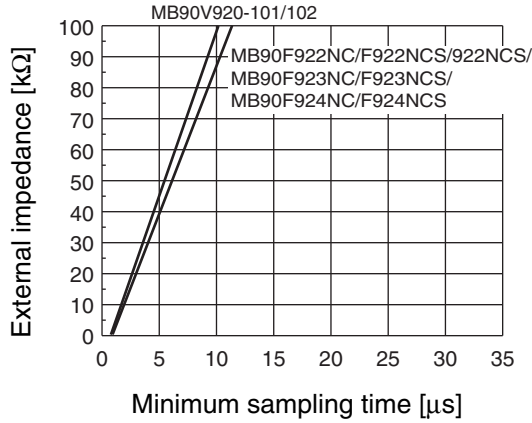

(External impedance = 0 kΩ to 20 kΩ)

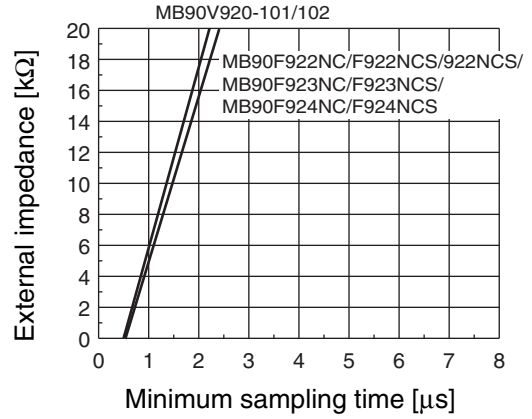

- At $4.0\text{ V} \leq AV_{CC} \leq 4.5\text{ V}$

(External impedance = 0 kΩ to 100 kΩ)



(External impedance = 0 kΩ to 20 kΩ)



- About errors
As $|AV_{RH} - AV_{SS}|$ becomes smaller, the relative errors grow larger.

(2) Definition of terms

- Resolution : Analog changes that are identifiable by the A/D converter.
- Non-Linear error : The deviation of the straight line connecting the zero transition point (“00 0000 0000” ↔ “00 0000 0001”) with the full-scale transition point (“11 1111 1110” ↔ “11 1111 1111”) from actual conversion characteristics.
- Differential linear error : The deviation from the ideal value of the input voltage needed to change the output code by 1 LSB.
- Total error : The total error is the difference between the actual value and the theoretical value, and includes zero-transition error/full-scale transition error and linear error.



$$\text{Total error for digital output } N = \frac{V_{NT} - \{1 \text{ LSB} \times (N - 1) + 0.5 \text{ LSB}\}}{1 \text{ LSB}} \quad [\text{LSB}]$$

$$1 \text{ LSB (Ideal)} = \frac{AVRH - AVSS}{1024} \quad [\text{V}]$$

N : A/D converter digital output value

$$V_{OT} \text{ (Ideal)} = AVSS + 0.5 \text{ LSB} \quad [\text{V}]$$

$$V_{FST} \text{ (Ideal)} = AVRH - 1.5 \text{ LSB} \quad [\text{V}]$$

V_{NT} : Voltage when the digital output changes from (N - 1) to N

(Continued)

(Continued)

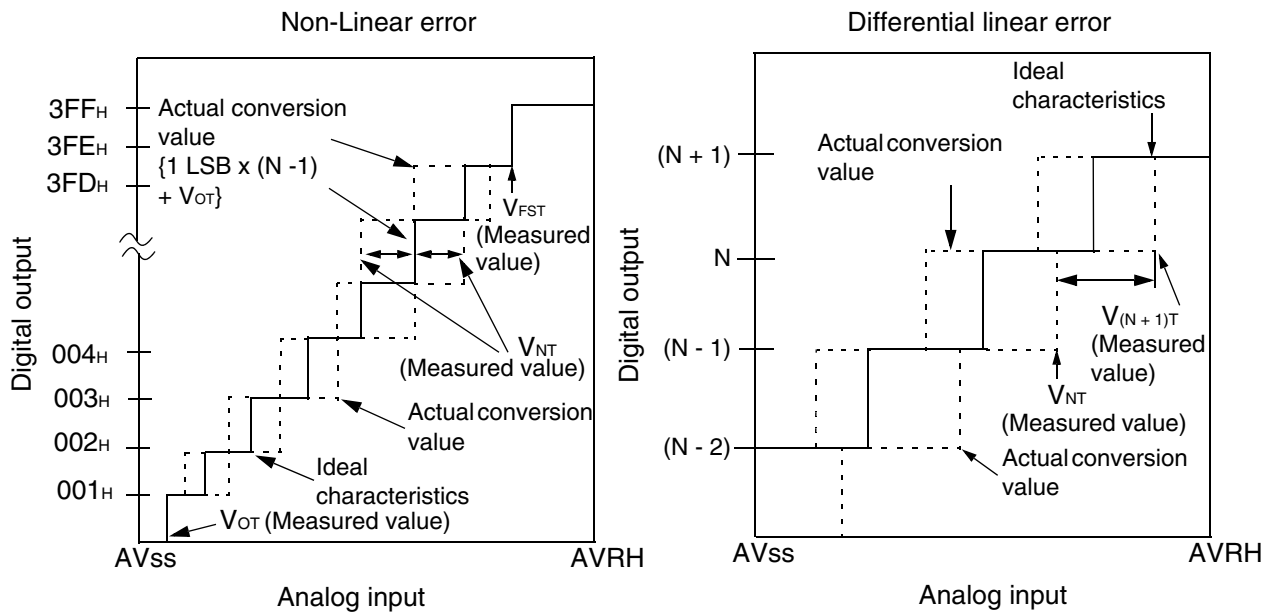

$$\text{Non-linear error of digital output } N = \frac{V_{NT} - \{1 \text{ LSB} \times (N - 1) + V_{OT}\}}{1 \text{ LSB}} \text{ [LSB]}$$

$$\text{Differential linear error of digital output } N = \frac{V_{(N+1)T} - V_{NT}}{1 \text{ LSB}} - 1 \text{ [LSB]}$$

$$1 \text{ LSB} = \frac{V_{FST} - V_{OT}}{1022} \text{ [V]}$$

N : A/D converter digital output value

V_{OT} : Voltage when digital output changes from 000_H to 001_H

V_{FST} : Voltage when digital output changes from 3FE_H to 3FF_H

6. Flash Memory Program/Erase Characteristics

Parameter	Conditions	Value			Unit	Remarks
		Min	Typ	Max		
Sector erase time	$T_A = +25\text{ }^\circ\text{C}$ $V_{CC} = 5.0\text{ V}$	—	0.9	3.6	s	Excludes pre-programming before erase
Word (16-bit width) programming time		—	23	370	μs	Excludes system-level overhead
Chip programming time	$T_A = +25\text{ }^\circ\text{C}$, $V_{CC} = 5.0\text{ V}$	—	3.4	55	s	
Erase/program cycle	—	10000	—	—	cycle	
Flash memory data retention time	Average $T_A = +85\text{ }^\circ\text{C}$	20	—	—	year	*

* : This value is calculated from the results of evaluating the reliability of the technology (using Arrhenius equation to translate high temperature measurements into normalized value at + 85 °C) .

MB90920 Series

■ ORDERING INFORMATION

Part number	Package	Remarks
MB90F922NCPMC MB90F922NCSPMC MB90922NCSPMC MB90F923NCPMC MB90F923NCSPMC MB90F924NCPMC MB90F924NCSPMC	120-pin plastic LQFP (FPT-120P-M21)	
MB90V920-101CR MB90V920-102CR	299-pin ceramic PGA (PGA-299C-A01)	For evaluation

PACKAGE DIMENSION

<p>120-pin plastic LQFP</p>  <p>(FPT-120P-M21)</p>	Lead pitch	0.50 mm
	Package width × package length	16.0 × 16.0 mm
	Lead shape	Gullwing
	Sealing method	Plastic mold
	Mounting height	1.70 mm MAX
	Weight	0.88 g
	Code (Reference)	P-LFQFP120-16×16-0.50



Please check the latest package dimension at the following URL.
<http://edevic.fujitsu.com/package/en-search/>

MB90920 Series

■ MAJOR CHANGES IN THIS EDITION

Page	Section	Change Results
12	■ I/O CIRCUIT TYPE	Corrected the circuit type B.
20	■ HANDLING DEVICES	Added the following items; <ul style="list-style-type: none">• Serial communication• Characteristic difference between flash device and MASK ROM device
31	■ I/O MAP	Corrected "Address: 003970H". Clock supervisor control register → (Disabled)
46	■ ELECTRICAL CHARACTERISTICS 3. DC Characteristics	Added the item for "LCD output impedance".
68	■ ORDERING INFORMATION	Corrected the part numbers; MB90V920-101 → MB90V920-101CR MB90V920-102 → MB90V920-102CR

The vertical lines marked in the left side of the page show the changes.

MEMO

MB90920 Series

FUJITSU SEMICONDUCTOR LIMITED

Nomura Fudosan Shin-yokohama Bldg. 10-23, Shin-yokohama 2-Chome,
Kohoku-ku Yokohama Kanagawa 222-0033, Japan

Tel: +81-45-415-5858

<http://jp.fujitsu.com/fsl/en/>

For further information please contact:

North and South America

FUJITSU SEMICONDUCTOR AMERICA, INC.

1250 E. Arques Avenue, M/S 333

Sunnyvale, CA 94085-5401, U.S.A.

Tel: +1-408-737-5600 Fax: +1-408-737-5999

<http://us.fujitsu.com/micro/>

Asia Pacific

FUJITSU SEMICONDUCTOR ASIA PTE. LTD.

151 Lorong Chuan,

#05-08 New Tech Park 556741 Singapore

Tel : +65-6281-0770 Fax : +65-6281-0220

<http://www.fujitsu.com/sg/services/micro/semiconductor/>

Europe

FUJITSU SEMICONDUCTOR EUROPE GmbH

Pittlerstrasse 47, 63225 Langen, Germany

Tel: +49-6103-690-0 Fax: +49-6103-690-122

<http://emea.fujitsu.com/semiconductor/>

FUJITSU SEMICONDUCTOR SHANGHAI CO., LTD.

Rm. 3102, Bund Center, No.222 Yan An Road (E),

Shanghai 200002, China

Tel : +86-21-6146-3688 Fax : +86-21-6335-1605

<http://cn.fujitsu.com/fss/>

Korea

FUJITSU SEMICONDUCTOR KOREA LTD.

206 Kosmo Tower Building, 1002 Daechi-Dong,

Gangnam-Gu, Seoul 135-280, Republic of Korea

Tel: +82-2-3484-7100 Fax: +82-2-3484-7111

<http://kr.fujitsu.com/fmk/>

FUJITSU SEMICONDUCTOR PACIFIC ASIA LTD.

10/F., World Commerce Centre, 11 Canton Road,

Tsimshatsui, Kowloon, Hong Kong

Tel : +852-2377-0226 Fax : +852-2376-3269

<http://cn.fujitsu.com/fsp/>

Specifications are subject to change without notice. For further information please contact each office.

All Rights Reserved.

The contents of this document are subject to change without notice.

Customers are advised to consult with sales representatives before ordering.

The information, such as descriptions of function and application circuit examples, in this document are presented solely for the purpose of reference to show examples of operations and uses of FUJITSU SEMICONDUCTOR device; FUJITSU SEMICONDUCTOR does not warrant proper operation of the device with respect to use based on such information. When you develop equipment incorporating the device based on such information, you must assume any responsibility arising out of such use of the information.

FUJITSU SEMICONDUCTOR assumes no liability for any damages whatsoever arising out of the use of the information.

Any information in this document, including descriptions of function and schematic diagrams, shall not be construed as license of the use or exercise of any intellectual property right, such as patent right or copyright, or any other right of FUJITSU SEMICONDUCTOR or any third party or does FUJITSU SEMICONDUCTOR warrant non-infringement of any third-party's intellectual property right or other right by using such information. FUJITSU SEMICONDUCTOR assumes no liability for any infringement of the intellectual property rights or other rights of third parties which would result from the use of information contained herein.

The products described in this document are designed, developed and manufactured as contemplated for general use, including without limitation, ordinary industrial use, general office use, personal use, and household use, but are not designed, developed and manufactured as contemplated (1) for use accompanying fatal risks or dangers that, unless extremely high safety is secured, could have a serious effect to the public, and could lead directly to death, personal injury, severe physical damage or other loss (i.e., nuclear reaction control in nuclear facility, aircraft flight control, air traffic control, mass transport control, medical life support system, missile launch control in weapon system), or (2) for use requiring extremely high reliability (i.e., submersible repeater and artificial satellite).

Please note that FUJITSU SEMICONDUCTOR will not be liable against you and/or any third party for any claims or damages arising in connection with above-mentioned uses of the products.

Any semiconductor devices have an inherent chance of failure. You must protect against injury, damage or loss from such failures by incorporating safety design measures into your facility and equipment such as redundancy, fire protection, and prevention of over-current levels and other abnormal operating conditions.

Exportation/release of any products described in this document may require necessary procedures in accordance with the regulations of the Foreign Exchange and Foreign Trade Control Law of Japan and/or US export control laws.

The company names and brand names herein are the trademarks or registered trademarks of their respective owners.

Mouser Electronics

Authorized Distributor

Click to View Pricing, Inventory, Delivery & Lifecycle Information:

Cypress Semiconductor:

[MB90922NCSPMC-GS-266E1](#) [MB90922NCSPMC-GS-264E1](#) [MB90922NCSPMC-GS-234E1](#) [MB90922NCSPMC-GS-128E1](#) [MB90922NCSPMC-GS-231E1](#) [MB90922NCSPMC-GS-204E1](#) [MB90922NCSPMC-GS-147E1](#)
[MB90922NCSPMC-GS-192E1](#) [MB90922NCSPMC-GS-224E1](#) [MB90922NCSPMC-GS-249E1](#) [MB90922NCSPMC-GS-213E1](#) [MB90922NCSPMC-GS-137E1](#) [MB90922NCSPMC-GS-258E1](#) [MB90922NCSPMC-GS-159E1](#)
[MB90922NCSPMC-GS-114E1](#) [MB90922NCSPMC-GS-256E1](#) [MB90922NCSPMC-GS-171E1](#) [MB90922NCSPMC-GS-136E1](#) [MB90922NCSPMC-GS-161E1](#) [MB90922NCSPMC-GS-222E1](#) [MB90922NCSPMC-GS-259E1](#)
[MB90922NCSPMC-GS-187E1](#) [MB90922NCSPMC-GS-206E1](#) [MB90922NCSPMC-GS-132E1](#) [MB90922NCSPMC-GS-167E1](#) [MB90922NCSPMC-GS-207E1](#) [MB90922NCSPMC-GS-143E1](#) [MB90922NCSPMC-GS-154E1](#)
[MB90922NCSPMC-GS-208E1](#) [MB90922NCSPMC-GS-235E1](#) [MB90922NCSPMC-GS-135E1](#) [MB90922NCSPMC-GS-225E1](#) [MB90922NCSPMC-GS-257E1](#) [MB90922NCSPMC-GS-164E1](#) [MB90922NCSPMC-GS-214E1](#)
[MB90922NCSPMC-GS-178E1](#) [MB90922NCSPMC-GS-190E1](#) [MB90922NCSPMC-GS-160E1](#) [MB90922NCSPMC-GS-138E1](#) [MB90922NCSPMC-GS-262E1](#) [MB90922NCSPMC-GS-173E1](#) [MB90922NCSPMC-GS-201E1](#)
[MB90922NCSPMC-GS-184E1](#) [MB90922NCSPMC-GS-223E1](#) [MB90922NCSPMC-GS-248E1](#) [MB90922NCSPMC-GS-148E1](#) [MB90922NCSPMC-GS-134E1](#) [MB90922NCSPMC-GS-177E1](#) [MB90922NCSPMC-GS-183E1](#)
[MB90922NCSPMC-GS-181E1](#) [MB90922NCSPMC-GS-261E1](#) [MB90922NCSPMC-GS-211E1](#) [MB90922NCSPMC-GS-122E1](#) [MB90922NCSPMC-GS-180E1](#) [MB90922NCSPMC-GS-151E1](#) [MB90922NCSPMC-GS-115E1](#)
[MB90922NCSPMC-GS-238E1](#) [MB90922NCSPMC-GS-189E1](#) [MB90922NCSPMC-GS-233E1](#) [MB90922NCSPMC-GS-152E1](#) [MB90922NCSPMC-GS-199E1](#) [MB90922NCSPMC-GS-150E1](#) [MB90922NCSPMC-GS-125E1](#)
[MB90922NCSPMC-GS-252E1](#) [MB90922NCSPMC-GS-188E1](#) [MB90922NCSPMC-GS-144E1](#) [MB90922NCSPMC-GS-127E1](#) [MB90922NCSPMC-GS-162E1](#) [MB90922NCSPMC-GS-193E1](#) [MB90922NCSPMC-GS-246E1](#)
[MB90922NCSPMC-GS-230E1](#) [MB90922NCSPMC-GS-202E1](#) [MB90922NCSPMC-GS-244E1](#) [MB90922NCSPMC-GS-140E1](#) [MB90922NCSPMC-GS-176E1](#) [MB90922NCSPMC-GS-172E1](#) [MB90922NCSPMC-GS-209E1](#)
[MB90922NCSPMC-GS-221E1](#) [MB90922NCSPMC-GS-205E1](#) [MB90922NCSPMC-GS-163E1](#) [MB90922NCSPMC-GS-191E1](#) [MB90922NCSPMC-GS-218E1](#) [MB90922NCSPMC-GS-271E1](#) [MB90922NCSPMC-GS-166E1](#)
[MB90922NCSPMC-GS-240E1](#) [MB90922NCSPMC-GS-220E1](#) [MB90922NCSPMC-GS-139E1](#) [MB90922NCSPMC-GS-170E1](#) [MB90922NCSPMC-GS-157E1](#) [MB90922NCSPMC-GS-117E1](#) [MB90922NCSPMC-GS-129E1](#)
[MB90922NCSPMC-G-003E1](#) [MB90922NCSPMC-GS-212E1](#) [MB90922NCSPMC-GS-165E1](#) [MB90922NCSPMC-GS-126E1](#) [MB90922NCSPMC-GS-186E1](#) [MB90922NCSPMC-GS-153E1](#) [MB90922NCSPMC-GS-131E1](#)
[MB90922NCSPMC-GS-197E1](#) [MB90922NCSPMC-GS-263E1](#)



Компания «ЭлектроПласт» предлагает заключение долгосрочных отношений при поставках импортных электронных компонентов на взаимовыгодных условиях!

Наши преимущества:

- Оперативные поставки широкого спектра электронных компонентов отечественного и импортного производства напрямую от производителей и с крупнейших мировых складов;
- Поставка более 17-ти миллионов наименований электронных компонентов;
- Поставка сложных, дефицитных, либо снятых с производства позиций;
- Оперативные сроки поставки под заказ (от 5 рабочих дней);
- Экспресс доставка в любую точку России;
- Техническая поддержка проекта, помощь в подборе аналогов, поставка прототипов;
- Система менеджмента качества сертифицирована по Международному стандарту ISO 9001;
- Лицензия ФСБ на осуществление работ с использованием сведений, составляющих государственную тайну;
- Поставка специализированных компонентов (Xilinx, Altera, Analog Devices, Intersil, Interpoint, Microsemi, Aeroflex, Peregrine, Syfer, Eurofarad, Texas Instrument, Miteq, Cobham, E2V, MA-COM, Hittite, Mini-Circuits, General Dynamics и др.);

Помимо этого, одним из направлений компании «ЭлектроПласт» является направление «Источники питания». Мы предлагаем Вам помощь Конструкторского отдела:

- Подбор оптимального решения, техническое обоснование при выборе компонента;
- Подбор аналогов;
- Консультации по применению компонента;
- Поставка образцов и прототипов;
- Техническая поддержка проекта;
- Защита от снятия компонента с производства.



Как с нами связаться

Телефон: 8 (812) 309 58 32 (многоканальный)

Факс: 8 (812) 320-02-42

Электронная почта: org@eplast1.ru

Адрес: 198099, г. Санкт-Петербург, ул. Калинина, дом 2, корпус 4, литера А.