

**CW INDUSTRIES**

**TORQ-TITE™**

**IDC CONNECTOR SYSTEM**



**CW INDUSTRIES**



Completely American Made

Catalog C-2110-84  
Rev. A-01

## About CW

---

Our history dates from the earliest days of electronics.

The Wirt Company was founded in 1904 by Charles Wirt, an associate of Thomas Alva Edison. Wirt pioneered the development of wirewound potentiometers, fixed wirewound resistors, automotive spark suppressors and slide switches. At the same time, engineers at Continental Carbon, Inc., were creating basic processes for manufacturing carbon composition resistors, pyrolytic metal film resistors and carbon film resistors. Following their merger, Continental Carbon, Inc. and The Wirt Company became Continental-Wirt Electronics Corporation and more recently, CW Industries. As CW Industries, we have developed patented products and processes for several segments of the electronics industry. These products include slide, rocker and pushbutton switches; insulation displacement connectors; and a variety of custom products.

Our fully integrated manufacturing facilities permit us to control the conversion of raw materials to finished product. In addition to engineering each of our basic designs and patented features, we have the capabilities to mold, stamp and plate in-house virtually every component used in each of our products. We design and build our own molds and contact dies, as well as most of our assembly equipment. We even have an environmental testing laboratory qualified by Defense Electronics Supply Center and Underwriters Laboratories to perform in-plant testing.

These facilities, plus our experience in making millions of terminations over the past years, uniquely qualify us to provide you with fully tested Insulation Displacement Connectors with a significant improvement in design, reliability, delivery and overall cost.

Our technical staff and local value-added assembly centers are available to provide application engineering assistance. We can provide 100% tested, ready-to-use cable assemblies made to your specifications... or connectors, cable and assembly tools for your in-house assembly.

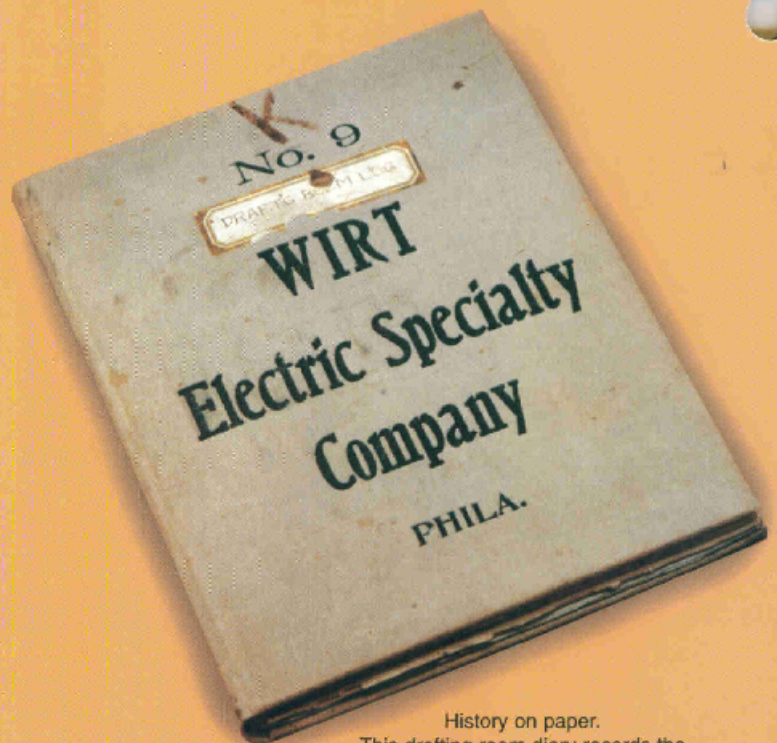

History on paper.  
This drafting room diary records the engineering department activities of the Wirt Company in the year 1912.



## About CW Insulation Displacement Connectors

---

CW mass terminated Insulation Displacement Connectors are specifically designed to provide a highly reliable long term, gas-tight connection at every position. In addition to our patented Torq-Tite™ contact, other significant design advantages include ruggedness of construction, ease of assembly, integral strain relief options, choice of contact materials and plating finishes. The complete series of DIP, PCB, Socket and Header, Card Edge and D-Subminiature Connectors meets applicable Military Specifications, and offers direct interchangeability with other industry standard Insulation Displacement Connectors.

CW connectors are designed not only for reliability, but also for ease of use in many applications. Simple assembly tools can be used to terminate CW connectors to cable, since preassembled covers and built-in guides on each connector orient cable conductors to contact tines. Cover types for strain relief,

daisy-chaining, or cable end protection are available. Light or heavy gold over nickel plated contacts or tin-lead plated contacts are available to suit specific applications.

All elements of the CW connector system are available through a nation-wide network of stocking distributors and value-added assembly centers. They have on hand a comprehensive inventory of all types of flat cable and connectors for fast delivery of connectors or 100% pre-tested, ready to use assemblies made to your specifications.

The connectors in this catalog are covered by one or more of United States patents 3,993,393 and 4,348,073 and 3,858,159 and 3,850,840 and by pending U.S. patent applications. Corresponding foreign patents and pending applications also apply.

## Table of Contents

---

|  |                    |  |
|--|--------------------|--|
| About CW   | Inside front cover |  |
| About CW Insulation Displacement Connectors                      | Page 1             |  |
| Selection Criteria for IDC's                                     | Pages 2, 3         |  |
| Selection Guide, Connectors and Cable                            | Pages 4, 5         |  |
| Socket   |                    |  |
| Design Features  | Pages 6, 7         |  |
| Specifications and Dimensions                                    | Pages 8, 9         |  |
| Header   |                    |  |
| Design Features  | Pages 10, 11       |  |
| Specifications and Dimensions                                    | Pages 12, 13       |  |
| Fully Shrouded Header  | Pages 14, 15       |  |
| Low Profile Box Header   | Pages 16, 17       |  |
| D-Subminiature   |                    |  |
| All Plastic "D" Design Features                                  | Pages 18, 19       |  |
| All Plastic "D" Specifications and Dimensions                    | Pages 20, 21       |  |
| Metal Faced "D" and EMI/RFI Shield Design Features               | Pages 22, 23       |  |
| Metal Faced "D" and EMI/RFI Shield Specifications and Dimensions | Pages 24, 25       |  |
| Card Edge  |                    |  |
| Design Features  | Pages 26, 27       |  |
| Specifications and Dimensions                                    | Pages 28, 29       |  |
| DIP  |                    |  |
| Design Features  | Pages 30, 31       |  |
| Specifications and Dimensions                                    | Pages 32, 33       |  |
| PCB  |                    |  |
| Design Features  | Pages 34, 35       |  |
| Specifications and Dimensions                                    | Pages 36, 37       |  |
| Flat Cable   |                    |  |
| Extruded Gray  | Page 38            |  |
| Color-Coded Cable  | Page 39            |  |
| Assembly Tools   | Page 40            |  |
| Significance of Mil-DTL-83503 and Mil-DTL-24308 Approvals        | Page 41            |  |
| Part Number Index  | Page 42            |  |
| Notes  | Page 43, 44        |  |
| Other CW Industries Products                                     | Inside back cover  |  |

# Selection Criteria for IDCs

Selection decisions on Insulation Displacement Connectors (IDCs) present opportunities for significant improvements in quality, interchangeability, and cost-effective handling and assembly. The connectors selected will impact significantly on the overall reliability and usefulness of the final system. Here are the important considerations in the selection of IDC components:

## The Electrical Contacts

Contact integrity must be maintained in two places—between the contact and the cable conductor and between the contact and its mate...whether it be a PC board, a pin or a socket. There can be no compromise on either end.

A properly designed contact will completely displace the insulation, and provide clean metal-to-metal contact with the conductor, insuring a long-term, gas-tight connection.

One end of our patented IDC contact consists of a pair of offset tines. When forced through the

insulation, they slide along the conductor, compressing it and gripping it to form a gas-tight connection. The conductor is compressed by dual force. As the cable conductor is wedged into the contact's insulation displacement slot, the wiping action of the tines cleans the conductor surface and the conductor is compressed. In addition to the compression force, a second force is created by the offset tines. The resultant torque produces a long-term, Torq-Tite™ connection, impervious to

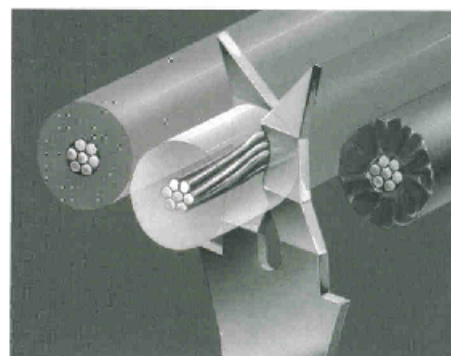

environmental contaminants.

The electrical connection on the other end—between the contact and its mate—whether it be a PC board, a pin or a socket, is of equal importance. Here structural design, materials, area of contact, surface finish, contact redundancy, and mechanical means of seating the contact in the insulator can be critical. Every CW contact has been designed with full consideration of each of these factors.

## The Insulator

The excellent electrical insulating characteristics of IDCs, their physical ruggedness, ability to withstand extremes of environmental conditions, and ease of assembly are the result of careful and detailed material testing and selection as well as insulator design. Where the connector is exposed to soldering, the insulator must be resistant to dissolution by solder, fluxes and PC

board washes. The material should be rugged enough to be handled without breaking or chipping and strong enough to hold the contacts firmly in place. It should be chemically-inert and have dielectric properties consistent with the application requirements. These are the criteria considered in selecting materials for all CW insulators.

## Mating and Interchangeability

An important consideration in the design and development of every CW connector is compatibility and mateability with connectors of other manufacturers.

The problem of connecting a PCB, DIP or Card Edge connector to a printed circuit board are not as serious as mating a "socket" to a "header" or a "socket" D-Subminiature to a "pin" D-Subminiature, when connectors from different manufacturers are used. CW connector designs, in almost every instance, minimize electrical or

mechanical mismatches resulting from mating connectors of various manufacturers. Our designs permit dual sourcing of almost all elements. To this end, CW has worked closely with the US Defense Electronic Supply Center in the development of industry standards and specifications as defined in Mil-DTL-83503. CW IDC connector products are qualified to applicable Mil-DTL-83503 standards and are interchangeable and mateable with other connectors so qualified.

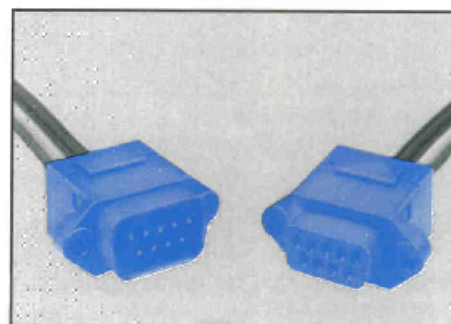
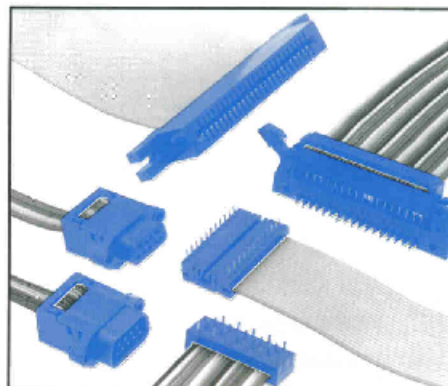

## Polarization and Contact Identification

Where there are so many electrical circuit connection possibilities, contact identification is desirable. CW includes numbered contacts on most connectors.

An inherent part of the CW system is a positive means of polarizing mating pairs of IDCs, or positively

orienting the connector to the PC board, thereby preventing cross wiring and possible equipment damage.

Standardization is attained by using polarization and identification methods consistent with Mil-DTL-83503 specifications.

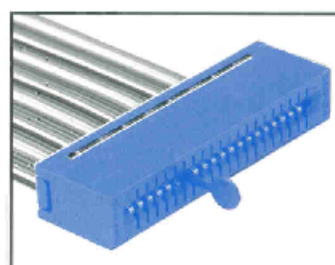
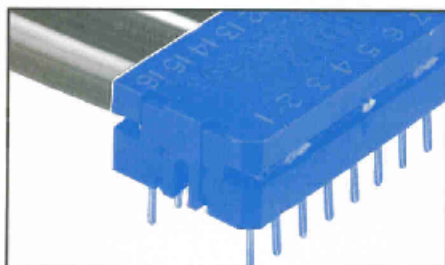

## Strain Relief

Test the strength of your cable and connector by pull a test. In Torq-Tite™ D-Subminiature and Card Edge Connectors, strain reliefs are "built-in." In DIPs, PCBs and Sockets, you may require an optional strain relief for additional protection. CW's strain relief designs effectively isolate the connection of cable-to-contact from mechanical strain even if the cable is pulled or yanked. CW strain reliefs require limited space, are easy to apply, are available in several options for alternate cable orientation, and are

capable of withstanding a minimum pull-off force of 8 ounces per contact, consistent with Mil-DTL-83503 standards.

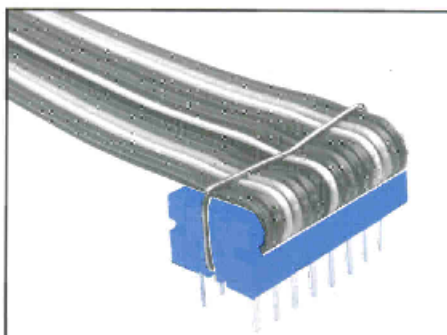

## Reusable Cover

The ability to remove the connector cover without breakage is often desirable. Most CW designs make it possible to easily, safely and non-destructively remove the cover that protects the connection. The connector, and often the cover itself, are *reusable*.

## Ease of Assembly



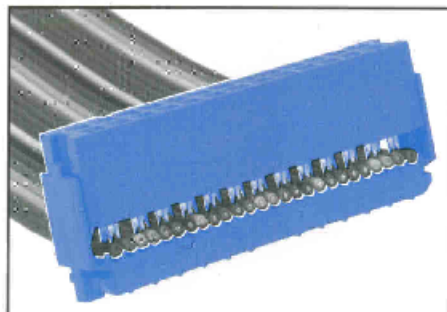

Assembly is often performed by unskilled personnel seeking to achieve more speed than precision. Therefore, the key element of cable alignment should not depend on a high degree of operator skill. CW's simple assembly method reduces time and cost, and produces reliable connectors with contacts firmly and precisely seated in the connector bases. Factory preassembled covers and built-in cable guides are featured on most connectors. Complex assembly tools are not

required. With CW's assembly press, a simple lower die holds the connector in place while a parallel force applied to the cover terminates

each IDC contact to the corresponding conductor in the flat cable and locks the cover in place.

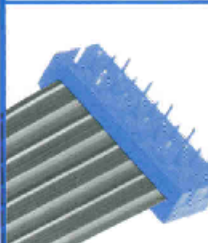

# CW Insulation Displacement Connectors:

|  | Description  | Features  |
|--|--|---|
|    | <p><b>Socket</b><br/>Normally used to interconnect PC boards or points on a backplane through headers or pins on .100 in. x .100 in. spacing.<br/>Advanced design includes patented Torq-Tite™ contact for positive gas-tight cable termination. Nose end of contact provides superior wiping action and redundant electrical contact.<br/>Qualified per U.S. Defense Department to Mil-DTL-83503/7 and interchangeable and mateable with other connectors so qualified.</p> | <ul style="list-style-type: none"> <li>• Mil-DTL-83503/7 approved</li> <li>• Preassembled cover provides for precise, rapid assembly</li> <li>• Ridges on cover help align cable</li> <li>• Reusable contact and cover design</li> <li>• Choice of polarizing method and optional strain relief strap</li> </ul>  |
|    | <p><b>Headers</b><br/>Fully shrouded, 3 wall and low profile box headers are available to provide a reliable mating interface for standard sockets having .100 in. x .100 in. contact spacing.<br/>Headers have pins on their mating side and offer the designer a choice of either wire-wrap or solder pins in various lengths on the opposing end in straight or right angle styles.<br/>Qualified per U.S. Defense Department to Mil-DTL-83503/20, 21, 24 and 25.</p>     | <ul style="list-style-type: none"> <li>• Mil-DTL-83503/20, 21, 24 and 25 approved</li> <li>• Mateable with sockets from other manufacturers, with or without strain relief</li> <li>• Patented polarization design consistent with Mil-DTL-83503 standards—integral ribs eliminate need for gluing polarizing keys to the header base</li> <li>• Polarization ribs can be removed for use with non-polarized sockets</li> <li>• Easy ejection, and secure locking available with long or short latches</li> </ul> |
|   | <p><b>D-Subminiature</b><br/>Ideal for input/output applications and interconnecting electronic equipment. Connectors are UL recognized and CSA listed and are designed to meet the applicable standards of Mil-DTL-24308. They are interchangeable and mateable with other connectors that meet these standards.<br/>Available in all-plastic or metal-face versions with optional EMI/RFI shield.</p>  | <ul style="list-style-type: none"> <li>• Choice of 3-way strain relief</li> <li>• Accepts standard .050 in. conductor spacing cable without special cable preparation</li> <li>• Preassembled cover provides for precise, rapid assembly</li> <li>• Accepts jacketed and shielded cable without the need for a backshell</li> <li>• Patented contact design provides for precise mating with our D-Subminiature connectors</li> <li>• Metal Face and shield provide EMI/RFI shielding</li> </ul>                  |
|  | <p><b>Card Edge</b><br/>Provides a fast means for connecting/disconnecting single, double-sided or multi-layer PC boards.<br/>Extra long cantilevered contact provides an extended self-cleaning, wiping action, and ensures positive connection to the board.<br/>Good contact pressure is maintained with minimal wear on PC board pads.</p>   | <ul style="list-style-type: none"> <li>• Factory pre-assembled cover provides for fast assembly</li> <li>• Self-adjusting contact force adjusts for variations in PC board thickness</li> <li>• Long cantilever contact provides consistent insertion/withdrawal forces</li> <li>• Full polarization capability</li> <li>• Reusable contact and cover design</li> </ul>   |
|  | <p><b>DIP</b><br/>Used for rapid, permanent connection of ribbon cable to a PC board or when connect/disconnect capabilities are required.<br/>Mates with a standard DIP socket.<br/>Cover is factory preassembled to connector base to simplify handling and assembly of cable.<br/>Qualified per U.S. Defense Department to Mil-DTL-83503/6.</p>   | <ul style="list-style-type: none"> <li>• Mil-DTL-83503/6 approved</li> <li>• Sturdy, yet flexible terminal posts</li> <li>• No "bare shoulders" on the contact at the PC board interface</li> <li>• Preassembled cover minimizes assembly time</li> <li>• Optional strain relief strap is available</li> </ul>  |
|  | <p><b>PCB</b><br/>Used when a permanent connection of flat cable to the PC board is required. Cable is terminated to the PCB plug to make a reliable gas-tight connection through use of Torq-Tite™ contacts. The connector's pins are then soldered to the board.<br/>Qualified per U.S. Defense Department to Mil-DTL-83503/23.</p>  | <ul style="list-style-type: none"> <li>• Mil-DTL-83503/23 approved</li> <li>• Sturdy, yet flexible solder posts able to withstand bending and straightening</li> <li>• No "bare shoulders" on the contact at the PC board interface</li> <li>• Integral strain-relief option available</li> <li>• Cover lip available for cable end termination</li> </ul>  |

# Selection Guide to **CW** Flat Cable

| No. of Conductors                                  | Pages                                | Standards and Specifications   |
|--|--------------------------------------|--|
| 10, 14, 16, 20,<br>26, 34, 40,<br>50, 60           | 6, 7<br>8, 9                         | <ul style="list-style-type: none"> <li>• Contacts: phosphor bronze, standard.</li> <li>• Contact Plating:<br/>30 <math>\mu</math> in. gold over<br/>50 <math>\mu</math> in. nickel, standard*<br/>10 <math>\mu</math> in. gold over<br/>50 <math>\mu</math> in. nickel optional*<br/>50 <math>\mu</math> in. gold over<br/>50 <math>\mu</math> in. nickel, optional<br/>100 <math>\mu</math> in. tin-lead optional*<br/>200 <math>\mu</math> in. tin-lead optional*</li> <li>• Housing Material<br/>UL 94V-0 flame-retardant thermoplastic</li> <li>• Color: blue</li> <li>• Operating Temperature:<br/>-55° to +125°C</li> <li>• Current Rating: 1 amp (maximum) per contact</li> <li>• Dielectric Withstand Voltage: greater than 500 Vdc at sea level</li> <li>• Insulation Resistance: greater than <math>5 \times 10^9</math> ohms</li> <li>• Standard Contact Resistance<br/>15 milliohms max.</li> <li>* Tin-lead plating not available on header connectors.<br/>10 <math>\mu</math> in. gold over 50 <math>\mu</math> in. nickel is standard contact plating on DIP connectors.<br/>100 <math>\mu</math> in. tin-lead is standard contact plating on PCB connectors.</li> </ul> |
| 10, 14, 16, 20,<br>26, 34, 40,<br>50, 60           | 10, 11<br>12, 13<br>14, 15<br>16, 17 |  |
| 9, 15,<br>25, 37 with<br>pin or socket<br>contacts | 18, 19<br>20, 21<br>22, 23<br>24, 25 |  |
| 10, 20, 26,<br>34, 40, 50                          | 26, 27<br>28, 29                     |  |
| 14, 16<br>24, 40                                   | 30, 31<br>32, 33                     |  |
| 10, 20, 26,<br>34, 40, 50,<br>60                   | 34, 35<br>36, 37                     |  |

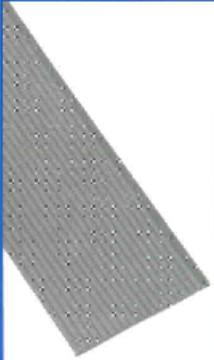
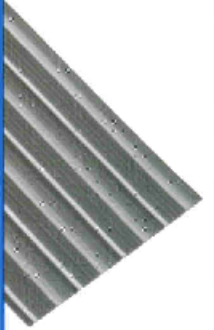
|   | Flat Cable Guide  | Page |
|---|---|------|
|   | <p><b>Gray</b><br/>28 AWG (7/36) .050 in. conductor spacing<br/>No. Conductors:<br/>9, 10, 14, 15, 16, 20, 24, 25, 26, 34, 37, 40, 50, 60</p> <ul style="list-style-type: none"> <li>• Extruded, mirror image design</li> <li>• UL Style 2651</li> </ul>            | 38   |
|  | <p><b>Color-coded</b><br/>28 AWG (7/36) .050 in. conductor spacing<br/>No. Conductors:<br/>9, 10, 14, 15, 16, 20, 24, 25, 26, 34, 37, 40, 50, 60</p> <ul style="list-style-type: none"> <li>• Bonded</li> <li>• Thinner Bonded Cable—only .035 in. thick</li> </ul> | 39   |

# Socket Connectors

Socket connectors are typically used to interconnect PC boards or points on a backplane through headers or pins on .100 in. x .100 in. spacing.

They feature an advanced mechanical design which includes CW's patented offset-tine (Torq-Tite™) contact for positive gas-tight cable termination. The nose end of the contact provides a long, dual cantilever for a longer wiping action and improved self-cleaning of the mating pin. The extra length also results in a longer and more reliable working life.

The preassembled cover design allows fast, reliable assembly to extruded, bonded or laminated cable and features built-in cable alignment. These features permit the use of simplified termination equipment.

CW's socket connectors meet Mil-DTL-83503/7 specifications and are listed on the U.S. Defense Department's Qualified Products List.

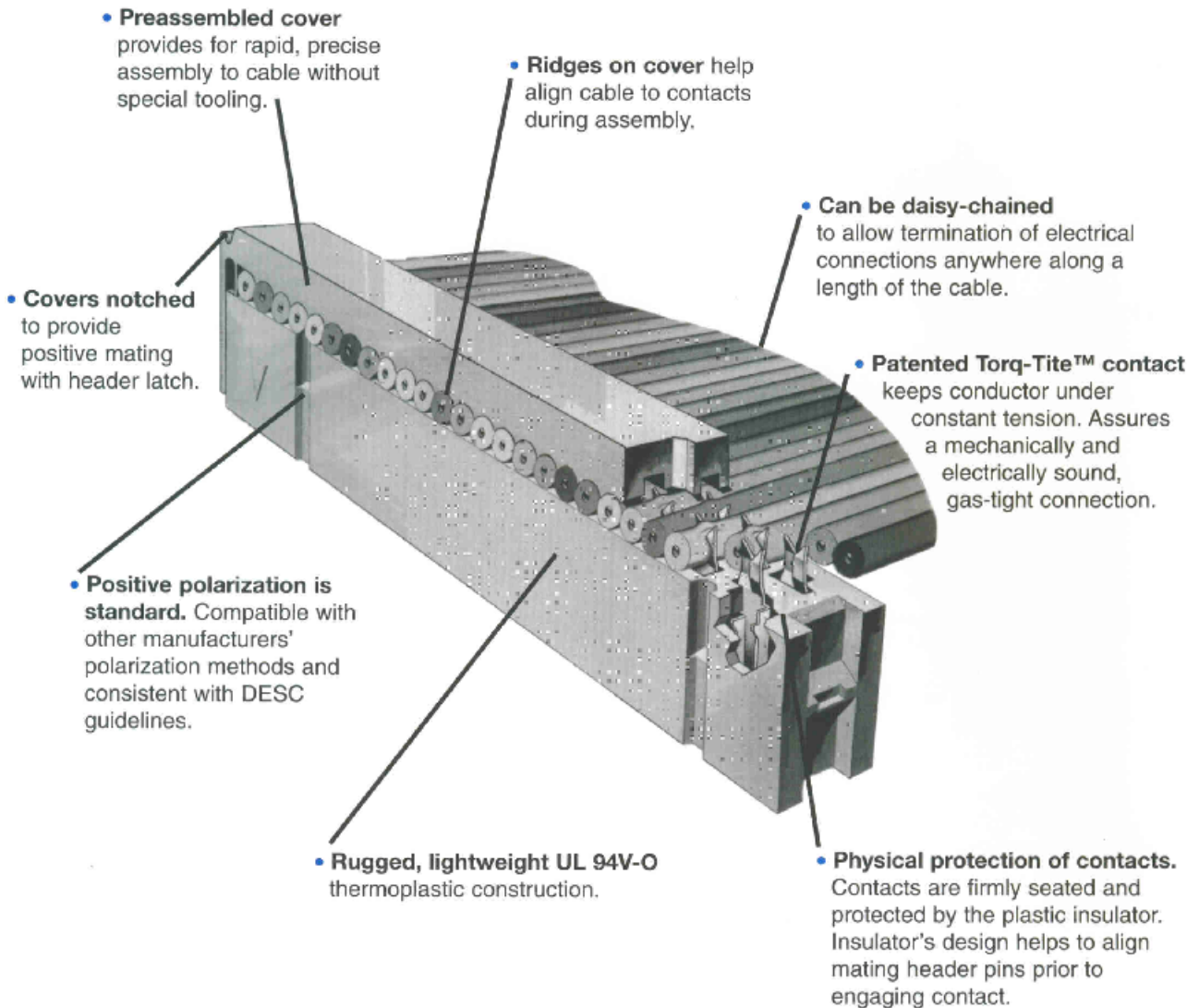



## Contact

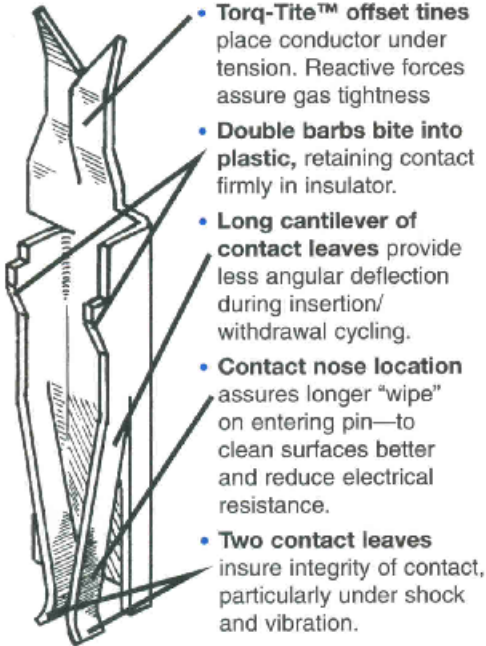

- **Torq-Tite™ offset tines** place conductor under tension. Reactive forces assure gas tightness
- **Double barbs bite into plastic**, retaining contact firmly in insulator.
- **Long cantilever of contact leaves** provide less angular deflection during insertion/withdrawal cycling.
- **Contact nose location** assures longer "wipe" on entering pin—to clean surfaces better and reduce electrical resistance.
- **Two contact leaves** insure integrity of contact, particularly under shock and vibration.

## Socket Connector Features

- 10, 14, 16, 20, 26, 34, 40, 50, 60 contact versions.
- 30  $\mu$  in. gold (in mating area) over 50  $\mu$  in. nickel-plated phosphor bronze contacts standard: optional gold plating thicknesses or tin-lead plating also available.
- **Fully interchangeable with competitive sockets and headers.** Meets Mil-DTL-83503 specifications; mateable with standard headers having contacts on .100 in. centers.
- **Insulated metal strain relief cover.** Protects contacts from excessive strain on cable.
- **Optional polarizing key** available.
- **Molded covers can be readily removed** and connectors reused.
- Mil-DTL-83503 approved.

## Socket Contact

All CW socket connectors incorporate our patented Torq-Tite™ contact for positive, gas-tight cable terminations. An extra long, dual-cantilevered contact on the mating end assures a reliable connection even under vibration. The contact's mating area is located near the face of the connector to provide a longer, self cleaning wipe on the corresponding header pins.

## Strain Relief

With the CWR-210 series sockets, an insulated, metal strain relief strap provides increased protection from forces applied to the cable, consistent with the requirements of Mil-DTL-83503. The connector is designed with a recess in the molded cover to allow the bend in the cable to fall within the connector's profile. This feature permits closer connector spacing than is possible with socket connectors from other manufacturers.

## Polarization

Choose your polarization method from one of three options:

**Method I:** Grooves in sockets CWR-210 and 220 match up with ribs on mating headers. (Mil-DTL-83503 approved method.)

**Method II:** Plastic key (**CWN-Key-1**) inserted into socket contact prevents mismating if corresponding header contact is removed.

**Method III:** In addition to mating socket grooves and header slots, central polarizing key on one socket side (CWR-217 and CWR-227) mates with matching central header slot.

## Assembly

A factory preassembled cover eliminates the need for complicated assembly tooling. The connector cover aligns the cable to the contacts. The individual conductors are terminated by applying opposing parallel forces on the connector cover and base.

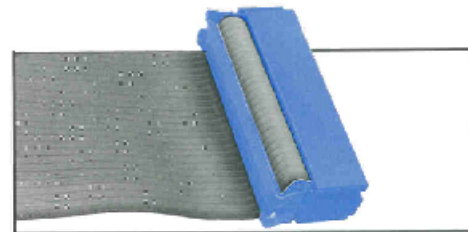

Method I

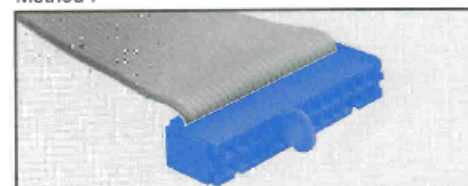

Method II

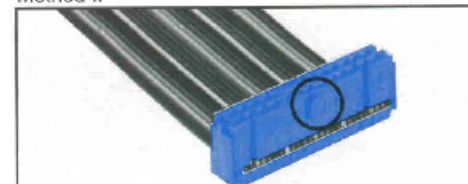

Method III

## Engineering Dimensions

### Dimensions

Socket Connector  
with Metal Strain Relief Strap

| CONNECTOR DIMENSIONS |                  |                  |                  |                  |
|----------------------|------------------|------------------|------------------|------------------|
| NO. CONTS.           | A                | B                | C                | D                |
| 10                   | .400<br>(10.16)  | .515<br>(13.08)  | .677<br>(17.20)  | .690<br>(17.53)  |
| 14                   | .600<br>(15.24)  | .715<br>(18.16)  | .877<br>(22.28)  | .890<br>(22.61)  |
| 16                   | .700<br>(17.78)  | .815<br>(20.70)  | .977<br>(24.82)  | .990<br>(25.15)  |
| 20                   | .900<br>(22.86)  | 1.015<br>(25.78) | 1.177<br>(29.90) | 1.190<br>(30.23) |
| 26                   | 1.200<br>(30.48) | 1.315<br>(33.40) | 1.477<br>(37.52) | 1.490<br>(37.85) |
| 34                   | 1.600<br>(40.64) | 1.715<br>(43.56) | 1.877<br>(47.68) | 1.890<br>(48.01) |
| 40                   | 1.900<br>(48.26) | 2.015<br>(51.18) | 2.177<br>(55.30) | 2.190<br>(55.63) |
| 50                   | 2.400<br>(60.96) | 2.515<br>(63.88) | 2.677<br>(68.00) | 2.690<br>(68.33) |
| 60                   | 2.900<br>(73.66) | 3.015<br>(76.58) | 3.177<br>(80.70) | 3.190<br>(81.03) |

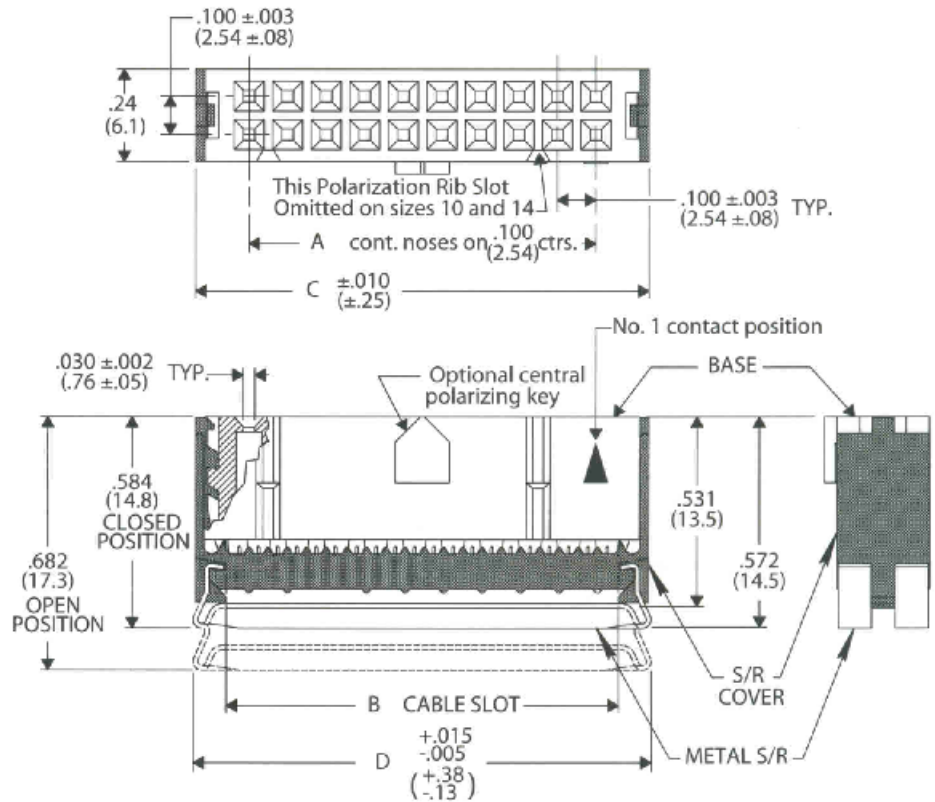

Socket Connector  
with Non-Strain Relief Cover

| CONNECTOR DIMENSIONS |                  |                  |                  |
|----------------------|------------------|------------------|------------------|
| NO. CONTS.           | A                | B                | C                |
| 10                   | .400<br>(10.16)  | .515<br>(13.08)  | .677<br>(17.20)  |
| 14                   | .600<br>(15.24)  | .715<br>(18.16)  | .877<br>(22.28)  |
| 16                   | .700<br>(17.78)  | .815<br>(20.70)  | .977<br>(24.82)  |
| 20                   | .900<br>(22.86)  | 1.015<br>(25.78) | 1.177<br>(29.90) |
| 26                   | 1.200<br>(30.48) | 1.315<br>(33.40) | 1.477<br>(37.52) |
| 34                   | 1.600<br>(40.64) | 1.715<br>(43.56) | 1.877<br>(47.68) |
| 40                   | 1.900<br>(48.26) | 2.015<br>(51.18) | 2.177<br>(55.30) |
| 50                   | 2.400<br>(60.96) | 2.515<br>(63.88) | 2.677<br>(68.00) |
| 60                   | 2.900<br>(73.66) | 3.015<br>(76.58) | 3.177<br>(80.70) |

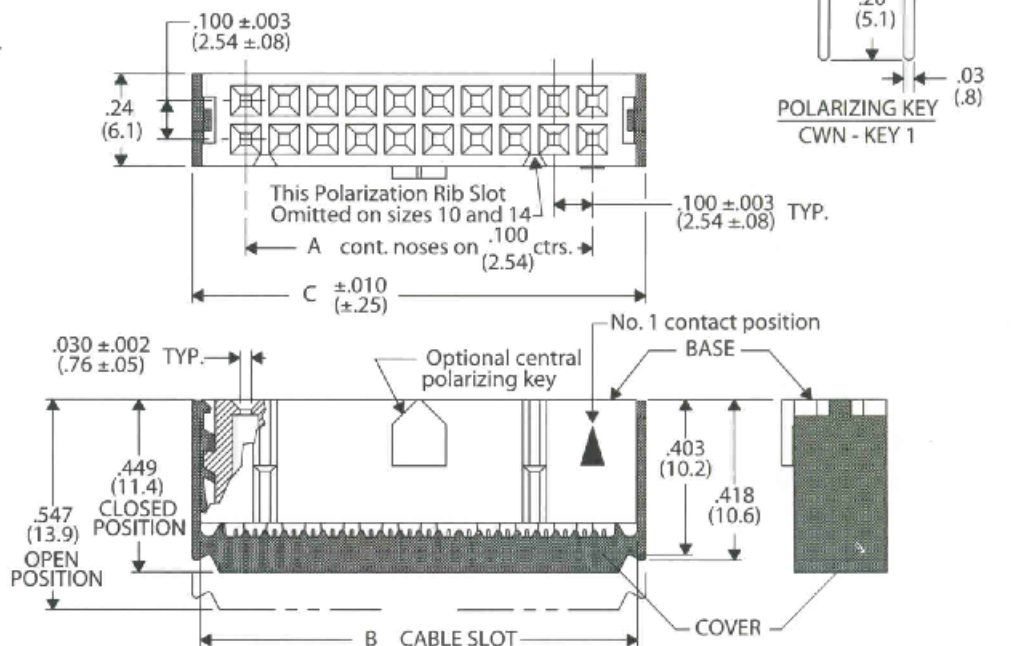

# Specifications and Ordering Information

## Specifications

- Contacts: phosphor bronze, standard.
- Contact Plating: 30µ in. gold (in mating area) over 50µ in. nickel, standard; 10µ in. gold (in mating area) over 50µ in. nickel, optional; 50µ in. gold (in mating area) over 50µ in. nickel, optional; 100µ in. 60/40 tin-lead optional.
- Insulator Material: UL 94V-O flame-retardant thermoplastic
- Strain Relief Strap Material: insulated stainless steel
- Color: blue
- Operating Temperature: -55°C to +125°C
- Current Rating: 1A (maximum) per contact
- Dielectric Withstand Voltage: greater than 500 Vdc at sea level
- Insulation Resistance: greater than 5x10<sup>9</sup> ohms
- Withdrawal force 2-8 oz/contact, typical
- Cover pull-off force 8 oz/contact minimum (force along contacts' primary axes)

## How to Order Socket Connectors

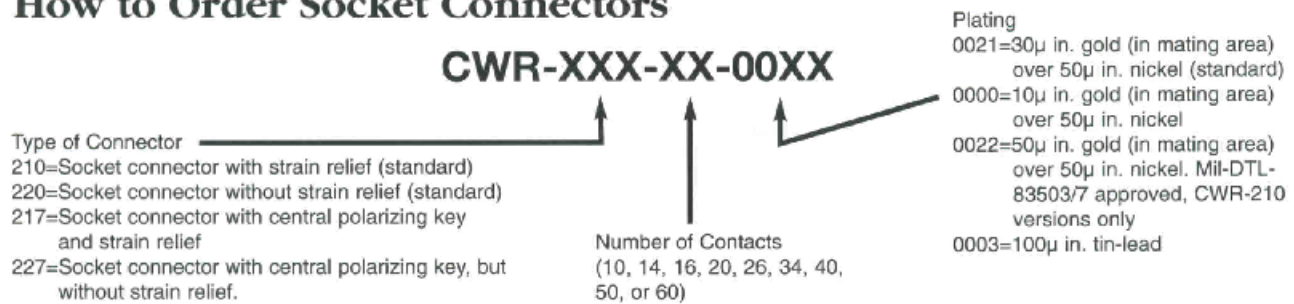

## How to Order Socket Cable Assemblies

Cable assemblies with two socket connectors on a prescribed length of gray flat cable are available with the connectors oriented per drawings 9-1 or 9-2. (#1 contacts oriented on red conductor.) For other lengths, orientations, numbers or combinations of connectors, contact the factory or your local value-added distributor.

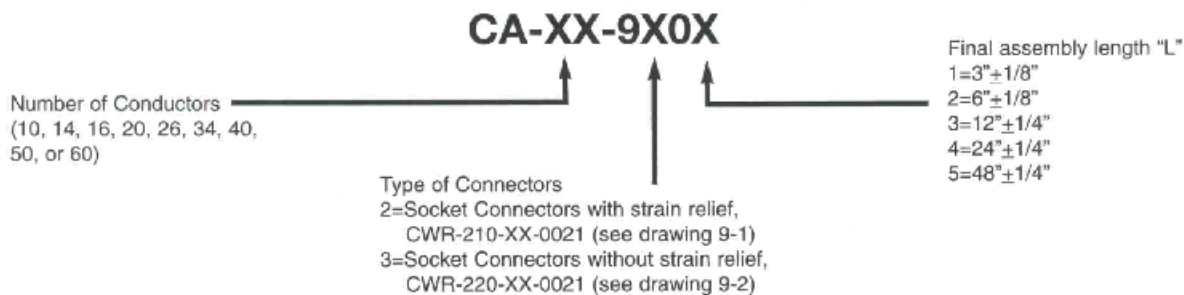
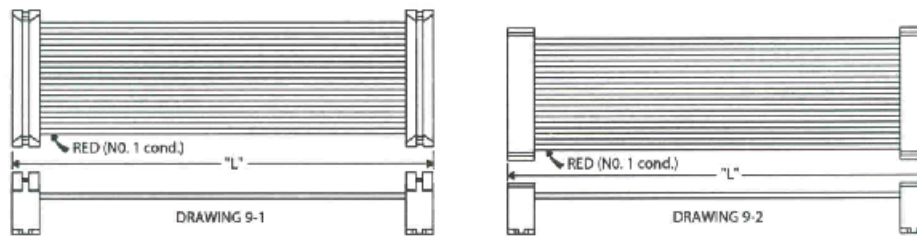

# Header Connectors

Header connectors are often permanently mounted to PC boards and mate with female socket connectors having a .100 in. (2.54mm) x .100 in. (2.54mm) contact spacing.

The headers have male pins on their mating side and offer the designer a choice of either wire-wrap or solder posts in various lengths on the opposing end.

With CW, the designer also can choose either straight or right-angle contacts and allow sockets to mate with headers at right angles or parallel to mating PC board or wire-wrap plane. Optional ejection latches in various sizes are available, to mate with strain relief or non-strain relief sockets.

Polarization ribs are securely molded into place, eliminating the need for gluing polarizing keys to the header base. These ribs are easily removed for applications requiring a non-polarized interconnection.

CW headers are Mil-DTL-83503/20, 21, 24 and 25 approved.

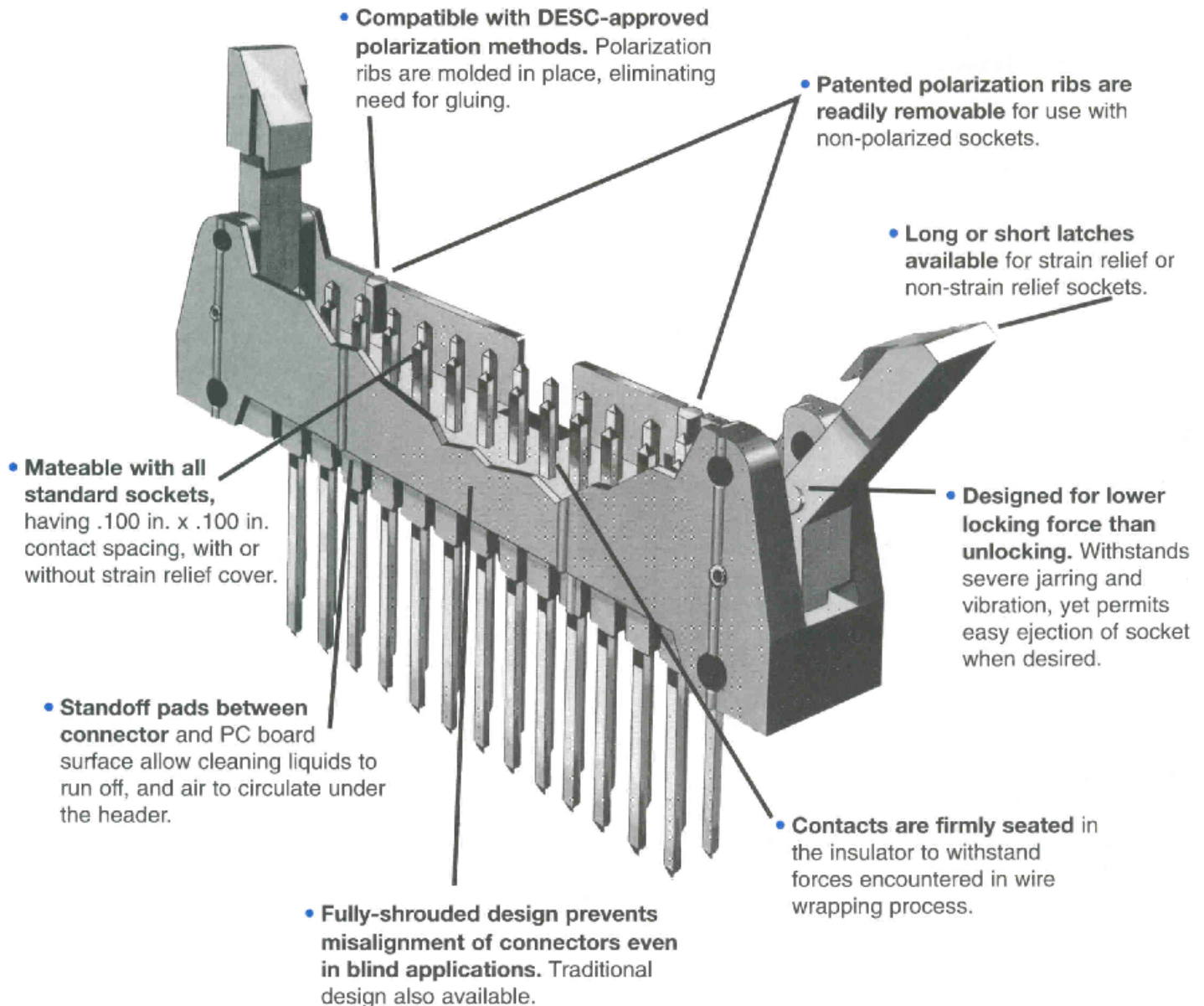

## Contact

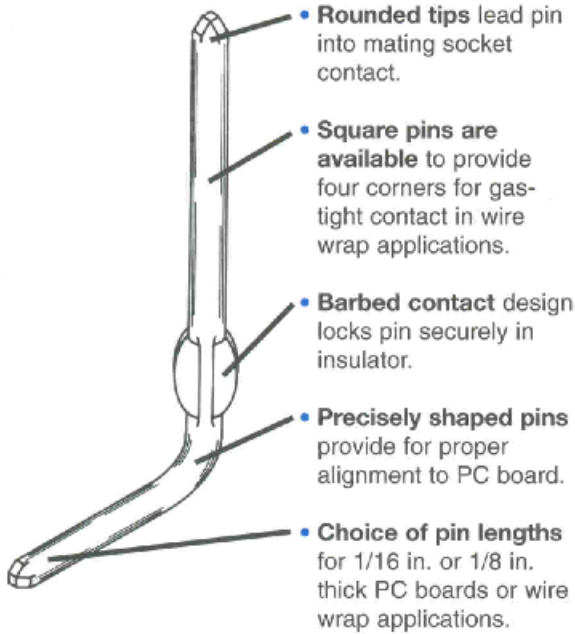

## Header Connector Features

- 10,14, 16, 20, 26, 34, 40, 50, 60 pin versions
- Available with right angle or straight solder tails for 1/16 in. or 1/8 in. thick PC boards
- Available with right angle or straight wire wrap terminals
- Gold-plated, phosphor bronze contacts standard
- Rugged, lightweight UL 94V-0 thermoplastic construction

## Ejection Latches

Ejection latches are available for all CW Header connectors. These latches assure secure locking of the Socket to the Header, as well as simple, trouble-free detachment of the mated Socket from the Header. An audible click indicates that Header and Socket are fully mated. The latching surfaces are consistent with DESC requirements for interchangeability.

Two latch sizes are featured—short for non-strain relief sockets and long for strain relief sockets. For others, contact factory. Each latch is held securely in place with a roll pin and can be removed at a work bench or in the field.



## Polarization

Choose your polarization method from one of three options:

**Method I:** Grooves in sockets CWR-210 and 220 match up with ribs on mating headers. (Mil-DTL-83503 approved method.) For use with non-polarized sockets, the ribs may be quickly, easily and cleanly removed with a simple tool in the field, at a workbench or at the factory prior to shipment.

**Method II:** Plastic key inserted into socket contact prevents mismatching if corresponding header contact is removed.

**Method III:** In addition to mating socket grooves and headers slots, central polarizing key on one socket side (CWR-217 and CWR-227) mates with matching central header slot.



Method I

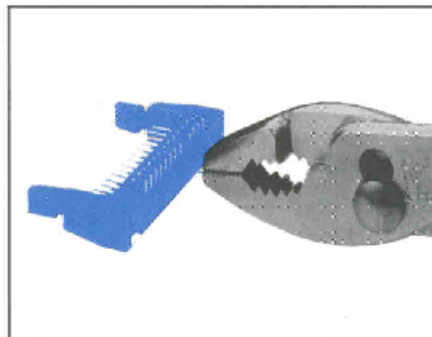

Method II

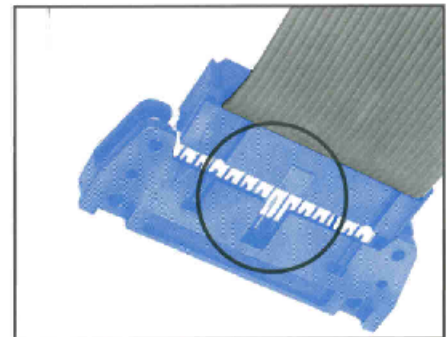

Method III

## Engineering Dimensions

### Dimensions

#### Right Angle Header

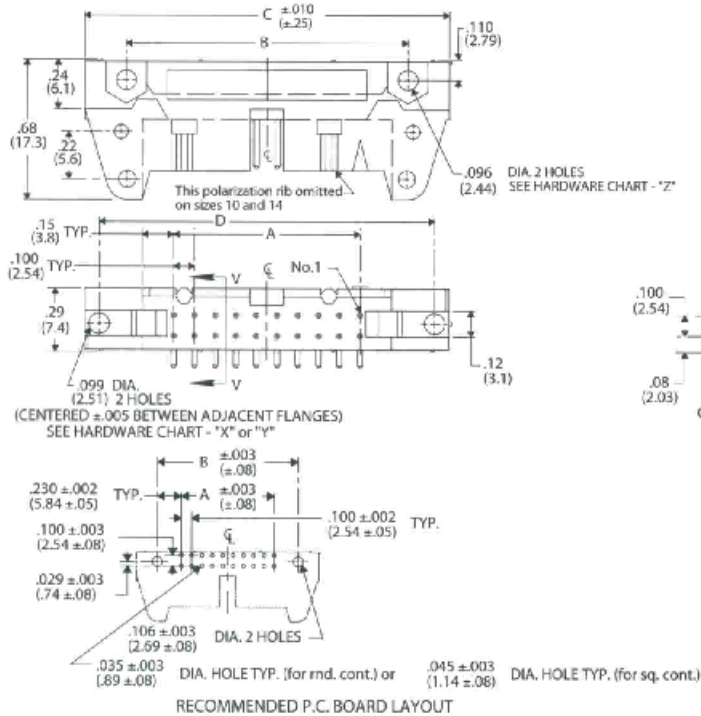

| HARDWARE CHART |          |          |          |
|----------------|----------|----------|----------|
| TYPE           | "X"      | "Y"      | "Z"      |
| THREAD         | 2-56 UNC | 1-72 UNF | 2-56 UNC |
| HEAD           | HEX.     | RND.     | OPT.     |

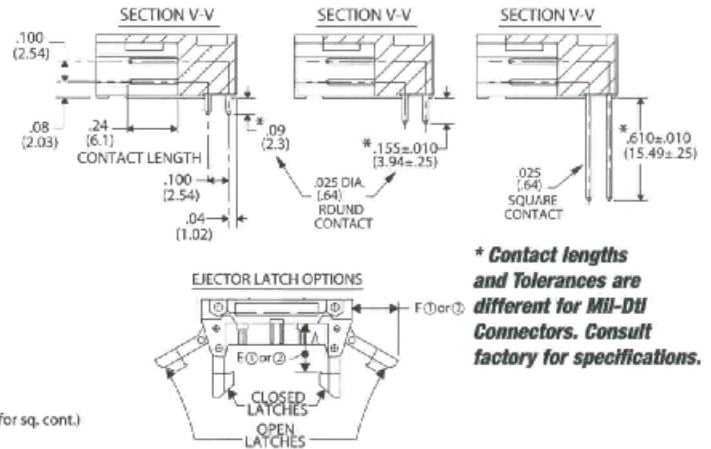

**\* Contact lengths and Tolerances are different for Mil-Dtl Connectors. Consult factory for specifications.**

#### Straight Header

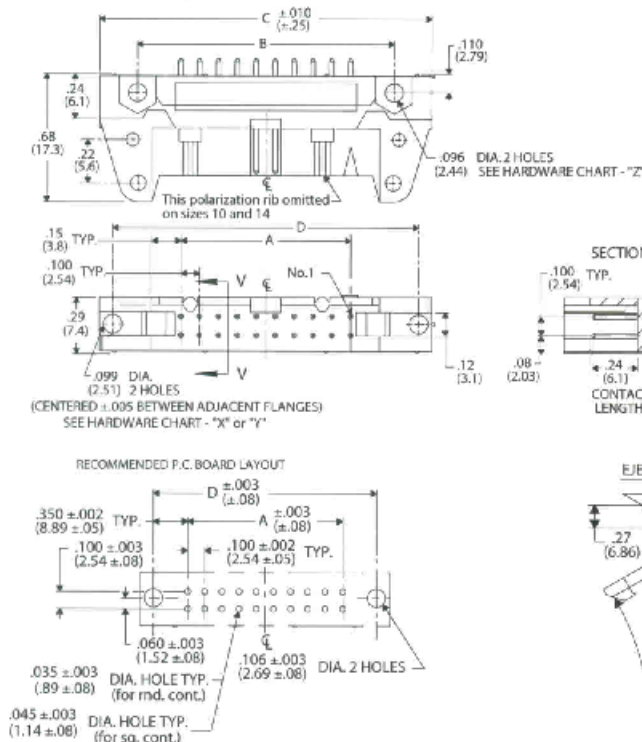

| HARDWARE CHART |          |          |          |
|----------------|----------|----------|----------|
| TYPE           | "X"      | "Y"      | "Z"      |
| THREAD         | 2-56 UNC | 1-72 UNF | 2-56 UNC |
| HEAD           | HEX.     | RND.     | OPT.     |

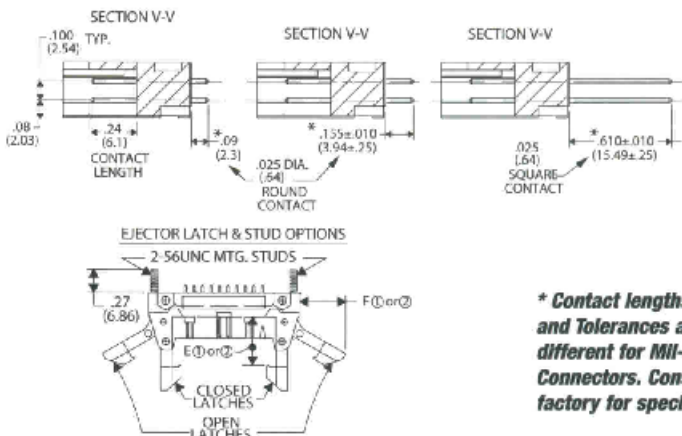

**\* Contact lengths and Tolerances are different for Mil-Dtl Connectors. Consult factory for specifications.**

## Specifications and Ordering Information

### Specifications

- Contacts: phosphor bronze standard
- Contact Plating: 30µ in. gold (in mating area) over 50µ in. nickel, standard; 10µ gold (in mating area) over 50µ in. nickel, optional; 50µ in. gold (in mating area) over 50µ in. nickel, optional
- Insulator Material: UL 94V-0 flame - retardant thermoplastic
- Color: blue
- Operating Temperature: -55°C to +125°C
- Current Rating: 1A (maximum) per contact
- Dielectric Withstand Voltage: greater than 500 Vdc at sea level
- Insulation Resistance: greater than 5 x 10<sup>9</sup> ohms
- U.S. Defense Department Mil-DTL-83503/20, 21, approved

### How to Order Header Connectors

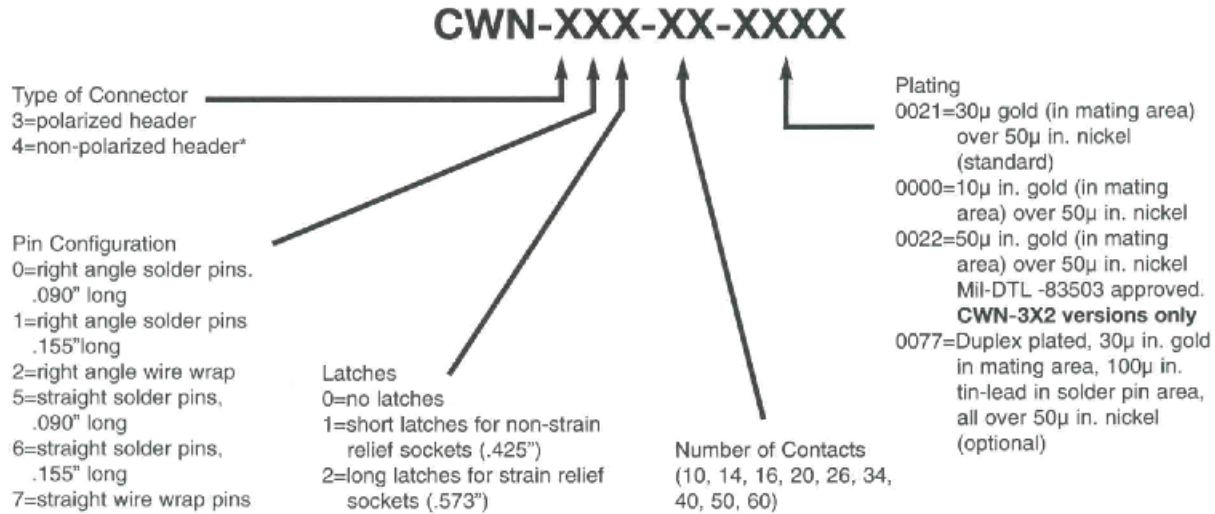

| NO. CONT's | A                | B                | C                | D                | E <sup>①</sup>  | E <sup>②</sup>  | F <sup>①</sup> | F <sup>②</sup> |
|------------|------------------|------------------|------------------|------------------|-----------------|-----------------|----------------|----------------|
| 10         | .400<br>(10.16)  | .860<br>(21.84)  | 1.260<br>(32.00) | 1.100<br>(27.94) |                 |                 |                |                |
| 14         | .600<br>(15.24)  | 1.060<br>(26.92) | 1.460<br>(37.08) | 1.300<br>(33.02) |                 |                 |                |                |
| 16         | .700<br>(17.78)  | 1.160<br>(29.46) | 1.560<br>(39.62) | 1.400<br>(35.56) |                 |                 |                |                |
| 20         | .900<br>(22.86)  | 1.360<br>(34.54) | 1.760<br>(44.70) | 1.600<br>(40.64) | .425<br>(10.80) | .573<br>(14.55) | .40<br>(10.2)  | .51<br>(12.6)  |
| 26         | 1.200<br>(30.48) | 1.660<br>(42.16) | 2.060<br>(52.32) | 1.900<br>(48.26) |                 |                 |                |                |
| 34         | 1.600<br>(40.64) | 2.060<br>(52.32) | 2.460<br>(62.48) | 2.300<br>(58.42) |                 |                 |                |                |
| 40         | 1.900<br>(48.26) | 2.360<br>(59.94) | 2.760<br>(70.10) | 2.600<br>(66.04) |                 |                 |                |                |
| 50         | 2.400<br>(60.96) | 2.860<br>(72.64) | 3.260<br>(82.80) | 3.100<br>(78.74) |                 |                 |                |                |
| 60         | 2.900<br>(73.66) | 3.360<br>(85.34) | 3.760<br>(95.50) | 3.600<br>(91.44) |                 |                 |                |                |

E<sup>①</sup> and F<sup>①</sup> pertains to all headers with short latches

E<sup>②</sup> and F<sup>②</sup> pertains to all headers with long latches

\*Polarizing ribs removed

# Headers - Fully Shrouded

## Engineering Dimensions

### Dimensions

#### Right Angle Header

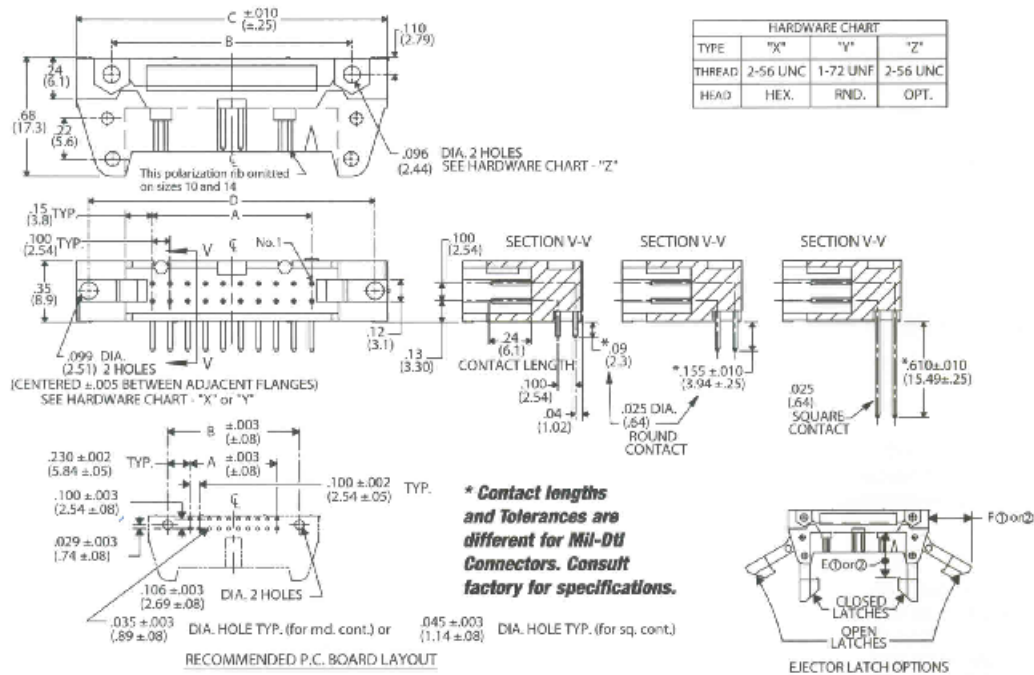

#### Straight Header

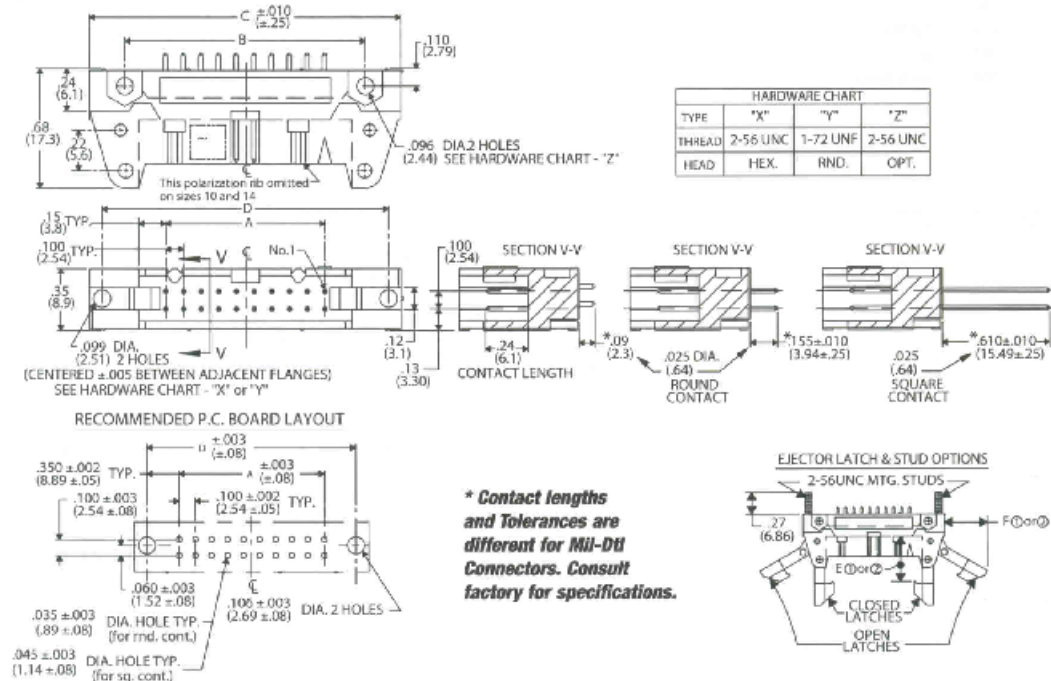



## Specifications and Ordering Information

### Specifications

- Contacts: phosphor bronze standard
- Contact Plating: 30µ in. gold (in mating area) over 50µ in. nickel, standard; 10µ gold (in mating area) over 50µ in. nickel, optional; 50µ in. gold (in mating area) over 50µ in. nickel, optional
- Insulator Material: UL 94V-0 flame - retardant thermoplastic
- Color: blue
- Operating Temperature: -55°C to +125°C
- Current Rating: 1A (maximum) per contact
- Dielectric Withstand Voltage: greater than 500 Vdc at sea level
- Insulation Resistance: greater than 5 x 10<sup>9</sup> ohms
- U.S. Defense Department Mil-DTL-83503/24, and 25 approved

### How to Order Fully Shrouded Header Connectors

#### CWN-XXX-XX-XXXX

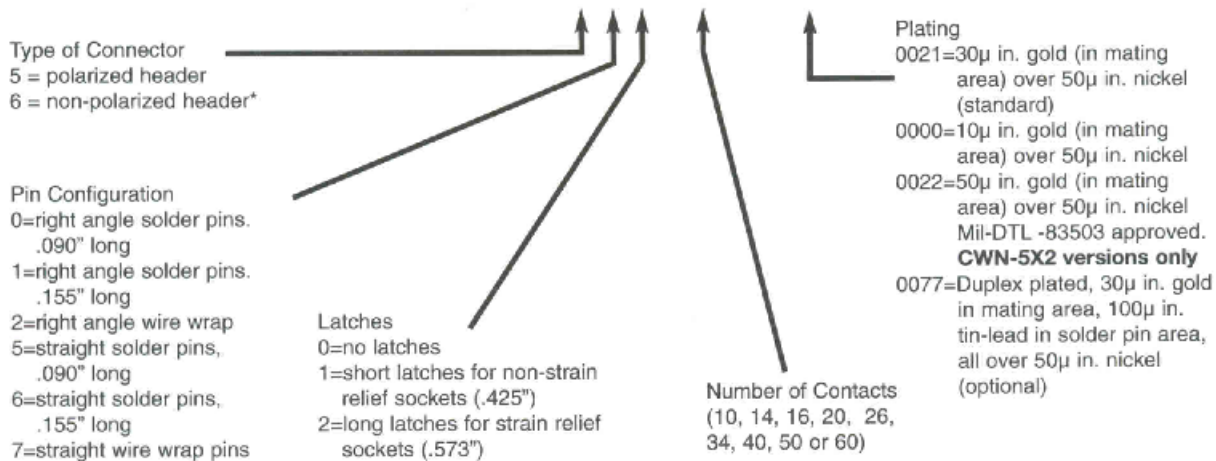

| HEADER DIMENSION CHART |                  |                  |                  |                  |                |                |                |                |                 |                 |               |               |
|------------------------|------------------|------------------|------------------|------------------|----------------|----------------|----------------|----------------|-----------------|-----------------|---------------|---------------|
| NO. CONT'S             | A                | B                | C                | D                | E <sup>①</sup> | E <sup>②</sup> | F <sup>①</sup> | F <sup>②</sup> |                 |                 |               |               |
| 10                     | .400<br>(10.16)  | .860<br>(21.84)  | 1.260<br>(32.00) | 1.100<br>(27.94) | ↑<br>↓         | ↑<br>↓         | ↑<br>↓         | ↑<br>↓         |                 |                 |               |               |
| 14                     | .600<br>(15.24)  | 1.060<br>(26.92) | 1.460<br>(37.08) | 1.300<br>(33.02) |                |                |                |                |                 |                 |               |               |
| 16                     | .700<br>(17.78)  | 1.160<br>(29.46) | 1.560<br>(39.62) | 1.400<br>(35.56) |                |                |                |                |                 |                 |               |               |
| 20                     | .900<br>(22.86)  | 1.360<br>(34.54) | 1.760<br>(44.70) | 1.600<br>(40.64) |                |                |                |                |                 |                 |               |               |
| 26                     | 1.200<br>(30.48) | 1.660<br>(42.16) | 2.060<br>(52.32) | 1.900<br>(48.26) |                |                |                |                | .425<br>(10.80) | .573<br>(14.55) | .40<br>(10.2) | .51<br>(12.6) |
| 34                     | 1.600<br>(40.64) | 2.060<br>(52.32) | 2.460<br>(62.48) | 2.300<br>(58.42) |                |                |                |                |                 |                 |               |               |
| 40                     | 1.900<br>(48.26) | 2.360<br>(59.94) | 2.760<br>(70.10) | 2.600<br>(66.04) |                |                |                |                |                 |                 |               |               |
| 50                     | 2.400<br>(60.96) | 2.860<br>(72.64) | 3.260<br>(82.80) | 3.100<br>(78.74) |                |                |                |                |                 |                 |               |               |
| 60                     | 2.900<br>(73.66) | 3.360<br>(85.34) | 3.760<br>(95.50) | 3.600<br>(91.44) |                |                |                |                |                 |                 |               |               |

E<sup>①</sup> and F<sup>①</sup> pertains to all headers with short latches  
 E<sup>②</sup> and F<sup>②</sup> pertains to all headers with long latches  
 \*Polarizing ribs removed

# Low-Profile Box Headers

Designed to mate with all standard female sockets, with or without center polarizing bump, these completely shrouded, low profile headers reduce height and board area by as much as 50%. Available in straight and right angle solder pins for 1/16" and 1/8" PC boards, and also edgeboard styles.

Removable polarization ribs provide capability for mating with all sockets on .100" x .100" centers.

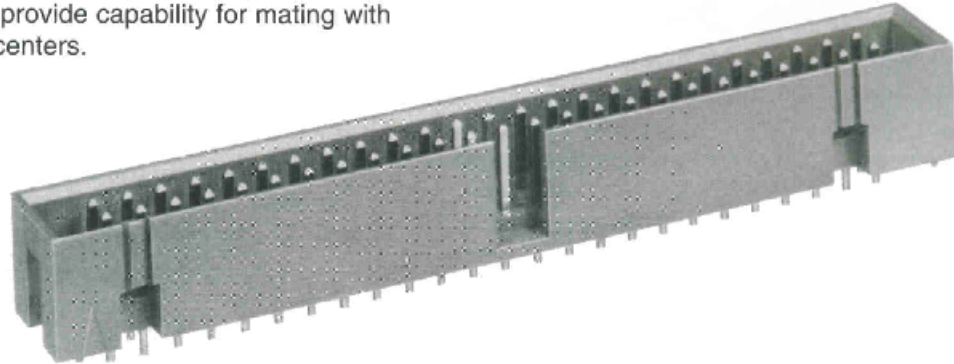

## Materials and Operating Standards

### Specifications:

- Contacts: phosphor bronze standard
- Contact Plating: Selective plated, 30 $\mu$  in. gold (in mating area) over 50 $\mu$  in. nickel, standard
- Insulator Material: UL 94V-0 flame - retardant thermoplastic
- Color: blue
- Operating Temperature: -55°C to +125°C
- Current Rating: 1A (maximum) per contact
- Dielectric Withstand Voltage: greater than 500 Vdc at sea level
- Insulation Resistance: greater than 5 x 10<sup>9</sup> ohms

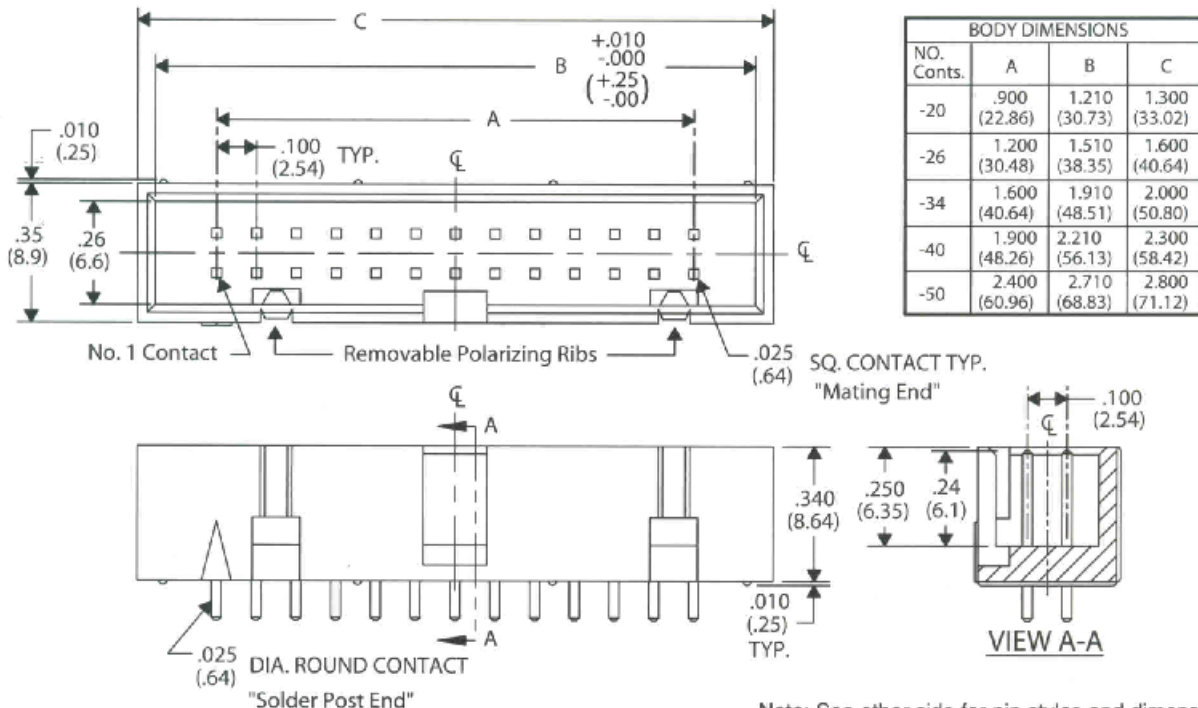

Note: See other side for pin styles and dimensions.

## Box Header with Straight Contacts Recommended PC Board Layout

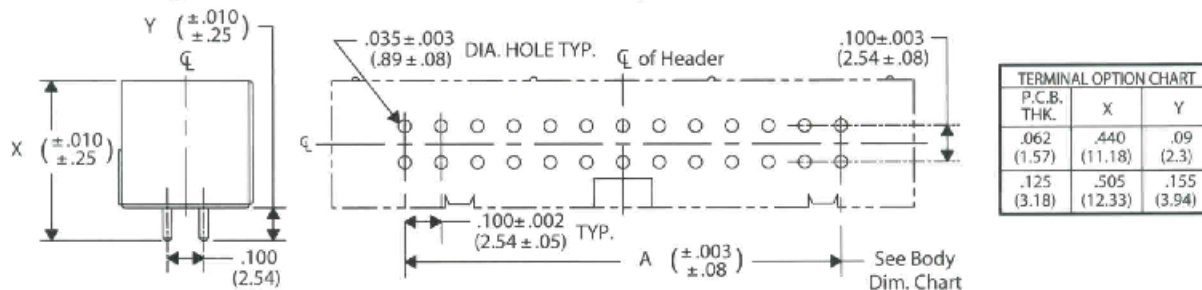

## Box Header with Right Angle Contacts Recommended PC Board Layout

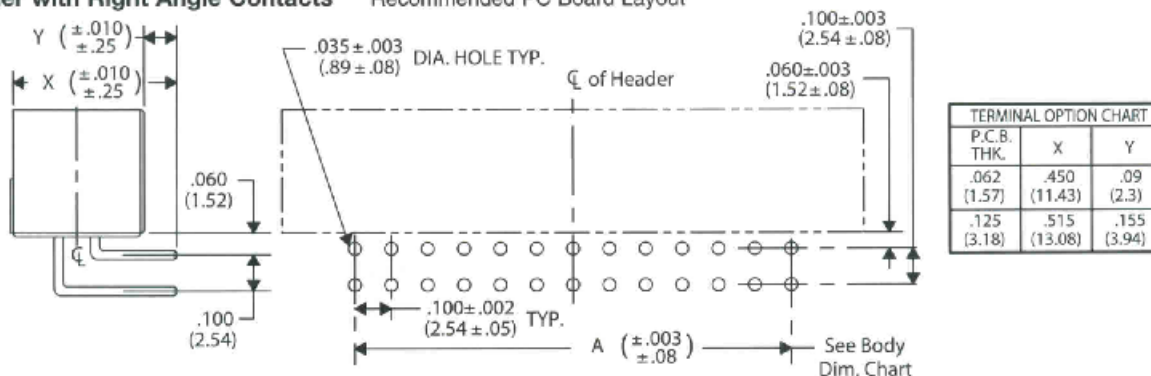

## Edgeboard Box Header Recommended PC Board Pad Layout

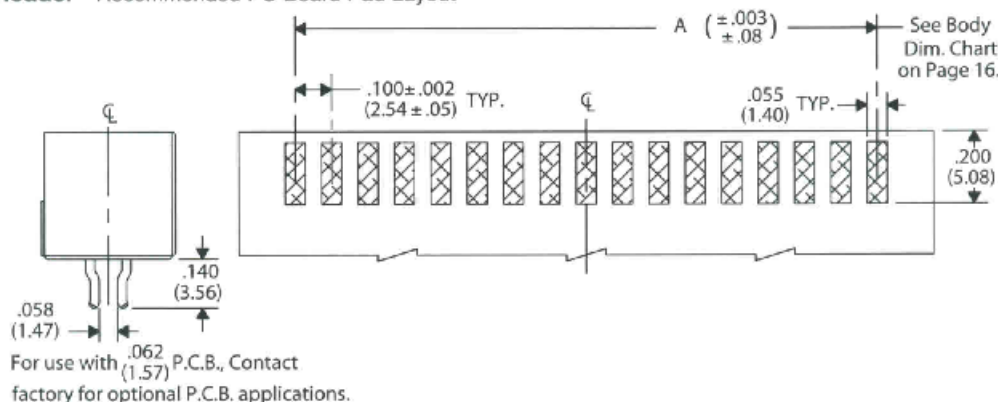

## How to Order Low Profile Box Headers

- Type of Connector  
 33= Straight or Right Angle Polarized Header  
 43= Straight or Right Angle Non-Polarized Header  
 53= Edgeboard Header, Polarized  
 63= Edgeboard Header, Non-Polarized

- Pin Configuration  
 0= Right Angle Solder Pins, .090" long (1/16" PCB)  
 1= Right Angle Solder Pins, .155" long (1/8" PCB)  
 5= Straight Solder Pins, .090" long (1/16" PCB)

- 6= Straight Solder Pins, .155" long (1/8" PCB)  
 8= Straight Solder Pins, .140" long for Edgeboard Header (1/16" PCB)

Number of Contacts (20, 26, 34, 40, 50)

### CWN-XXX-XX-XXXX

- Plating  
 0021= Selective plated, 30µ in. gold (in mating area) over 50µ in. nickel (standard)  
 0000= Selective plated, 10µ in. gold (in mating area) over 50µ in. nickel (optional)  
 0077= Duplex plated, 30µ in. gold in mating area, 100µ in. tin-lead in solder pin area, all over 50µ in. nickel (optional)  
 Other platings available. Consult factory.

# D-Subminiature Connectors-All-Plastic

The D-Subminiature Insulation Displacement Connector is a popular standard for interconnecting many types of electronic equipment—computers and peripherals, instruments, telecommunications and test equipment—throughout the military, industrial, and commercial product sectors.

CW's D-Subminiature connectors consist of four sizes of each of two types of D-Subminiature connectors...pin and socket versions...mating to standard 9, 15, 25, and 37

conductor cable. All CW D-Subminiature connectors incorporate two basic series of patents assuring contact integrity with the cable as well as the mating connector. These connectors are UL and CSA listed and are designed to meet the standards of Mil-DTL-83503. They are fully interchangeable and mate with other standard D-Subminiature connectors.

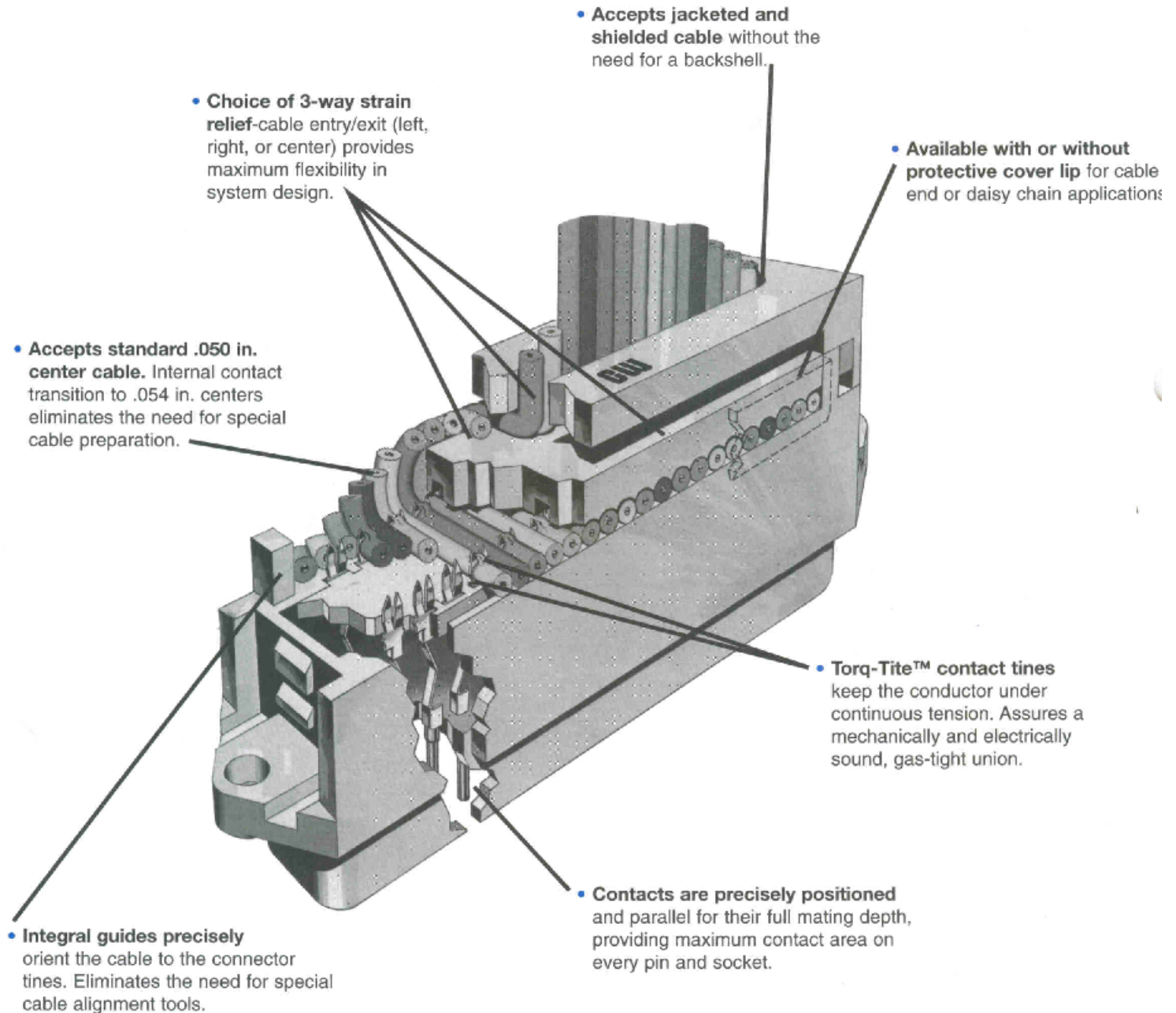

## Contact

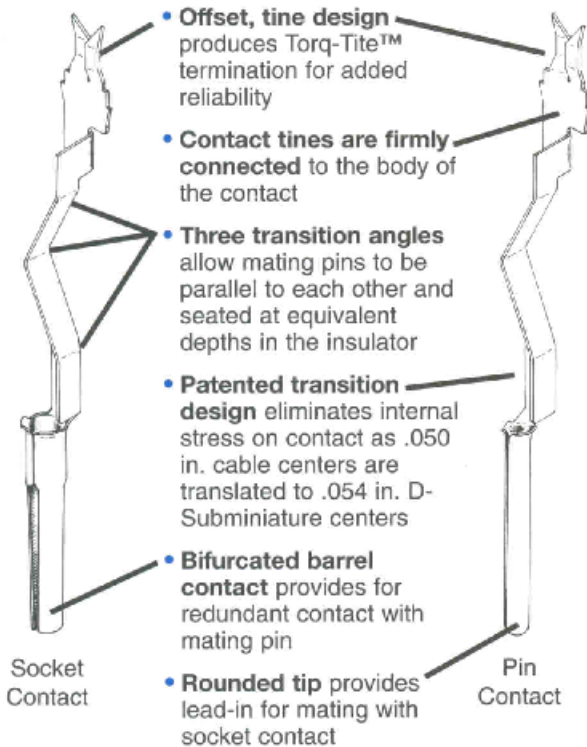

- **Offset, tine design** produces Torq-Tite™ termination for added reliability
- **Contact tines are firmly connected** to the body of the contact
- **Three transition angles** allow mating pins to be parallel to each other and seated at equivalent depths in the insulator
- **Patented transition design** eliminates internal stress on contact as .050 in. cable centers are translated to .054 in. D-Subminiature centers
- **Bifurcated barrel contact** provides for redundant contact with mating pin
- **Rounded tip** provides lead-in for mating with socket contact

## D-Subminiature Features

- 9-, 15-, 25-, 37- pin or socket versions available
- Interchangeable and mateable with other D's
- UL, CSA listed
- Patented 0.050/0.054 in. (1.27/1.38mm) cable/connector transition
- Fully mating, precisely positioned contacts
- Patented off-set contact tines assure gas-tight connection
- Rugged, lightweight UL 94 V-O thermoplastic construction
- No exposed metal
- Positive polarization via D-shaped contact shroud
- All contacts numbered
- Accepts 28 AWG solid or stranded and 30 AWG solid conductors in both shielded and unshielded flat cables
- Positive, fast termination. No special assembly tooling required
- Simple, non-destructive removal of covers
- Three strain relief options available
- Easily daisy chained
- Hardware for a variety of mounting methods available
- Jackscrew design (CWN-HK-01) accepts a standard miniature banana plug for grounding
- Manufactured under U.S. patent 3,990,767.

## Patented Contact Transition

The CW contact transition is unique in that all contacts are precisely positioned to provide full contact with their mating member at every pin and socket. CW's internal transition from .050 in. to .054 in. centers eliminates the need for special cables or special cable preparation. It also eliminates the possibility of pin misalignment, and excessive insertion/withdrawal forces, providing maximum contact integrity, minimum contact resistance, and long term reliability.

## Three-way Strain Relief

CW's exclusive design allows for three-way strain relief. This feature offers you a choice of three cable entry/exit options providing maximum flexibility and system design.

## Assembly That's a Snap

CW supplies a cover factory preassembled to the base, with the cover in a detented "up" position to allow sufficient space to insert the cable. There is no need for special cable alignment tooling. Built-in guides in both the cover and base orient the cable conductors to the connector contacts.

## Removable Cover

CW insulation displacement D-Subminiature connectors permit simple, non-destructive removal of the cover for maintenance and connector reuse—the open end of a paper clip and a special groove in the mounting flange (standard on all CW D's) is all that is required to remove the cover.

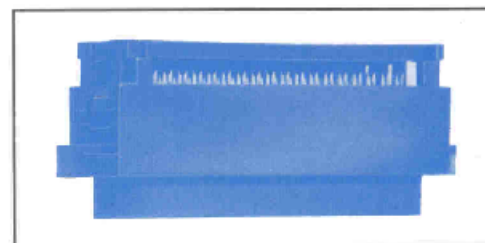
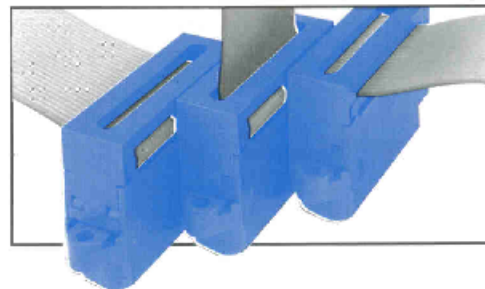
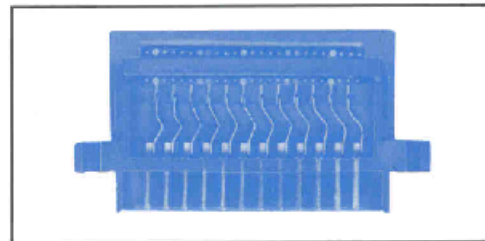

# D-Subminiature-All-Plastic

## Engineering Dimensions

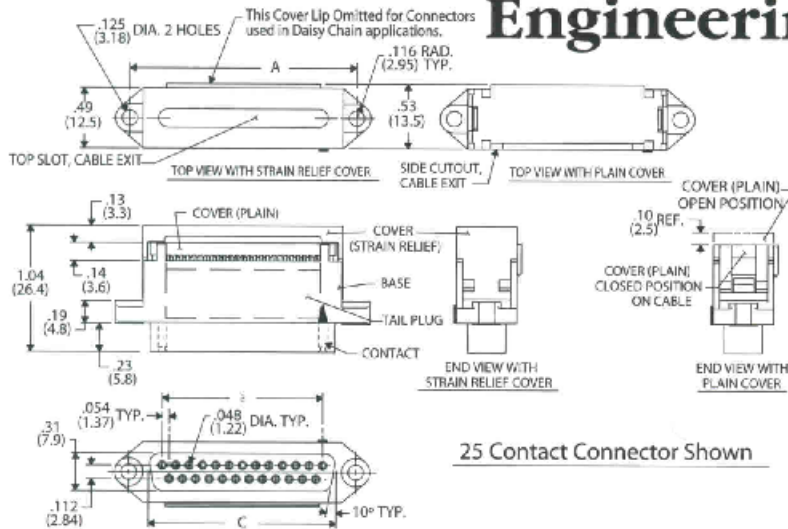

### Socket D Connector

| CONNECTOR DIMENSIONS |                  |                  |                  |
|----------------------|------------------|------------------|------------------|
| NO. CONTS.           | A                | B                | C                |
| 9                    | .984<br>(24.99)  | .434<br>(11.02)  | .640<br>(16.26)  |
| 15                   | 1.312<br>(33.32) | .760<br>(19.30)  | .966<br>(24.54)  |
| 25                   | 1.852<br>(47.04) | 1.303<br>(33.10) | 1.510<br>(38.35) |
| 37                   | 2.500<br>(63.50) | 1.955<br>(49.66) | 2.162<br>(54.91) |

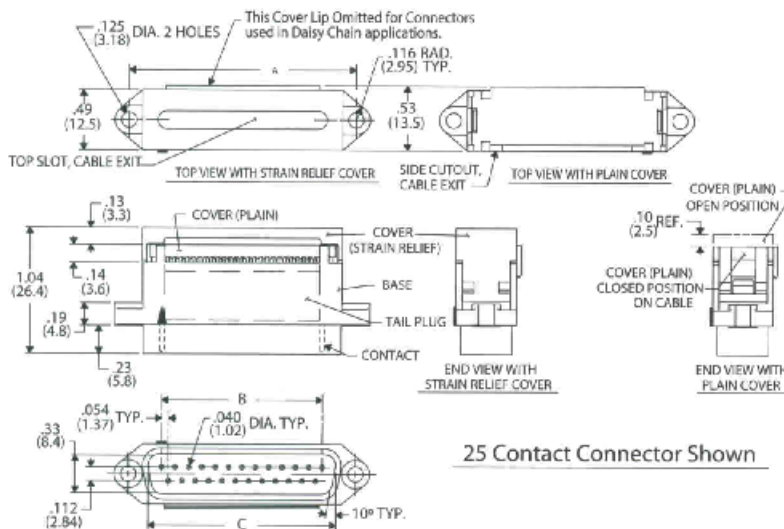

### Pin D Connector

| CONNECTOR DIMENSIONS |                  |                  |                  |
|----------------------|------------------|------------------|------------------|
| NO. CONTS.           | A                | B                | C                |
| 9                    | .984<br>(24.99)  | .434<br>(11.02)  | .660<br>(16.76)  |
| 15                   | 1.312<br>(33.32) | .760<br>(19.30)  | .986<br>(25.04)  |
| 25                   | 1.852<br>(47.04) | 1.303<br>(33.10) | 1.530<br>(38.86) |
| 37                   | 2.500<br>(63.50) | 1.955<br>(49.66) | 2.182<br>(55.42) |

## Hardware Mounting Kits for All-Plastic D-Connectors

To order, specify CWN-HK-XX.

### CWN-HK-01

For midspan splices or panel mounting with 2-56

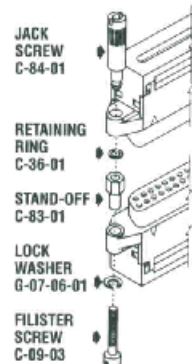

### CWN-HK-02

For midspan splices with metal-shell D connectors using 4-40 hardware.

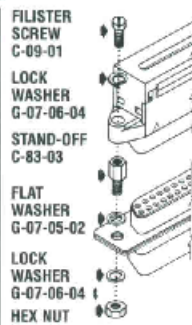

### CWN-HK-03

Two 4-40 threaded jack screws and retaining rings for midspan splices.

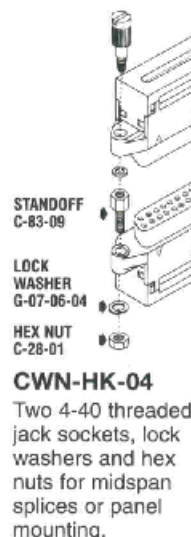

### CWN-HK-04

Two 4-40 threaded jack sockets, lock washers and hex nuts for midspan splices or panel mounting.

### CWN-HK-05

Two 4-40 threaded jack screws and thread press-fit inserts\* for midspan cable splices. \*requires connector mounting holes enlarged to .150".

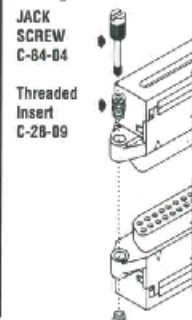

### CWN-HK-06

Two 2-56 threaded screws, four threaded press-fit inserts, two hex nuts and lock washers for economical midspan splices.

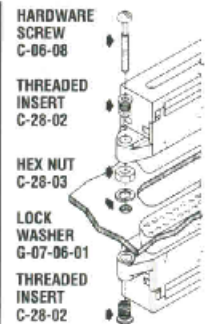

# Specifications and Ordering Information

## Specifications

- Contacts: phosphor bronze standard
- Contact Plating: 30µ in. gold (in mating area) over 50µ in. nickel, standard; 10µ in. gold (in mating area) over 50µ in. nickel, optional; 50µ in. gold (in mating area) over 50µ in. nickel, optional; 100µ in. 60/40 tin-lead, optional
- Insulator material: UL 94V-0 flame - retardant thermoplastic
- Cover pull-off force 8 oz/contact minimum (force applied along contacts' primary axes)
- Strain Relief Cover: standard
- Withdrawal force 2-8 oz/contact, typical
- Color: blue
- Operating temperature: -55° to +125°C
- Current 1A(maximum) per contact
- Dielectric Withstand Voltage: 500 Vdc (sea level)
- Insulation resistance: 5 x 10<sup>9</sup> ohms

## How to Order All-Plastic D-Subminiature Connectors

### Type of Connector

- 182=D-Subminiature for cable end terminations, pin contact (Standard)
- 183=D-Subminiature for cable end terminations, socket contact (Standard)
- 180=D-Subminiature connector for daisy chain applications, pin contact
- 181=D-Subminiature connector for daisy chain applications, socket contact

### CWR-XXX-XX-00XX



Number of Contacts  
(9, 15, 25, 37)

### Plating

- 0021=30µ in. gold (in mating area) over 50µ in. nickel (standard)
- 0000=10µ in. gold (in mating area) over 50µ in. nickel
- 0055=50µ in. gold (in mating area) over 50µ in. nickel
- 0003=100µ in. tin-lead

## How to Order D-Subminiature Cable Assemblies

Cable assemblies with two D-Subminiature connectors on a prescribed length of gray flat cable are available with the connectors oriented per drawings 19-1, 19-2, or 19-3 (#1 contacts oriented to red conductor.) For other lengths, orientations, numbers or combinations of connectors, contact the factory or your local value-added distributor.

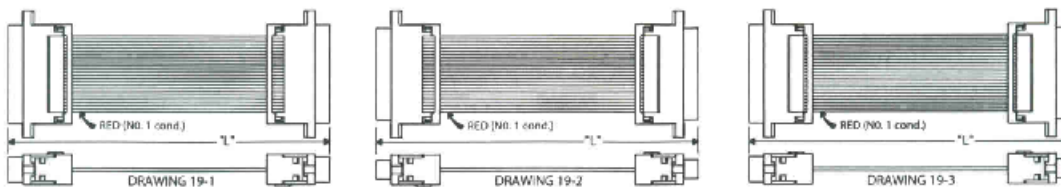

### CA-XX-9X0X

Number of Conductors  
(9, 15, 25, 37)

### Type of Connectors

- 6=Two D-Subminiature connectors with pin contacts, CWR-182-XX-0021 (see drawing 19-1)
- 7=Two D-Subminiature connectors with socket contacts, CWR-183-XX-0021 (see drawing 19-2)
- 8=A D-Subminiature connector with pin contacts, CWR-182-XX-0021, on one end and a D-Subminiature connector with socket contacts, CWR-183-XX-0021, on the other end (see drawing 19-3)

### Final assembly length "L"

- 1=3"±1/8"
- 2=6"±1/8"
- 3=12"±1/4"
- 4=24"±1/4"
- 5=48"±1/4"

# D-Subminiature connectors with metal face and EMI/RFI shield

## The Problem:

Stray Electromagnetic Interference (EMI) and Radio Frequency Interference (RFI) emitted from unshielded cables, connectors, and assemblies can affect the performance of electronic devices within the range of these emissions. The Federal Communications Commission requires EMI/RFI shielding to standards defined in F.C.C. Docket 20780, Part 15 on all newly manufactured equipment. Connectors, cable, and assemblies, if an integral part of this equipment, are within the scope of the F.C.C. decree and must be appropriately shielded.

## The CW Solution:

CW makes available a choice of two solutions. Select the system that best solves your EMI/RFI emission problem.

**METAL-FACED D-SUBMINIATURE—**A metal face forms the front of your D-Subminiature connector and shields high-frequency radiation that emanates principally from the point of external interconnection. These connectors also mate with traditional metal-faced D connectors.

**EMI/RFI SHIELD—**A bright tin-plated metal shield can be added to the METAL-FACED connector to form a complete metal enclosure. Laboratory tests show that our Subminiature D connector enclosed in our assembled shield can reduce strays by up to 80dB. Performance comparison and test results are indicated graphically in the chart at right. When terminated to jacketed-and-shielded flat cable, properly stripped to expose an external conductive surface, the shielding interfaces redundantly with CW's conductive shield placing the entire assembly at "ground". CW's shield can be used on either cable end terminations or in "daisy chain" terminations along the cable. METAL SHIELDS are available to cover 9, 15, 25, and 37 pin or socket Subminiature D connectors. CW's METAL SHIELDS are designed for easy and rapid assembly to our METAL-FACED Subminiature D-connectors. No supplemental fasteners or assembly tools are required.

## Test Results

Radiated Emission Comparison  
Unshielded vs. CW Shielded D-Subminiatures Assemblies

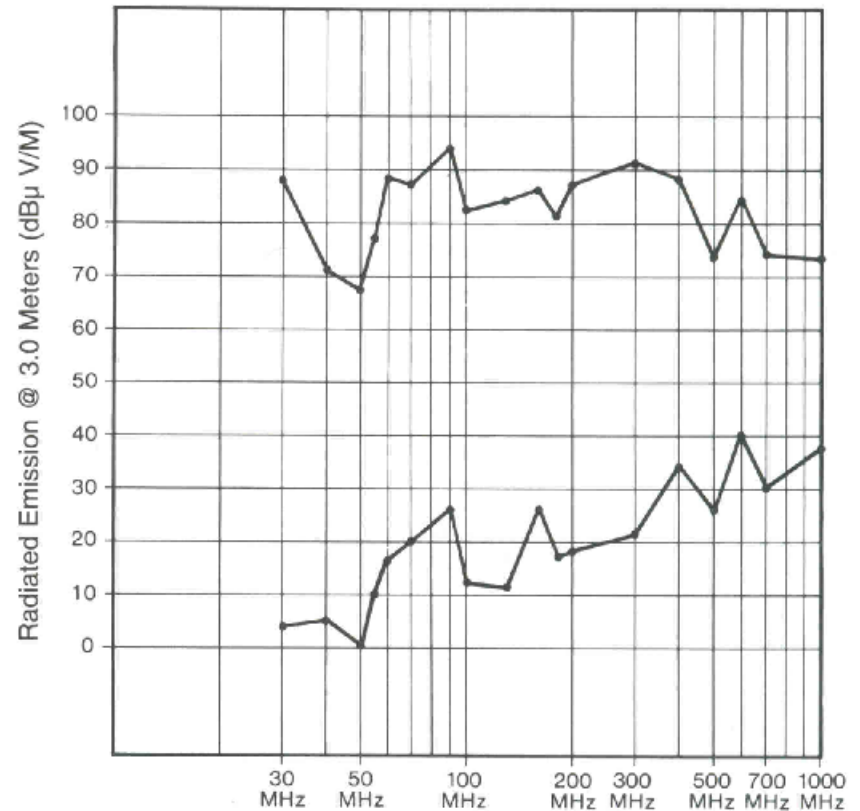

## CW metal-faced D-Subminiature connector with assembled EMI/RFI shield

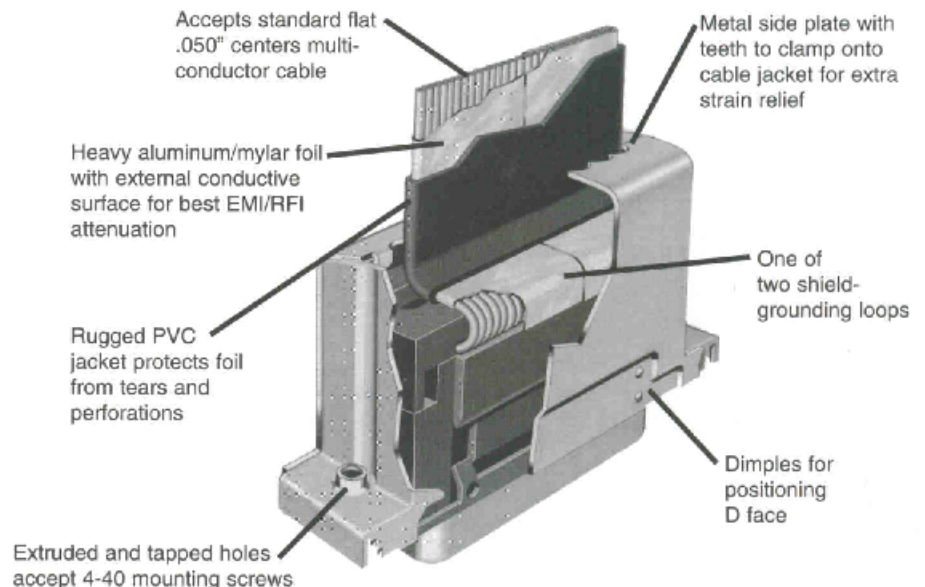



## D-Subminiature connector with metal face

CW metal faced D-Subminiature connectors are ideal for input/output applications and interconnecting electronic equipment. These connectors are designed to the applicable standards of Mil-DTL-24308 and are interchangeable and mateable with other connectors so designed.



Metal flange can minimize radiation at I/O ports

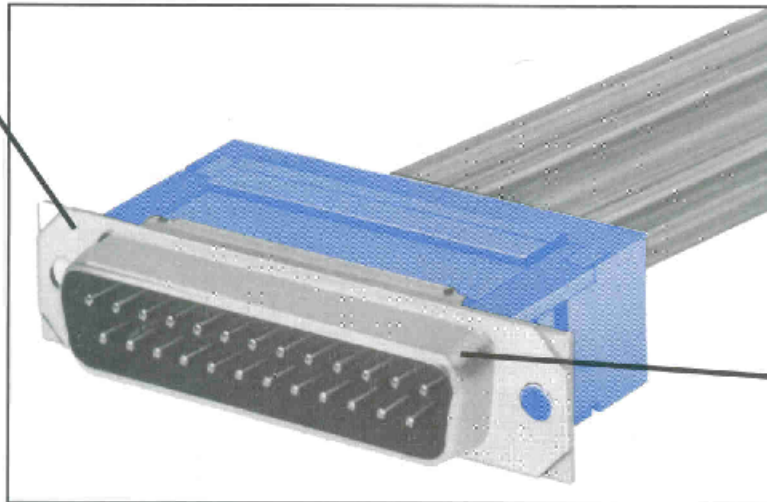

Metal face provides proper mate for other metal-faced D connectors

## Assemble an EMI/RFI shield to our D-Subminiature connector in a snap

After terminating the connector to C-03-021 or C-03-031 style jacketed and shielded flat cable, slide the D-Subminiature connector with metal face into the preassembled shield.

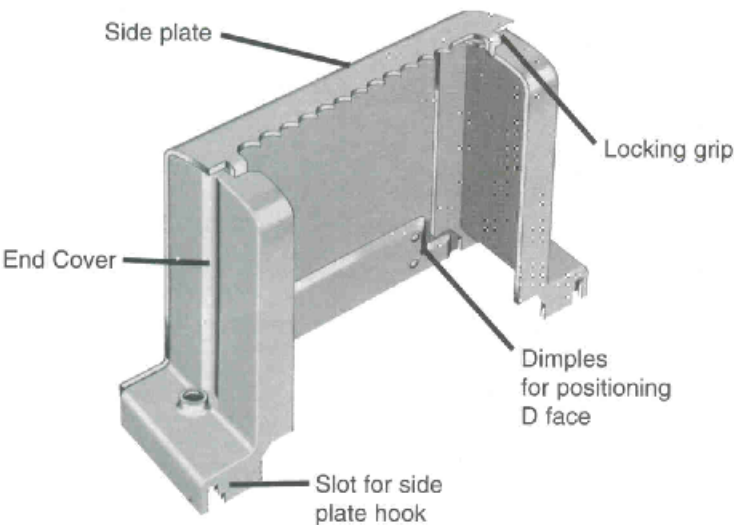

Hook the remaining side plate into place and snap together

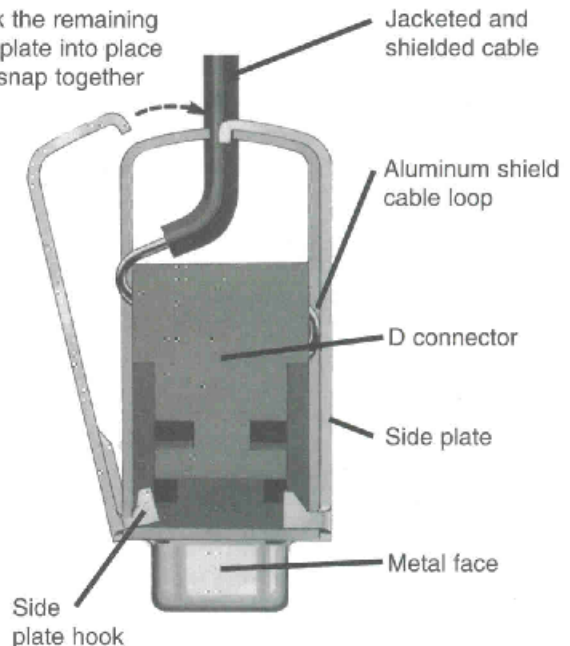

## D-Subminiature connectors with metal face (Bright tin-plated C.R.S.)

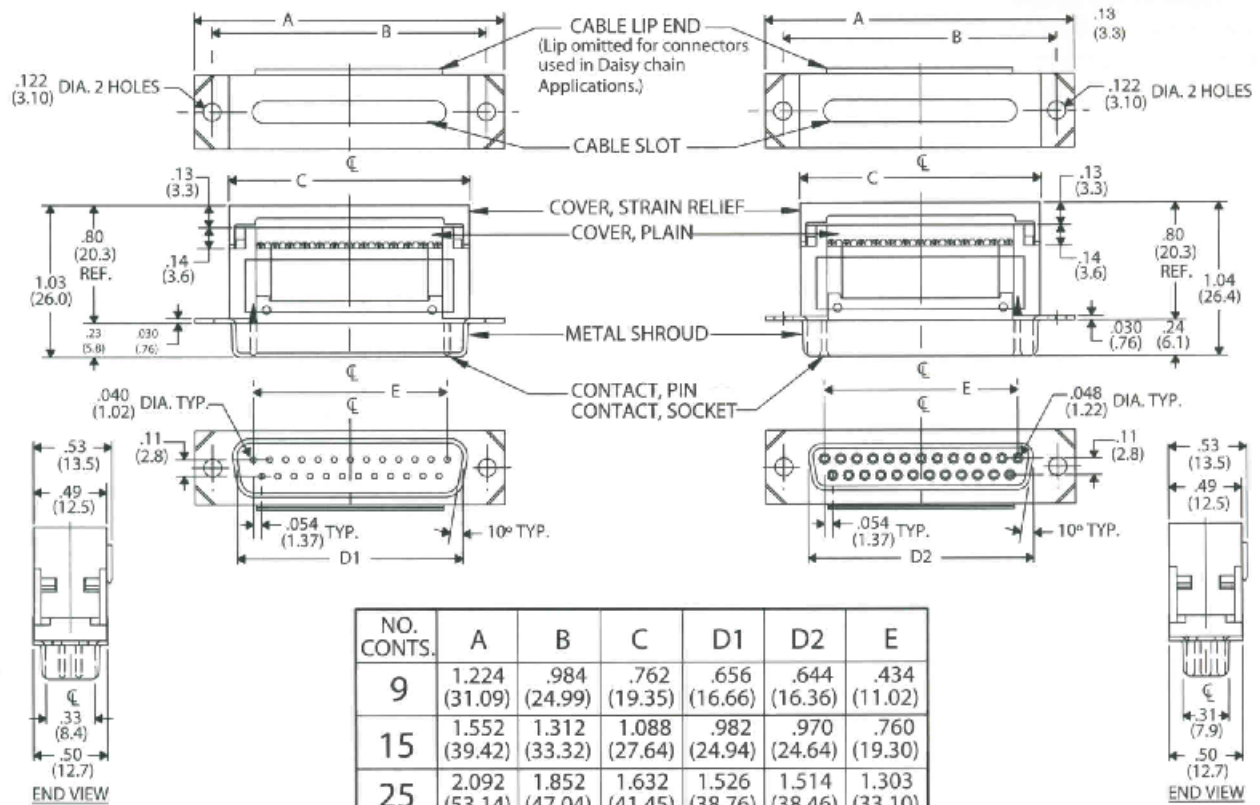

25 CONTACT CONNECTOR (SHOWN)

## EMI/RFI Shielded (Bright tin-plated C.R.S.)

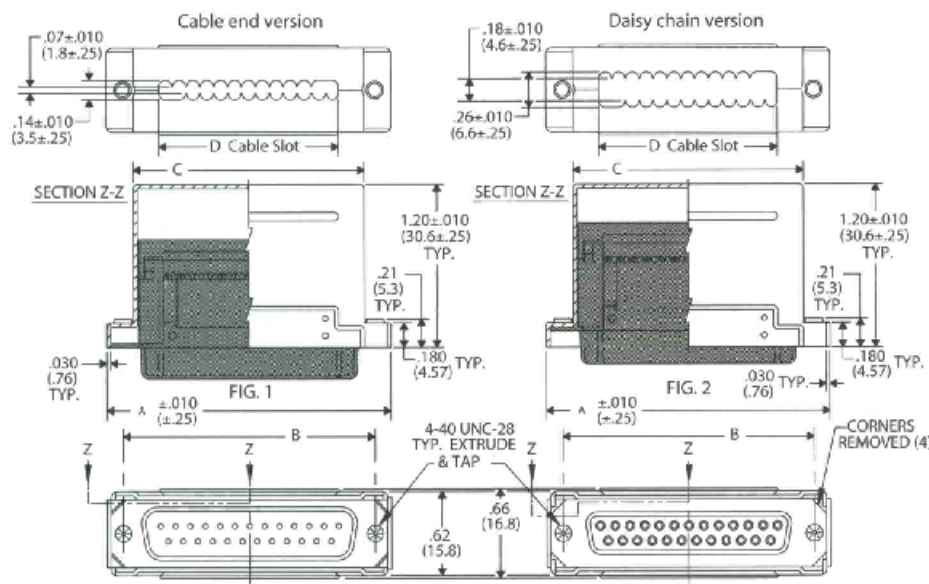

| NO. CONTS. | A             | B             | C             | D             |
|------------|---------------|---------------|---------------|---------------|
| 9          | 1.284 (32.61) | .984 (24.99)  | .830 (21.08)  | .550 (13.97)  |
| 15         | 1.612 (40.94) | 1.312 (33.32) | 1.158 (29.41) | .856 (21.74)  |
| 25         | 2.152 (54.66) | 1.852 (47.04) | 1.698 (43.13) | 1.366 (34.70) |
| 37         | 2.800 (71.12) | 2.500 (63.50) | 2.346 (59.59) | 1.978 (50.24) |

Note: EMI/RFI shield will accept either pin or socket connector in standard (Fig. 1) or recessed (Fig. 2) mounting configurations, as shown.

## Hardware Mounting Kits for Metal Faced D-Connectors

To order, specify CWN-HK-XX.

### CWN-HK-07

Two 4-40 screws and washers for midspan splices of two CW D-Subminiature connectors with the CW EMI/RFI shield.

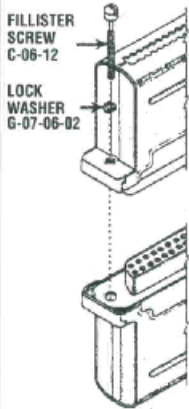

### CWN-HK-08

Two 4-40 standoffs with lock washers and hex nuts for front panel mounting of D-Subminiature connector with metal face.

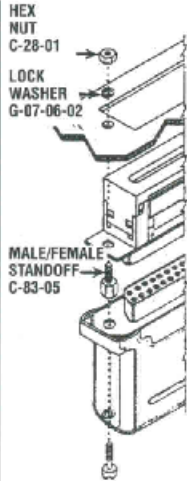

### CWN-HK-09

Two 4-40 screws, lock washers and retaining clips for mounting other manufacturers' D-Subminiatures in the CW shield and mating to CWN-HK-10.



### CWN-HK-10

Two 4-40 standoffs with lock washers and nuts for rear panel mounting of D-Subminiature connector with metal face.

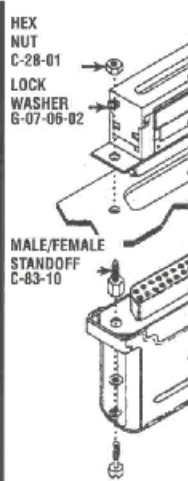

### CWN-HK-11

Two 4-40 screws, lock washers and four retaining clips for mid span splices of other manufacturers' D-Subminiature connectors in the CW shield.

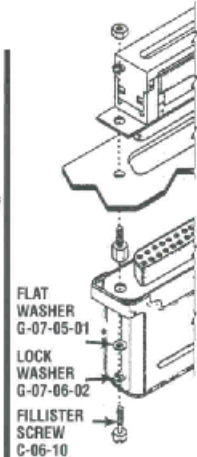
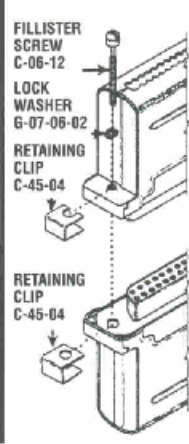

### CWN-HK-12

Two 4-40 screws with four washers for mating CW D-Subminiature connectors with the CW EMI/RFI shield to front or rear panel mounted connector. \*Flat washer not used when mated with front panel mounted connector.

## How to Order D-Subminiature Connectors with Metal Face

- Type of Connector
- 282=D-Subminiature with metal face for cable end terminations, pin contact (Standard)
  - 283=D-Subminiature with metal face for cable end terminations, socket contact (Standard)
  - 280=D-Subminiature connector with metal face for daisy chain applications, pin contact
  - 281=D-Subminiature connector with metal face for daisy chain applications, socket contact

**CWR-XXX-XX-00XX**

- Plating
- 0021=30µ in. gold (in mating area) over 50µ in. nickel (standard)
  - 0000=10µ in. gold (in mating area) over 50µ in. nickel
  - 0022=50µ in. gold (in mating area) over 50µ in. nickel **Mil-DTL-24308 approved.**
  - 0003=100µ in. tin-lead

Number of Contacts  
(9, 15, 25 or 37)

## How to Order EMI/RFI Shield

- Type of Shield
- 292=Shield for cable end terminations
  - 290=Shield for daisy chain terminations

**CWN-XXX-XX-8901**

Size  
(09, 15, 25, 37)

Note: For information on 100% tested, ready-to-use cable assemblies, contact the factory or your local value-added distributor.

# Card Edge Connectors

The card edge connector provides a fast means for connecting/disconnecting single, double-sided or multi-layer printed circuit boards.

Contact force consistency is obtained through the use of a long cantilevered contact having a minimum deflection angle and an extended self-cleaning, wiping action. These contacts ensure positive connection to the board, even when pad surfaces are irregular.

Good contact pressure is maintained with minimum wear on PC board pads, even in hostile environments, and after numerous insertions and withdrawals or shock and vibration.

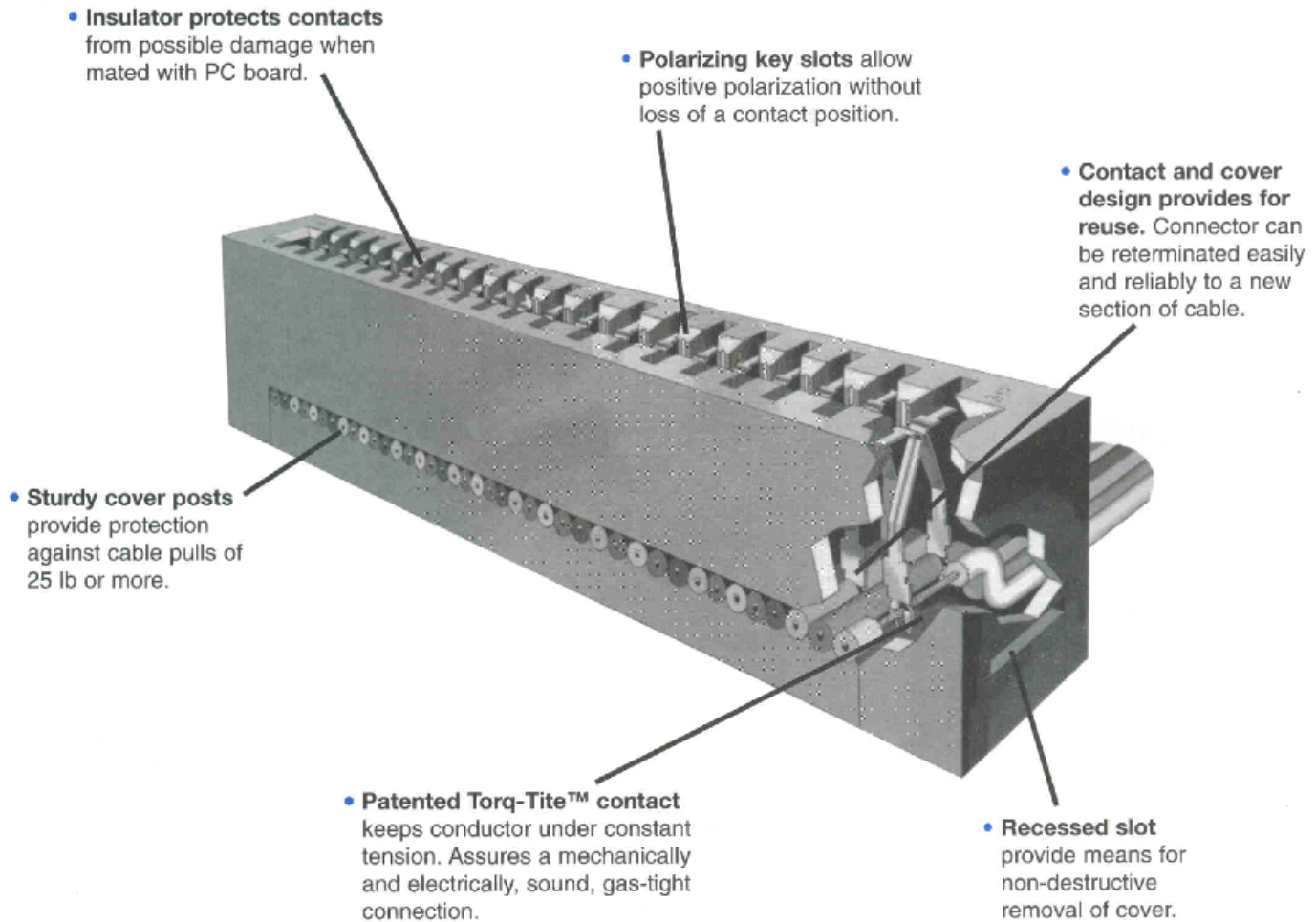

## Contact

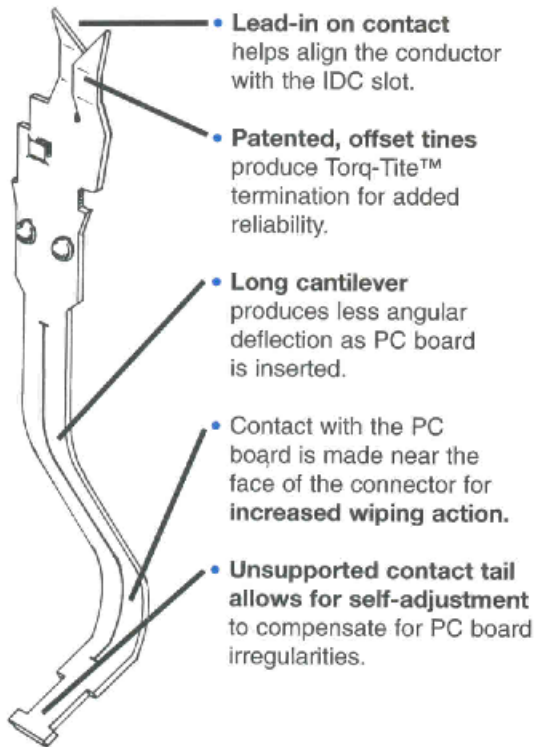

- **Lead-in on contact** helps align the conductor with the IDC slot.
- **Patented, offset tines** produce Torq-Tite™ termination for added reliability.
- **Long cantilever** produces less angular deflection as PC board is inserted.
- Contact with the PC board is made near the face of the connector for **increased wiping action.**
- **Unsupported contact tail** allows for self-adjustment to compensate for PC board irregularities.

## Card Edge Connector Features

- 10, 20, 26, 34, 40, and 50 contact versions.
- Compatible with various PC board thicknesses, from .032 in. to .070 in. thick.
- Standard gold-plated phosphor bronze contacts; tin-lead plated contacts optional.
- Can be daisy-chained or applied in cable end terminations.
- Factory pre-assembled cover minimizes assembly time.
- Available with or without mounting flanges.
- Dependable long cantilever contact design maintains consistent pressure even after repeated matings with PC boards. Insures a long insertion/withdrawal cycle life and a good self-cleaning wipe on each PC board pad.
- Self-adjusting contact compensates for variations in PC board thickness.
- Closed entry protection prevents possible damage caused by PC board irregularities.

## Strain Relief

Strain relief is an integral part of CW Card Edge connector. A strain relief lip is molded into the connector body. Upon installation of the cover, this lip causes a strain relief bend in the cable that prevents forces applied to the cable from being transferred to the IDC termination.

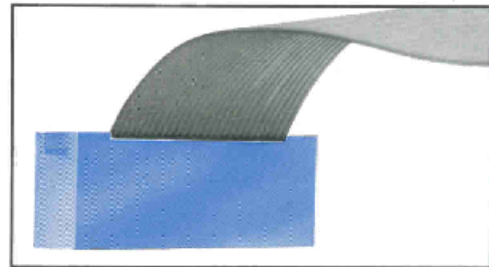

## Polarization

Positive polarization is available on all CW card edge connectors. A polarizing key, inserted into a V-slot located between any two contacts, fits into a corresponding .037 in. slot cut into the PC board. This technique not only provides positive polarization without loss of a contact position, but also helps ensure precise alignment of the contacts to the PC board's pads.

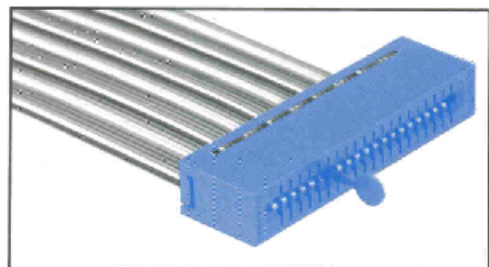

## Assembly

Assembling these connectors is both fast and easy using only a simple bench press. The connector body is designed to orient the cable to the contact tines, and the factory preassembled cover permits termination of all conductors in one step—simply apply opposing parallel forces on the connector cover and base.

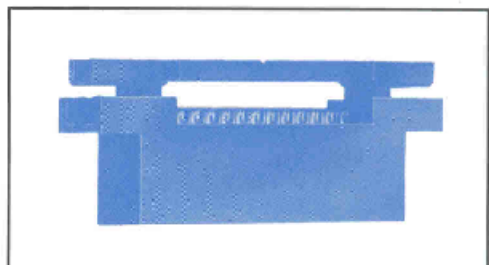

# Card Edge Connectors

## Engineering Dimensions

### Dimensions

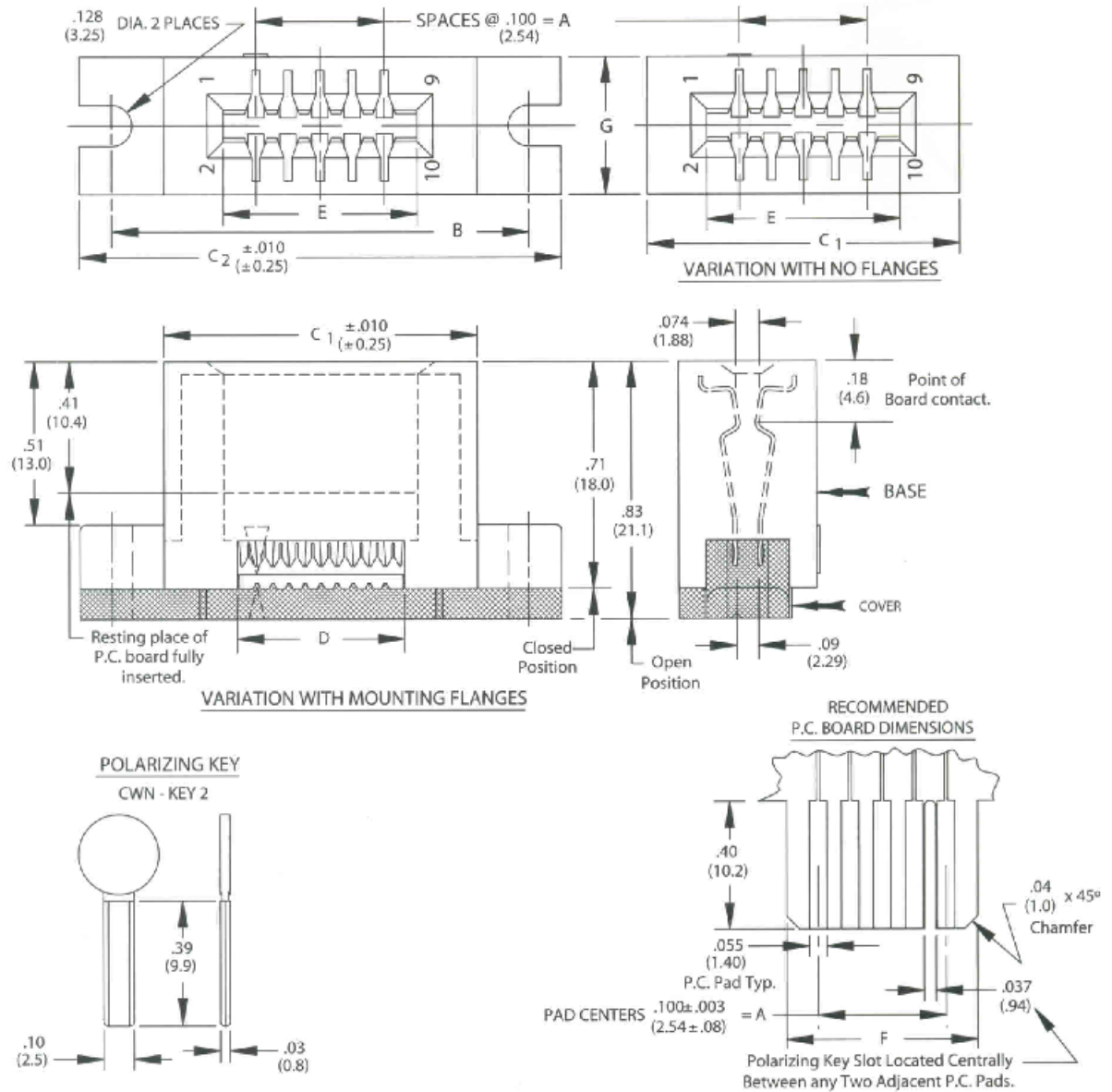

| CONNECTOR DIMENSIONS |                  |                  |                  |                  |                  |                  |                  |               |
|----------------------|------------------|------------------|------------------|------------------|------------------|------------------|------------------|---------------|
| NO. CONTS.           | A                | B                | C <sub>1</sub>   | C <sub>2</sub>   | D                | E                | F                | G             |
| 10                   | .400<br>(10.16)  | 1.300<br>(33.02) | .976<br>(24.79)  | 1.500<br>(38.10) | .520<br>(13.21)  | .604<br>(15.34)  | .596<br>(15.14)  | .43<br>(10.9) |
| 20                   | .900<br>(22.86)  | 1.800<br>(45.72) | 1.476<br>(37.49) | 2.000<br>(50.80) | 1.020<br>(25.91) | 1.104<br>(28.04) | 1.096<br>(27.84) | .43<br>(10.9) |
| 26                   | 1.200<br>(30.48) | 2.100<br>(53.34) | 1.776<br>(45.11) | 2.300<br>(58.42) | 1.320<br>(33.53) | 1.404<br>(35.66) | 1.396<br>(35.46) | .43<br>(10.9) |
| 34                   | 1.600<br>(40.64) | 2.500<br>(63.50) | 2.176<br>(55.27) | 2.700<br>(68.58) | 1.720<br>(43.69) | 1.804<br>(45.82) | 1.796<br>(45.62) | .43<br>(10.9) |
| 40                   | 1.900<br>(48.26) | 2.800<br>(71.12) | 2.476<br>(62.89) | 3.000<br>(76.20) | 2.020<br>(51.31) | 2.104<br>(53.44) | 2.096<br>(53.24) | .43<br>(10.9) |
| 50                   | 2.400<br>(60.96) | 3.400<br>(86.36) | 2.976<br>(75.59) | 3.900<br>(99.06) | 2.520<br>(64.01) | 2.604<br>(66.14) | 2.596<br>(65.94) | .44<br>(11.2) |

# Specifications and Ordering Information

## Specifications

- Contacts: phosphor bronze standard.
- Contact Plating: 30µ in. gold (in mating area) over 50µ in. nickel, standard; 10µ in. gold (in mating area) over 50µ in. nickel, optional; 50µ in. gold (in mating area) over 50µ in. nickel, optional; 100µ in. tin-lead optional
- Insulator Material: UL 94V-0 flame - retardant thermoplastic
- Color: blue
- Operating temperature: -55° to +125°C
- Current Rating: 1A(maximum) per contact
- Dielectric Withstand Voltage: greater than 500 Vdc at sea level
- Insulation Resistance: greater than 5 x 10<sup>9</sup> ohms
- Cover pull-off force 8 oz/contact min. (force along contacts' primary axes)

## How to Order Card Edge Connectors

### CWR-XXX-XX-00XX

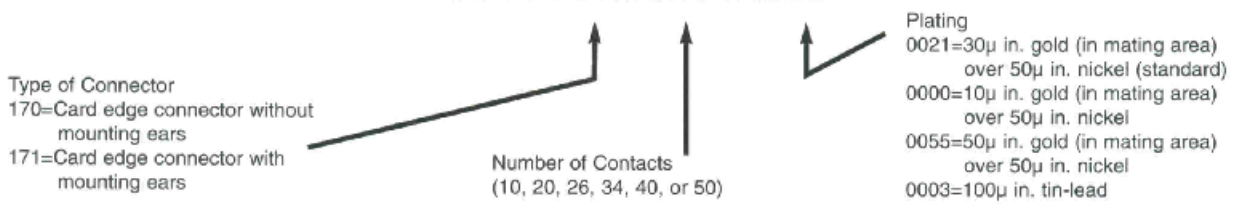

## How to Order Card Edge Cable Assemblies

Cable assemblies with two card edge connectors on a prescribed length of gray flat cable are available with the connectors oriented per drawing 27-1. (#1 contacts oriented to red conductor.)  
 For other lengths, orientations, numbers or combinations of connectors, contact your local value - added distributor.

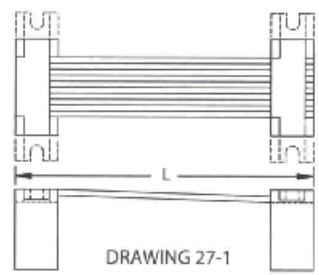

### CA-XX-9X0X

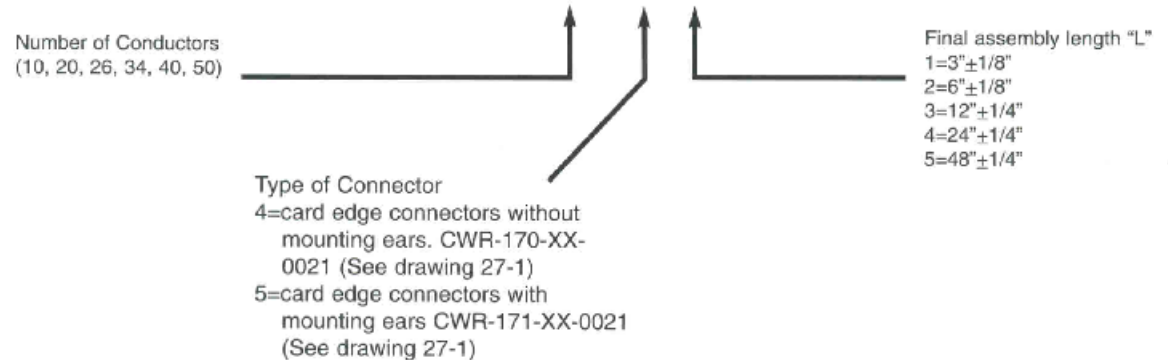

# DIP Connectors

The CW Dual-In-Line Plug (DIP) connector is used for rapid, permanent connection of ribbon cable to a PC board or to a standard DIP socket when connect/disconnect capabilities are required. The cover is factory preassembled to the connector base to simplify assembly to cable and has ridges for cable alignment. CW DIP connectors are Mil-DTL-83503/6 approved.

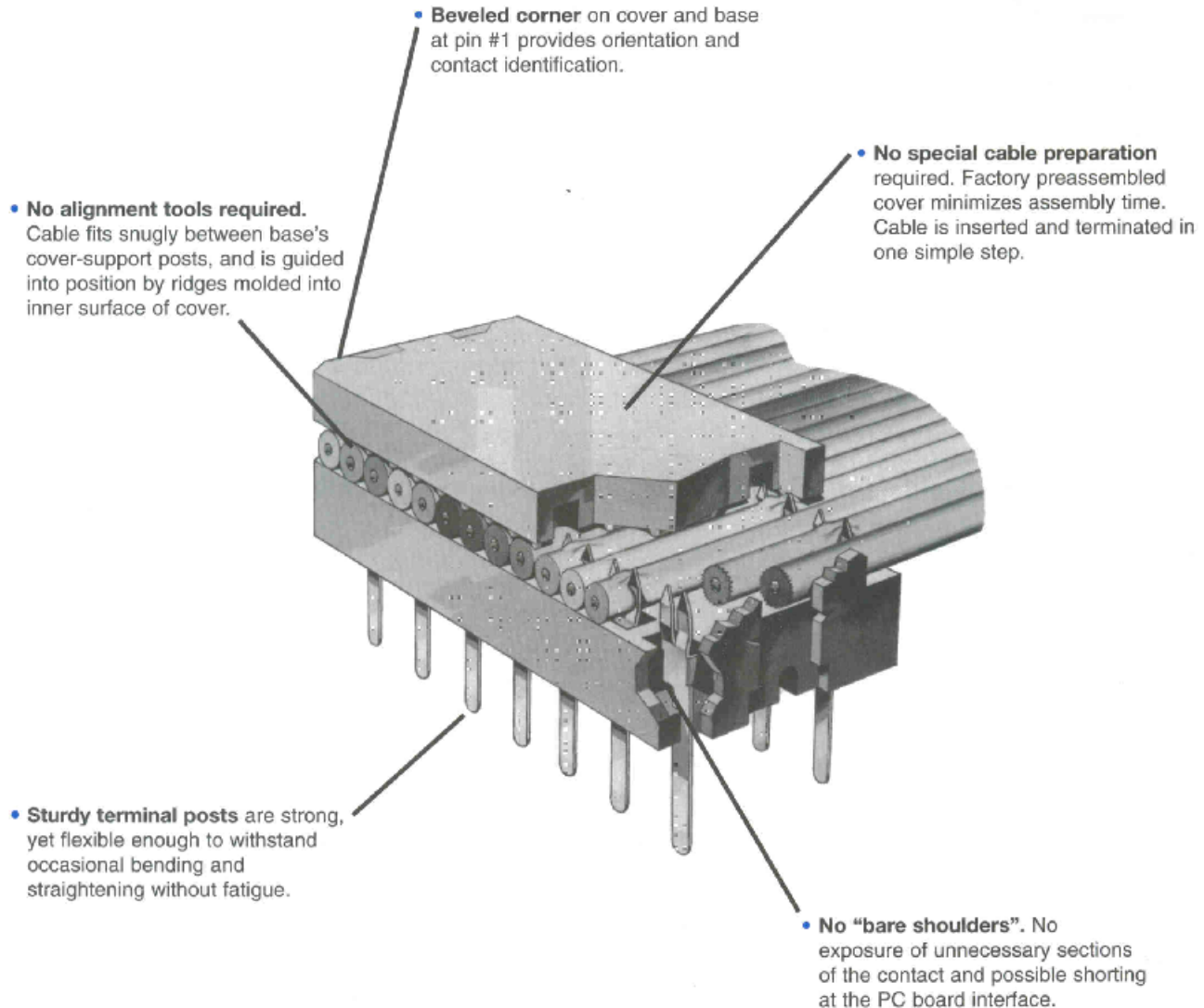



## Contact

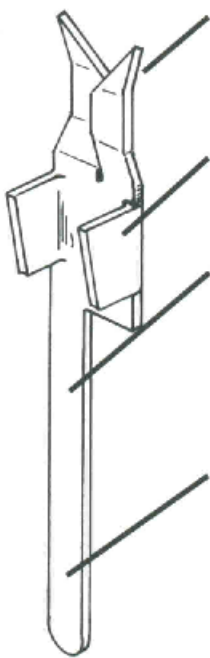

- **Patented offset tines** produce Torq-Tite™ termination for added reliability.
- **Double barbs bite** into plastic, retaining contact firmly in insulator.
- Spring-temper phosphor bronze contact material **resists breakage during bending or straightening operations.**
- **Two tail lengths are available** for use with standard or low profile DIP sockets. .012 in. x .021 in. contact cross-section provides proper mating with a variety of DIP sockets.

## DIP Connector Features

- Mil-DTL-83503/6 approved
- One-piece construction.
- 14, 16, 24, and 40 pin versions.
- Patented Torq-Tite™ contacts, ensure reliable gas-tight terminations.
- Gold-plated phosphor bronze contacts, standard tin-lead plated contacts optional.
- Accepts 28-30 AWG stranded or solid conductors.
- Simple assembly – bench press or low cost hand tool is all that's needed for terminating cable and connectors.
- All pin numbers clearly marked and legible before and after assembly. Numbering is arranged to meet MIL-DTL-83503 specifications for standard IC DIP numbering.
- Optional strain relief clips are easily installed. Allows top center, vertical cable routing to reduce possibility of damage to contact pins during removal of DIP from socket.
- Two contact tail lengths available — .175 in. standard or optional 130 in. length for mating with low profile Dip Sockets.

## Strain Relief

Optional metal strain relief straps are available. Connection is isolated from mechanical strain by the bend in the cable, as it is folded over the top of the assembled connector. The Strain Relief Strap is placed over the cable and snaps into a recess on the connector. A centralized top cable exit is created in the finished cable assembly.

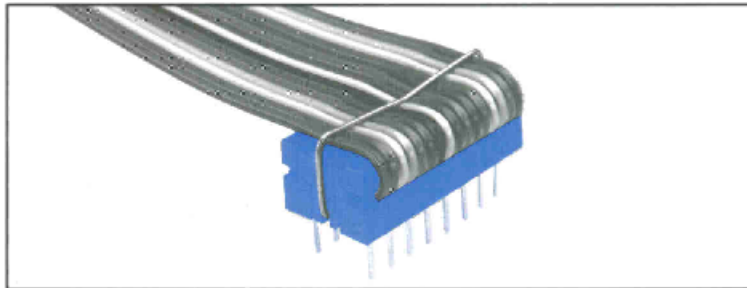

## Contact Identification

Every contact position is numbered, per Mil-DTL-83503, for easy identification. In addition, a beveled corner at pin #1 enhances orientation of the connector to the mating DIP Socket, even in blind installations.

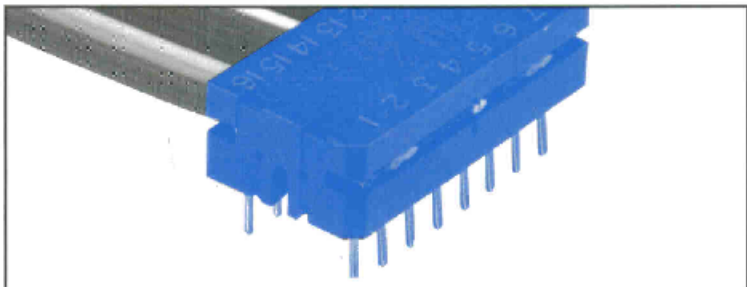

## Assembly

The CT200 DIP Hand Tool is designed to terminate out 14 and 16 pin DIP Connectors. It is easy to use, lightweight and compact, making it an ideal tool for field replacement work or low volume assembly applications. DIP connectors can also be assembled to cable using CW's CT301 76/84 Bench Press.

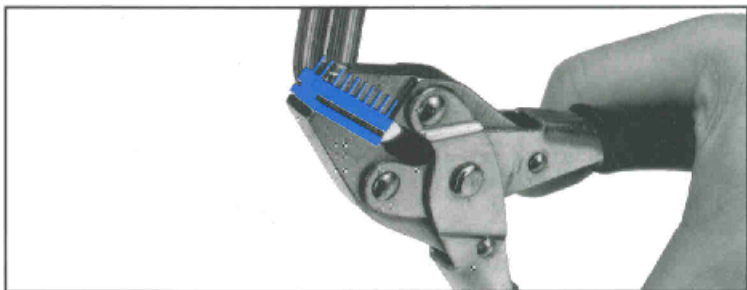

# DIP Connectors

## Engineering Dimensions

### Dimensions

#### 14/16 Pin DIP Connector

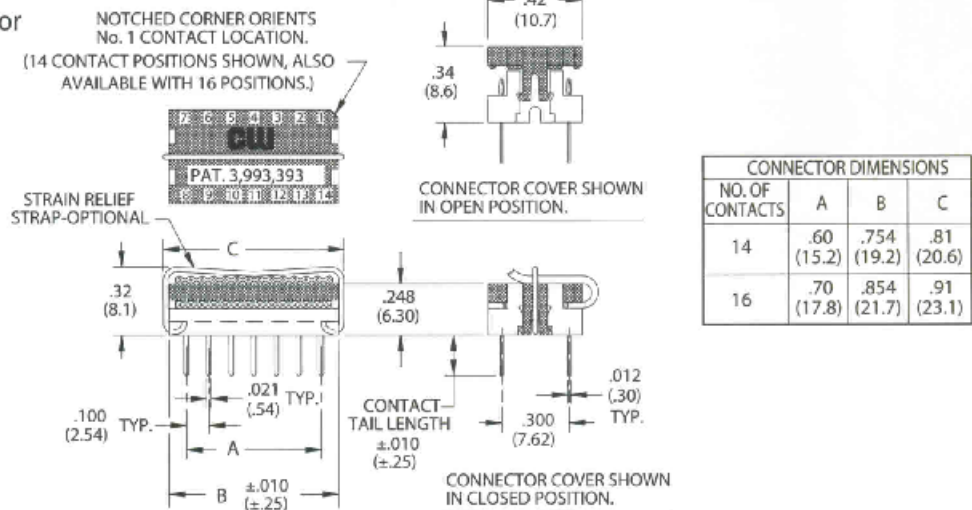

#### 24 Pin DIP Connector

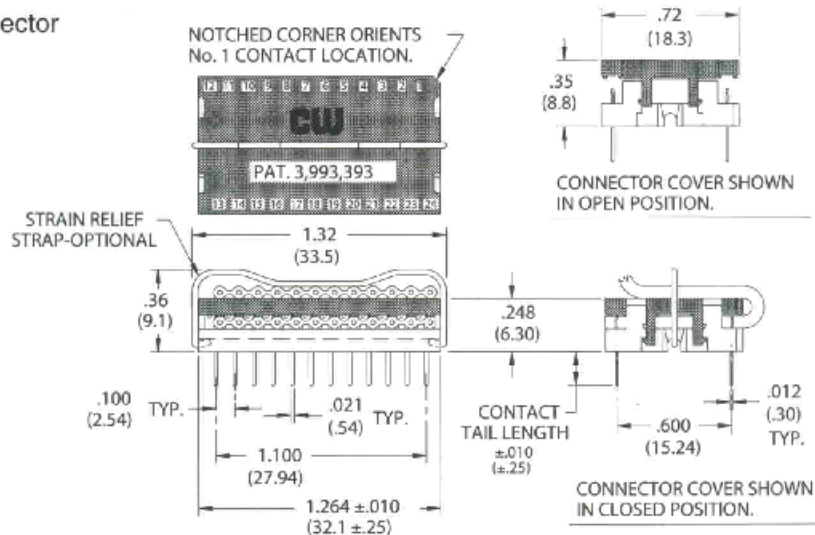

#### 40 Pin DIP Connector

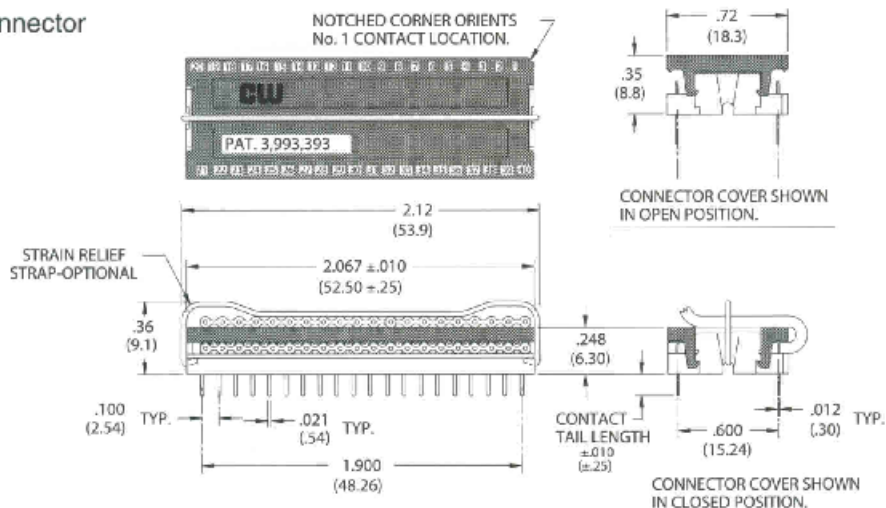

# Specifications and Ordering Information

## Specifications

- Contacts: phosphor bronze standard.
- Contact Plating: 10µ in. gold over 50µ in. nickel, standard; 30µ in. gold over 50µ in. nickel, optional; 50µ in. gold over 50µ in. nickel, optional; 100µ in. tin-lead optional
- Insulator Material: UL 94V-0 flame - retardant glass filled thermoplastic
- Strain Relief Strap Material: tin-plated steel
- Color: blue
- Operating temperature: -55°C to +125°C
- Current Rating: 1A (maximum) per contact
- Dielectric Withstand Voltage: Greater than 500 Vdc at sea level
- Insulation Resistance: Greater than 5 x 10<sup>9</sup> ohms
- Mates with .050 in. centered round conductor flat cable and standard DIP socket with .100 in. x .300 in. or .100 in. x .600 in. contact spacing
- Cover pull off force, with strain relief 20 lb minimum (force along contacts' primary axes)

## How to Order DIP Connectors

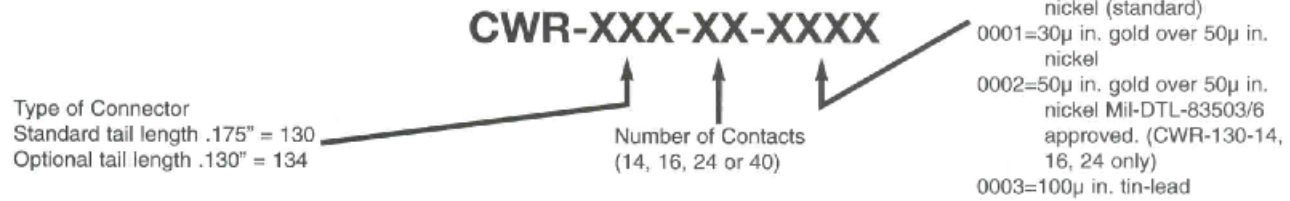

EXAMPLE: CWR-130-16-0002 is part number for a 16-pin DIP connector with .175 in. tails and 50µ in. gold over 50µ in. nickel contacts

## How to Order DIP Cable Assemblies

Cable assemblies with two DIP connectors (CWR-130-XX-0000) on a prescribed length of gray flat cable are available with connectors oriented per drawing 31-1. (#1 contacts oriented to red conductor.)

For other lengths, orientations, numbers or combinations of connectors, contact the factory or your local value-added distributor.

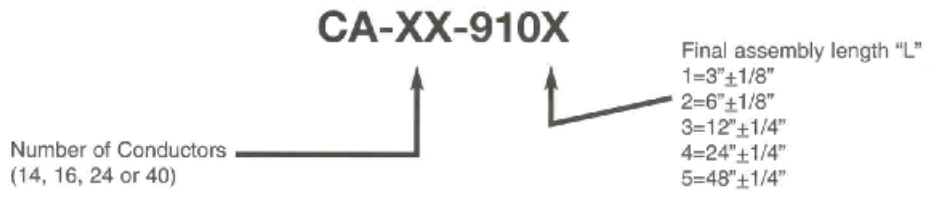
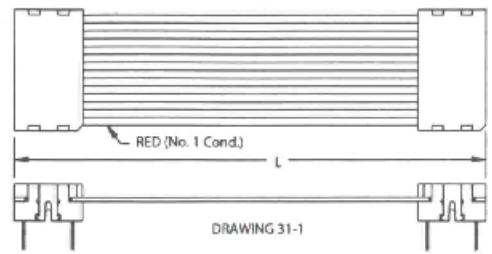

## How to Order Strain Relief Straps for DIP Connectors

EXAMPLE: Strain Relief Strap part number for 24-pin DIP Connector is CWN-SR-24

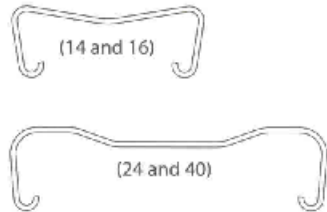

### CWN-SR-XX

Connector Size  
(14, 16, 24 or 40)

# PCB Connectors

The PCB connector is used when a permanent connection of flat cable to the PC board is required. The cable is terminated to the PCB connector making a reliable gas-tight connection with CW's patented Torq-Tite™ contacts. The connector's pins are then soldered to the board.

CW's PCB connectors are approved by the U.S. Defense Department and are qualified to Mil-DTL-83503/23.

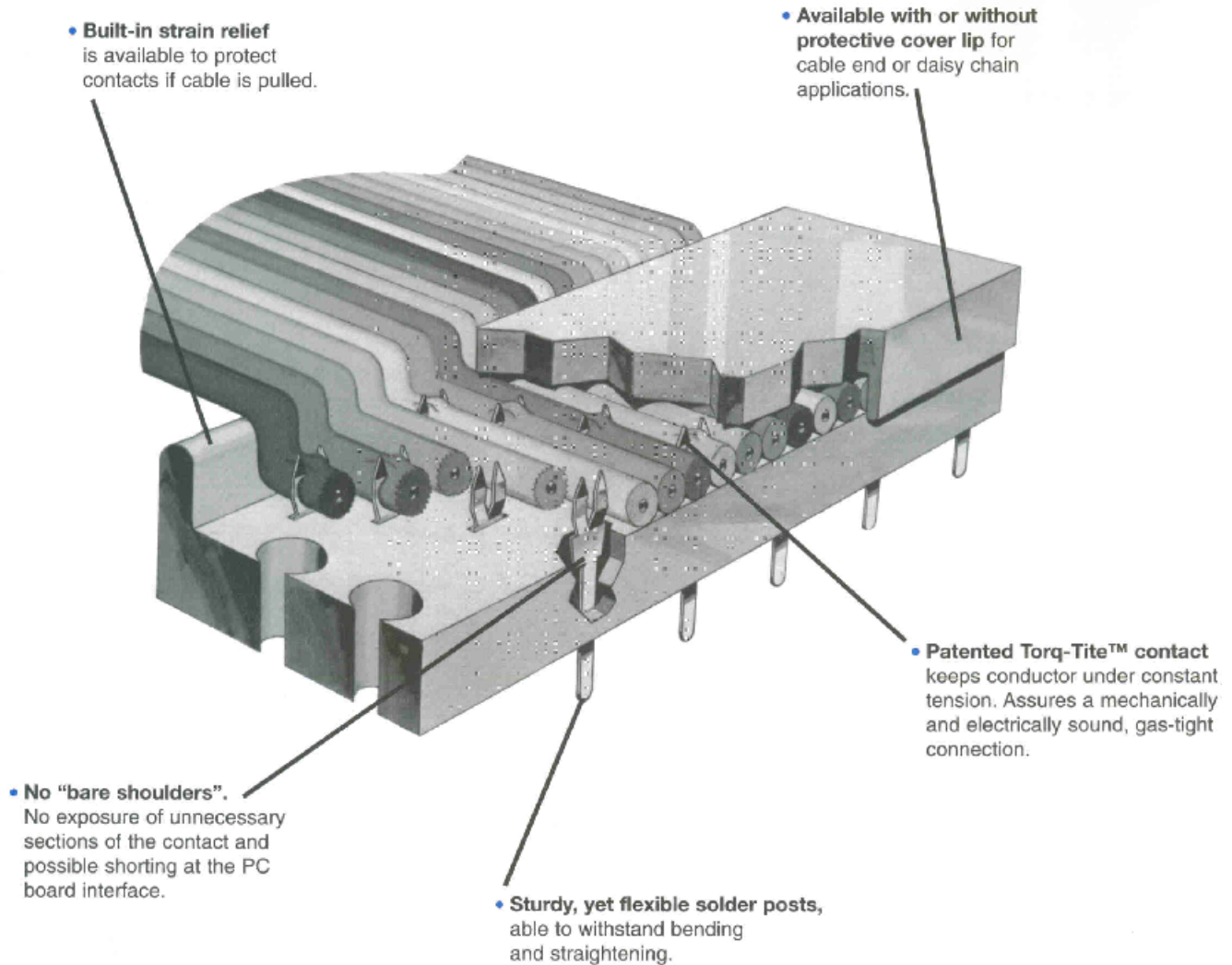

## Contact

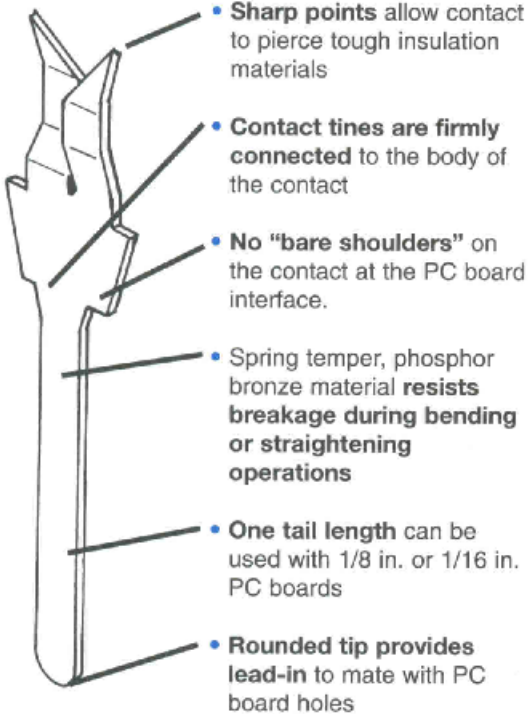

## PCB Connector Features

- 10, 20, 26, 34, 40, 50, 60, pin versions
- Tin-lead plating, standard; gold plating also available
- Available with or without strain relief lip
- Available with or without cover lip for cable end or daisy chain application
- Rugged, lightweight UL 94V-0 thermoplastic construction
- Accepts 28-30 AWG stranded or solid conductors

## Strain Relief

A molded-in strain relief is an optional feature on CW PCB connectors. (Specify CWR-140 or CWR-143 series). This lip, upon installation of the cover, creates a strain relief bend in the cable, inhibiting the transfer of any tension on the cable to the contact lines.

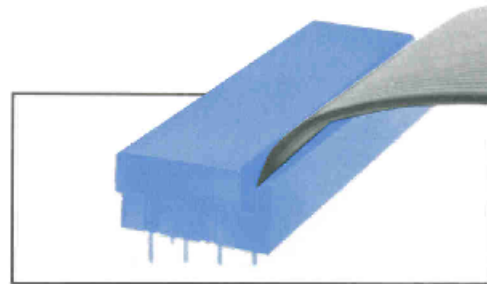

## Cover Lip

For additional protection on cable end terminations, the CW PCB connector is available with a cover lip to insulate the ends of the cable's conductors. This eliminates possible "shorts" and allows you to position connectors more closely on your PC board. (Specify CWR-140 or CWR-141 series).



## Assembly

To terminate CW PCB connectors to flat cable, use CT301 86/81 assembly press. The cable is applied directly to the IDC contacts in the connector base and then the cover is assembled.

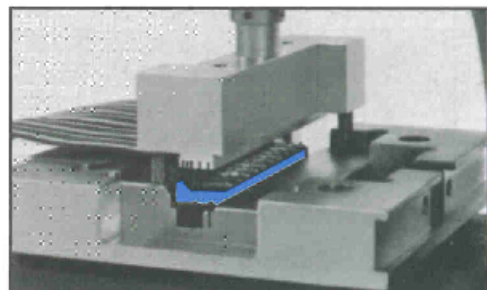
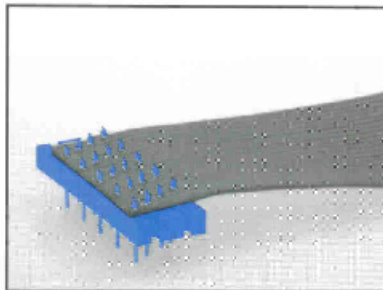

# PCB Connectors

## Engineering Dimensions

### Dimensions

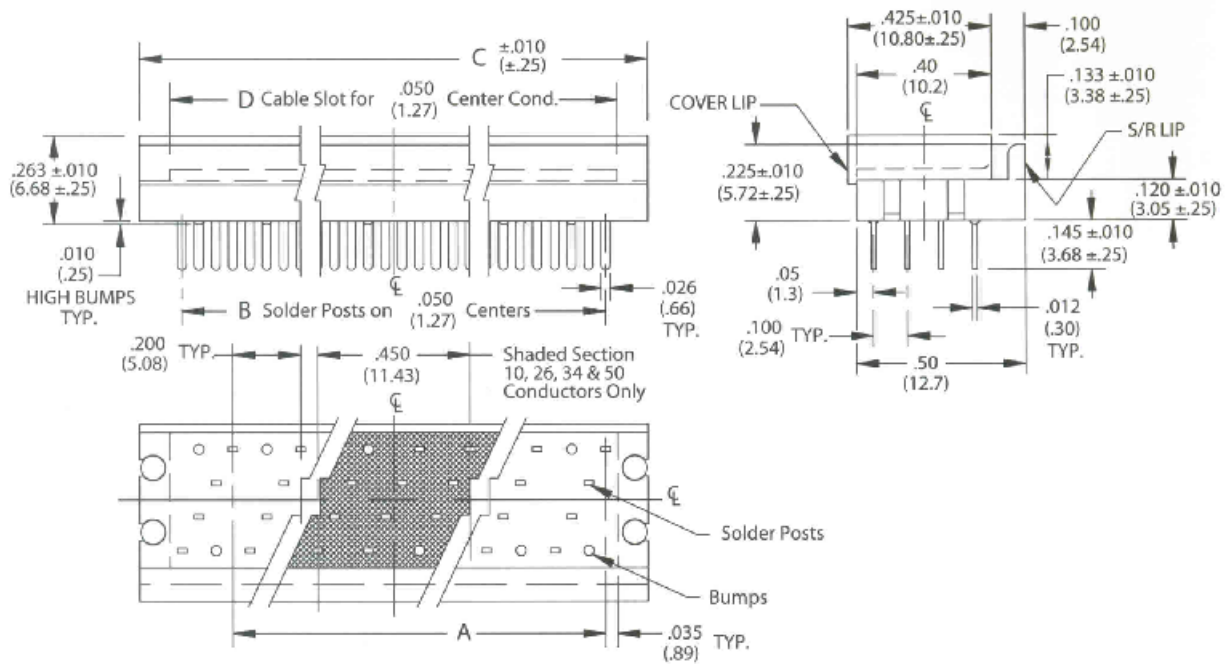

| CONNECTOR DIMENSIONS |                  |                  |                  |                  |
|----------------------|------------------|------------------|------------------|------------------|
| No. Of Contacts      | A                | B                | C                | D                |
| 10                   | —                | .450<br>(11.43)  | .700<br>(17.78)  | .520<br>(13.21)  |
| 20                   | .800<br>(20.32)  | .950<br>(24.13)  | 1.200<br>(30.48) | 1.020<br>(25.91) |
| 26                   | 1.100<br>(27.94) | 1.250<br>(31.75) | 1.500<br>(38.10) | 1.320<br>(33.53) |
| 34                   | 1.500<br>(38.10) | 1.650<br>(41.91) | 1.900<br>(48.26) | 1.720<br>(43.69) |
| 40                   | 1.800<br>(45.72) | 1.950<br>(49.53) | 2.200<br>(55.88) | 2.020<br>(51.31) |
| 50                   | 2.300<br>(58.42) | 2.450<br>(62.23) | 2.700<br>(68.58) | 2.520<br>(64.01) |
| 60                   | 2.800<br>(71.12) | 2.950<br>(74.93) | 3.200<br>(81.28) | 3.020<br>(76.71) |

| Part No. | S/R LIP | COVER LIP |
|----------|---------|-----------|
| CWR-140  | YES     | YES       |
| CWR-141  | NO      | YES       |
| CWR-142  | NO      | NO        |
| CWR-143  | YES     | NO        |

# Specifications and Ordering Information

## Specifications

- Contacts: phosphor bronze standard
- Contact Plating: 100µ in. tin-lead, standard; 10µ in. gold over 50µ in. nickel, optional; 30µ in. gold over 50µ in. nickel, optional; 50µ in. gold over 50µ in. nickel, optional; 200µ in. tin-lead, optional
- Insulator Material: UL 94V-0 flame - retardant thermoplastic
- Color: blue
- Operating temperature: -55°C to +125°C
- Current Rating: 1A (maximum) per contact
- Dielectric Withstand Voltage: greater than 500 Vdc at sea level
- Insulation Resistance: greater than 5 x 10<sup>9</sup> ohms
- Cover pull-off force, without strain relief, 15 lb min. (force along contacts' primary axes)

## How to Order PCB Connectors

### Type of Connector

- 142 = A PCB connector without strain relief for daisy chain termination (standard)
- 140 = A PCB connector with strain relief and cover lip for cable end terminations
- 141 = A PCB connector without strain relief and with cover lip for cable end terminations
- 143 = A PCB connector with strain relief for daisy chain termination

### CWR-XXX-XX-00XX

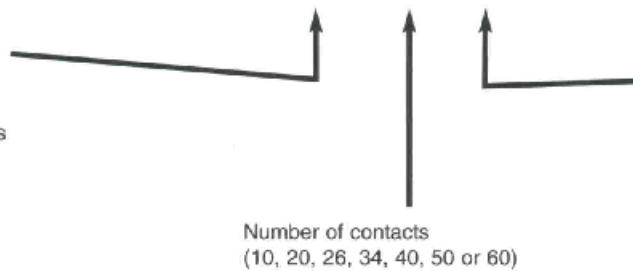

### Plating

- 0003= 100µ in. tin-lead (standard)
- 0000= 10µ in. gold over 50µ in. nickel
- 0001= 30µ in. gold over 50µ in. nickel
- 0047= 50µ in. gold over 50µ in. nickel
- 0042= 100µ in. tin-lead
- Mil-DTL-83503/23 approved (CWR-142-10 through 50 only)

## How to Order PCB Cable Assemblies

Cable assemblies with two PCB Connectors, CWR-142-XX-0003, on a prescribed length of gray flat cable are available with the connectors oriented per drawing 35-1. (#1 contacts oriented to red conductor.) For other lengths, orientations, numbers or combinations of connectors, contact the factory or your local value-added distributor.

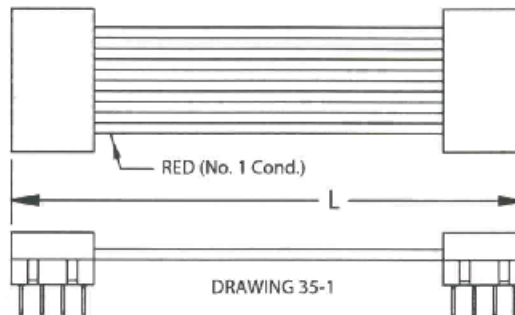

### CA-XX-990X

Number of conductors  
(10, 20, 26, 30, 40, 50, or 60)

### Final assembly length "L"

- 1=3"±1/8"
- 2=6"±1/8"
- 3=12"±1/4"
- 4=24"±1/4"
- 5=48"±1/4"

# Flat Cable

## Flat Cable

The following types of Flat Cable having conductors on .050 in. centers are available from CW Industries:

- Extruded Gray Cable for general use.
- Color-Coded Cable, bonded.
- Jacketed and Shielded Flat Cable for applications where circuitry requires EMI/RFI Shielding and/or protection from mechanical and physical abuse.
- Ground plane cable for high speed signal transmission in computers and electrical equipment.

All CW cables are UL listed, pass the UL VW-1 flame test, and mate with insulation displacement connectors on .050 in. centers.

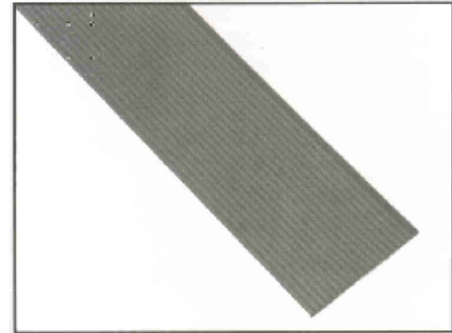

## Extruded Gray Cable – 105°C PVC

CW's gray flat cable is designed for basic, general purpose applications. It combines low cost with consistently reliable performance. Mirror image profile permits reverse plane termination on the same cable length. Flexibility and excellent teardown characteristics allow intricate circuit routing and uniform breakouts for harness production.

### Description

- 28 AWG (7/36) stranded tinned copper conductor
- Nominal Insulation Thickness: .010in (.25 mm) PVC
- Conductors on .050 in. (1.27 mm) centers
- Gray PVC with red stripe on leading edge
- UL listed – Style 2651
- Passes UL VW-1

### Characteristics

- Temperature Rating: 105°C
- Voltage Rating: 300 Volts
- Capacitance: 14 pF/ft nom.\*
- Propagation Delay: 1.4 ns/ft (nom.)
- Impedance: 105 ohms nom.\*
- Crosstalk: nom. between two adjacent single lines @ 1 ns rise time over 10 ft (3.05 M) length; near end 3.2% –far end 11.5%\*

### Special Constructions

- 30 AWG solid, tinned copper conductors available.
- Tin overcoated, stranded conductor available.

\*Transmission Characteristics:  
Ground-signal-ground-signal, etc. with all grounds common.

| CW P/N      | No. of Conductors | Nominal Overall Width (W) |         | Nominal Span (S) |         |
|-------------|-------------------|---------------------------|---------|------------------|---------|
|             |                   | Inches                    | (mm)    | Inches           | (mm)    |
| C-03-000-9  | 9                 | .45                       | (11.43) | .40              | (10.16) |
| C-03-000-10 | 10                | .50                       | (12.70) | .45              | (11.43) |
| C-03-000-14 | 14                | .70                       | (17.78) | .65              | (16.51) |
| C-03-000-15 | 15                | .75                       | (19.05) | .70              | (17.78) |
| C-03-000-16 | 16                | .80                       | (20.32) | .75              | (19.05) |
| C-03-000-20 | 20                | 1.00                      | (25.40) | .95              | (24.13) |
| C-03-000-24 | 24                | 1.20                      | (30.48) | 1.15             | (29.21) |
| C-03-000-25 | 25                | 1.25                      | (31.75) | 1.20             | (30.48) |
| C-03-000-26 | 26                | 1.30                      | (33.02) | 1.25             | (31.75) |
| C-03-000-34 | 34                | 1.70                      | (43.18) | 1.65             | (41.91) |
| C-03-000-37 | 37                | 1.85                      | (46.99) | 1.80             | (45.72) |
| C-03-000-40 | 40                | 2.00                      | (50.80) | 1.95             | (49.53) |
| C-03-000-50 | 50                | 2.50                      | (63.50) | 2.45             | (62.23) |
| C-03-000-60 | 60                | 3.00                      | (76.20) | 2.95             | (74.93) |

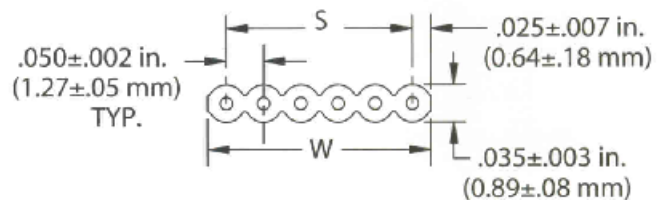



## Color-Coded Cable

CW's Color-Coded Cable is manufactured from pre-insulated color-coded conductors which are then bonded on .050 in. center to center spacing. This permits conventional termination using insulation displacement connectors. Color coding affords immediate identification of discrete wires for positive termination and traceability.

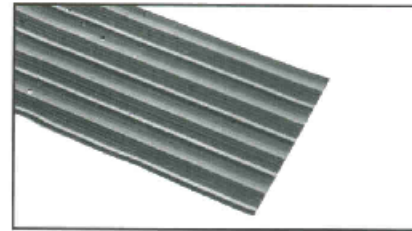

### Description

- 28 AWG (7/36) stranded tinned copper conductor
- Color Code: brown, red, orange, yellow, green, blue, violet, gray, white, black. Color code repeats beyond 10 conductors.
- UL listed—Style 2693
- Passes UL VW-1

### Characteristics

- Temperature Rating: 105°C
- Voltage Rating: 300 Volts
- Capacitance: 15 pF/ft nom.
- Propagation Delay: 1.4 ns/ft (nom.)
- Impedance: 100 ohms nom.\*

**Bonded** UL Style 20029

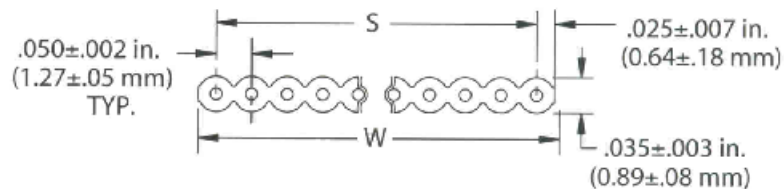

| Bonded P/N  | No. of Conductors | Nominal Overall Width (W) |         | Nominal Span (S) |         |
|-------------|-------------------|---------------------------|---------|------------------|---------|
|             |                   | Inches                    | (mm)    | Inches           | (mm)    |
| C-03-006-9  | 9                 | .45                       | (11.43) | .40              | (10.16) |
| C-03-006-10 | 10                | .50                       | (12.70) | .45              | (11.43) |
| C-03-006-14 | 14                | .70                       | (17.78) | .65              | (16.51) |
| C-03-006-15 | 15                | .75                       | (19.05) | .70              | (17.78) |
| C-03-006-16 | 16                | .80                       | (20.32) | .75              | (19.05) |
| C-03-006-20 | 20                | 1.00                      | (25.40) | .95              | (24.13) |
| C-03-006-24 | 24                | 1.20                      | (30.48) | 1.15             | (29.21) |
| C-03-006-25 | 25                | 1.25                      | (31.75) | 1.20             | (30.48) |
| C-03-006-26 | 26                | 1.30                      | (33.02) | 1.25             | (31.75) |
| C-03-006-34 | 34                | 1.70                      | (43.18) | 1.65             | (41.91) |
| C-03-006-37 | 37                | 1.85                      | (46.99) | 1.80             | (45.72) |
| C-03-006-40 | 40                | 2.00                      | (50.80) | 1.95             | (49.53) |
| C-03-006-50 | 50                | 2.50                      | (63.50) | 2.45             | (62.23) |
| C-03-006-60 | 60                | 3.00                      | (76.20) | 2.95             | (74.93) |

### Special Constructions

- Tin overcoated stranded conductor, available.
- Other color combinations available.
- CSA listed cable available.
- Intermittent Bond Cable available.

\*Transmission Characteristics: Ground-signal-ground-signal, etc. with all grounds common.

# Assembly Tools

## Complete Assembly Press Kit

The CT304 Assembly Press Kit consists of a rugged, yet lightweight, cast aluminum frame and a variety of interchangeable upper and lower dies, each specifically designed to provide high-speed termination of one or more types of CW IDC connectors. The interchangeable lower and upper dies can be aligned in either of two perpendicular directions for cable end or daisy chain applications. An adjustable cable guide aligns the cable squarely in the connector with the dies in either position. The handle of the assembly press provides a mechanical advantage of 25:1 to minimize operator fatigue. The handle's travel can be adjusted to accommodate varying connectors and assembly operations by raising or lowering the upper die holding screw—one full turn equals a .050 in., vertical height adjustment. Also, a spring-loaded plunger allows the handle to rest in any convenient position—at mid stroke, either end, or anywhere in between.

The CT304 Assembly Press Kit includes a CT301 press and the six dies listed in the chart at the right. All CW connectors shown in this catalog, as well as many made by other manufacturers, can be terminated to flat cable having conductors on .050 in. centers using this equipment.

## Assembly Press & Dies

Each part of the assembly press kit can be ordered individually. The CT301 includes only the press, the nest to hold any of the lower assembly dies, a cable guide and an upper die holding screw which will accept any of our standard upper dies. The specific upper and lower dies required for a particular assembly operation can be ordered from the chart at the right.

To designate the CT301 press with a specific combination of upper and lower dies, such as CT 34-76 and CT 34-84, call out CT301-76/84.

For detailed assembly instructions, contact the factory or your local CW Value-Added Distributor.



| Connector   | Upper Die Required | Lower Die Required |
|---|--------------------|--------------------|
| CWR-130/134 DIP                                       | CT-34-76           | CT-34-84           |
| CWR-170/171 CARD EDGE                                 | CT-34-76           | CT-34-89           |
| CWR-180/181/182/183/280/281/282/283<br>D-SUBMINIATURE | CT-34-76           | CT-34-89           |
| CWR-210/217/220/227 SOCKET                            | CT-34-76           | CT-34-80           |
| CWR-140/141/142/143 PCB                               | CT-34-76           | CF-150             |

To prepare shielded and jacketed cable for use with CW's metal-faced D-subminiature and EMI/RFI shield, specify the CT-34-33 tool in the 9, 15, 25 or 37 conductor size.

For information describing automatic connector assembly equipment, please contact the factory.

## DIP Hand Tool

The CT200 DIP Hand Tool is designed to terminate CW 14 and 16 pin DIP connectors and is ideal for field repair or replacement. It is also adapted for use in assembling CWN-HK-05 and -06 hardware kits to D-Subminiatures connectors.

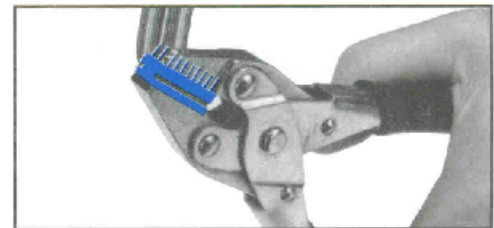

## Header Rib Removal Tool

CT-34-32 R-R Finishing Tool allows you to readily remove header polarizing ribs whenever polarization is not required. Simply slip the tool over one of the ribs in the header and rotate it 150°. The CT-34-32 tool can also be used to assemble the retaining ring in hardware kits CWN-HK-01 and CWN-HK-03 to a D-Subminiature connector.

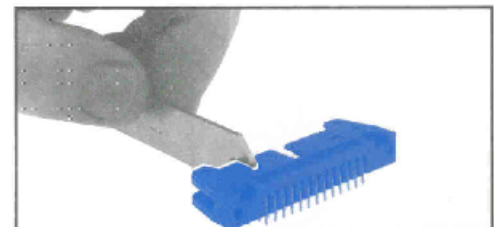

# Significance of Mil-DTL-83503 and Mil-DTL-24308 Approvals

Procurement agencies of the United States government purchase vast quantities and types of electrical and electronic military gear for use by The Department of Defense and its many branches. Because of the obvious need for reliability of military equipment, specifications have been developed to define minimum acceptable performance standards for components used in this equipment. Those components that meet the performance standards and physical parameters defined in these specifications are placed on a Government prepared "Qualified Products List" (QPL); and they remain on this list provided ongoing and continuing "acceptance" tests indicate that the product continues to meet the specification requirements.

The Qualified Products List for Mil-DTL-83503 (the general specification for multi-contact, electrical connectors for terminating flexible flat cable) is established and maintained by the Defense Electronics Supply Center, Dayton, Ohio as agent for the Air Force Acquisition Logistics Division (AFALD-PTS) Gentile Air Force Station, Ohio.

CW has been involved with Mil-DTL-83503 from the outset. Our engineers helped the Department of Defense establish the standards and our IDCs were among the first placed on the QPL.

Our government-certified testing facilities constantly evaluate production connectors in keeping with Mil-DTL-83503.

Mil-DTL-83503 establishes the physical, material, and performance standards for IDCs purchased for military use. These include physical dimensions, materials of construction, and performance standards—high and low temperature, thermal and mechanical shock, dielectric withstanding voltage, cable retention, contact retention, cable flexing, contact resistance, mating and unmating forces, durability, and others. The specifications also describe test methods used to determine component acceptability for each of these standards.

Standardization of IDCs has been promoted and supported by the requirements of Mil-DTL-83503. This specification has proven useful, not only by tending to increase the performance levels that IDC manufacturers strive to achieve, but by setting up general criteria that lead to predictable performance and interchangeability among various IDC types from various sources.

CW's position of leadership in the industry is a direct result of our leading role in the development of these standards.

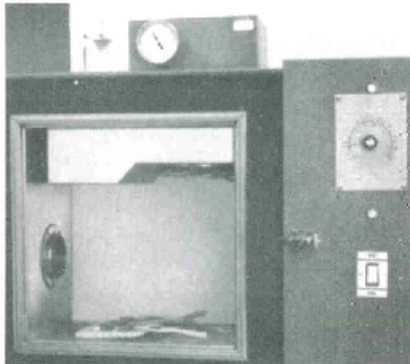

Temperature cycling from hot to cold

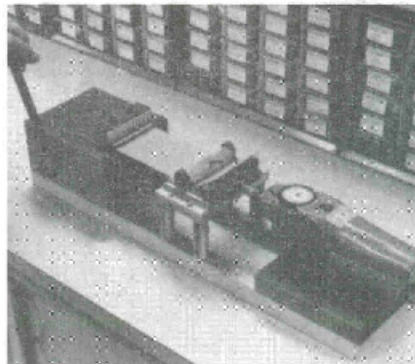

Test to determine the force for cover pull-off from base of connector

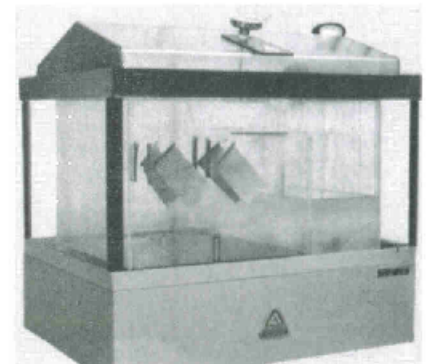

Exposure to a hostile salt spray environment

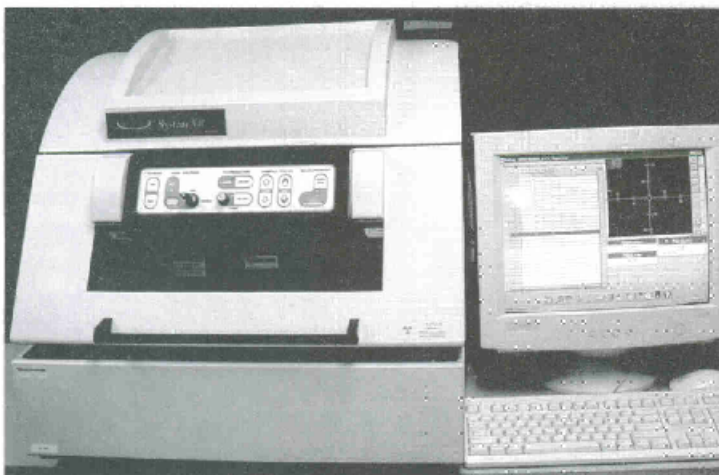

X-Ray Fluorescence Equipment is used to determine the precise thickness of Contact Plating

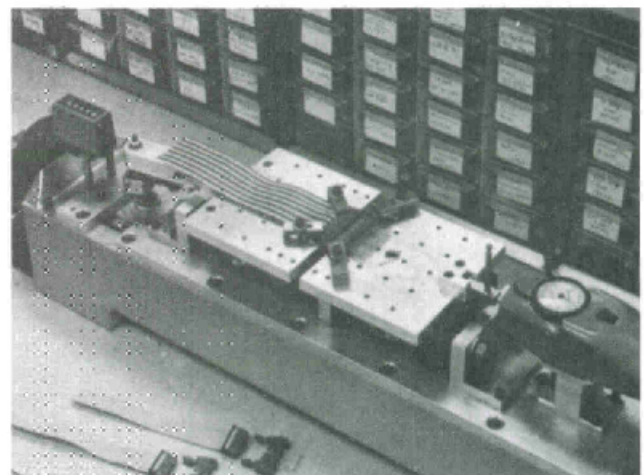

Measurements of insertion and withdrawal forces after 500 matings

# Part Number Index

| Connectors  |                | Connectors  |                | Connectors  |         |
|-------------|----------------|-------------|----------------|-------------|---------|
| Part Number | Page(s)        | Part Number | Page(s)        | Part Number | Page(s) |
| CWN-290     | 22-25          | CWN-502     | 10, 11, 14, 15 | CWR-170     | 26-29   |
| CWN-292     | 22-25          | CWN-510     | 10, 11, 14, 15 | CWR-171     | 26-29   |
| CWN-300     | 10-13          | CWN-511     | 10, 11, 14, 15 | CWR-180     | 18-21   |
| CWN-301     | 10-13          | CWN-512     | 10, 11, 14, 15 | CWR-181     | 18-21   |
| CWN-302     | 10-13          | CWN-520     | 10, 11, 14, 15 | CWR-182     | 18-21   |
| CWN-310     | 10-13          | CWN-521     | 10, 11, 14, 15 | CWR-183     | 18-21   |
| CWN-311     | 10-13          | CWN-522     | 10, 11, 14, 15 | CWR-210     | 6-9     |
| CWN-312     | 10-13          | CWN-530     | 10, 11, 14, 17 | CWR-217     | 6-9     |
| CWN-320     | 10-13          | CWN-531     | 10, 11, 14, 17 | CWR-220     | 6-9     |
| CWN-321     | 10-13          | CWN-535     | 10, 11, 14, 17 | CWR-227     | 6-9     |
| CWN-322     | 10-13          | CWN-536     | 10, 11, 14, 17 | CWR-280     | 22-25   |
| CWN-330     | 4, 10, 16, 17  | CWN-538     | 10, 11, 14, 17 | CWR-281     | 22-25   |
| CWN-331     | 10, 11, 16, 17 | CWN-550     | 10, 11, 14, 15 | CWR-282     | 22-25   |
| CWN-335     | 10, 11, 16, 17 | CWN-551     | 10, 11, 14, 15 | CWR-283     | 22-25   |
| CWN-336     | 10, 11, 16, 17 | CWN-552     | 10, 11, 14, 15 |             |         |
| CWN-338     | 10, 11, 16, 17 | CWN-560     | 10, 11, 14, 15 |             |         |
| CWN-350     | 10-13          | CWN-561     | 10, 11, 14, 15 |             |         |
| CWN-351     | 10-13          | CWN-562     | 10, 11, 14, 15 |             |         |
| CWN-352     | 10-13          | CWN-570     | 10, 11, 14, 15 |             |         |
| CWN-360     | 10-13          | CWN-571     | 10, 11, 14, 15 |             |         |
| CWN-361     | 10-13          | CWN-572     | 10, 11, 14, 15 |             |         |
| CWN-362     | 10-13          | CWN-600     | 10, 11, 14, 15 |             |         |
| CWN-370     | 10-13          | CWN-601     | 10, 11, 14, 15 |             |         |
| CWN-371     | 10-13          | CWN-602     | 10, 11, 14, 15 |             |         |
| CWN-372     | 10-13          | CWN-610     | 10, 11, 14, 15 |             |         |
| CWN-400     | 10-13          | CWN-611     | 10, 11, 14, 15 |             |         |
| CWN-401     | 10-13          | CWN-612     | 10, 11, 14, 15 |             |         |
| CWN-402     | 10-13          | CWN-620     | 10, 11, 14, 15 |             |         |
| CWN-410     | 10-13          | CWN-621     | 10, 11, 14, 15 |             |         |
| CWN-411     | 10-13          | CWN-622     | 10, 11, 14, 15 |             |         |
| CWN-412     | 10-13          | CWN-630     | 10, 11, 16, 17 |             |         |
| CWN-420     | 10-13          | CWN-631     | 10, 11, 16, 17 |             |         |
| CWN-421     | 10-13          | CWN-635     | 10, 11, 16, 17 |             |         |
| CWN-422     | 10-13          | CWN-636     | 10, 11, 16, 17 |             |         |
| CWN-430     | 10, 11, 16, 17 | CWN-638     | 10, 11, 16, 17 |             |         |
| CWN-431     | 10, 11, 16, 17 | CWN-650     | 10, 11, 14, 15 |             |         |
| CWN-435     | 10, 11, 16, 17 | CWN-651     | 10, 11, 14, 15 |             |         |
| CWN-436     | 10, 11, 16, 17 | CWN-652     | 10, 11, 14, 15 |             |         |
| CWN-438     | 10, 11, 16, 17 | CWN-660     | 10, 11, 14, 15 |             |         |
| CWN-450     | 10-13          | CWN-661     | 10, 11, 14, 15 |             |         |
| CWN-451     | 10-13          | CWN-662     | 10, 11, 14, 15 |             |         |
| CWN-452     | 10-13          | CWN-670     | 10, 11, 14, 15 |             |         |
| CWN-460     | 10-13          | CWN-671     | 10, 11, 14, 15 |             |         |
| CWN-461     | 10-13          | CWN-672     | 10, 11, 14, 15 |             |         |
| CWN-462     | 10-13          | CWR-130     | 30-33          |             |         |
| CWN-470     | 10-13          | CWR-134     | 30-33          |             |         |
| CWN-471     | 10-13          | CWR-140     | 34-37          |             |         |
| CWN-472     | 10-13          | CWR-141     | 34-37          |             |         |
| CWN-500     | 10, 11, 14, 15 | CWN-142     | 34-37          |             |         |
| CWN-501     | 10, 11, 14, 15 | CWR-143     | 34-37          |             |         |

| Cable    |    |
|----------|----|
| C-03-000 | 38 |
| C-03-006 | 39 |

| Cable Assemblies |    |
|------------------|----|
| CA-XX-910X       | 33 |
| CA-XX-920X       | 9  |
| CA-XX-930X       | 9  |
| CA-XX-940X       | 29 |
| CA-XX-950X       | 29 |
| CA-XX-960X       | 21 |
| CA-XX-970X       | 21 |
| CA-XX-980X       | 21 |
| CA-XX-990X       | 37 |

| Accessories     |        |
|-----------------|--------|
| CWN-HK-01 to 06 | 20     |
| CWN-HK-07 to 12 | 25     |
| CWN-KEY 1       | 7, 8   |
| CWN-KEY 2       | 27, 28 |
| CWN-SR-XX       | 31-33  |

| Assembly Tools |    |
|----------------|----|
| CT-34-XX       | 40 |
| CT-34-33-XX    | 40 |
| CT-200         | 40 |
| CT-301         | 40 |
| CT-304         | 40 |





# Other **CW INDUSTRIES** Products

---

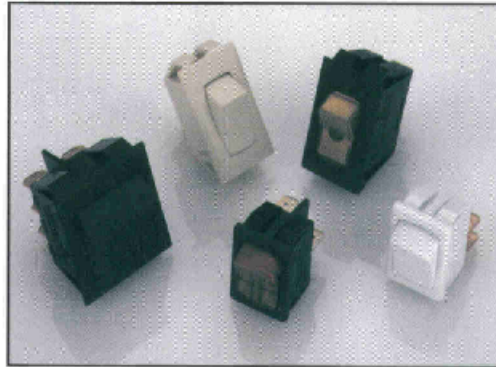

## **CW ROCKER & POWER SLIDE SWITCHES CATALOG**

From miniature to standard full-sized switches, CW offers a comprehensive line of high-quality, attractively styled and very competitively priced rocker and power slide switches. We offer switches rated to 16A @ 125/250 Vac in circuitries ranging from SPST through DPDT, including center-off, spring-return, and illuminated versions. A variety of color, marking, and termination options are available. Our patented unique contact sliding and rotating action ensures contact cleanliness and extended life.

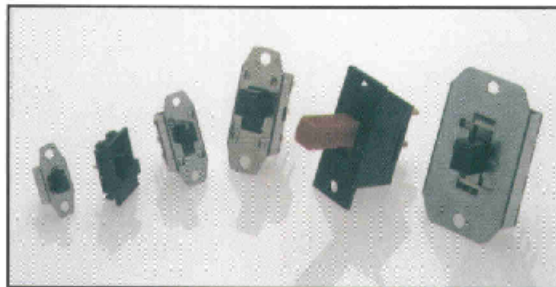

## **CW SLIDE SWITCH CATALOG**

From micro-miniature, to miniature, and standard-sized slide switches, CW offers the most comprehensive line of slide switches for panel or PC board mounting. A wide variety of circuitry options is available ranging from one through four poles and one through five positions. Switches are available in .5 to 16A @ 125 Vac – including top, side, and end actuated designs. Custom cap and superstructure options make CW slide switches extremely versatile and attractive.

**For More Information, Contact:**

**CW INDUSTRIES**

130 James Way • Southampton, PA 18966 - 3838

Telephone: (215) 355-7080 • Fax: (215) 355-1088

[www.cwind.com](http://www.cwind.com)







Компания «ЭлектроПласт» предлагает заключение долгосрочных отношений при поставках импортных электронных компонентов на взаимовыгодных условиях!

Наши преимущества:

- Оперативные поставки широкого спектра электронных компонентов отечественного и импортного производства напрямую от производителей и с крупнейших мировых складов;
- Поставка более 17-ти миллионов наименований электронных компонентов;
- Поставка сложных, дефицитных, либо снятых с производства позиций;
- Оперативные сроки поставки под заказ (от 5 рабочих дней);
- Экспресс доставка в любую точку России;
- Техническая поддержка проекта, помощь в подборе аналогов, поставка прототипов;
- Система менеджмента качества сертифицирована по Международному стандарту ISO 9001;
- Лицензия ФСБ на осуществление работ с использованием сведений, составляющих государственную тайну;
- Поставка специализированных компонентов (Xilinx, Altera, Analog Devices, Intersil, Interpoint, Microsemi, Aeroflex, Peregrine, Syfer, Eurofarad, Texas Instrument, Miteq, Cobham, E2V, MA-COM, Hittite, Mini-Circuits, General Dynamics и др.);

Помимо этого, одним из направлений компании «ЭлектроПласт» является направление «Источники питания». Мы предлагаем Вам помощь Конструкторского отдела:

- Подбор оптимального решения, техническое обоснование при выборе компонента;
- Подбор аналогов;
- Консультации по применению компонента;
- Поставка образцов и прототипов;
- Техническая поддержка проекта;
- Защита от снятия компонента с производства.



#### Как с нами связаться

**Телефон:** 8 (812) 309 58 32 (многоканальный)

**Факс:** 8 (812) 320-02-42

**Электронная почта:** [org@eplast1.ru](mailto:org@eplast1.ru)

**Адрес:** 198099, г. Санкт-Петербург, ул. Калинина, дом 2, корпус 4, литера А.