

## Overview

The A70 Series is constructed of metallized polypropylene film with axial leads of tinned wire. The axial leads are electrically welded to the metal layer on the ends of the capacitor winding. The capacitor is encapsulated in a polyester tape wrapping case with thermosetting resin material.

## Applications

Typical applications include temperature compensation circuits, timing, oscillator circuits, power factor correction, and coupling capacitors in switched mode power supply (SMPS) applications. Not suitable for across-the-line application (see Suppressor Capacitors).

## Benefits

- Voltage range: 160 – 630 VDC
- Capacitance range: 0.001  $\mu$ F – 4.7  $\mu$ F
- Diameter: 5 – 21.5 mm
- Length: 11 – 33 mm
- Capacitance tolerance:  $\pm$ 5%,  $\pm$ 10%,  $\pm$ 20%
- Climatic category: 55/105/56 IEC 60068-1
- Operating temperature range of  $-55^{\circ}\text{C}$  to  $+105^{\circ}\text{C}$
- RoHS compliance and lead-free terminations
- Tape & Reel packaging in accordance with IEC 60286-1
- Self-healing

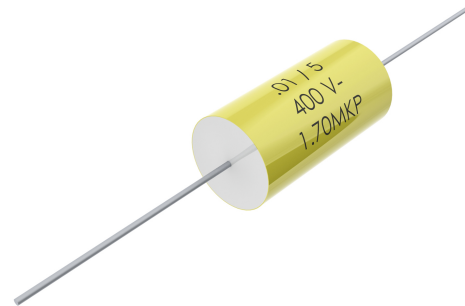

## Part Number System

A70	G	F	2220	AA	00	J
Series	Rated Voltage (VDC)	Length (mm)	Capacitance Code (pF)	Lead and Packaging Code	Internal Use	Capacitance Tolerance
Metallized Polypropylene	G = 160 I = 250 M = 400 P = 630	F = 11 H = 14 K = 20.5 Q = 28 T = 33	The last three digits represent significant figures. The first digit specifies the total number of zeros to be added.	See Ordering Options Table	00 (Standard)	J = $\pm$ 5% K = $\pm$ 10% M = $\pm$ 20%

## Ordering Options Table

Type of Leads and Packaging	Lead Length (mm)	Lead and Packaging Code
Bulk (Bag) – Short Leads	40 ±5	AA
Tape & Reel (Standard Reel Ø 355 mm)	H <sub>0</sub> =18.5 ±0.5	26

## Dimensions – Millimeters

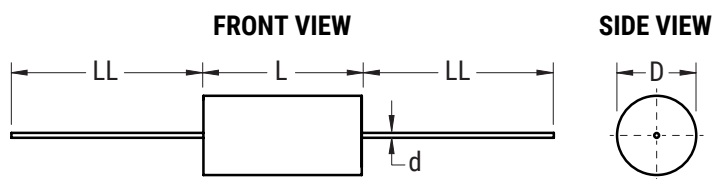

D		L		d	
Nominal	Tolerance	Nominal	Tolerance	Nominal	Tolerance
5.0	Maximum	11.0	Maximum	0.5	±0.05
5.5	Maximum	14.0	Maximum	0.6	±0.05
6.0	Maximum	14.0	Maximum	0.6	±0.05
6.5	Maximum	14.0	Maximum	0.6	±0.05
7.0	Maximum	14.0	Maximum	0.8	±0.05
7.0	Maximum	20.5	Maximum	0.8	±0.05
7.5	Maximum	14.0	Maximum	0.8	±0.05
7.5	Maximum	20.5	Maximum	0.8	±0.05
8.0	Maximum	20.5	Maximum	0.8	±0.05
8.0	Maximum	28.0	Maximum	0.8	±0.05
8.5	Maximum	14.0	Maximum	0.8	±0.05
8.5	Maximum	20.5	Maximum	0.8	±0.05
8.5	Maximum	28.0	Maximum	0.8	±0.05
9.0	Maximum	20.5	Maximum	0.8	±0.05
9.5	Maximum	28.0	Maximum	0.8	±0.05
10.0	Maximum	28.0	Maximum	0.8	±0.05
<b>Note: See Ordering Options Table for lead length (LL / l) options.</b>					

D		L		d	
Nominal	Tolerance	Nominal	Tolerance	Nominal	Tolerance
11.0	Maximum	28.0	Maximum	0.8	±0.05
11.5	Maximum	28.0	Maximum	0.8	±0.05
12.0	Maximum	33.0	Maximum	0.8	±0.05
12.5	Maximum	33.0	Maximum	0.8	±0.05
13.0	Maximum	28.0	Maximum	0.8	±0.05
13.5	Maximum	33.0	Maximum	0.8	±0.05
14.5	Maximum	33.0	Maximum	0.8	±0.05
15.0	Maximum	33.0	Maximum	0.8	±0.05
16.5	Maximum	33.0	Maximum	1.0	±0.05
17.0	Maximum	33.0	Maximum	1.0	±0.05
17.5	Maximum	33.0	Maximum	1.0	±0.05
18.0	Maximum	33.0	Maximum	1.0	±0.05
20.0	Maximum	33.0	Maximum	1.0	±0.05
21.0	Maximum	33.0	Maximum	1.0	±0.05
21.5	Maximum	33.0	Maximum	1.0	±0.05
<b>Note: See Ordering Options Table for lead length (LL / l) options.</b>					

## Performance Characteristics

Dielectric	Polypropylene film			
Plates	Metal layer deposited by evaporation under vacuum			
Winding	Non-inductive type			
Leads	Tinned wire			
Protection	Plastic case, thermosetting resin filled. Box material is solvent resistant and flame retardant according to UL94.			
Related Documents	IEC 60384-16			
Rated Voltage $V_R$ (VDC)	160	250	400	630
Rated Voltage $V_R$ (VAC)	90	200	220	250
Capacitance Range ( $\mu\text{F}$ )	0.022 – 4.7	0.01 – 3.3	0.0068 – 1.5	0.001 – 0.68
Capacitance Values	E6 series (IEC 60063) measured at 1 kHz and $+20 \pm 1^\circ\text{C}$			
Capacitance Tolerance	$\pm 5\%$ , $\pm 10\%$ , $\pm 20\%$			
Operating Temperature Range	$-55^\circ\text{C}$ to $+105^\circ\text{C}$			
Rated Temperature $T_R$	$+85^\circ\text{C}$			
Maximum Self-heating	$10^\circ\text{C}$ at Rated Temperature			
Voltage Derating	Above $+85^\circ\text{C}$ DC and AC voltage derating is 1.25%/°C			

### Maximum Humidity in Storage Conditions

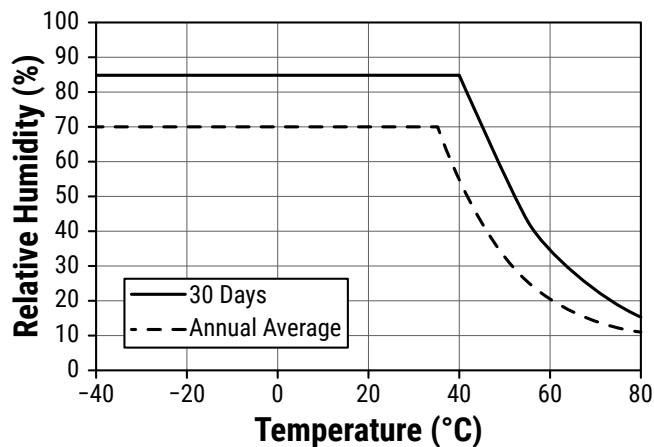

## Performance Characteristics cont.

Climatic Category	55/105/56 IEC 60068-1			
Storage Conditions	Storage time: ≤ 24 months from the date marked on the package label			
	Average relative humidity per year ≤ 70%			
	RH ≤ 85% for 30 days randomly distributed throughout the year			
	Dew is absent			
	Temperature: -40 to 80°C (see "Maximum Humidity in Storage Conditions" graph below)			
Test Voltage	1.6 x V <sub>R</sub> VDC for 2 seconds (between terminations) at +25°C ±5°C			
Capacitance Drift	Maximum 0.5% after a 2 year storage period at a temperature of +10°C to +40°C and a relative humidity of 40% to 60%			
Maximum Pulse Steepness	dV/dt according to Table 1. For working voltages lower than rated voltage (V < V <sub>R</sub> ), the specified dV/dt can be multiplied by the factor V <sub>R</sub> /V.			
Temperature Coefficient	-(200 ±100) ppm/°C at 1 kHz			
Self Inductance (Lead Length ~ 2 mm)	Maximum 1 nH per 1 mm lead and capacitor length			
Dissipation Factor tanδ	Maximum Values at 25°C ±5°C			
	Frequency	C ≤ 0.1 μF	0.1 μF < C ≤ 1 μF	C > 1 μF
	1 kHz	0.06%	0.06%	0.06%
	10 kHz	0.10%	0.20%	-
	100 kHz	0.30%	-	-
Insulation Resistance	Measured at +25°C ±5°C, 100 VDC 60 seconds			
	Minimum Values Between Terminals			
	C ≤ 0.33 μF	C > 0.33 μF		
	≥ 100,000 MΩ (≥ 500,000 MΩ) *	≥ 30,000 MΩ · μF (≥ 150,000 MΩ · μF) *		

\* Typical value

## Maximum Voltage ( $V_{rms}$ ) vs. Frequency (Sinusoidal Waveform/ $Th \leq 40^\circ C$ )

**160 VDC/90 VAC**

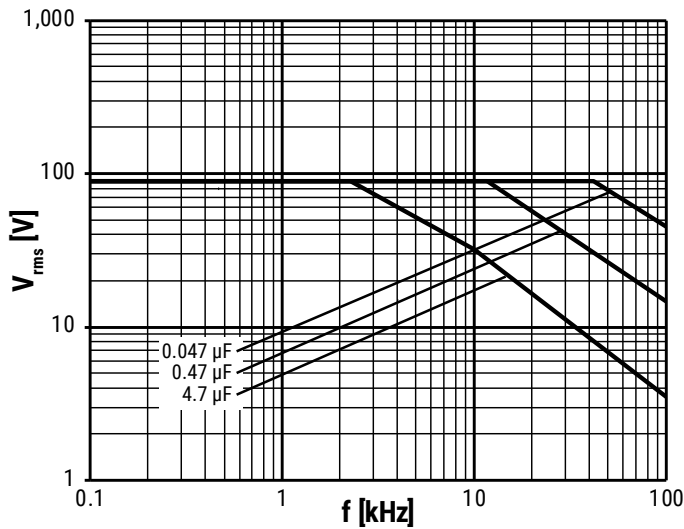

**250 VDC/200 VAC**

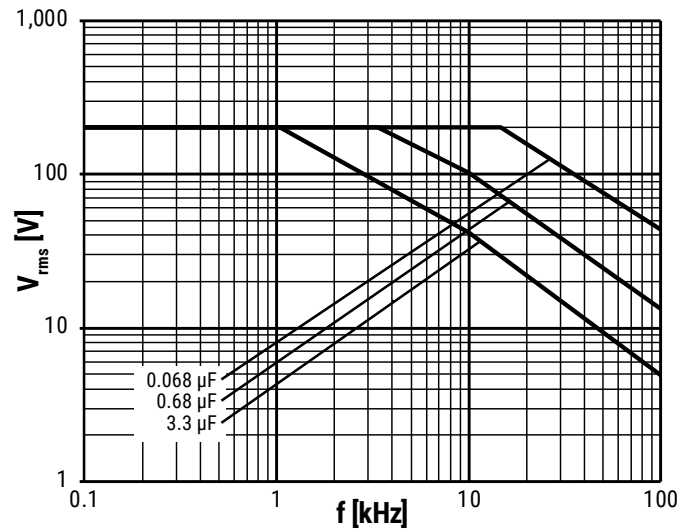

**400 VDC/220 VAC**

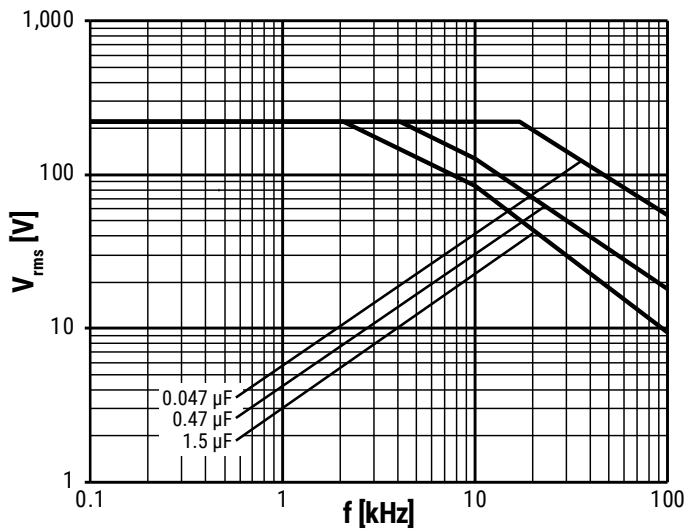

**630 VDC/250 VAC**

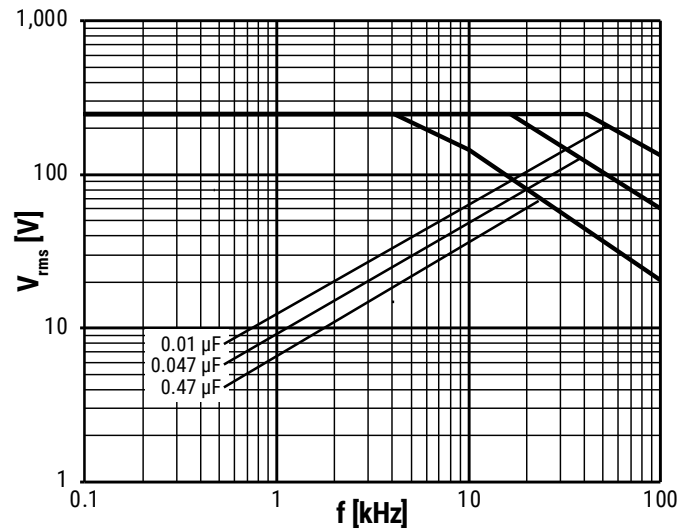

## Maximum Current ( $I_{rms}$ ) vs. Frequency (Sinusoidal Waveform/ $T_h \leq 40^\circ\text{C}$ )

160 VDC/90 VAC

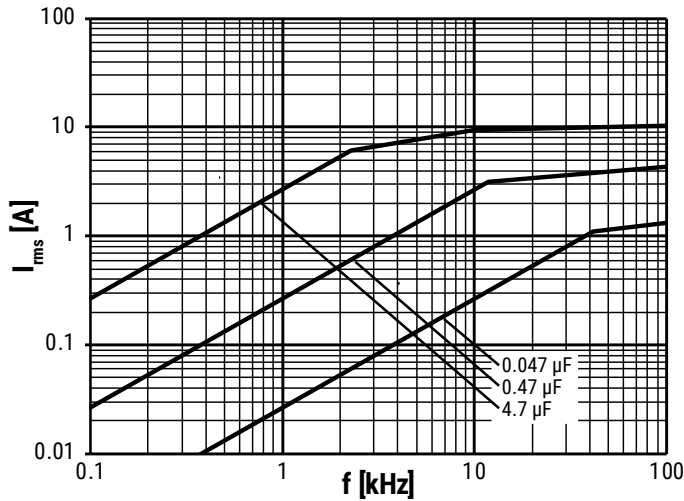

250 VDC/200 VAC

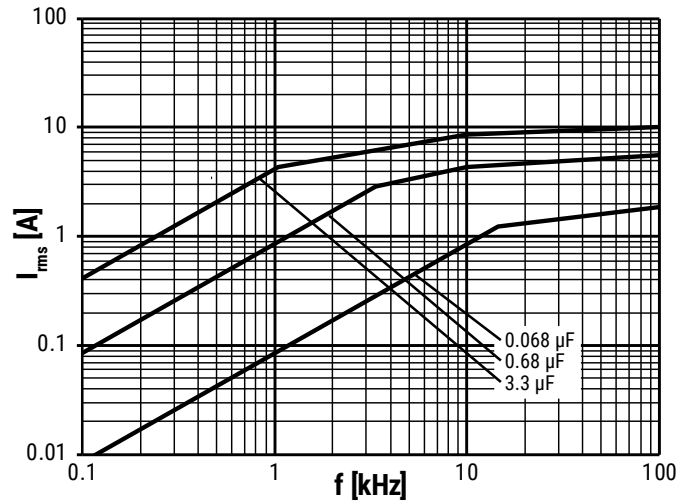

400 VDC/220 VAC

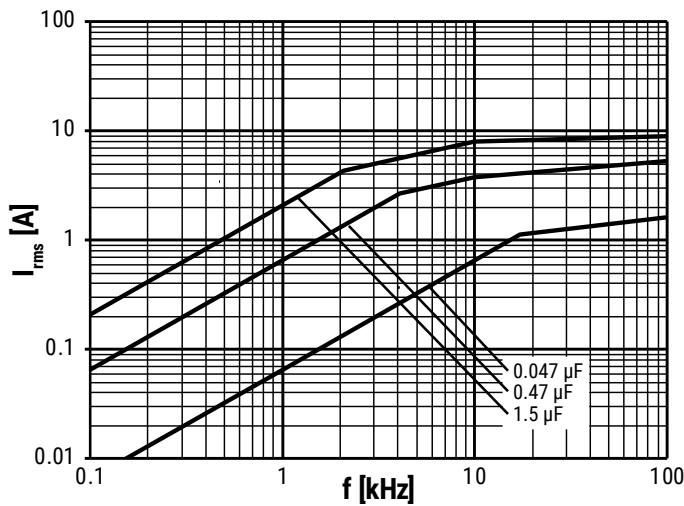

630 VDC/250 VAC

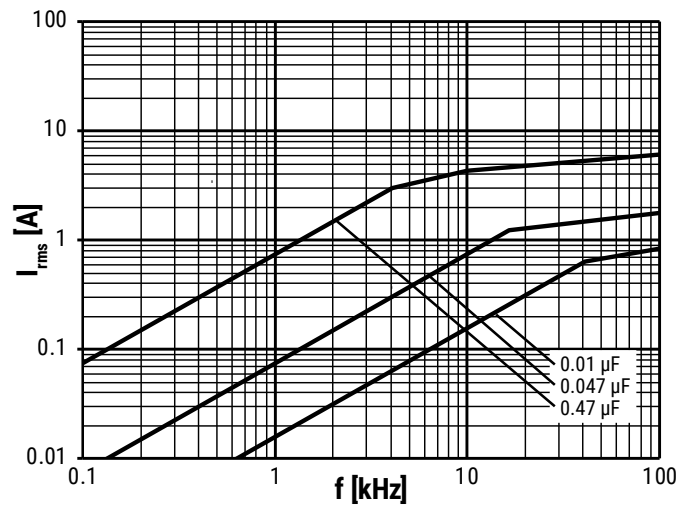

## Environmental Test Data

Damp Heat, Steady State Test	Test Conditions:		Performances
	Temperature: Relative humidity (RH): Test duration:	+40°C ±2°C 93% ±2% 56 days	Δ C/C  ≤ 2%, Δ tanδ ≤ 0.001 at 1 kHz IR after test ≥ 50% of initial limit
Endurance Test	Test Conditions		Performances
	Temperature: Voltage applied: Test duration:	+85°C ±2°C 1.25 x V <sub>R</sub> (DC) 2,000 hours	Δ C/C  ≤ 3%, Δ tanδ ≤ 0.001 at 10 kHz for C ≤ 1μF Δ tanδ ≤ 0.001 at 1 kHz for C > 1μF IR after test ≥ 50% of initial limit
Resistance to Soldering Heat Test	Test Conditions		Performances
	Solder bath temperature: Dipping time (with heat screen):	260°C ±5°C 10 seconds ±1 second	Δ C/C  ≤ 1%, Δ tanδ ≤ 0.001 at 10 kHz for C ≤ 1μF Δ tanδ ≤ 0.001 at 1 kHz for C > 1μF IR after test ≥ initial limit

## Environmental Compliance

All KEMET pulse capacitors are RoHS Compliant.

**Table 1 – Ratings & Part Number Reference**

VDC	VAC	Capacitance Value (μF)	Dimensions in mm		dV/dt (V/μs)	Max K <sub>0</sub> (V <sup>2</sup> /μs)	KEMET Internal Part Number	Customer Part Number
			D	L				
160	90	0.022	5.0	11.0	5	1,600	70GF2220(1)00(2)	A70GF2220(1)00(2)
160	90	0.033	5.0	11.0	5	1,600	70GF2330(1)00(2)	A70GF2330(1)00(2)
160	90	0.047	5.0	11.0	5	1,600	70GF2470(1)00(2)	A70GF2470(1)00(2)
160	90	0.068	5.5	14.0	5	1,600	70GH2680(1)00(2)	A70GH2680(1)00(2)
160	90	0.10	5.5	14.0	5	1,600	70GH3100(1)00(2)	A70GH3100(1)00(2)
160	90	0.15	6.5	14.0	5	1,600	70GH3150(1)00(2)	A70GH3150(1)00(2)
160	90	0.22	7.5	14.0	5	1,600	70GH3220(1)00(2)	A70GH3220(1)00(2)
160	90	0.33	7.0	20.5	3	960	70GK3330(1)00(2)	A70GK3330(1)00(2)
160	90	0.47	8.0	20.5	3	960	70GK3470(1)00(2)	A70GK3470(1)00(2)
160	90	0.68	8.0	28.0	2	640	70GQ3680(1)00(2)	A70GQ3680(1)00(2)
160	90	1.0	9.5	28.0	2	640	70GQ4100(1)00(2)	A70GQ4100(1)00(2)
160	90	1.5	11.0	28.0	2	640	70GQ4150(1)00(2)	A70GQ4150(1)00(2)
160	90	2.2	12.0	33.0	1	320	70GT4220(1)00(2)	A70GT4220(1)00(2)
160	90	3.3	14.5	33.0	1	320	70GT4330(1)00(2)	A70GT4330(1)00(2)
160	90	4.7	17.0	33.0	1	320	70GT4470(1)00(2)	A70GT4470(1)00(2)
250	200	0.010	5.0	11.0	11	5,500	70IF2100(1)00(2)	A70IF2100(1)00(2)
250	200	0.015	5.0	11.0	11	5,500	70IF2150(1)00(2)	A70IF2150(1)00(2)
250	200	0.022	5.5	14.0	10	5,000	70IH2220(1)00(2)	A70IH2220(1)00(2)
250	200	0.033	5.5	14.0	10	5,000	70IH2330(1)00(2)	A70IH2330(1)00(2)
250	200	0.047	6.0	14.0	10	5,000	70IH2470(1)00(2)	A70IH2470(1)00(2)
250	200	0.068	7.0	14.0	10	5,000	70IH2680(1)00(2)	A70IH2680(1)00(2)
250	200	0.10	8.5	14.0	10	5,000	70IH3100(1)00(2)	A70IH3100(1)00(2)
VDC	VAC	Capacitance Value (μF)	B (mm)	H (mm)	dV/dt (V/μs)	Max K <sub>0</sub> (V <sup>2</sup> /μs)	KEMET Internal Part Number	Customer Part Number

(1) Insert lead and packaging code. See Ordering Options Table for available options.

(2) J = 5%, K = 10%, M = 20%.

**Table 1 – Ratings & Part Number Reference cont.**

VDC	VAC	Capacitance Value (µF)	Dimensions in mm		dV/dt (V/µs)	Max K <sub>0</sub> (V <sup>2</sup> /µs)	KEMET Internal Part Number	Customer Part Number
			D	L				
250	200	0.15	7.5	20.5	7	3,500	70IK3150(1)00(2)	A70IK3150(1)00(2)
250	200	0.22	9.0	20.5	7	3,500	70IK3220(1)00(2)	A70IK3220(1)00(2)
250	200	0.33	8.5	28.0	4	2,000	70IQ3330(1)00(2)	A70IQ3330(1)00(2)
250	200	0.47	10.0	28.0	4	2,000	70IQ3470(1)00(2)	A70IQ3470(1)00(2)
250	200	0.68	11.5	28.0	4	2,000	70IQ3680(1)00(2)	A70IQ3680(1)00(2)
250	200	1.0	12.5	33.0	2.5	1,250	70IT4100(1)00(2)	A70IT4100(1)00(2)
250	200	1.5	15.0	33.0	2.5	1,250	70IT4150(1)00(2)	A70IT4150(1)00(2)
250	200	2.2	18.0	33.0	2.5	1,250	70IT4220(1)00(2)	A70IT4220(1)00(2)
250	200	3.3	21.5	33.0	2.5	1,250	70IT4330(1)00(2)	A70IT4330(1)00(2)
400	220	0.0068	5.0	11.0	25	20,000	70MF1680(1)00(2)	A70MF1680(1)00(2)
400	220	0.010	5.5	14.0	13.5	10,800	70MH2100(1)00(2)	A70MH2100(1)00(2)
400	220	0.015	6.0	14.0	13.5	10,800	70MH2150(1)00(2)	A70MH2150(1)00(2)
400	220	0.022	6.0	14.0	13.5	10,800	70MH2220(1)00(2)	A70MH2220(1)00(2)
400	220	0.033	6.5	14.0	13.5	10,800	70MH2330(1)00(2)	A70MH2330(1)00(2)
400	220	0.047	8.0	14.0	13.5	10,800	70MH2470(1)00(2)	A70MH2470(1)00(2)
400	220	0.068	7.0	20.5	10	8,000	70MK2680(1)00(2)	A70MK2680(1)00(2)
400	220	0.10	8.0	20.5	10	8,000	70MK3100(1)00(2)	A70MK3100(1)00(2)
400	220	0.15	8.0	28.0	6.5	5,200	70MQ3150(1)00(2)	A70MQ3150(1)00(2)
400	220	0.22	9.5	28.0	6.5	5,200	70MQ3220(1)00(2)	A70MQ3220(1)00(2)
400	220	0.33	11.0	28.0	6.5	5,200	70MQ3330(1)00(2)	A70MQ3330(1)00(2)
400	220	0.47	13.0	28.0	6.5	5,200	70MQ3470(1)00(2)	A70MQ3470(1)00(2)
400	220	0.68	13.5	33.0	4	3,200	70MT3680(1)00(2)	A70MT3680(1)00(2)
400	220	1.0	16.5	33.0	4	3,200	70MT4100(1)00(2)	A70MT4100(1)00(2)
400	220	1.5	20.0	33.0	4	3,200	70MT4150(1)00(2)	A70MT4150(1)00(2)
630	250	0.0010	5.0	11.0	30	37,800	70PF1100(1)00(2)	A70PF1100(1)00(2)
630	250	0.0015	5.0	11.0	30	37,800	70PF1150(1)00(2)	A70PF1150(1)00(2)
630	250	0.0022	5.0	11.0	30	37,800	70PF1220(1)00(2)	A70PF1220(1)00(2)
630	250	0.0033	5.0	11.0	30	37,800	70PF1330(1)00(2)	A70PF1330(1)00(2)
630	250	0.0047	5.0	11.0	30	37,800	70PF1470(1)00(2)	A70PF1470(1)00(2)
630	250	0.0068	5.5	14.0	20	25,200	70PH1680(1)00(2)	A70PH1680(1)00(2)
630	250	0.010	6.0	14.0	20	25,200	70PH2100(1)00(2)	A70PH2100(1)00(2)
630	250	0.015	7.0	14.0	20	25,200	70PH2150(1)00(2)	A70PH2150(1)00(2)
630	250	0.022	8.5	14.0	20	25,200	70PH2220(1)00(2)	A70PH2220(1)00(2)
630	250	0.033	7.5	20.5	15	18,900	70PK2330(1)00(2)	A70PK2330(1)00(2)
630	250	0.047	8.5	20.5	15	18,900	70PK2470(1)00(2)	A70PK2470(1)00(2)
630	250	0.068	8.5	28.0	10	12,600	70PQ2680(1)00(2)	A70PQ2680(1)00(2)
630	250	0.10	10.0	28.0	10	12,600	70PQ3100(1)00(2)	A70PQ3100(1)00(2)
630	250	0.15	11.5	28.0	10	12,600	70PQ3150(1)00(2)	A70PQ3150(1)00(2)
630	250	0.22	12.5	33.0	6	7,560	70PT3220(1)00(2)	A70PT3220(1)00(2)
630	250	0.33	15.0	33.0	6	7,560	70PT3330(1)00(2)	A70PT3330(1)00(2)
630	250	0.47	17.5	33.0	6	7,560	70PT3470(1)00(2)	A70PT3470(1)00(2)
630	250	0.68	21.0	33.0	6	7,560	70PT3680(1)00(2)	A70PT3680(1)00(2)
VDC	VAC	Capacitance Value (µF)	B (mm)	H (mm)	dV/dt (V/µs)	Max K <sub>0</sub> (V <sup>2</sup> /µs)	KEMET Internal Part Number	Customer Part Number

(1) Insert lead and packaging code. See Ordering Options Table for available options.

(2) J = 5%, K = 10%, M = 20%.



## Soldering Process

The implementation of the RoHS directive has resulted in the selection of SnAgCu (SAC) alloys or SnCu alloys as primary solder. This has increased the liquidus temperature from that of 183°C for SnPb eutectic alloy to 217 – 221°C for the new alloys. As a result, the heat stress to the components, even in wave soldering, has increased considerably due to higher pre-heat and wave temperatures. Polypropylene capacitors are especially sensitive to heat (the melting point of polypropylene is 160 – 170°C). Wave soldering can be destructive, especially for mechanically small polypropylene capacitors (with lead spacing of 5 mm to 15 mm), and great care has to be taken during soldering. The recommended solder profiles from KEMET should be used. Please consult KEMET with any questions. In general, the wave soldering curve from IEC Publication 61760–1 Edition 2 serves as a solid guideline for successful soldering. Please see Figure 1.

Reflow soldering is not recommended for through-hole film capacitors. Exposing capacitors to a soldering profile in excess of the above recommended limits may result in degradation or permanent damage to the capacitors.

Do not place the polypropylene capacitor through an adhesive curing oven to cure resin for surface mount components. Insert through-hole parts after the curing of surface mount parts. Consult KEMET to discuss the actual temperature profile in the oven, if through-hole components must pass through the adhesive curing process. A maximum two soldering cycles is recommended. Please allow time for the capacitor surface temperature to return to a normal temperature before the second soldering cycle.

### Manual Soldering Recommendations

Following is the recommendation for manual soldering with a soldering iron.



The soldering iron tip temperature should be set at 350°C (+10°C maximum) with the soldering duration not to exceed more than 3 seconds.

### Wave Soldering Recommendations

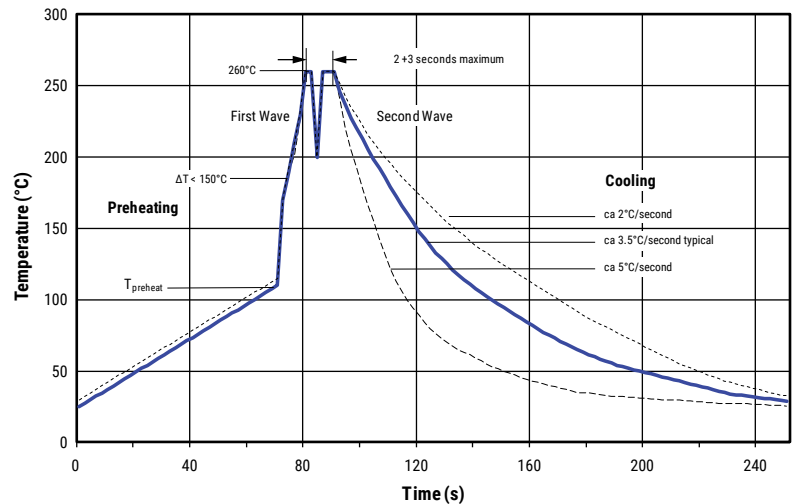

## Soldering Process cont.

### Wave Soldering Recommendations cont.

1. The table indicates the maximum set-up temperature of the soldering process  
Figure 1

Dielectric Film Material	Maximum Preheat Temperature		Maximum Peak Soldering Temperature	
	Capacitor Pitch ≤ 15 mm	Capacitor Pitch > 15 mm	Capacitor Pitch ≤ 15 mm	Capacitor Pitch > 15 mm
Polyester	130°C	130°C	270°C	270°C
Polypropylene	110°C	130°C	260°C	270°C
Paper	130°C	140°C	270°C	270°C
Polyphenylene Sulphide	150°C	160°C	270°C	270°C

2. The maximum temperature measured inside the capacitor:

Set the temperature so that inside the element the maximum temperature is below the limit:

Dielectric Film Material	Maximum temperature measured inside the element
Polyester	160°C
Polypropylene	110°C
Paper	160°C
Polyphenylene Sulphide	160°C



*Temperature monitored inside the capacitor.*

### Selective Soldering Recommendations

Selective dip soldering is a variation of reflow soldering. In this method, the printed circuit board with through-hole components to be soldered is preheated and transported over the solder bath as in normal flow soldering without touching the solder. When the board is over the bath, it is stopped and pre-designed solder pots are lifted from the bath with molten solder only at the places of the selected components, and pressed against the lower surface of the board to solder the components.

The temperature profile for selective soldering is similar to the double wave flow soldering outlined in this document, **however, instead of two baths, there is only one bath with a time from 3 to 10 seconds.** In selective soldering, the risk of overheating is greater than in double wave flow soldering. Great care must be taken so that the parts are not overheated.

## Construction

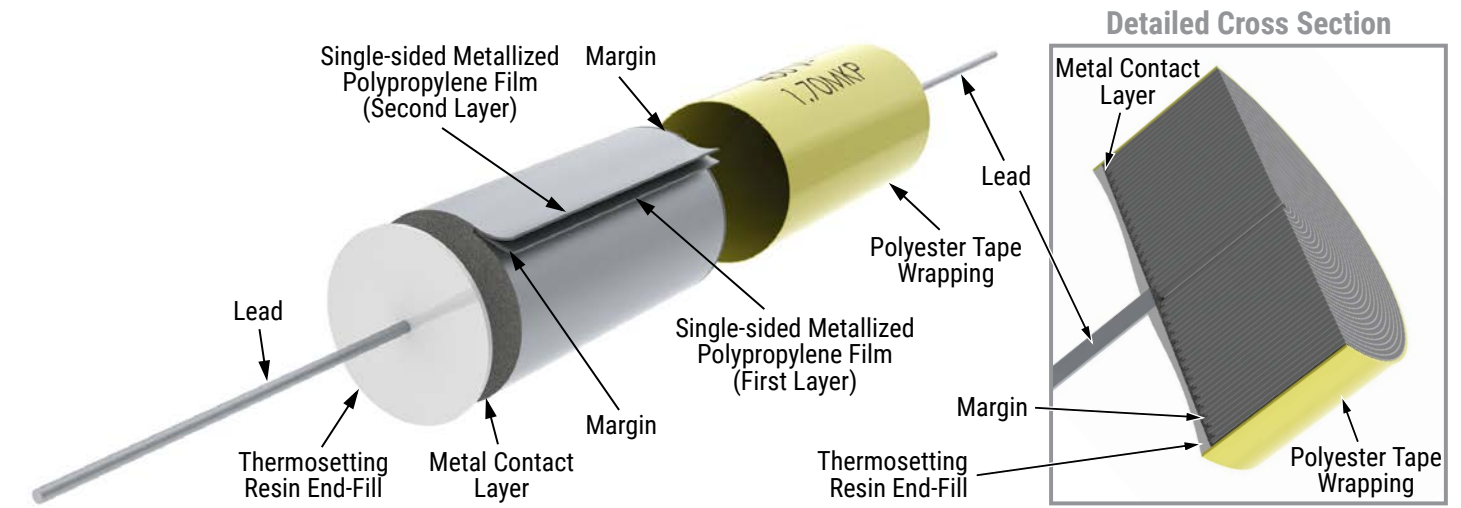

## Winding Scheme

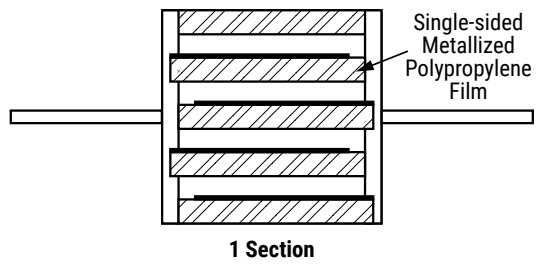

## Marking

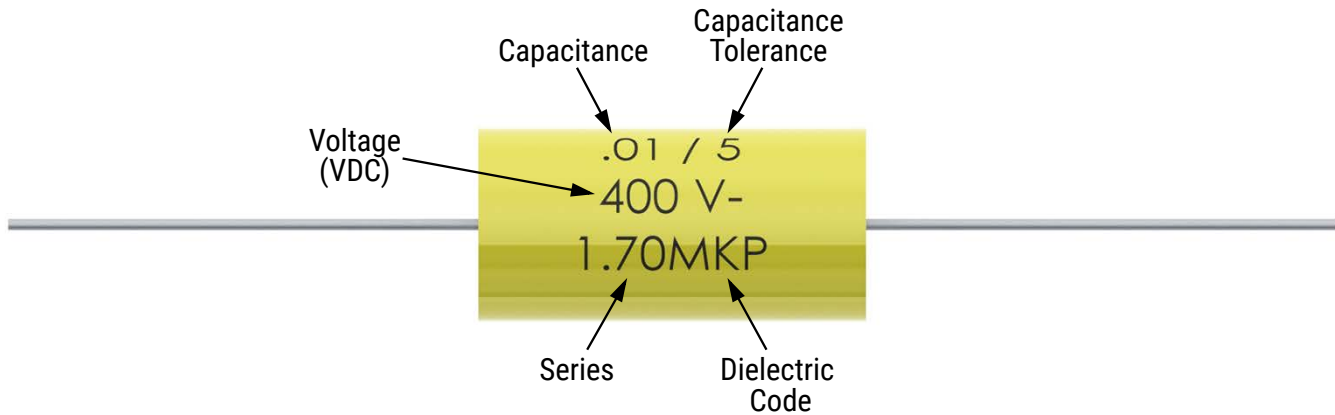

## Packaging Quantities

Diameter	Length	Bulk Long Leads	Standard Reel 355 mm
5.0	11.0	1,500	3,000
5.5	14.0	2,000	1,300
6.0	14.0	2,000	1,300
6.5	14.0	2,000	1,200
7.0	14.0	1,750	1,100
7.0	20.5	1,250	1,100
7.5	14.0	1,500	1,000
7.5	20.5	1,000	1,000
8.0	20.5	1,000	900
8.0	28.0	500	900
8.5	14.0	1,000	800
8.5	20.5	750	800
8.5	28.0	500	800
9.0	20.5	750	800
9.5	28.0	500	600
10.0	28.0	500	600

Diameter	Length	Bulk Long Leads	Standard Reel 355 mm
11.0	28.0	500	400
11.5	28.0	300	400
12.0	33.0	300	400
12.5	33.0	300	400
13.0	28.0	300	400
13.5	33.0	300	300
14.5	33.0	300	300
15.0	33.0	300	300
16.5	33.0	200	250
17.0	33.0	200	200
17.5	33.0	200	200
18.0	33.0	200	200
20.0	33.0	150	150
21.0	33.0	100	-
21.5	33.0	100	-

## Lead Taping & Packaging (IEC 60286-1)

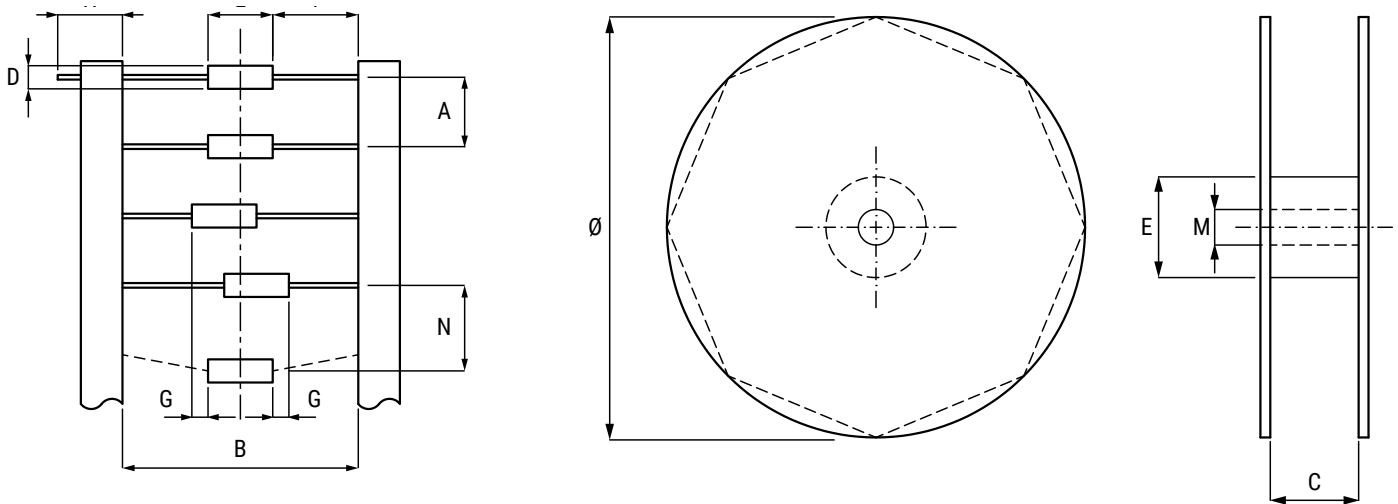

### Taping Specification

Description	Symbol	Dimensions (mm)
Component diameter	D	4.5 – 19.5
Body length	L	11 – 33
Component lead spacing	A <sup>(1)</sup>	See Table 1
Reel core diameter	E	85
Arbor hole diameter	M	30
Reel diameter	Ø	355 maximum
Tape width	H	6 ±0.5/9 ±1 <sup>(2)</sup>
Body location (lateral deviation)	G	≤ 0.7
Body location (longitudinal deviation)	N	≤ 1.2
Tape spacing	B	See Table 2
Lead length from the component body to the adhesive tape	I	≥ 20
Distance between reel flanges	C	See Table 2

(1) Maximum cumulative feed hole error 1.5 mm per 6 parts.

(2) 9±1 for capacitor with L ≥ 31.5.

Table 1

Dimensions in mm	
Diameter	A
≤ 5	5±0.5
5.1 – 9.5	10±0.5
9.6 – 14.7	15±0.5
14.8 – 19.5	20±1.0

Table 2

Dimensions in mm			
Length	Class	B <sup>±1.5</sup>	C
≤ 11	I	52.4	75
14 – 20.5	II	63.6	86
≥ 26	III	73	98

## KEMET Electronics Corporation Sales Offices

For a complete list of our global sales offices, please visit [www.kemet.com/sales](http://www.kemet.com/sales).

---

### Disclaimer

All product specifications, statements, information and data (collectively, the "Information") in this datasheet are subject to change. The customer is responsible for checking and verifying the extent to which the Information contained in this publication is applicable to an order at the time the order is placed. All Information given herein is believed to be accurate and reliable, but it is presented without guarantee, warranty, or responsibility of any kind, expressed or implied.

Statements of suitability for certain applications are based on KEMET Electronics Corporation's ("KEMET") knowledge of typical operating conditions for such applications, but are not intended to constitute – and KEMET specifically disclaims – any warranty concerning suitability for a specific customer application or use. The Information is intended for use only by customers who have the requisite experience and capability to determine the correct products for their application. Any technical advice inferred from this Information or otherwise provided by KEMET with reference to the use of KEMET's products is given gratis, and KEMET assumes no obligation or liability for the advice given or results obtained.

Although KEMET designs and manufactures its products to the most stringent quality and safety standards, given the current state of the art, isolated component failures may still occur. Accordingly, customer applications which require a high degree of reliability or safety should employ suitable designs or other safeguards (such as installation of protective circuitry or redundancies) in order to ensure that the failure of an electrical component does not result in a risk of personal injury or property damage.

Although all product-related warnings, cautions and notes must be observed, the customer should not assume that all safety measures are indicated or that other measures may not be required.

*KEMET is a registered trademark of KEMET Electronics Corporation.*



Компания «ЭлектроПласт» предлагает заключение долгосрочных отношений при поставках импортных электронных компонентов на взаимовыгодных условиях!

Наши преимущества:

- Оперативные поставки широкого спектра электронных компонентов отечественного и импортного производства напрямую от производителей и с крупнейших мировых складов;
- Поставка более 17-ти миллионов наименований электронных компонентов;
- Поставка сложных, дефицитных, либо снятых с производства позиций;
- Оперативные сроки поставки под заказ (от 5 рабочих дней);
- Экспресс доставка в любую точку России;
- Техническая поддержка проекта, помощь в подборе аналогов, поставка прототипов;
- Система менеджмента качества сертифицирована по Международному стандарту ISO 9001;
- Лицензия ФСБ на осуществление работ с использованием сведений, составляющих государственную тайну;
- Поставка специализированных компонентов (Xilinx, Altera, Analog Devices, Intersil, Interpoint, Microsemi, Aeroflex, Peregrine, Syfer, Eurofarad, Texas Instrument, Miteq, Cobham, E2V, MA-COM, Hittite, Mini-Circuits, General Dynamics и др.);

Помимо этого, одним из направлений компании «ЭлектроПласт» является направление «Источники питания». Мы предлагаем Вам помощь Конструкторского отдела:

- Подбор оптимального решения, техническое обоснование при выборе компонента;
- Подбор аналогов;
- Консультации по применению компонента;
- Поставка образцов и прототипов;
- Техническая поддержка проекта;
- Защита от снятия компонента с производства.



#### Как с нами связаться

**Телефон:** 8 (812) 309 58 32 (многоканальный)

**Факс:** 8 (812) 320-02-42

**Электронная почта:** [org@eplast1.ru](mailto:org@eplast1.ru)

**Адрес:** 198099, г. Санкт-Петербург, ул. Калинина, дом 2, корпус 4, литера А.