

Since 2001, CJ1M-series PLCs are in control of a wide variety of applications worldwide.

The accumulated experience and advancements in technology now result in CJ2M; fully compatible, yet fully new.



CJ2M-MD21□



CJ2M-CPU3□



CJ2M-CPU1□

- Increased performance, and increased memory capacity
- Up to 40 I/O unit on any CPU
- Pulse I/O Modules add position control functions to any CPU
- USB for plug-and-play access to the PLC
- All models available with or without Ethernet port
- Choice of serial port plug-in modules

## Features

- Five variations in program capacity from 5K steps to 60K steps; scale the CPU to your application needs.
- Faster processors; LD instruction execution time is reduced to 40 ns, floating point trigonometrics in less than 1  $\mu$ s.
- Optional Pulse I/O Modules can be mounted to enable positioning functions for up to four axes. The module provides high-speed counters, interrupt inputs and pulse train/PWM outputs. (CJ2M CPU Units with Unit Version 2.0 or Later)
- Faster Function Block calls and execution, faster interrupt handling, less overhead time.
- Added execution memory for Function Blocks allows structured, object-oriented programming even in entry-level CPUs.
- General-purpose Ethernet port supports EtherNet/IP tag-based data links, connection to Support Software, communications between PLCs, FTP data transfers, and more (CJ2M-CPU3□).
- Standard USB port on all models allows Support Software to connect directly through standard USB cable.
- A Serial Option Module can be mounted to add RS-232C or RS-422A/485 communications ports (CJ2M-CPU3□).
- Compatible with all existing CJ1 power supply-, I/O-, control- and communication units.

## Ordering Information

### International Standards

- The standards are abbreviated as follows: U: UL, U1: UL (Class I Division 2 Products for Hazardous Locations), C: CSA, UC: cULus, UC1: cULus (Class I Division 2 Products for Hazardous Locations), CU: cUL, N: NK, L: Lloyd, and CE: EC Directives.
- Contact your OMRON representative for further details and applicable conditions for these standards.

## CJ2M CPU Units (Built-in EtherNet/IP)

Product name	Specifications						Current consumption (A)		Model	Standards
	I/O capacity/ Mountable Units (Expansion Racks)	Program capacity	Data memory capacity	LD instruction execution time	EtherNet/IP function	Option board slot	5 V	24 V		
<b>CJ2M (Built-in EtherNet/IP) CPU Units</b> 	2,560 points/ 40 Units (3 Expansion Racks max.)	60K steps	160K words (DM: 32K words, EM: 32K words x 4 banks)	0.04 μs	YES	YES	0.7 (See note.)	-	CJ2M-CPU35	UC1, N, L, CE
		30K steps							CJ2M-CPU34	
		20K steps	64K words (DM: 32K words, EM: 32K words x 1 bank)						CJ2M-CPU33	
		10K steps							CJ2M-CPU32	
		5K steps							CJ2M-CPU31	

**Note:** Add 0.005A, 0.030A and 0.075A when using Serial Communications Option Boards (CP1W-CIF01/CIF11/CIF12-V1), respectively.  
 Add 0.15A/Unit when using NT-AL001 RS-232C/RS-422A Adapters.  
 Add 0.04A/Unit when using CJ1W-CIF11 RS-422A Adapters.  
 Add 0.20A/Unit when using NV3W-M□20L(-V1) Programmable Terminals.



## CJ2M CPU Units

Product name	Specifications						Current consumption (A)		Model	Standards
	I/O capacity/ Mountable Units (Expansion Racks)	Program capacity	Data memory capacity	LD instruction execution time	EtherNet/IP function	Option board slot	5 V	24 V		
<b>CJ2M CPU Units</b> 	2,560 points/ 40 Units (3 Expansion Racks max.)	60K steps	160K words (DM: 32K words, EM: 32K words x 4 banks)	0.04 μs	-	-	0.5 (See note.)	-	CJ2M-CPU15	UC1, N, L, CE
		30K steps							CJ2M-CPU14	
		20K steps	64K words (DM: 32K words, EM: 32K words x 1 bank)						CJ2M-CPU13	
		10K steps							CJ2M-CPU12	
		5K steps							CJ2M-CPU11	

**Note:** Add 0.15A/Unit when using NT-AL001 RS-232C/RS-422A Adapters.  
 Add 0.04A/Unit when using CJ1W-CIF11 RS-422A Adapters.  
 Add 0.20A/Unit when using NV3W-M□20L(-V1) Programmable Terminals.

## Serial Communications Option Boards (Only CJ2M-CPU3□)

The serial communications port can be equipped by installing the serial communications option board to the option board slot in front of CPU unit.

Product name	Specifications	Serial communications mode	Current consumption (A)		Model	Standards
			5 V	24 V		
<b>RS-232C Option Board</b> 	One RS-232C port Connector: D-Sub, 9 pin, female Maximum transmission distance: 15m	Host Link, 1:N NT Link, No-protocol, Serial PLC Link Slave, Serial PLC Link Master, Serial Gateway converted to CompoWay/F, and Tool Bus *	0.005	-	CP1W-CIF01	UC1, N, L, CE
<b>RS-422A/485 Option Board</b> 	One RS-422A/485 port Terminal block: using ferrules Maximum transmission distance: 50m		0.030	-	CP1W-CIF11	
<b>RS-422A/485 Isolated-type Option Board</b> 	One RS-422A/485 port (Isolated) Terminal block: using ferrules Maximum transmission distance: 500m		0.075	-	CP1W-CIF12-V1	

**Note:** It is not possible to use a CP-series Ethernet Option Board (CP1W-CIF41), LCD Option Board (CP1W-DAM01) with a CJ2M CPU Unit.  
 \* The following modes cannot be used: 1:1 NT Link, Serial Gateway converted to Host Link FINS, 1:1 Link Master, and 1:1 Link Slave.

### Pulse I/O Modules (Only CJ2M CPU Unit with Unit Version 2.0 or Later)







Optional Pulse I/O Modules can be mounted to enable pulse I/O. Up to two Pulse I/O Modules can be mounted to the left side of a CJ2M CPU Unit.







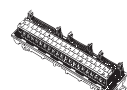

Product name	Specifications	Current consumption (A)		Model	Standards
		5 V	24 V		
 <b>Pulse I/O Modules</b>	Sinking outputs, MIL connector 10 inputs (including four interrupt/quickresponse inputs and two high-speed counter inputs) 6 outputs (including two pulse outputs and two PWM outputs)	0.08	---	<b>CJ2M-MD211</b>	UC1, N, L, CE
	Sourcing outputs, MIL connector 10 inputs (including four interrupt/quickresponse inputs and two high-speed counter inputs) 6 outputs (including two pulse outputs and two PWM outputs)	0.08	---	<b>CJ2M-MD212</b>	

**Note:** Connectors are not provided with Pulse I/O Modules. Purchase the following Connector, an OMRON Cable with Connectors for Connector Terminal Block Conversion Units, or an OMRON Cable with Connectors for Servo Relay Units.

### Connecting to Pulse I/O Modules

On wiring, refer to Pulse I/O Modules Connector Wiring Methods.

Product name	Specifications	Model	Standards
<b>Applicable Connector</b> 	MIL Flat Cable Connectors (Pressure-fitted Connectors)	<b>XG4M-4030-T</b>	---
<b>Connector-Terminal Block Conversion Units</b>	Phillips screw (M3 screw terminals,40-terminals) 	<b>XW2R-J40G-T</b>	---
	Slotted screw (M3 European type ,40-terminals) 	<b>XW2R-E40G-T</b>	
	Push-in spring(Clamp 40-terminals) 	<b>XW2R-P40G-T</b>	
<b>Cable for Connector-Terminal Block Conversion Unit</b>		Cable length: 0.25 m	<b>XW2Z-C25K</b>
		Cable length: 0.5 m	<b>XW2Z-C50K</b>
		Cable length: 1 m	<b>XW2Z-100K</b>
		Cable length: 1.5 m	<b>XW2Z-150K</b>
		Cable length: 2 m	<b>XW2Z-200K</b>
		Cable length: 3 m	<b>XW2Z-300K</b>
		Cable length: 5 m	<b>XW2Z-500K</b>
<b>Servo Relay Units</b>	Servo Relay Unit for 1 axis 	<b>XW2B-20J6-8A</b>	---
	Servo Relay Unit for 2 axes 	<b>XW2B-40J6-9A</b>	

Product name	Specifications			Model	Standards
Cables for Servo Relay Units	G5/G Series	Cable for Pulse I/O Modules 	Cable length: 0.5 m	XW2Z-050J-A33	---
		Cable length: 1 m	XW2Z-100J-A33		
		Servo Driver Connecting Cables 	Cable length: 1 m	XW2Z-100J-B31	
		Cable length: 2 m	XW2Z-200J-B31		
	SMARTSTEP2	Cable for Pulse I/O Modules 	Cable length: 0.5 m	XW2Z-050J-A33	
		Cable length: 1 m	XW2Z-100J-A33		
		Servo Driver Connecting Cables 	Cable length: 1 m	XW2Z-100J-B32	
		Cable length: 2 m	XW2Z-200J-B32		
	SMARTSTEP Junior	Cable for Pulse I/O Modules 	Cable length: 1 m	XW2Z-100J-A26	
		Cable length: 2 m	XW2Z-200J-B17		
		Servo Driver Connecting Cables 	Cable length: 1 m	XW2Z-100J-B17	
		Cable length: 2 m	XW2Z-200J-B17		
	SMARTSTEP A Series	Cable for Pulse I/O Modules 	Cable length: 1 m	XW2Z-100J-A26	
		Servo Driver Connecting Cables 	Cable length: 1 m	XW2Z-100J-B5	
Cable length: 2 m		XW2Z-200J-B5			

## Accessories

The following accessories come with CPU Unit:

Item	Specification
Battery	CJ1W-BAT01
End Cover	CJ1W-TER01 (necessary to be mounted at the right end of CPU Rack)
End Plate	PFP-M (2 pcs)

**Note:** A serial port (RS-232C) connector is not provided. Purchase a connector separately for serial port connection.  
 XM3A-0921 (manufactured by OMRON) or equivalent  
 XM2S-0911-E (manufactured by OMRON) or equivalent

## General Specifications

Item	CJ2M-	
	CPU1□	CPU3□
Enclosure	Mounted in a panel	
Grounding	Less than 100 Ω	
CPU Unit Dimensions	90 mm × 75 mm × 31 mm	90 mm × 75 mm × 62 mm
Weight *1	130 g or less	190 g or less *2
Current Consumption	5 VDC, 0.5 A	5 VDC, 0.7 A
Operation Environment	Ambient Operating Temperature	0 to 55°C
	Ambient Operating Humidity	10% to 90% (with no condensation)
	Atmosphere	Must be free from corrosive gases.
	Ambient Storage Temperature	-20 to 70°C (excluding battery)
	Altitude	2,000 m or less
	Pollution Degree	2 or less: Conforms to JIS B3502 and IEC 61131-2.
	Noise Immunity	2 kV on power supply line (Conforms to IEC 61000-4-4.)
	Overvoltage Category	Category II: Conforms to JIS B3502 and IEC 61131-2.
	EMC Immunity Level	Zone B
Vibration Resistance	Conforms to IEC60068-2-6 5 to 8.4 Hz with 3.5-mm amplitude, 8.4 to 150 Hz Acceleration of 9.8 m/s <sup>2</sup> for 100 min in X, Y, and Z directions (10 sweeps of 10 min each = 100 min total)	
	Shock Resistance	Conforms to IEC60068-2-27 147 m/s <sup>2</sup> , 3 times in X, Y, and Z directions (100 m/s <sup>2</sup> for Relay Output Units)
Battery		Life
	Weight	Approx. 10 g
	Model	CJ1W-BAT01
Applicable Standards	Conforms to cULus, NK, LR, and EC Directives.	

**Note:** 1. Includes weight of end covers and battery.  
 2. Without a Serial Option Board.

## Performance Specifications

Items		CJ2M-				
		CPU11/31	CPU12/32	CPU13/33	CPU14/34	CPU15/35
User Memory		5K steps	10K steps	20K steps	30K steps	60K steps
I/O Bits		2,560 bits				
Processing Speed	Overhead Processing Time	Normal Mode: CJ2M-CPU3□: 270 μs * CJ2M-CPU1□: 160 μs * * The following time must be added when using EtherNet/IP tag data links for the CJ2M-CPU3□. 100 μs + (Number of words transferred × 1.8 μs) The following time must be added when using Pulse I/O Modules with a CJ2M CPU Unit: 10 μs × Number of Pulse I/O Modules				
		Execution Time		Basic Instructions : 0.04 μs min. Special Instructions : 0.06 μs min.		
	Interrupts	I/O Interrupts and External Interrupts	Interrupt task startup time: 31 μs Return time to cyclic task : 10 μs			
		Scheduled Interrupts	Minimum time interval : 0.4 ms (set in 0.1 ms increments) Interrupt task startup time: 30 μs Return time to cyclic task : 11 μs			
Maximum Number of Connectable Units		Total per CPU Rack or Expansion Rack: 10 Units max.; Total per PLC: 40 Units max.				
	Basic I/O Units	No limit However, a maximum of two CJ1W-INT01 Interrupt Input Units can be mounted.				
	Special I/O Units	Units for up to 96 unit numbers can be mounted. (Unit numbers run from 0 to 95. Units are allocated between 1 and 8 unit numbers.)				
	CPU Bus Units	CJ2M-CPU3□: 15 Units max. CJ2M-CPU1□: 16 Units max.				
	Pulse I/O Modules	2 Units max. * * Supported only by CJ2M CPU Units with unit version 2.0 or later. A Pulse I/O Module must be mounted.				
	Slots for which interrupts can be used	Slots 0 to 4 on CPU Rack				
Maximum Number of Expansion Racks		3 max.				
CIO Area	I/O Area	2,560 bits (160 words) : Words CIO 0000 to CIO 0159				
	Link Area	3,200 bits (200 words) : Words CIO 1000 to CIO 1199				
	CPU Bus Unit Area	6,400 bits (400 words) : Words CIO 1500 to CIO 1899				
	Special I/O Unit Area	15,360 bits (960 words) : Words CIO 2000 to CIO 2959				
	Pulse I/O Area	20 inputs, 12 outputs (CIO 2960 to CIO 2963) * * Supported only by CJ2M CPU Units with unit version 2.0 or later. A Pulse I/O Module must be mounted.				
	Serial PLC Link Words	1,440 bits (90 words) : Words CIO 3100 to CIO 3189				
	DeviceNet Area	9,600 bits (600 words) : Words CIO 3200 to CIO 3799				
	Internal I/O Area	3,200 bits (200 words) : Words CIO 1300 to CIO 1499 (Cannot be used for external I/O.) 37,504 bits (2,344 words): Words CIO 3800 to CIO 6143 (Cannot be used for external I/O.)				
Work Area		8,192 bits (512 words): Words W000 to W511 (Cannot be used for external I/O.)				
Holding Area		8,192 bits (512 words): Words H000 to H511 Bits in this area maintain their ON/OFF status when PLC is turned OFF or operating mode is changed. Words H512 to H1535: These words can be used only for function blocks. They can be used only for function block instances (i.e., they are allocated only for internal variables in function blocks).				
Auxiliary Area		Read-only: 31,744 bits (1,984 words) • 7,168 bits (448 words): Words A0 to A447 • 24,576 bits (1,536 words): Words A10000 to A11535 * Read/write: 16,384 bits (1,024 words) in words A448 to A1471 * * A960 to A1471 and A10000 to A11535 cannot be accessed by CPU Bus Units, Special I/O Units, PTs, and Support Software that do not specifically support the CJ2 CPU Units.				
Temporary Area		16 bits: TR0 to TR15				
Timer Area		4,096 timer numbers (T0000 to T4095 (separate from counters))				
Counter Area		4,096 counter numbers (C0000 to C4095 (separate from timers))				
DM Area		32k words * • DM Area words for Special I/O Units: D20000 to D29599 (100 words × 96 Units) • DM Area words for CPU Bus Units: D30000 to D31599 (100 words × 16 Units) * Bits in the EM Area can be addressed either by bit or by word. These bits cannot be addressed by CPU Bus Units, Special I/O Units, PTs, and Support Software that do not specifically support the CJ2 CPU Units.				
EM Area			32k words/bank × 4 banks max.: E00_00000 to E3_32767 max. *			
			* Bits in the EM Area can be addressed either by bit or by word. These bits cannot be addressed by CPU Bus Units, Special I/O Units, PTs, and Support Software that do not specifically support the CJ2 CPU Units.			
			32K words × 1 bank			
Force-S/R Enabled Banks *1		Bank 0 hex		32K words × 4 banks Bank 0 to 3 hex		
Index Registers		IR0 to IR15 These are special registers for storing PLC memory addresses for indirect addressing. (Index Registers can be set so that they are unique in each task or so that they are shared by all tasks.)				
Cyclic Task Flag Area		128 flags				
Memory Card		128 MB, 256 MB, or 512 MB				
Operating Modes		PROGRAM Mode: Programs are not executed. Preparations can be executed prior to program execution in this mode. MONITOR Mode: Programs are executed, and some operations, such as online editing, and changes to present values in I/O memory, are enabled in this mode. RUN Mode: Programs are executed. This is the normal operating mode.				

\*1. Force-setting/resetting bits in the EM Area is possible only for banks specified for the EM Area force-set/reset function.

Items		CJ2M-				
		CPU11/31	CPU12/32	CPU13/33	CPU14/34	CPU15/35
<b>Execution Mode</b>		Normal Mode				
<b>Programming Languages</b>		Ladder Logic (LD), Sequential Function Charts (SFC), Structured Text (ST), and Instruction Lists (IL)				
<b>Function Blocks</b>	<b>Maximum number of definitions</b>	256			2,048	
	<b>Maximum number of instances</b>	256			2,048	
<b>FB Program Area</b>		20K steps				
<b>Tasks</b>	<b>Type of Tasks</b>	Cyclic tasks Interrupt tasks (Power OFF interrupt tasks, scheduled interrupt tasks, I/O interrupt tasks, and external interrupt tasks, and input interrupt tasks *2)				
	<b>Number of Tasks</b>	Cyclic tasks: 128 Interrupt tasks: 256 (Interrupt tasks can be defined as cyclic tasks to create extra cyclic tasks. Therefore, the total number of cyclic tasks is actually 384 max.)				
<b>Symbols (Variables)</b>	<b>Type of Symbols</b>	<ul style="list-style-type: none"> <li>Local symbols: Can be used only within a single task in the PLC.</li> <li>Global symbols: Can be used in all tasks in the PLC.</li> <li>Network symbols (tags)*: I/O memory in the CPU Unit can be externally accessed using symbols, depending on parameter settings.</li> </ul> * Supported only by the CJ2M-CPU3□.				
	<b>Data Type of Symbols</b>	<ul style="list-style-type: none"> <li>BOOL (bit)</li> <li>UINT (one-word unsigned binary)</li> <li>UDINT (two-word unsigned binary)</li> <li>ULINT (four-word unsigned binary)</li> <li>INT (one-word signed binary)</li> <li>DINT (two-word signed binary)</li> <li>LINT (four-word signed binary)</li> <li>UINT BCD (one-word unsigned BCD) *3</li> <li>UDINT BCD (two-word unsigned BCD) *3</li> <li>ULINT BCD (four-word unsigned BCD) *3</li> <li>REAL (two-word floating-point)</li> <li>LREAL (four-word floating-point)</li> <li>CHANNEL (word) *3</li> <li>NUMBER (constant or number) *3</li> <li>WORD (one-word hexadecimal)</li> <li>DWORD (two-word hexadecimal)</li> <li>LWORD (four-word hexadecimal)</li> <li>STRING (1 to 255 ASCII characters)</li> <li>TIMER (timer) *4</li> <li>COUNTER (counter) *4</li> <li>User defined data types (data structures)</li> </ul>				
	<b>Maximum Size of Symbol</b>	32k words				
	<b>Array Symbols (Array Variables)</b>	One-dimensional arrays				
	<b>Number of Array Elements</b>	32,000 elements max.				
	<b>Number of Registrable Network Symbols (Tags) *5</b>	2,000 max.				
	<b>Length of Network Symbol (Tag) Name *5</b>	255 bytes max.				
	<b>Encoding of Network Symbols (Tags) *5</b>	UTF-8				
<b>Data Tracing</b>	<b>Memory Capacity</b>	8,000 words (The EM Area can be specified from the CX-Programmer to use up to 32K words multiplied by the number of banks supported by the CPU Unit model.)				
	<b>Number of Samplings</b>	Bits = 31, one-word data = 16, two-word data = 8, four-word data = 4				
	<b>Sampling Cycle</b>	1 to 2,550 ms (Unit: 1 ms)				
	<b>Trigger Conditions</b>	ON/OFF of specified bit Data comparison of specified word Data size: 1 word, 2 words, 4 words Comparison Method: Equals (=), Greater Than (>), Greater Than or Equals (≥), Less Than (<), Less Than or Equals (≤), Not Equal (≠)				
<b>Delay Value</b>	-32,768 to +32,767 ms					
<b>File Memory</b>		Memory Card (128, 256, or 512 Mbytes) (Use the Memory Cards provided by OMRON.) EM file memory (Part of the EM Area can be converted for use as file memory.)				
<b>Source/Comment Memory</b>	<b>Function block program memory, comment file, program index file, symbol tables</b>	Capacity: 1 Mbytes				
<b>Communications</b>	<b>Logical Ports for Communications</b>	<b>Logical Ports</b>	8 ports (Used for SEND, RECV, CMND, PMCR, TXDU, and RXDU instructions.)			
		<b>Extended Logical Ports</b>	64 ports (Used for SEND2, RECV2, CMND2, and PMCR2 instructions.)			
	<b>CIP Communications Specification</b>	<b>Class 3 (Connection Type)</b>	Number of connections: 64			
		<b>UCMM (Non-connection Type)</b>	Maximum number of clients that can communicate at the same time: 32 Maximum number of servers that can communicate at the same time: 40			

\*2. Supported only by CJ2M CPU Units with unit version 2.0 or later. A Pulse I/O Module must be mounted.

\*3. Cannot be used in Function blocks.

\*4. Can be used only in Function blocks.

\*5. Supported only by the CJ2M-CPU3□.

Item		CJ2M-					
		CPU11/31	CPU12/32	CPU13/33	CPU14/34	CPU15/35	
Communications	Peripheral (USB) Port	USB 2.0-compliant B-type connector					
	Baud Rate	12 Mbps max.					
	Transmission Distance	5 m max.					
	Serial Port	<ul style="list-style-type: none"> <li>• CJ2M-CPU1□ interface: Conforms to EIA RS-232C.</li> <li>• CJ2M-CPU3□: No serial ports with default system</li> </ul> One of the following Serial Option Boards can be mounted. <ul style="list-style-type: none"> <li>• CP1W-CIF01 RS-232C Option Board</li> <li>• CP1W-CIF11 RS-422A/485 Option Board (not isolated, max. transmission distance: 50 m)</li> <li>• CP1W-CIF12-V1 RS-422A/485 Option Board (isolated, max. transmission distance: 500 m)</li> </ul>					
	Communications Method	Half-duplex					
	Synchronization Method	Start-stop					
	Baud Rate	0.3, 0.6, 1.2, 2.4, 4.8, 9.6, 19.2, 38.4, 57.6, or 115.2 (kbps)					
	Transmission Distance	15 m max.					
	EtherNet/IP Port *6	-					
	Transmission Specifications	Media Access Method	CSMA/CD				
		Modulation	Baseband				
		Transmission Paths	Star				
		Baud Rate	100 Mbps (100Base-TX)				
		Transmission Media	Shielded twisted-pair (STP) cable; Categories: 5, 5e				
		Transmission Distance	100 m (between ethernet switch and node)				
		Number of Cascade Connections	No restrictions if ethernet switch is used.				
	Communications Specifications	CIP Communications: Tag Data Links					
		Number of Connections	32				
		Packet Interval (Refresh period)	1 to 10,000 ms (Unit: 0.5 ms) Can be set for each connection. (Data will be refreshed at the set interval, regardless of the number of nodes.)				
		Permissible Communications Band	3,000 packets per second *7				
		Number of Registerable Tag	32				
		Type of Tags	CIO, DM, EM, HR, WR, and Network symbols				
		Number of Tags per Connection	8 (Seven tags if PLC status is included in the segment.)				
		Maximum Link Data Size per Node (total size of all tags)	640 words				
		Maximum Data Size per Connection	640 words *8 (Data is synchronized within each connection.)				
		Number of Registrable Tag Set	32 (1 connection = 1 segment)				
		Maximum Tag Set Size	640 words *8 (One word is used when PLC status is included in the segment.)				
		Maximum Number of Tags Refreshable in a Single Cycle of CPU Unit *9	Output/send (CPU Unit to EtherNet/IP): 32 Input/receive (EtherNet/IP to CPU Unit): 32				
Data Size Refreshable in a Single Cycle of CPU Unit *9		Output/send (CPU to EtherNet/IP) : 640 words Input/receive (EtherNet/IP to CPU): 640 words					
Change of Tag Data Link Parameter Settings during Operation		OK *10					
Multi-cast Packet Filter *11		OK					
CIP Communications: Explicit Messages		-					
Class 3 (Connection Type)		Number of connections: 128					
UCMM (Non-connection Type)		Maximum number of clients that can communicate at the same time : 16 Maximum number of servers that can communicate at the same time: 16					
CIP Routing	OK (CIP routing is enabled for the following remote Units: CJ1W-EIP21, CJ2H-CPU6□-EIP, CJ2M-CPU3□, and CS1W-EIP21.)						
FINS Communications	-						
FINS/UDP	OK						
FINS/TCP	16 connections max.						
EtherNet/IP Conformance Test	Conforms to A5.						
EtherNet/IP Interface	10Base-T/100Base-TX Auto Negotiation/Fixed Setting						

\*6. The EtherNet/IP port is built into CJ2M-CPU3□ only.

\*7. "Packets per second" is the number of communications packets that can be processed per second.

\*8. Unit version 2.0 of built-in EtherNet/IP section: 20 words.

\*9. If the maximum number is exceeded, refreshing will require more than one CPU Unit cycle.

\*10. When changing parameters, however, the EtherNet/IP port where the change is made will be restarted. In addition, a timeout will temporarily occur at the other node that was communicating with that port, and it will then recover automatically.

\*11. The EtherNet/IP port supports an IGMP client, so unnecessary multicast packets are filtered by using an Ethernet switch that supports IGMP snooping.



## Function Specifications

Functions		Description	
Cycle Time Management	Minimum Cycle Time	A minimum cycle time can be set. (0.2 to 32,000 ms; Unit: 0.1 ms) The minimum cycle time setting can be changed in MONITOR mode.	
	Cycle Time Monitoring	The cycle time is monitored. (0.01 to 40,000 ms; Unit: 0.01 ms)	
	Background Processing	Instructions with long execution times can be executed over multiple cycles to prevent fluctuations in the cycle time.	
Unit (I/O) Management	Basic I/O Units, Special I/O Units, and CPU Bus Units	Cyclic Refreshing	Cyclic refreshing of Basic I/O Units, Special I/O Units, and CPU Bus Units
		Immediate Refreshing	I/O refreshing by immediate refreshing instructions
		Refreshing by IORF	I/O refreshing by IORF instruction
		Unit Recognition at Startup	The number of units recognized when the power is turned ON is displayed.
	Basic I/O Units	Input Response Time Setting	The input response times can be set for Basic I/O Units. The response time can be increased to reduce the effects of chattering and noise at input contacts. The response time can be decreased to enable detecting shorter input pulses.
		Load OFF Function	All of the outputs on Basic I/O Units can be turned OFF when an error occurs in RUN or MONITOR mode.
		Basic I/O Unit Status Monitoring	Alarm information can be read from Basic I/O Units and the number of Units recognized can be read.
		Reading/writing data using instructions for specific Units	Special instructions can be used to read/write required data for specific Units at high speed.
	Special I/O Units and CPU Bus Units	Unit Restart Bits to Restart Units	A Special I/O Unit or CPU Bus Unit can be restarted.
	Configuration Management	Automatic I/O Allocation at Startup	I/O words can be automatically allocated to the Basic I/O Units that are connected in the PLC to start operation automatically without registering Units into I/O tables.
		I/O Table Creation	The current unit configuration can be registered in I/O tables to prevent it from being changed, to reserve words, and to set words.
Rack/Slot First Word Settings		The first words allocated to a Units on the Racks can be set.	
Memory Management	Holding I/O Memory when Changing Operating Modes	The status of I/O memory can be held when the operating mode is changed or power is turned ON. The forced-set/reset status can be held when the operating mode is changed or power is turned ON.	
	File Memory	Files (such as program files, data files, and symbol table files) can be stored in Memory Card, EM File Memory, or Comment Memory.	
	Built-in Flash Memory	The user program and Parameter Area can be backed up to an internal flash memory when they are transferred to the CPU Unit.	
	EM File Function	Parts of the EM Area can be treated as file memory.	
	Storing Comments	I/O comments can be stored as symbol table files in a Memory Card, EM file memory, or comment memory.	
	EM Configuration	EM Area can be set as trace memory or EM file memory.	
Memory Cards	Automatic File Transfer at Startup	A program file and parameter files can be read from a Memory Card when the power is turned ON.	
	Program Replacement during PLC Operation	User programs can be transferred from a Memory Card to CPU Unit during operation.	
	Function for Reading and Writing Data from a Memory Card	Data in I/O memory in the CPU Unit can be written to a Memory Card in CSV/TXT format. Data in CSV/TXT format in the Memory Card can be read to I/O memory in the CPU Unit.	

Function		Description
<b>Communications</b>		–
<b>Communications</b>	<b>Peripheral (USB) Port</b>	<b>Peripheral Bus</b>
	Bus for communications with various kinds of Support Software running on a personal computer. High-speed communications are supported.	
	<b>Serial Port (Option) *12</b>	
	Application is possible when a Serial Communications Option Board is mounted.	
	<b>Host Link (SYSWAY) Communications</b>	
	Host Link commands or FINS commands placed between Host Link headers and terminators can be sent from a host computer or PT to read/write I/O memory, read/control the operating mode, and perform other operations for PLC.	
	<b>No-protocol Communications</b>	
	I/O instructions for communications ports (such as TXD/RXD instructions) can be used for data transfer with peripheral devices such as bar code readers and printers.	
	<b>NT Link Communications</b>	
	I/O memory in the PLC can be allocated and directly linked to various PT functions, including status control areas, status notification areas, touch switches, lamps, memory tables, and other objects.	
<b>Peripheral Bus</b>		Bus for communications with various kinds of Support Software running on a personal computer. High-speed communications are supported.
<b>Serial Gateway</b>		This gateway enables receiving and automatically converting FINS to the CompoWay/F.
<b>Serial PLC Links</b>		Data is exchanged between CPU Units using serial ports without communications programming. PTs set to the 1:N NT Link protocol can be included in the network.
<b>EtherNet/IP Port *13</b>		100Base-TX/10Base-T Protocols: TCP/IP, UDP, ARP, ICMP (ping only), BOOTP Applications: FINS, CIP, SNTP, DNS (Client), FTP (Server)
<b>Communications</b>	<b>CIP Communications Service</b>	<b>Tag Data Links</b>
		<b>Message Communications</b>
	<b>FINS Communications Service</b>	<b>Message Communications</b>
Programless cyclic data exchanges with the devices on the EtherNet/IP network.		
Any CIP commands can be received from the devices on the EtherNet/IP network.		
Any FINS commands can be transferred with the devices on the EtherNet/IP network.		
<b>Interrupt</b>	<b>Scheduled Interrupts</b>	
	Tasks can be executed at a specified interval (minimum of 0.2 ms, Unit: 0.1 ms).	
	<b>Resetting and restarting with MSKS(690)</b>	
	When MSKS(690) is executed, the internal timer is restarted and the time to first interrupt is set to a fixed value.	
	<b>Reading present value of internal timer with MSKS(690)</b>	
	MSKS(690) can be used to read the time that has elapsed until the schedule interrupt is started or since the previous scheduled interrupt.	
<b>Power OFF Interrupts</b>		A task can be executed when CPU Unit's power turns OFF.
<b>I/O Interrupt Tasks</b>		A task can be executed when an input signal is input to an Interrupt Input Unit.
<b>External Interrupt Tasks</b>		A task can be executed when interrupts are requested from a Special I/O Unit or a CPU Bus Unit.
<b>Clock</b>	<b>Clock Function</b>	
	Clock data is stored in memory. Accuracy (Accuracy depends on the temperature.) Ambient temperature of 55°C : -3.5 to +0.5 min error per month Ambient temperature of 25°C : -1.5 to +1.5 min error per month Ambient temperature of 0°C : -3 to +1 min error per month	
	<b>Operation Start Time Storage</b>	
	The time when operating mode was last changed to RUN mode or MONITOR mode is stored.	
	<b>Operation Stop Time Storage</b>	
	The last time a fatal error occurred or the last time the operating mode was changed to PROGRAM mode is stored.	
	<b>Startup Time Storage</b>	
	The time when the power was turned ON is stored.	
	<b>Power Interruption Time Storage</b>	
The time when the power is turned OFF is stored.		
<b>Total Power ON Time Calculation</b>		The total time that the PLC has been ON is stored in increments of 10 hours.
<b>Power ON Clock Data Storage</b>		A history of the times when the power was turned ON is stored.
<b>User Program Overwritten Time Storage</b>		The time that the user program was last overwritten is stored.
<b>Parameter Date Storage</b>		The time when the Parameter Area was overwritten is stored.
<b>Power Supply Management</b>	<b>Memory Protection</b>	
	Holding Area data, DM Area data, EM Area data, Counter Completion Flags, and counter present values are held even when power is turned OFF. CIO Area, Work Area, some Auxiliary Area data, and Timer Completion Flags, timer present values, index registers, and data registers can be protected by turning ON the IOM Hold Bit in the Auxiliary Area, and by also setting the IOM Hold Bit to "Hold" in the PLC Setup.	
	<b>Power OFF Detection Time Setting</b>	
	The detection time for power interruptions can be set. AC power supply: 10 to 25 ms (variable) DC power supply: 2 to 5 ms (CJ1W-PD022) or 2 to 20 ms (CJ1W-PD025)	
<b>Power OFF Detection Delay Time</b>		The detection of power interruptions can be delayed: 0 to 10 ms (Not supported by the CJ1W-PD022.)
<b>Number of Power Interruptions Counter</b>		The number of times power has been interrupted is counted.

\*12.A Serial Option Board is required to use a serial port for the CJ2M-CPU3□ CJ2M CPU Unit.

\*13.Supported only by the CJ2M-CPU3□.

Function		Description	
<b>Function Blocks</b>		Standard programming can be encapsulated as function blocks.	
	<b>Languages in Function Block Definitions</b>	Ladder programming or structured text	
<b>Debugging</b>	<b>Online Editing</b>	The program can be changed during operation (in MONITOR or PROGRAM mode), except for block programming areas.	
	<b>Force-Set/Reset</b>	Specified bits can be set or reset. Force-set/reset to the EM Area is enabled by specifying a start bank in parameter setting.	
	<b>Differentiate Monitoring</b>	ON/OFF changes in specified bits can be monitored.	
	<b>Data Tracing</b>	The specified I/O memory data can be stored in the trace memory in the CPU Unit. The triggers can be set.	
	<b>Continuous Tracing</b>	The trace data can be uploaded during data tracing using CX-Programmer, which enables continuously logging the data by constantly uploading the trace data.	
	<b>Automatically starting tracing when operation starts</b>	Data tracing can be automatically started when operation is started (i.e., when the operating mode is changed from PROGRAM mode to MONITOR or RUN mode).	
	<b>Storing Location of Error when an Error Occurs</b>	The location and task number where execution stopped for a program error is recorded.	
	<b>Program Check</b>	The programs can be checked for items such as no END instruction and FALS/FAL errors at startup.	
<b>Self-diagnosis and Restoration</b>	<b>Error Log</b>	A function is provided to store predefined error codes in CPU Unit, error information, and time at which the error occurred.	
	<b>CPU Error Detection</b>	CPU Unit WDT errors are detected.	
	<b>User-defined Failure Diagnosis</b>	Errors can be generated for user-specified conditions: Non-fatal errors (FAL) and fatal errors (FALS). Program section time diagnosis and program section logic diagnosis are supported (FPD instruction).	
	<b>Load OFF Function</b>	This function turns OFF all outputs from Output Units when an error occurs.	
	<b>RUN Output</b>	The RUN output from the CJ1W-PA205R turns ON while CPU Unit is in RUN mode or MONITOR mode.	
	<b>Basic I/O Load Short-circuit Detection</b>	This function provides alarm information from Basic I/O Units that have load short-circuit protection.	
	<b>Failure Point Detection</b>	The time and logic of an instruction block can be analyzed using the FPD instruction.	
	<b>CPU Standby Detection</b>	This function indicates when the CPU Unit is on standby because all Special I/O Units and CPU Bus Units have not been recognized at the startup in RUN or MONITOR mode.	
	<b>Non-fatal Error Detection</b>	<b>System FAL Error Detection (User-defined non-fatal error)</b>	This function generates a non-fatal (FAL) error when the user-defined conditions are met in program.
		<b>Duplicate Refreshing Error Detection</b>	This function detects an error when an immediate refreshing instruction in an interrupt task is competing with I/O refreshing of a cyclic task.
		<b>Basic I/O Unit Error Detection</b>	This function detects the errors in Basic I/O Units.
		<b>Backup Memory Error Detection</b>	This function detects errors in the memory backup of the user programs and parameter area (backup memory).
		<b>PLC Setup Error Detection</b>	This function detects setting errors in the PLC Setup.
		<b>CPU Bus Unit Error Detection</b>	This function detects an error when there is an error in data exchange between the CPU Unit and a CPU Bus Unit.
		<b>Special I/O Unit Error Detection</b>	This function detects an error when there is an error in data exchange between the CPU Unit and a Special I/O Unit.
		<b>Tag Memory Error Detection *14</b>	This function detects errors in tag memory.
		<b>Battery Error Detection</b>	This function detects an error when a battery is not connected to the CPU Unit or when the battery voltage drops.
		<b>CPU Bus Unit Setting Error Detection</b>	This function detects an error when the model of a CPU Bus Unit in the registered I/O tables does not agree with the model that is actually mounted in the PLC.
		<b>Special I/O Unit Setting Error Detection</b>	This function detects an error when the model of a Special I/O Unit in the registered I/O tables does not agree with the model of Unit that is actually mounted.
	<b>Option Board Error Detection *14</b>	This function detects the errors in Serial Option Board mounting status.	
	<b>Fatal Error Detection</b>	<b>Memory Error Detection</b>	This function detects errors that occur in memory of the CPU Unit.
		<b>I/O Bus Error Detection</b>	This function detects when an error occurs in data transfers between the Units mounted in Rack slots and the CPU Unit and detects when the End Cover is not connected to the CPU Rack or an Expansion Rack.
<b>Unit/Rack Number Duplication Error</b>		This function detects an error when the same unit number is set for two or more Units, the same word is allocated to two or more Basic I/O Units, or the same rack number is set for two or more Racks.	
<b>Too Many I/O Points Error Detection</b>		This function detects an error when the total number of I/O points set in the I/O tables or the number of Units per Rack exceeds the specified range.	
<b>I/O Setting Error Detection</b>		This function detects an error when the number of Units in the registered I/O tables does not agree with the actual number of Units that is mounted, or an Interrupt Unit has been connected in the wrong position, i.e., not in slot 0 to 4.	

\*14. Supported only by the CJ2M-CPU3□.

Function		Description	
Self-diagnosis and Restoration	Fatal Error Detection	<b>Program Error Detection</b>	This function detects errors in programs.
		<b>Instruction Processing Error Detection</b>	This function detects an error when the given data value is invalid when executing an instruction, or execution of instruction between tasks was attempted.
		<b>Indirect DM/EM BCD Error Detection</b>	This function detects an error when an indirect DM/EM address in BCD mode is not BCD.
		<b>Illegal Area Access Error Detection</b>	This function detects an error when an attempt is made to access an illegal area with an instruction operand.
		<b>No END Error Detection</b>	This function detects an error when there is no END instruction at the end of the program.
		<b>Task Error Detection</b>	This function detects an error when there are no tasks that can be executed in a cycle, there is no program for a task, or the execution condition for an interrupt task was met but there is no interrupt task with the specified number.
		<b>Differentiation Overflow Error Detection</b>	This function detects an error when too many differentiated instructions are entered or deleted during online editing (131,072 times or more).
		<b>Invalid Instruction Error Detection</b>	This function detects an error when an attempt is made to execute an instruction that is not defined in the system.
	Fatal Error Detection (Continued from previous page)	<b>User Program Area Overflow Error Detection</b>	This function detects an error when instruction data is stored after the last address in user program area.
		<b>Cycle Time Exceeded Error Detection</b>	This function monitors the cycle time (10 to 40,000 ms) and stops the operation when the set value is exceeded.
Maintenance	<b>Simple Backup Function</b>		This function collectively backs up the data in CPU Unit (user programs, parameters, and I/O memory) and internal backup data in the I/O Units.
	<b>Unsolicited Communications</b>		A function that allows the PLC to use Network Communications Instruction to send required FINS commands to a computer connected via a Host Link
	<b>Remote Programming and Monitoring</b>		Host Link communications can be used for remote programming and remote monitoring through a Controller Link, Ethernet, DeviceNet, or SYSMAC LINK Network. Communications across network layers can be performed. Controller Link or Ethernet : 8 layers DeviceNet or SYSMAC LINK : 3 layers
	<b>Automatic Online Connection via Network</b>	<b>Direct Serial Connection</b>	This function enables automatically connecting to the PLC online when the CX-Programmer is directly connected by a serial connection (peripheral (USB) port or serial port).
		<b>Via Networks</b>	This function enables connecting the CX-Programmer online to a PLC that is connected via an EtherNet/IP network.
Security	<b>Read Protection using Password</b>		This function protects reading and displaying programs and tasks using passwords. Write protection: Set using the DIP switch. Read protection: Set a password using the CX-Programmer.
	<b>FINS Write Protection</b>		This function prohibits writing by using FINS commands sent over the network.
	<b>Unit Name Function</b>		This function allows the users to give any names to the Units. Names are verified at online connection to prevent wrong connection
	<b>Hardware ID Using Lot Numbers</b>		This function sets operation protection by identifying hardware using the user programs according to lot numbers stored in the Auxiliary Area.

## Specifications for Pulse I/O Functions

The following functions of CJ2M can be used by installing one or two Pulse I/O Modules. Each module has 10 high-speed inputs and 6 high-speed outputs. Pulse I/O Modules can be installed on CJ2M CPU Units with Unit Version 2.0 or Later.

- The inputs can be used as general-purpose inputs, interrupt inputs, quick-response inputs, high-speed counters, or origin search inputs.
- The outputs can be used as general-purpose outputs, pulse outputs, origin search outputs, or PWM outputs.

### One Pulse I/O Module can be mounted

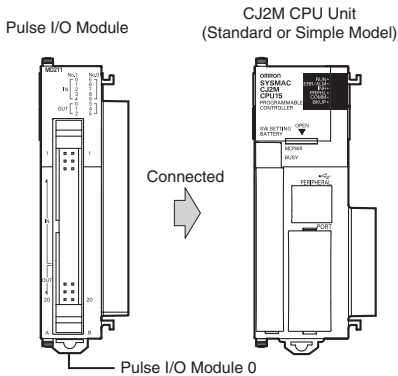

### Two Pulse I/O Modules can be mounted

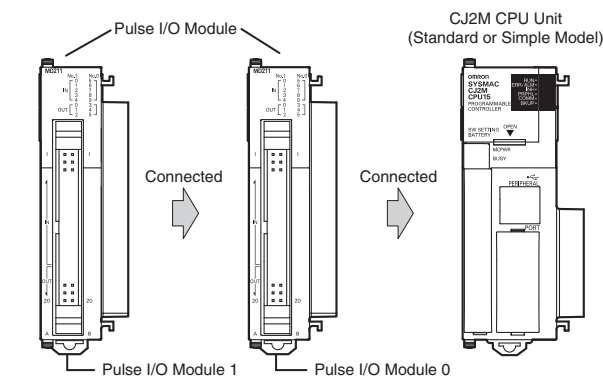

Note: The Pulse I/O Module closest to the CPU Unit is Pulse I/O Module 0 and the other one is Pulse I/O Module 1.

## Performance Specifications

Item		Description
Pulse I/O	<b>Model of Pulse I/O Modules</b>	CJ2M-MD211 (Sinking-type) CJ2M-MD212 (Sourcing-type)
	<b>External Interface</b>	40-pin MIL connector
	<b>Pulse Inputs</b>	Can be used as normal inputs, interrupt inputs, quick-response inputs, or high-speed counter inputs. (Function of each input must be selected in the PLC Setup.) Input method: Line-driver input or 24-VDC input (selected by wiring)
	<b>Normal Inputs</b>	20 max. (10 per Pulse I/O Module) Input constants: Set in the PLC Setup (0, 0.5, 1, 2, 4, 8, 16, or 32 ms). Default: 8 ms
	<b>Interrupt Inputs and Quick-response Inputs</b>	8 max. (4 per Pulse I/O Module) Input signal minimum ON pulse width: 30 μs
	<b>High-speed Counter Inputs</b>	4 max. (2 per Pulse I/O Module) Input method: Differential-phase (×4) pulses, pulse + direction, up/down pulses, or increment pulse Maximum response frequency: 50 kHz for differential phases or 100 kHz for single phase Counting mode: Linear mode or circular (ring) mode Count value: 32 bits Counter reset: Phase Z + software reset or software reset Control method: Target-value comparison or range comparison Gate function: Supported
	<b>Pulse Outputs</b>	Can be used as normal outputs, pulse outputs, or PWM outputs. (Function of each output must be selected in the PLC Setup.) Output method: Sinking or sourcing transistor outputs (The method is determined by Pulse I/O Module model.)
	<b>Normal Outputs</b>	12 max. (6 per Pulse I/O Module)
	<b>Pulse Outputs</b>	4 max. (2 per Pulse I/O Module) Output method: CW/CCW or pulse + direction (The method is determined by the I/O wiring and the instructions used in the ladder program.) Output frequency: 1 pps to 100 kpps (in increments of 1 pps) Output Mode: Continuous mode (for speed control) or independent mode (for position control) Output pulses: Relative coordinates: 0000 0000 to 7FFF FFFF hex (0 to 2,147,483,647 pulses) Absolute coordinates: 8000 0000 to 7FFF FFFF hex (-2,147,483,648 to 2,147,483,647) Acceleration/deceleration curves: Linear or S-curve Origin search function: Supported
	<b>PWM Outputs</b>	4 max. (2 per Pulse I/O Module) Output frequency: 0.1 to 6,553.5 Hz (in 0.1-Hz increments) or 1 to 32,800 Hz (in 1-Hz increments) Duty ratio: 0.0% to 100.0% (in 0.1% increments)

## Function Specifications

Functions		Description	
Pulse I/O Functions	<b>Pulse Input Functions</b>	<b>Normal Inputs</b>	Input signals are read during I/O refreshing and stored in I/O memory.
		<b>Interrupt Inputs</b>	An interrupt task can be started when an input signal turns ON or turns OFF.
		<b>Quick-response Inputs</b>	Input signals that are shorter than the cycle time are read and stored in I/O memory.
		<b>High-speed Counter Inputs</b>	High-speed pulse signals are counted. Interrupt tasks can also be started.
	<b>Pulse Output Functions</b>	<b>Normal Outputs</b>	The status of I/O memory is output during I/O refreshing.
		<b>Pulse Outputs</b>	A pulse signal is output with the specified frequency and number of pulses at a fixed duty ratio (50%).
		<b>PWM Outputs</b>	A pulse signal is output at the specified duty ratio.
<b>Origin Searches</b>		The origin point of the machine is determined according to the specified origin search parameters while actually outputting pulses and using the origin and origin proximity input signals as conditions. (Pulse inputs and outputs are also used for this function.)	
Interrupt	<b>Input Interrupt Function</b>		
	<b>Input Interrupts</b>	A task is started for an interrupt input from a Pulse I/O Module or for a high-speed counter input.	
		Interrupt tasks are executed when the interrupt input turns ON or turns OFF. Direct Mode: An interrupt task is executed each time an input signal changes. Counter Mode: Changes in the input signal are counted up or down and the interrupt task is executed when the counter counts out. (The maximum response frequency is 3 kHz.)	
<b>High-speed Counter Interrupts</b>	An interrupt task is executed when preset comparison conditions for a high-speed counter are met. Target-value comparison: The interrupt task is executed when the count matches a specified value. Range comparison: The interrupt task is executed when the count enters or leaves a specified range of values.		

## Allocating Functions I/O signals

### Pulse I/O Module 0 (on the right)

Terminal symbol		IN 00	IN 01	IN 02	IN 03	IN 04	IN 05	IN 06	IN 07	IN 08	IN 09	OUT 00	OUT 01	OUT 02	OUT 03	OUT 04	OUT 05
Address		2960										2961					
Bit		0	1	2	3	4	5	6	7	8	9	0	1	2	3	4	5
Inputs	Normal inputs	Normal input 0	Normal input 1	Normal input 2	Normal input 3	Normal input 4	Normal input 5	Normal input 6	Normal input 7	Normal input 8	Normal input 9	---	---	---	---	---	---
	Interrupt inputs (Direct Mode/Counter Mode)	Interrupt input 0	Interrupt input 1	Interrupt input 2	Interrupt input 3	---	---	---	---	---	---	---	---	---	---	---	---
	Quick response inputs	Quick response input 0	Quick response input 1	Quick response input 2	Quick response input 3	---	---	---	---	---	---	---	---	---	---	---	---
	High-speed counters	---	---	Highspeed counter 1 (phase-Z/ reset)	Highspeed counter 0 (phase-Z/ reset)	---	---	High-speed counter 1 (phase-A, increment, or count input)	High-speed counter 1 (phase-B, decrement, or direction input)	High-speed counter 0 (phase-A, increment, or count input)	High-speed counter 0 (phase-B, decrement, or direction input)	---	---	---	---	---	---
Outputs	Normal outputs	---	---	---	---	---	---	---	---	---	---	Normal output 0	Normal output 1	Normal output 2	Normal output 3	Normal output 4	Normal output 5
	Pulse outputs	CW/CCW outputs	---	---	---	---	---	---	---	---	---	Pulse output 0 (CW)	Pulse output 0 (CCW)	Pulse output 1 (CW)	Pulse output 1 (CCW)	---	---
		Pulse + direction outputs	---	---	---	---	---	---	---	---	---	Pulse output 0 (pulse)	Pulse output 1 (pulse)	Pulse output 0 (direction)	Pulse output 1 (direction)	---	---
		Variable duty ratio outputs	---	---	---	---	---	---	---	---	---	---	---	---	---	---	PWM output 0
Origin search		Origin search 0 (Origin Input Signal)	Origin search 0 (Origin Proximity Input Signal)	Origin search 1 (Origin Input Signal)	Origin search 1 (Origin Proximity Input Signal)	Origin search 0 (Positioning Completed Signal)	Origin search 1 (Positioning Completed Signal)	---	---	---	---	---	---	---	---	Pulse output 0 error counter reset output (operation modes 1 and 2)	Pulse output 1 error counter reset output (operation modes 1 and 2)

### Pulse I/O Module 1 (on the left)

Terminal symbol		IN 10	IN 11	IN 12	IN 13	IN 14	IN 15	IN 16	IN 17	IN 18	IN 19	OUT 10	OUT 11	OUT 12	OUT 13	OUT 14	OUT 15
Address		2962										2963					
Bit		0	1	2	3	4	5	6	7	8	9	0	1	2	3	4	5
Inputs	Normal inputs	Normal input 10	Normal input 11	Normal input 12	Normal input 13	Normal input 14	Normal input 15	Normal input 16	Normal input 17	Normal input 18	Normal input 19	---	---	---	---	---	---
	Interrupt inputs (Direct Mode/Counter Mode)	Interrupt input 4	Interrupt input 5	Interrupt input 6	Interrupt input 7	---	---	---	---	---	---	---	---	---	---	---	---
	Quick response inputs	Quick response input 4	Quick response input 5	Quick response input 6	Quick response input 7	---	---	---	---	---	---	---	---	---	---	---	---
	High-speed counters	---	---	Highspeed counter 3 (phase-Z/ reset)	Highspeed counter 2 (phase-Z/ reset)	---	---	High-speed counter 3 (phase-A, increment, or count input)	High-speed counter 3 (phase-B, decrement, or direction input)	High-speed counter 2 (phase-A, increment, or count input)	High-speed counter 2 (phase-B, decrement, or direction input)	---	---	---	---	---	---
Outputs	Normal outputs	---	---	---	---	---	---	---	---	---	---	Normal output 6	Normal output 7	Normal output 8	Normal output 9	Normal output 10	Normal output 11
	Pulse outputs	CW/CCW outputs	---	---	---	---	---	---	---	---	---	Pulse output 2 (CW)	Pulse output 2 (CCW)	Pulse output 3 (CW)	Pulse output 3 (CCW)	---	---
		Pulse + direction outputs	---	---	---	---	---	---	---	---	---	Pulse output 2 (pulse)	Pulse output 3 (pulse)	Pulse output 2 (direction)	Pulse output 3 (direction)	---	---
		Variable duty ratio outputs	---	---	---	---	---	---	---	---	---	---	---	---	---	---	PWM output 2
Origin search		Origin search 2 (Origin Input Signal)	Origin search 2 (Origin Proximity Input Signal)	Origin search 3 (Origin Input Signal)	Origin search 3 (Origin Proximity Input Signal)	Origin search 2 (Positioning Completed Signal)	Origin search 3 (Positioning Completed Signal)	---	---	---	---	---	---	---	---	Pulse output 2 error counter reset output (operation modes 1 and 2)	Pulse output 3 error counter reset output (operation modes 1 and 2)

## Specifications of Pulse Input Functions

### Interrupt Inputs

Item	Direct Mode	Counter Mode
Number of interrupt inputs	Max. 8 inputs	
Allocated bit	CIO 2960 and CIO 2962, bits 00 to 03	
Interrupt detection method	ON-to-OFF or OFF-to-ON transitions	
Interrupt task numbers	140 to 147 (fixed)	
Counting method	---	Incrementing or decrementing (Set with the MSKS(690) instruction.)
Counting range	---	0001 to FFFF hex (16 bits) (Set in A532 to A535 and A544 to A547.)
Response frequency	---	Single-phase: 3 kHz x 8 inputs
Storage locations for PVs for interrupt inputs in Counter Mode	---	A536 to A539 and A548 to A551

### Quick-response inputs

Item	Specifications
Number of Quick-response inputs	Max. 8 inputs
Quick-response inputs	Signals that are shorter than the cycle time are latched for one PLC cycle, so they can be detected in the PLC program. Minimum detectable pulse width is 30 $\mu$ s.

### High-speed Counter Inputs

Item	Description
Number of High-speed Counter Inputs	Max. 4 inputs
Pulse input method (counting mode)	Incremental pulse inputs    Differential phase input (4 $\times$ )    Up/down inputs    Pulse + direction inputs
Input signals	Increment pulse    Phase A    Up pulse    Pulse
	---    Phase B    Down pulse    Direction
	---    Phase Z    Reset    Reset
Frequency and number of high-speed counters	100 kHz, 2 inputs $\times$ 2 I/O Modules    50 kHz, 2 inputs $\times$ 2 I/O Modules    100 kHz, 2 inputs $\times$ 2 I/O Modules    100 kHz, 2 inputs $\times$ 2 I/O Modules
Counting mode	Linear mode or ring mode
Count value	Linear mode:    8000 0000 to 7FFF FFFF hex 0000 0000 to FFFF FFFF hex (for increment pulse) Ring mode:    0000 0000 to Max. ring value
High-speed counter PV storage locations	High-speed counter 0: A271 (upper 4 digits) and A270 (lower 4 digits) High-speed counter 1: A273 (upper 4 digits) and A272 (lower 4 digits) High-speed counter 2: A317 (upper 4 digits) and A316 (lower 4 digits) High-speed counter 3: A319 (upper 4 digits) and A318 (lower 4 digits) Refreshed during overseeing processing. Use PRV(881) to read the most recent PVs.  Data format: 8 digit hexadecimal • Linear mode:    8000 0000 to 7FFF FFFF hex 0000 0000 to FFFF FFFF hex (for increment pulse) • Ring mode:    0000 0000 to Max. ring value
Control method	Target value comparison    Up to 48 target values and corresponding interrupt task numbers can be registered.
	Range Comparison    Up to 8 or up to 32 ranges can be registered, with a separate upper limit, lower limit, and interrupt task number for each range.
Counter reset method	<ul style="list-style-type: none"> <li>Phase-Z + Software reset The counter is reset when the phase-Z input goes ON while the Reset Bit (A531.00 to A531.03) is ON.</li> <li>Software reset The counter is reset when the Reset Bit (A531.00 to A531.03) is turned ON. Operation can be set to stop or continue the comparison operation when the high-speed counter is reset.</li> </ul>

## Specifications of Pulse Output Functions

### Position Control and Speed Control

Item	Specifications
Number of Pulse Outputs	Max. 4 outputs (Pulse Output 00 to 03)
Output mode	Continuous mode (for speed control) or independent mode (for position control)
Positioning (independent mode) instructions	PULS (886) and SPED (885), PULS (886) and ACC (888), or PULS2 (887) instruction
Speed control (continuous mode) instructions	SPED (885) and ACC (888) instructions
Origin (origin search and origin return) instructions	ORG (889) instruction
Interrupt feeding instruction	IFEED (892) instruction
Output frequency	1 pps to 100 kpps (1 pps units), two pulse outputs × 2 Pulse I/O Modules
Frequency acceleration and deceleration rates	Set in increments of 1 pps for acceleration/deceleration rates from 1 to 65,535 pps (every 4 ms). The acceleration and deceleration rates can be set independently only with the PLS2 (887) instruction.
Changing SVs during instruction execution	The target frequency, acceleration/deceleration rate, and target position can be changed.
Pulse output method	CW/CCW or pulse + direction
Number of output pulses	Relative coordinates: 0000 0000 to 7FFF FFFF hex (Accelerating or decelerating in either direction: 2,147,483,647) Absolute coordinates: 8000 0000 to 7FFF FFFF hex (-2,147,483,648 to 2,147,483,647)
Relative/absolute coordinate specifications for pulse output PVs	Absolute coordinates are specified automatically when the origin location has been defined by changing the pulse output PV with the INI (880) instruction or performing an origin search with the ORG(889) instruction. Relative coordinates must be used when the origin is undefined.
Relative pulse/absolute pulse specifications	The pulse type can be specified with an operand in the PULS (886) or PLS2 (887) instruction. Absolute pulses can be used when absolute coordinates are specified for the pulse output PV, i.e. the origin location has been defined. Absolute pulse cannot be used when relative coordinates are specified, i.e., when the origin location is undefined. An instruction error will occur.
Pulse output PV's storage location	The following Auxiliary Area words contain the pulse output PVs Pulse output 0: A277 (leftmost 4 digits) and A276 (rightmost 4 digits) Pulse output 1: A279 (leftmost 4 digits) and A278 (rightmost 4 digits) Pulse output 2: A323 (leftmost 4 digits) and A322 (rightmost 4 digits) Pulse output 3: A325 (leftmost 4 digits) and A324 (rightmost 4 digits) The PVs are refreshed during regular I/O refreshing.

### Variable-duty Pulse Outputs (PWM)

Item	Specifications
Number of PWM Outputs	Max. 4 outputs (PWM Output 00 to 03)
Duty ratio	0.0% to 100.0% in 0.1% increments
Frequency	0.1 Hz to 6,553.5 Hz (Set in 0.1-Hz increments.) 1 Hz to 32,800 Hz (Set in 1-Hz increments.)
Output mode	Continuous Mode
Instruction	PWM (891) instruction



## Specifications of Pulse I/O Modules

### Input Specifications (IN00 to IN09/IN10 to IN19)

#### Normal Inputs

Inputs	IN00 to IN05 and IN10 to IN15	IN06 to IN09 and IN16 to IN19	IN00 to IN05 and IN10 to IN15	IN06 to IN09 and IN16 to IN19
Input form	24 VDC inputs		Line driver inputs	
Input current	6.0 mA typical	5.5 mA typical	13 mA typical	10 mA typical
Input voltage range	24 VDC +10%/−15%		RS-422A or RS-422 line driver (conforming to AM26LS31), Power supply voltage of 5 V ±5%	
Input impedance	3.6 kΩ	4.0 kΩ	---	
Number of circuits	1 common, 1 circuit			
ON voltage/current	17.4 VDC min., 3 mA min.		---	
OFF voltage/current	1 mA max. at 5 VDC max.		---	
ON response time	8 ms max. (The input time constant can be set to 0, 0.5, 1, 2, 4, 8, 16, or 32 ms in the PLC Setup.)			
OFF response time	8 ms max. (The input time constant can be set to 0, 0.5, 1, 2, 4, 8, 16, or 32 ms in the PLC Setup.)			

#### Input Circuit Configuration

Item	Specifications	
Input	IN00 to IN05/IN10 to IN15	IN06 to IN09/IN16 to IN19
Circuit configuration		

#### Interrupt Input and Quick-response Input Specifications (IN00 to IN03 and IN10 to IN13)

Item	Specifications
ON response time	30 μs max.
OFF response time	150 μs max.
Response pulse	

High-speed Counter Input Specifications (IN06 to IN09 and IN16 to IN19)

	24-VDC input	Line driver input
Set to 60 kHz	<p>Phase-A/Phase-B encoder input, Single-phase 60-kHz pulse input with 50% duty ratio</p> <p>Rise time and fall time: 3.0 μs max. 16.6 μs min.</p> <p>ON 50% OFF</p> <p>8.3 μs min. 8.3 μs min.</p> <p>3 μs max. 3 μs max.</p>	<p>Encoder input phase A or B, single-phase 60-kHz pulse input with 50% duty ratio</p> <p>ON 50% OFF</p> <p>16.6 μs min.</p> <p>8.3 μs min. 8.3 μs min.</p>
	<p>Phase-A/Phase-B encoder inputs, Differential phases, 30 kHz</p> <p>Changes in phases A and B must be separated by at least 4.0 μs.</p> <p>ON 50% OFF ON 50% OFF</p> <p>33.3 μs min.</p> <p>T1 T2 T3 T4 T1, T2, T3, T4: 4.0 μs min.</p>	<p>Phase-A/Phase-B encoder inputs, Differential phases, 30 kHz</p> <p>Changes in phases A and B must be separated by at least 4.0 μs.</p> <p>ON 50% OFF ON 50% OFF</p> <p>33.3 μs min.</p> <p>T1 T2 T3 T4 T1, T2, T3, T4: 4.0 μs min.</p>
Set to 100 kHz	<p>Phase-A/Phase-B encoder input, Single-phase 100-kHz pulse input with 50% duty ratio</p> <p>Rise time and fall time: 2.5 μs max. 10.0 μs min.</p> <p>ON 50% OFF</p> <p>10.0 μs min.</p> <p>5.0 μs min. 5.0 μs min.</p> <p>2.5 μs max. 2.5 μs max.</p>	<p>Single-phase 100-kHz pulse input with 50% duty ratio</p> <p>ON 50% OFF</p> <p>10.0 μs min.</p> <p>5.0 μs min. 5.0 μs min.</p>
	<p>Phase-A/Phase-B encoder inputs, Differential phases, 50 kHz</p> <p>Changes in phases A and B must be separated by at least 2.5 μs.</p> <p>ON 50% OFF ON 50% OFF</p> <p>20.0 μs min.</p> <p>T1 T2 T3 T4 T1, T2, T3, T4: 2.5 μs min.</p>	<p>Differential-phase 50-kHz pulse input</p> <p>Changes in phases A and B must be separated by at least 2.5 μs.</p> <p>ON 50% OFF ON 50% OFF</p> <p>20.0 μs min.</p> <p>T1 T2 T3 T4 T1, T2, T3, T4: 2.5 μs min.</p>
Phase Z/reset input	<p>Encoder input phase Z (IN02/IN03 or IN12/IN13)</p> <p>Maintain an ON time of 30 μs min. and an OFF time of 150 μs min.</p> <p>ON 50% OFF</p> <p>30 μs min. 150 μs min.</p>	<p>Encoder input phase Z (IN02/IN03 or IN12/IN13)</p> <p>Maintain an ON time of 30 μs min. and an OFF time of 150 μs min.</p> <p>ON 50% OFF</p> <p>30 μs min. 150 μs min.</p>

**Output Specifications (OUT00 to OUT05 and OUT10 to OUT15)**

Item	Specifications	
Output Specifications	Sinking-type (CJ2M-MD211)	Sourcing-type (CJ2M-MD212)
Rated voltage	5 to 24 VDC	
Allowable voltage range	4.75 to 26.4 VDC	
Maximum switching current	0.3 A/output, 1.8 A/Unit	
Number of circuits	6 outputs (6 outputs/common)	
Maximum inrush current	3.0 A/output, 10 ms max.	2.0 A/output, 10 ms max.
Leakage current	0.1 mA max.	
Residual voltage	0.6 V max.	
ON response time	0.1 ms max.	
OFF response time	0.1 ms max.	
Fuse	None	
External supply power (power supply input for outputs)	10.2 to 26.4 VDC, 20 mA min.	

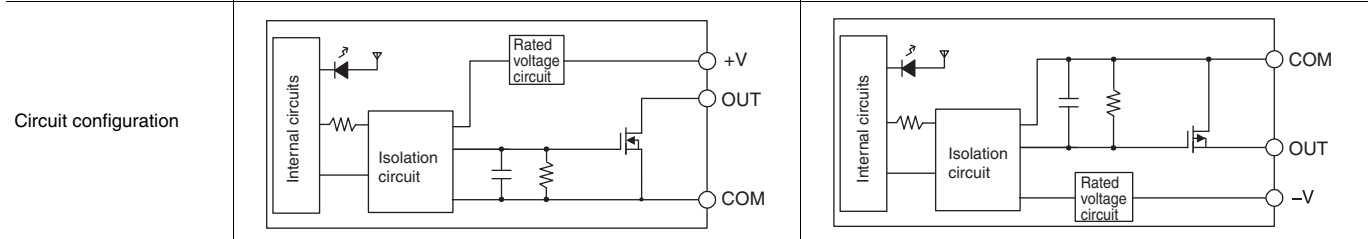

**Pulse Outputs (OUT00 to OUT03 and OUT10 to OUT13)**

Item	Specifications	
Output Specifications	Sinking-type (CJ2M-MD211)	Sourcing-type (CJ2M-MD212)
Rated voltage	5 to 24 VDC	
Allowable voltage range	4.75 to 26.4 VDC	
Maximum switching capacity	30 mA	
Minimum switching capacity	7 mA	
Maximum output frequency	100 kHz	
Output waveform		

**PWM Outputs (OUT04, OUT05, OUT14, and OUT15)**

Item	Specifications	
Output Specifications	Sinking-type (CJ2M-MD211)	Sourcing-type (CJ2M-MD212)
Rated voltage	5 to 24 VDC	
Allowable voltage range	4.75 to 26.4 VDC	
Maximum switching capacity	6.5535 kHz or less: 300 mA, 6.5535 to 32.8 kHz: 100 mA	
Maximum output frequency	32,800 Hz	
PWM output accuracy (for ON pulse width of 2 μs or longer)	ON duty at 6.5535 kHz or less: -0.2% to +1%, ON duty at 32.8 kHz: -1% to +5% (at switching current of 30 mA)	ON duty at 6.5535 kHz or less: ±0.5%, ON duty at 32.8 kHz: +2.5% (at switching current of 30 mA)
Output waveform		

## Unit Versions

Units	Models	Unit version
CJ2M CPU Units	CJ2M-CPU3□	CPU: Unit version 1.0 (Built-in EtherNet/IP section: Unit version 2.0)
		CPU: Unit version 2.0 (Built-in EtherNet/IP section: Unit version 2.0)
		CPU: Unit version 2.0 (Built-in EtherNet/IP section: Unit version 2.1)
	CJ2M-CPU1□	CPU: Unit version 1.0
		CPU: Unit version 2.0

## Function Support by Unit Version

### Functions Supported for Unit Version 2.0 or Later

The following tables show the relationship between unit versions and CX-Programmer versions.

CPU Unit	CJ2M CPU Unit	
Model	CJ2M-CPU□□	
Unit Version	Unit version 2.0 or higher	Unit version 1.0
Function	OK	–

\* A Pulse I/O Module must be mounted for CJ2M CPU Units with unit version 2.0 or later.

## Unit Versions and Programming Devices

The following tables show the relationship between unit versions and CX-Programmer versions.

### Unit Versions and Programming Devices

CPU Unit	Functions	Required Programming Device			Programming Console
		CX-Programmer			
		Ver. 9.0 or lower	Ver. 9.1 or higher	Ver. 9.12 or higher	
CJ2M-CPU□□ Unit version 1.0	Functions for unit version 1.0	–	OK *1	OK	– *3
CJ2M-CPU□□ Unit version 2.0	Functions added for unit version 2.0	Using new functions	–	OK	
		Not using new functions	–	OK *2	

\*1. CX-Programmer version 9.1 or higher is required to use CJ2M CPU Units.

\*2. It is not necessary to upgrade the version of the CX-Programmer if functionality that was enhanced for the upgrade of the CPU Unit will not be used.

\*3. A Programming Console cannot be used with a CJ2M CPU Unit.

## Device Type Setting

The unit version does not affect the setting made for the device type on the CX-Programmer. Select the device type as shown in the following table regardless of the unit version of the CPU Unit.

Series	CPU Unit group	CPU Unit model	Device type setting on CX-Programmer Ver. 9.1 or higher
CJ Series	CJ2M CPU Units	CJ2M-CPU3□ CJ2M-CPU1□	CJ2M

# External Interface

## CJ2M-CPU3□ (CJ2M with Built-in EtherNet/IP)

A CJ2M-CPU3□ provides two communications ports for external interfaces: a peripheral (USB) port and an EtherNet/IP port. The Pulse I/O functions of the CJ2M can be used by mounting a Pulse I/O Module. Up to two Pulse I/O Modules can be connected to the left side of a CJ2M CPU Unit. Serial ports can be added by mounting a Serial Communications Option Board (sold separately) in an option slot.

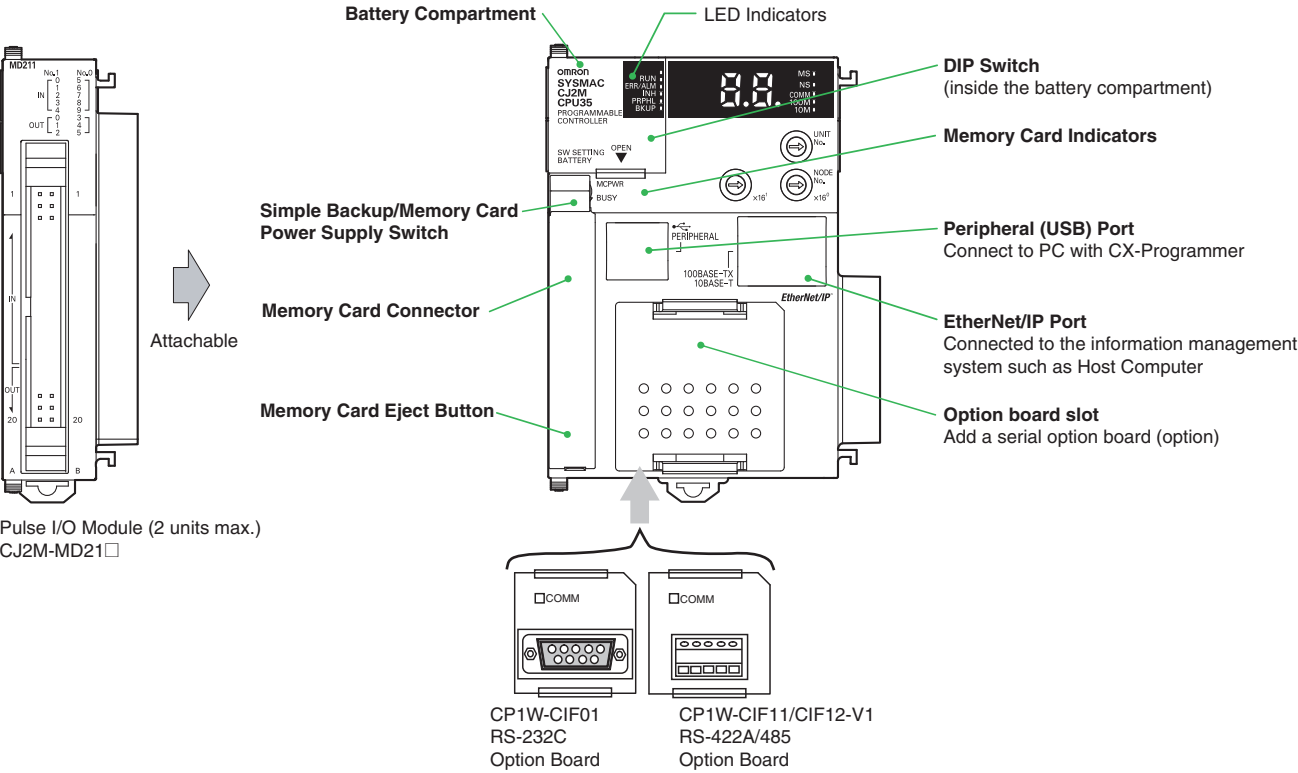

## CJ2M-CPU1□

A CJ2M-CPU1□ provides two communications ports for external interfaces: a peripheral (USB) port and a serial port. The Pulse I/O of the CJ2M can be used by mounting a Pulse I/O Module. Up to two Pulse I/O Modules can be connected to the left side of a CJ2M CPU Unit.

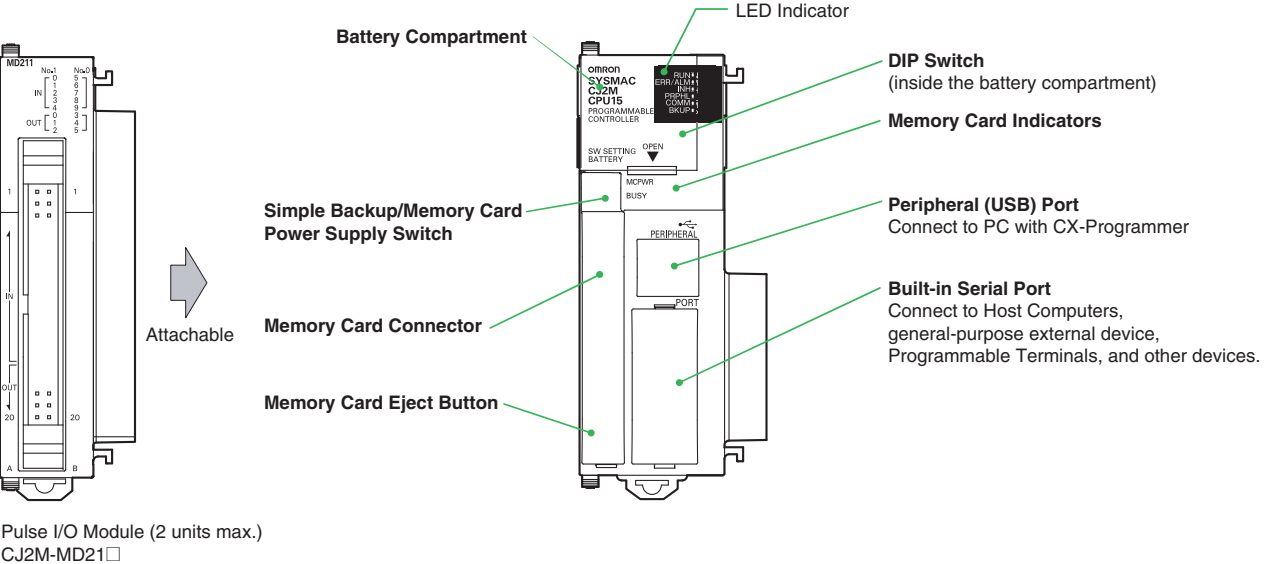

**Peripheral (USB) Port**

Item	Specification
Baud Rate	12 Mbps max.
Transmission Distance	5 m max.
Interface	USB 2.0-compliant B-type connector
Protocol	Peripheral Bus

**EtherNet/IP Port**

Item	Specification
Media Access Method	CSMA/CD
Modulation	Baseband
Transmission Paths	Star
Baud Rate	100 Mbps (100Base-TX)
Transmission Media	Shielded twisted-pair (STP) cable; Categories: 5, 5e
Transmission Distance	100 m (between ethernet switch and node)
Number of Cascade Connections	No restrictions if ethernet switch is used.
Communications	CIP Communications (tag data links, Explicit Messages). FINS communications

**Built-in Serial Port (Only CJ2M-CPU1□)**

Item	Specification
Communications method	Half duplex
Synchronization	Start-stop
Baud rate	0.3/0.6/1.2/2.4/4.8/9.6/19.2/38.4/57.6/115.2 kbps *
Transmission distance	15 m max.
Interface	EIA RS-232C
Protocol	Host Link, NT Link, 1:N, No-protocol, or Peripheral Bus

\* Baud rates for the RS-232C are specified only up to 19.2 kbps. The CJ Series supports serial communications from 38.4 kbps to 115.2 kbps, but some computers cannot support these speeds. Lower the baud rate if necessary.

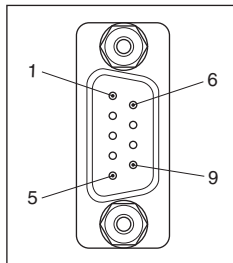

Pin No.	Signal	Name	Direction
1	FG	Protection earth	-
2	SD (TXD)	Send data	Output
3	RD (RXD)	Receive data	Input
4	RS (RTS)	Request to send	Output
5	CS (CTS)	Clear to send	Input
6	5 V	Power supply	-
7	DR (DSR)	Data set ready	Input
8	ER (DTR)	Data terminal ready	Output
9	SG (0 V)	Signal ground	-
Connector hood	FG	Protection earth	-

**Note:** Do not use the 5-V power from pin 6 of the RS-232C port for anything but CJ1W-CIF11 RS-422A Conversion Adapter, NT-AL001 RS-232C/RS-422A Conversion Adapter and NV3W-M\_20L(-V1) Programmable Terminal. The external device or the CPU Unit may be damaged.

**Serial Option Board (Only CJ2M-CPU3□)**

A Serial Option Board can be used with a CJ2M-CPU3□ CJ2M CPU Unit.

Model	Port	Maximum transmission distance	Connection method
CP1W-CIF01	One RS-232C port	15 m	Connector: D-sub, 9-pin female
CP1W-CIF11	One RS-422A/485 port (not isolated)	50 m	Terminal block: Using ferrules
CP1W-CIF12-V1	One RS-422A/485 port (isolated)	500 m	Terminal block: Using ferrules

**CP1W-CIF01 RS-232C Option Board**

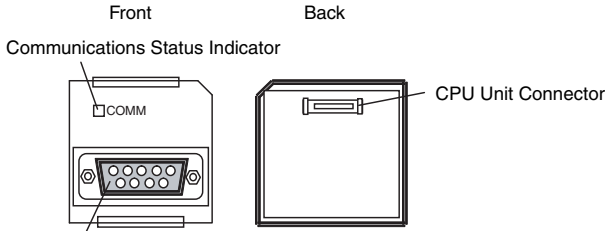

RS-232 Connector

**●RS-232C Connector**

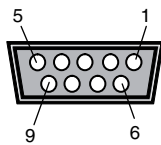

Pin No.	Signal	Name	Direction
1	FG	Protection earth	-
2	SD (TXD)	Send data	Output
3	RD (RXD)	Receive data	Input
4	RS (RTS)	Request to send	Output
5	CS (CTS)	Clear to send	Input
6	5 V	Power supply	-
7	DR (DSR)	Data set ready	Input
8	ER (DTR)	Data terminal ready	Output
9	SG (0 V)	Signal ground	-
Connector hood	FG	Protection earth	-

**Note:** Do not use the 5-V power from pin 6 of the RS-232C port for anything but CJ1W-CIF11 RS-422A Conversion Adapter, NT-AL001 RS-232C/RS-422A Conversion Adapter and NV3W-M\_20L(-V1) Programmable Terminal. The external device or the CPU Unit may be damaged.

**CP1W-CIF11/CIF12-V1 RS-422A/485 Option Board**

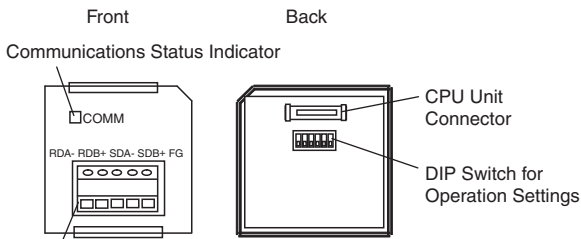

RS-422A/485 Connector

**●RS-422A/485 Terminal Block**

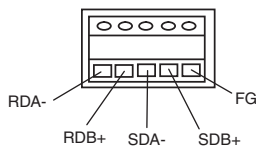

Tighten the terminal block screws to a torque of 0.28 N·m.

## Connector Pin Allocations of Pulse I/O Module (40 pins)

### Connector on Sinking-type I/O Module (CJ2M-MD211)

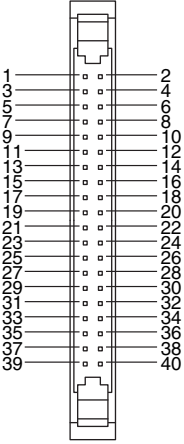
Pin layout	Terminal symbol	Input signal type	Pin	*	Terminal symbol	Input signal type	Pin	*
	IN00/IN10	24 VDC	1	A1	IN01/IN11	24 VDC	2	B1
		LD+	3	A2		LD+	4	B2
		0 V/LD-	5	A3		0 V/LD-	6	B3
	IN02/IN12	24 VDC	7	A4	IN03/IN13	24 VDC	8	B4
		LD+	9	A5		LD+	10	B5
		0 V/LD-	11	A6		0 V/LD-	12	B6
	IN04/IN14	24 VDC	13	A7	IN05/IN15	24 VDC	14	B7
		LD+	15	A8		LD+	16	B8
		0 V/LD-	17	A9		0 V/LD-	18	B9
	IN06/IN16	24 VDC	19	A10	IN07/IN17	24 VDC	20	B10
		LD+	21	A11		LD+	22	B11
		0 V/LD-	23	A12		0 V/LD-	24	B12
	IN08/IN18	24 VDC	25	A13	IN09/IN19	24 VDC	26	B13
		LD+	27	A14		LD+	28	B14
		0 V/LD-	29	A15		0 V/LD-	30	B15
	OUT00/OUT10	---	31	A16	OUT01/OUT11	---	32	B16
	OUT02/OUT12	---	33	A17	OUT03/OUT13	---	34	B17
	OUT04/OUT14	---	35	A18	OUT05/OUT15	---	36	B18
	Power supply input +V for outputs	---	37	A19	Power supply input +V for outputs	---	38	B19
	COM	---	39	A20	COM	---	40	B20

\* Terminals numbers on the XW2R-□40G-T Connector-Terminal Block Conversion Unit.

### Sourcing-type I/O Module (CJ2M-MD212)

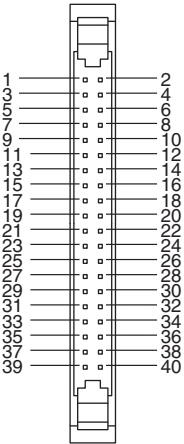
Pin layout	Terminal symbol	Input signal type	Pin	*	Terminal symbol	Input signal type	Pin	*
	IN00/IN10	24 VDC	1	A1	IN01/IN11	24 VDC	2	B1
		LD+	3	A2		LD+	4	B2
		0 V/LD-	5	A3		0 V/LD-	6	B3
	IN02/IN12	24 VDC	7	A4	IN03/IN13	24 VDC	8	B4
		LD+	9	A5		LD+	10	B5
		0 V/LD-	11	A6		0 V/LD-	12	B6
	IN04/IN14	24 VDC	13	A7	IN05/IN15	24 VDC	14	B7
		LD+	15	A8		LD+	16	B8
		0 V/LD-	17	A9		0 V/LD-	18	B9
	IN06/IN16	24 VDC	19	A10	IN07/IN17	24 VDC	20	B10
		LD+	21	A11		LD+	22	B11
		0 V/LD-	23	A12		0 V/LD-	24	B12
	IN08/IN18	24 VDC	25	A13	IN09/IN19	24 VDC	26	B13
		LD+	27	A14		LD+	28	B14
		0 V/LD-	29	A15		0 V/LD-	30	B15
	OUT00/OUT10	---	31	A16	OUT01/OUT11	---	32	B16
	OUT02/OUT12	---	33	A17	OUT03/OUT13	---	34	B17
	OUT04/OUT14	---	35	A18	OUT05/OUT15	---	36	B18
	COM	---	37	A19	COM	---	38	B19
	Power supply input -V for outputs	---	39	A20	Power supply input -V for outputs	---	40	B20

\* Terminals numbers on the XW2R-□40G-T Connector-Terminal Block Conversion Unit.



## Pulse I/O Module MIL connector Wiring Methods

To connect to a Terminal Block, use an OMRON Cable preassembled with the special connector or attach the special connector (sold separately) to a cable yourself.

### Using User-made Cables with Connector

#### Connector Models

#### Compatible Connector Specifications

- MIL Flat Cable Connectors (40-pin Pressure-fitted Connectors)

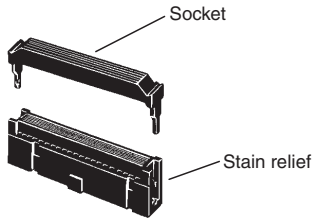

Name	OMRON model number
Socket	XG4M-4030
Stain Relief	XG4M-4004
Set model number	XG4M-4030-T
Recommended Flat Cable	XY3A-200□

- MIL Loose Wire Crimp Connectors (40-pin Pressure-fitted Connectors)

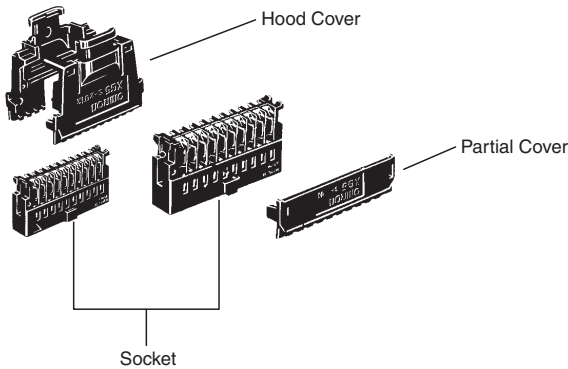

Name	OMRON model number	
Socket	AWG24	XG5M-4032-N
	AWG26 to AWG28	XG5M-4035-N
Spare Contacts (See note 1.)	AWG24	XG5W-0031-N
	AWG26 to AWG28	XG5W-0034-N
Hood Cover (See note 2.)	XG5S-4022	
Partial Cover (See note 2.) (2 required for each socket)	XG5S-2001	

- Note: 1.** Contacts are included with the Socket.  
**2.** Select either the Hood Cover or the Partial Cover.

### Wiring

We recommend using a cable with wires sized between 28 and 24 AWG (0.2 to 0.08 mm<sup>2</sup>). Use a wire with an outer diameter of 1.61 mm max.

### Compatible Terminal Blocks

Recommended Cable	Compatible Terminal Block	Wiring method	Number of terminals	Temperature (°C)
XW2Z-□□□K	XW2R-J40G-T	Phillips screw	40	0 to 55
	XW2R-E40G-T	Slotted screw (rise up)		
	XW2R-P40G-T	Push-in spring		

## Using preassembled cables and terminal blocks.

### Connection of Pulse I/O module to a General-purpose Terminal Block

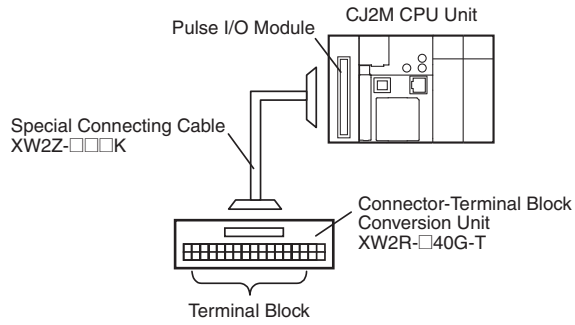

### Connection of Pulse I/O module to a Servo Drive Terminal Block

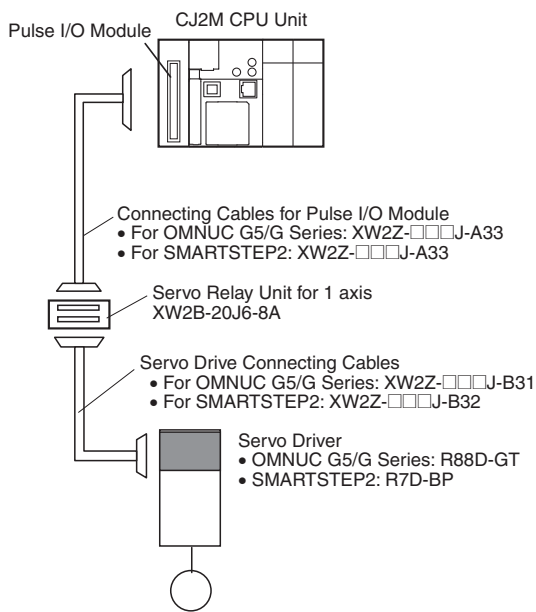

# Dimensions

(Unit: mm)

## CJ2M-CPU3□

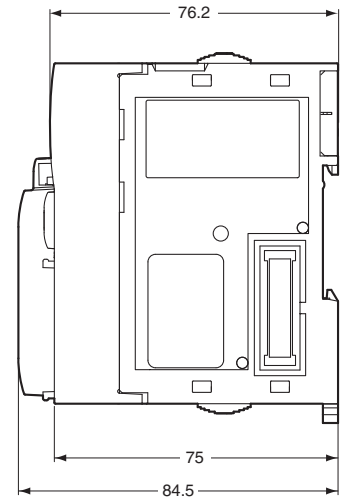
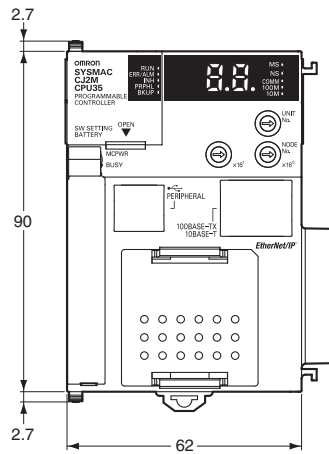

## CJ2M-CPU1□

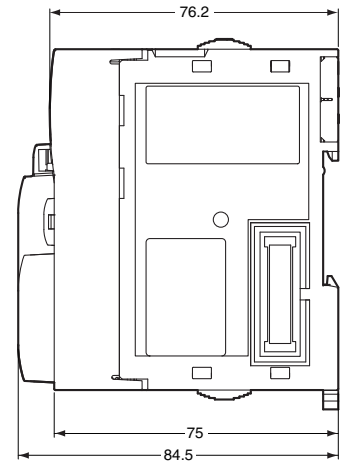
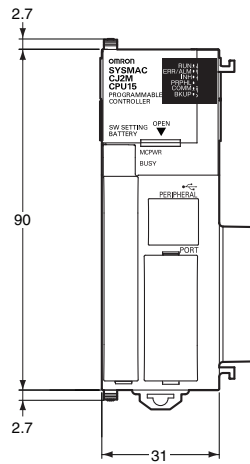

## CJ2M-MD211/MD212

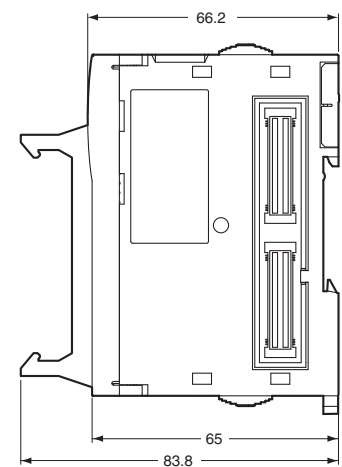
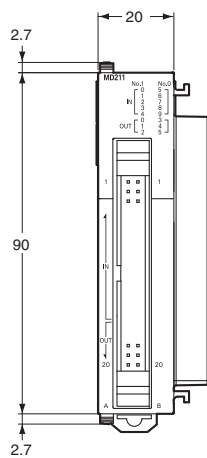

## Related Manuals

Cat. No.	Model	Manual	Application	Description
W472	CJ2H-CPU6□-EIP CJ2H-CPU6□ CJ2M-CPU□□	CJ-series CJ2 CPU Unit Hardware User's Manual	Hardware specifications for CJ2 CPU Units	Describes the following for CJ2 CPU Units: <ul style="list-style-type: none"> <li>• Overview and features</li> <li>• Basic system configuration</li> <li>• Part nomenclature and functions</li> <li>• Mounting and setting procedure</li> <li>• Remedies for errors</li> <li>• Also refer to the <i>Software User's Manual (W473)</i>.</li> </ul>
W473	CJ2H-CPU6□-EIP CJ2H-CPU6□ CJ2M-CPU□□	CJ-series CJ2 CPU Unit Software User's Manual	Software specifications for CJ2 CPU Units	Describes the following for CJ2 CPU Units: <ul style="list-style-type: none"> <li>• CPU Unit operation</li> <li>• Internal memory</li> <li>• Programming</li> <li>• Settings</li> <li>• Functions built into the CPU Unit</li> </ul> Also refer to the <i>Hardware User's Manual (W472)</i>
W486	CJ2M-CPU□□ + CJ2M-MD21□	CJ-series CJ2M CPU Unit Pulse I/O Module User's Manual	Information on using Pulse I/O on CJ2M CPU Units	Provides the following information on the CJ2M CPU Units: <ul style="list-style-type: none"> <li>• Specifications and wiring methods</li> <li>• I/O functions</li> <li>• Quick-response inputs</li> <li>• Interrupt functions</li> <li>• High-speed counters</li> <li>• Pulse outputs</li> <li>• PWM outputs</li> </ul> When programming, use this manual together with the <i>Instructions Reference Manual (Cat. No. W474)</i> .
W474	CJ2H-CPU6□-EIP CJ2H-CPU6□ CJ2M-CPU3□ CJ2M-CPU1□ CS1G/H-CPU□□H CS1G/H-CPU□□-V1 CJ1G/H-CPU□□H CJ1G-CPU□□ CJ1M-CPU□□ NSJ□-□□□□(□)-□□□□	CS/CJ/NSJ-series Instructions Reference Manual	Information on instructions	Describes each programming instruction in detail. Also refer to the <i>Software User's Manual (W473)</i> when you do programming.
W342	CJ2H-CPU6□-EIP CJ2H-CPU6□ CJ2M-CPU□□ CS1G/H-CPU□□H CS1G/H-CPU□□-V1 CS1D-CPU□□H CS1D-CPU□□S CS1W-SCU□□-V1 CS1W-SCB□□-V1 CJ1H-CPU□□H-R CJ1G/H-CPU□□H CJ1G-CPU□□P CJ1M-CPU□□ CJ1G-CPU□□ CJ1W-SCU□□-V1 CP1H-X□□□□-□ CP1H-XA□□□□-□ CP1H-Y□□□□-□ CP1E-E/N□□D□-□ NSJ□-□□□□(□)-□□□□	CS/CJ/CP/NSJ-series Communications Command Reference Manual	Information on communications for CS/CJ/CP-series CPU Units and NSJ-series Controllers	Describes C-mode commands and FINS commands Refer to this manual for a detailed description of commands for communications with the CPU Unit using C mode commands or FINS commands. <b>Note:</b> This manual describes the communications commands that are addressed to CPU Units. The communications path that is used is not relevant and can include any of the following: serial ports on CPU Units, communications ports on Serial Communications Units/Boards, and Communications Units. For communications commands addressed to Special I/O Units or CPU Bus Units, refer to the operation manual for the related Unit.
W465	CJ2H-CPU6□-EIP CJ2M-CPU3□ CS1W-EIP21 CJ1W-EIP21	CS and CJ Series EtherNet/IP Units CS1W-EIP21, CJ1W- EIP21, CJ2H-CPU6□- EIP, CJ2M-CPU3□ Operation Manual	Information for EtherNet/IP function of CJ2M built-in Ethernet port	Describes EtherNet/IP port/units. A basic setting, a tag data link, FINS communication, and other function are described.
W463	CXONE-AL□□D-V□	CX-One Setup Manual	Installing software from the CX- One	Provides an overview of the CX-One FA Integrated Tool Package and describes the installation procedure.
W446		CX-Programmer Operation Manual		
W447	WS02-CXPC□-V□	CX-Programmer Operation Manual Functions Blocks/ Structured Text	Support Software for Windows computers	Describes operating procedures for the CX-Programmer. Also refer to the <i>Software User's Manual (W473)</i> and <i>Instructions Reference Manual (W474)</i> when you do programming.
W469		CX-Programmer Operation Manual SFC Programming	CX-Programmer operating procedure	
W366	WS02-SIMC1-E	CS/CJ/CP/NSJ-series CX-Simulator Operation Manual	Operating procedures for CX- Simulator Simulation Support Software for Windows computers Using simulation in the CX- Programmer with CX- Programmer version 6.1 or higher	Describes the operating procedures for the CX-Simulator. When you do simulation, also refer to the <i>CX-Programmer Operation Manual (W446)</i> , <i>Software User's Manual (W473)</i> , and <i>CS/CJ/NSJ series Instructions Reference Manual (W474)</i> .
W464	CXONE-AL□□D-V□	CS/CJ/CP/NSJ-series CX-Integrator Network Configuration Software Operation Manual	Network setup and monitoring	Describes the operating procedures for the CX-Integrator.

## Terms and Conditions Agreement

### Read and understand this catalog.

Please read and understand this catalog before purchasing the products. Please consult your OMRON representative if you have any questions or comments.

### Warranties.

(a) Exclusive Warranty. Omron's exclusive warranty is that the Products will be free from defects in materials and workmanship for a period of twelve months from the date of sale by Omron (or such other period expressed in writing by Omron). Omron disclaims all other warranties, express or implied.

(b) Limitations. OMRON MAKES NO WARRANTY OR REPRESENTATION, EXPRESS OR IMPLIED, ABOUT NON-INFRINGEMENT, MERCHANTABILITY OR FITNESS FOR A PARTICULAR PURPOSE OF THE PRODUCTS. BUYER ACKNOWLEDGES THAT IT ALONE HAS DETERMINED THAT THE PRODUCTS WILL SUITABLY MEET THE REQUIREMENTS OF THEIR INTENDED USE.

Omron further disclaims all warranties and responsibility of any type for claims or expenses based on infringement by the Products or otherwise of any intellectual property right. (c) Buyer Remedy. Omron's sole obligation hereunder shall be, at Omron's election, to (i) replace (in the form originally shipped with Buyer responsible for labor charges for removal or replacement thereof) the non-complying Product, (ii) repair the non-complying Product, or (iii) repay or credit Buyer an amount equal to the purchase price of the non-complying Product; provided that in no event shall Omron be responsible for warranty, repair, indemnity or any other claims or expenses regarding the Products unless Omron's analysis confirms that the Products were properly handled, stored, installed and maintained and not subject to contamination, abuse, misuse or inappropriate modification. Return of any Products by Buyer must be approved in writing by Omron before shipment. Omron Companies shall not be liable for the suitability or unsuitability or the results from the use of Products in combination with any electrical or electronic components, circuits, system assemblies or any other materials or substances or environments. Any advice, recommendations or information given orally or in writing, are not to be construed as an amendment or addition to the above warranty.

See <http://www.omron.com/global/> or contact your Omron representative for published information.

### Limitation on Liability: Etc.

OMRON COMPANIES SHALL NOT BE LIABLE FOR SPECIAL, INDIRECT, INCIDENTAL, OR CONSEQUENTIAL DAMAGES, LOSS OF PROFITS OR PRODUCTION OR COMMERCIAL LOSS IN ANY WAY CONNECTED WITH THE PRODUCTS, WHETHER SUCH CLAIM IS BASED IN CONTRACT, WARRANTY, NEGLIGENCE OR STRICT LIABILITY.

Further, in no event shall liability of Omron Companies exceed the individual price of the Product on which liability is asserted.

### Suitability of Use.

Omron Companies shall not be responsible for conformity with any standards, codes or regulations which apply to the combination of the Product in the Buyer's application or use of the Product. At Buyer's request, Omron will provide applicable third party certification documents identifying ratings and limitations of use which apply to the Product. This information by itself is not sufficient for a complete determination of the suitability of the Product in combination with the end product, machine, system, or other application or use. Buyer shall be solely responsible for determining appropriateness of the particular Product with respect to Buyer's application, product or system. Buyer shall take application responsibility in all cases.

NEVER USE THE PRODUCT FOR AN APPLICATION INVOLVING SERIOUS RISK TO LIFE OR PROPERTY OR IN LARGE QUANTITIES WITHOUT ENSURING THAT THE SYSTEM AS A WHOLE HAS BEEN DESIGNED TO ADDRESS THE RISKS, AND THAT THE OMRON PRODUCT(S) IS PROPERLY RATED AND INSTALLED FOR THE INTENDED USE WITHIN THE OVERALL EQUIPMENT OR SYSTEM.

### Programmable Products.

Omron Companies shall not be responsible for the user's programming of a programmable Product, or any consequence thereof.

### Performance Data.

Data presented in Omron Company websites, catalogs and other materials is provided as a guide for the user in determining suitability and does not constitute a warranty. It may represent the result of Omron's test conditions, and the user must correlate it to actual application requirements. Actual performance is subject to the Omron's Warranty and Limitations of Liability.

### Change in Specifications.

Product specifications and accessories may be changed at any time based on improvements and other reasons. It is our practice to change part numbers when published ratings or features are changed, or when significant construction changes are made. However, some specifications of the Product may be changed without any notice. When in doubt, special part numbers may be assigned to fix or establish key specifications for your application. Please consult with your Omron's representative at any time to confirm actual specifications of purchased Product.

### Errors and Omissions.

Information presented by Omron Companies has been checked and is believed to be accurate; however, no responsibility is assumed for clerical, typographical or proofreading errors or omissions.

# Mouser Electronics

Authorized Distributor

Click to View Pricing, Inventory, Delivery & Lifecycle Information:

Omron:

[XW2Z-100J-A27](#) [CJ2M-CPU11](#) [CJ2M-CPU13](#) [CJ2M-CPU31](#) [CJ2M-CPU12](#)



Компания «ЭлектроПласт» предлагает заключение долгосрочных отношений при поставках импортных электронных компонентов на взаимовыгодных условиях!

Наши преимущества:

- Оперативные поставки широкого спектра электронных компонентов отечественного и импортного производства напрямую от производителей и с крупнейших мировых складов;
- Поставка более 17-ти миллионов наименований электронных компонентов;
- Поставка сложных, дефицитных, либо снятых с производства позиций;
- Оперативные сроки поставки под заказ (от 5 рабочих дней);
- Экспресс доставка в любую точку России;
- Техническая поддержка проекта, помощь в подборе аналогов, поставка прототипов;
- Система менеджмента качества сертифицирована по Международному стандарту ISO 9001;
- Лицензия ФСБ на осуществление работ с использованием сведений, составляющих государственную тайну;
- Поставка специализированных компонентов (Xilinx, Altera, Analog Devices, Intersil, Interpoint, Microsemi, Aeroflex, Peregrine, Syfer, Eurofarad, Texas Instrument, Miteq, Cobham, E2V, MA-COM, Hittite, Mini-Circuits, General Dynamics и др.);

Помимо этого, одним из направлений компании «ЭлектроПласт» является направление «Источники питания». Мы предлагаем Вам помощь Конструкторского отдела:

- Подбор оптимального решения, техническое обоснование при выборе компонента;
- Подбор аналогов;
- Консультации по применению компонента;
- Поставка образцов и прототипов;
- Техническая поддержка проекта;
- Защита от снятия компонента с производства.



#### Как с нами связаться

**Телефон:** 8 (812) 309 58 32 (многоканальный)

**Факс:** 8 (812) 320-02-42

**Электронная почта:** [org@eplast1.ru](mailto:org@eplast1.ru)

**Адрес:** 198099, г. Санкт-Петербург, ул. Калинина, дом 2, корпус 4, литера А.