

MAX14784E/MAX14786E/ MAX14787E/MAX14789E

Full-Duplex, $\pm 35\text{kV}$ ESD-Protected, RS-485 Transceivers for High-Speed Communication

General Description

The MAX14784E/MAX14786E/MAX14787E/MAX14789E full-duplex RS-485 transceivers are designed for robust communication in harsh industrial environments. All devices feature $\pm 35\text{kV}$ ESD protection on the RS-485 pins and operate from a 3V to 5.5V supply with a 4mA no-load supply current (max).

The MAX14784E/MAX14787E are optimized for communication over very long cables or short unterminated cables.

The MAX14784E/MAX14786E are available in a 14-pin SO package and operate over the -40°C to $+125^\circ\text{C}$ temperature range. The MAX14786E is also available in a 14-pin TSSOP package.

The MAX14787E/MAX14789E are optimized for space-constrained applications and are available in an 8-pin SO package, operating over the -40°C to $+105^\circ\text{C}$ temperature range.

Applications

- Motion Controllers
- Encoder Interfaces
- HVAC Control Systems
- Utility Meters

Functional Diagram

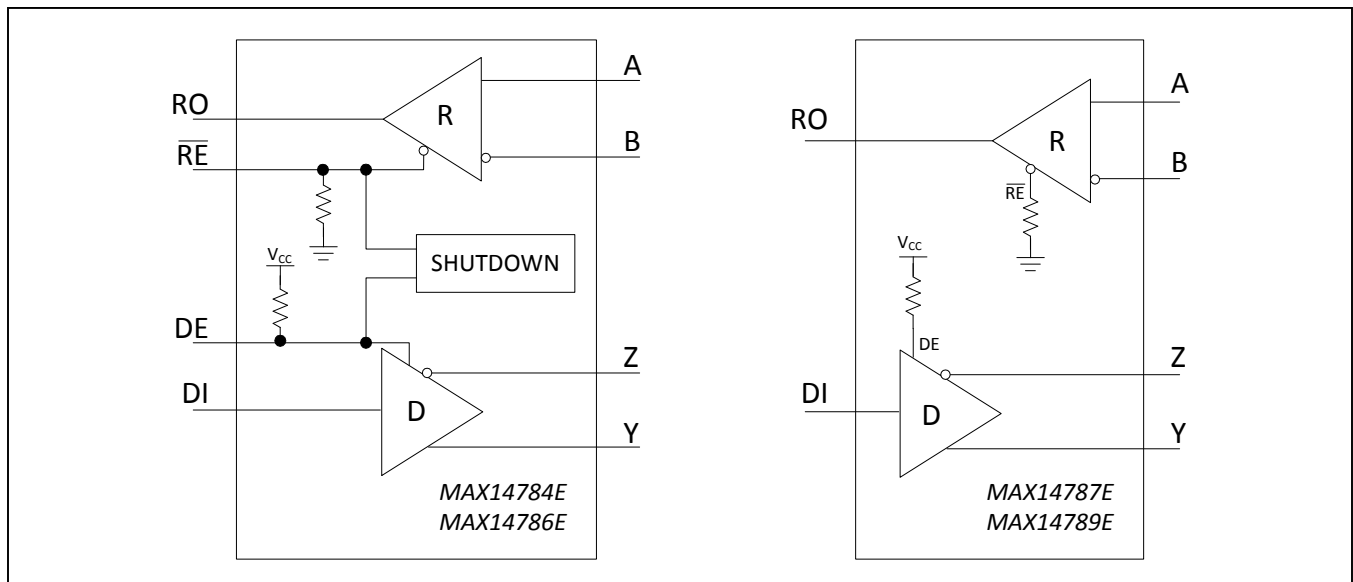

Benefits and Features

- Flexibility
 - Use in Full-Duplex or Half-Duplex Applications
 - Wide 3.0V to 5.5V Supply Voltage Range
 - Available with 500kbps and 25Mbps Speed Options
 - Available in 8-Pin and 14-Pin SO and TSSOP Packages
- Optimized for Performance in Harsh Industrial Environments
 - $\pm 35\text{kV}$ ESD (HBM) Protection on RS-485 I/O Ports
 - Extended Operating Temperature Range
 - Slew-Rate Limited Outputs (MAX14784E/MAX14787E)
 - Integrated Receiver Deglitch Filter Increases Noise Immunity (MAX14784E/MAX14787E/)
 - Short-Circuit Protected Outputs
 - True Fail-Safe Receiver
 - Thermal Shutdown
- 1/4-Unit Load Allows up to 128 Transceivers on the Bus

Ordering Information appears at end of data sheet.

MAX14784E/MAX14786E/
MAX14787E/MAX14789E

Full-Duplex, ±35kV ESD-Protected,
RS-485 Transceivers for
High-Speed Communication

Absolute Maximum Ratings

(All voltages referenced to GND.)

V _{CC}	-0.3V to +6.0V
\overline{RE} , RO	-0.3V to (V _{CC} + 0.3)V
DE, DI	-0.3V to +6.0V
A, B, Y, Z	-8.0V to +13.0V
Short-Circuit Duration	Continuous
Continuous Power Dissipation (T _A = +70°C)	
8 SO (derate 7.6mW/°C above +70°C)	606mW
14 SO (derate 11.9mW/°C above +70°C)	952mW
TSSOP (derate 10mW/°C above +70°C)	796mW

Operating Temperature Range

8 SO	-40°C to +105°C
14 SO	-40°C to +125°C
TSSOP	-40°C to +125°C
Junction Temperature	+150°C
Storage Temperature Range	-65°C to +150°C
Lead Temperature (soldering, 10s)	+300°C
Soldering Temperature (reflow)	+260°C

Stresses beyond those listed under "Absolute Maximum Ratings" may cause permanent damage to the device. These are stress ratings only, and functional operation of the device at these or any other conditions beyond those indicated in the operational sections of the specifications is not implied. Exposure to absolute maximum rating conditions for extended periods may affect device reliability.

Package Thermal Characteristics (Note 1)

Junction-to-Case Thermal Resistance (θ_{JC})

8 SO	38°C/W
14 SO	34°C/W
TSSOP	30°C/W

Junction-to-Ambient Thermal Resistance (θ_{JA})

8 SO	132°C/W
14 SO	84°C/W
TSSOP	30°C/W

Note 1: Package thermal resistances were obtained using the method described in JEDEC specification JESD51-7, using a four-layer board. For detailed information on package thermal considerations, refer to www.maximintegrated.com/thermal-tutorial.

Electrical Characteristics

(V_{CC} = 3.0V to 5.5V, T_A = T_{MIN} to T_{MAX}, unless otherwise noted. Typical values are at V_{CC} = 5V, and T_A = +25°C.) (Notes 2, 3)

PARAMETER	SYMBOL	CONDITIONS	MIN	TYP	MAX	UNITS
POWER SUPPLY						
Supply Voltage	V _{CC}		3.0		5.5	V
Supply Current	I _{CC}	DE = high, \overline{RE} = low, no load		1.9	4	mA
Shutdown Supply Current	I _{SHDN}	DE = low, \overline{RE} = high		5	10	µA
DRIVER						
Differential Driver Output	V _{OD}	R _L = 54Ω, V _{CC} = 4.5V, Figure 1	2.1			V
		R _L = 100Ω, V _{CC} = 3.0V, Figure 1	2.0			
		R _L = 54Ω, V _{CC} = 3.0V, Figure 1	1.5			
Change in Magnitude of Differential Driver Output Voltage	ΔV _{OD}	R _L = 100Ω or 54Ω, Figure 1 (Note 4)			0.2	V
Driver Common-Mode Output Voltage	V _{OC}	R _L = 100Ω or 54Ω, Figure 1 (Note 4)		V _{CC} /2	3	V
Change in Magnitude of Driver Common-Mode Output Voltage	ΔV _{OC}	R _L = 100Ω or 54Ω, Figure 1 (Note 4)			0.2	V
Single-Ended Driver Output Voltage High	V _{OH}	Y and Z outputs, I _{YZ} = -20mA	2.2			V
Single-Ended Driver Output Voltage Low	V _{OL}	Y and Z outputs, I _{YZ} = +20mA			0.8	V
Differential Driver Output Capacitance	C _{OD}	DE = \overline{RE} = high, f = 4MHz		12		pF

MAX14784E/MAX14786E/
MAX14787E/MAX14789E

Full-Duplex, ±35kV ESD-Protected,
RS-485 Transceivers for
High-Speed Communication

Electrical Characteristics (continued)

(V_{CC} = 3.0V to 5.5V, T_A = T_{MIN} to T_{MAX}, unless otherwise noted. Typical values are at V_{CC} = 5V, and T_A = +25°C.) (Notes 2, 3)

PARAMETER	SYMBOL	CONDITIONS	MIN	TYP	MAX	UNITS
Peak Driver Short-Circuit Output Current	I _{OSD}	0V ≤ V _{OUT} ≤ +12V, output low	+40		+250	mA
		-7V ≤ V _{OUT} ≤ V _{CC} , output high	-250		-40	
RECEIVER						
Input Current (A and B)	I _{A,B}	DE = low, V _{CC} = 0V or 3.6V	V _{IN} = +12V		+250	μA
			V _{IN} = -7V	-200		
Differential Input Capacitance	C _{A,B}	Measured between A and B, DE = low, f = 2MHz		12		pF
Receiver Differential Threshold Voltage	V _{TH}	-7V ≤ V _{OUT} ≤ +12V	-200	-120	-10	mV
Receiver Input Hysteresis	ΔV _{TH}	V _{CM} = 0V		20		mV
Receiver Input Resistance	R _{IN}	-7V ≤ V _{CM} ≤ +12V	48			kΩ
LOGIC INTERFACE (DI, DE, RE, RO)						
Input High Voltage	V _{IH}	DE, DI, RE	2.0			V
Input Low Voltage	V _{IL}	DE, DI, RE			0.8	V
Input Current	I _{IN}	DI	-2		+2	μA
RE Pulldown and DE Pullup Input Resistance	R _{IN}			1		MΩ
Receiver Output High Voltage	V _{OH}	RE = low, I _{OUT} = -1mA, (V _A - V _B) > 200mV	V _{CC} - 1.5			V
Receiver Output Low Voltage	V _{OL}	RE = low, I _{OUT} = +1mA, (V _A - V _B) < -200mV			0.4	V
Receiver Output Three-State Current	I _{OZR}	RE = high, 0V ≤ V _{RO} ≤ V _{CC}	-1		+1	μA
Receiver Output Short-Circuit Current	I _{OSR}	RE = low, 0V ≤ V _{RO} ≤ V _{CC}	-95		+95	mA
PROTECTION						
Thermal Shutdown Threshold	T _{SHDN}	Temperature rising		+160		°C
Thermal Shutdown Hysteresis	ΔT _{SHDN}			10		°C
ESD Protection (A, B, Y and Z Pins)		IEC 61000-4-2 Air Gap Discharge to GND		±18		kV
		IEC 61000-4-2 Contact Discharge to GND		±8		
		Human Body Model		±35		
ESD Protection (All Other Pins)		Human Body Model		±2		kV

MAX14784E/MAX14786E/
MAX14787E/MAX14789E

Full-Duplex, ±35kV ESD-Protected,
RS-485 Transceivers for
High-Speed Communication

Switching Characteristics (MAX14784E/MAX14787E)

(V_{CC} = 3.0V to 5.5V, T_A = T_{MIN} to T_{MAX}, unless otherwise noted. Typical values are at V_{CC} = 5V, and T_A = +25°C.) (Notes 2, 5)

PARAMETER	SYMBOL	CONDITIONS	MIN	TYP	MAX	UNITS	
DRIVER							
Driver Propagation Delay	t _{DPLH}	R _L = 54Ω, C _L = 50pF, Figures 2, 3			1000	ns	
	t _{DPHL}				1000		
Differential Driver Output Skew t _{DPLH} - t _{DPHL}	t _{DSKEW}	R _L = 54Ω, C _L = 50pF, Figures 2, 3 (Note 6)			140	ns	
Driver Differential Output Rise or Fall Time	t _{HL} , t _{LH}	R _L = 54Ω, C _L = 50pF, Figures 2, 3			900	ns	
Maximum Data Rate	DR _{MAX}	R _L = 110Ω, C _L = 50pF, Figures 4, 5	500			kbps	
Driver Enable to Output High	t _{DZH}	R _L = 110Ω, C _L = 50pF, Figures 4, 5			2500	ns	
Driver Enable to Output Low	t _{DZL}	R _L = 110Ω, C _L = 50pF, Figures 4, 5			2500	ns	
Driver Disable Time from Low	t _{DLZ}	R _L = 110Ω, C _L = 50pF, Figures 4, 5			100	ns	
Driver Disable Time from High	t _{DHZ}	R _L = 110Ω, C _L = 50pF, Figures 4, 5			100	ns	
Driver Enable from Shutdown to Output High	t _{DZH(SHDN)}	R _L = 110Ω, C _L = 15pF, Figures 4, 5			100	μs	
Driver Enable from Shutdown to Output Low	t _{DZL(SHDN)}	R _L = 110Ω, C _L = 15pF, Figures 4, 5			100	μs	
Time to Shutdown	t _{SHDN}	(Note 7)	50			800	ns
RECEIVER							
Receiver Propagation Delay	t _{RPLH}	C _L = 15pF, Figures 6, 7			200	ns	
	t _{RPHL}				200		
Receiver Output Skew t _{RPLH} - t _{RPHL}	t _{RSKEW}	C _L = 15pF, Figures 6, 7 (Note 6)			30	ns	
Maximum Data Rate	DR _{MAX}		500			kbps	
Receiver Enable to Output High	t _{RZH}	R _L = 1kΩ, C _L = 15pF, Figure 8			30	ns	
Receiver Enable to Output Low	t _{RZL}	R _L = 1kΩ, C _L = 15pF, Figure 8			30	ns	
Receiver Disable Time from Low	t _{RLZ}	R _L = 1kΩ, C _L = 15pF, Figure 8			30	ns	
Receiver Disable Time from High	t _{RHZ}	R _L = 1kΩ, C _L = 15pF, Figure 8			30	ns	
Receiver Enable from Shutdown to Output High	t _{RZH(SHDN)}	R _L = 1kΩ, C _L = 15pF, Figure 8			100	μs	
Receiver Enable from Shutdown to Output Low	t _{RZL(SHDN)}	R _L = 1kΩ, C _L = 15pF, Figure 8			100	μs	
Time to Shutdown	t _{SHDN}	(Note 7)	50			800	ns

MAX14784E/MAX14786E/
MAX14787E/MAX14789E

Full-Duplex, ±35kV ESD-Protected,
RS-485 Transceivers for
High-Speed Communication

Switching Characteristics (MAX14786E/MAX14789E)

(V_{CC} = 3.0V to 5.5V, T_A = T_{MIN} to T_{MAX}, unless otherwise noted. Typical values are at V_{CC} = 5V, and T_A = +25°C.) (Notes 2, 5)

PARAMETER	SYMBOL	CONDITIONS	MIN	TYP	MAX	UNITS
DRIVER						
Driver Propagation Delay	t _{DPLH}	R _L = 54Ω, C _L = 50pF, Figures 2, 3			25	ns
	t _{DPHL}				25	
Differential Driver Output Skew t _{DPLH} - t _{DPHL}	t _{DSKEW}	R _L = 54Ω, C _L = 50pF, Figures 2, 3 (Note 6)			3	ns
Driver Differential Output Rise or Fall Time	t _{HL} , t _{LH}	R _L = 54Ω, C _L = 50pF, Figures 2, 3			10	ns
Maximum Data Rate	DR _{MAX}	R _L = 110Ω, C _L = 50pF, Figures 4, 5	25			Mbps
Driver Enable to Output High	t _{DZH}	R _L = 110Ω, C _L = 50pF, Figures 4, 5			40	ns
Driver Enable to Output Low	t _{DZL}	R _L = 110Ω, C _L = 50pF, Figures 4, 5			40	ns
Driver Disable Time from Low	t _{DLZ}	R _L = 110Ω, C _L = 50pF, Figures 4, 5			40	ns
Driver Disable Time from High	t _{DHZ}	R _L = 110Ω, C _L = 50pF, Figures 4, 5			40	ns
Driver Enable from Shutdown to Output High	t _{DZH(SHDN)}	R _L = 110Ω, C _L = 15pF, Figures 4, 5			100	μs
Driver Enable from Shutdown to Output Low	t _{DZL(SHDN)}	R _L = 110Ω, C _L = 15pF, Figures 4, 5			100	μs
Time to Shutdown	t _{SHDN}	(Note 7)	50		800	ns
RECEIVER						
Receiver Propagation Delay	t _{RPLH}	C _L = 15pF, Figures 6, 7			25	ns
	t _{RPHL}				25	
Receiver Output Skew t _{RPLH} - t _{RPHL}	t _{RSKEW}	C _L = 15pF, Figures 6, 7 (Note 6)			3	ns
Maximum Data Rate	DR _{MAX}		25			Mbps
Receiver Enable to Output High	t _{RZH}	R _L = 1kΩ, C _L = 15pF, Figure 8			30	ns
Receiver Enable to Output Low	t _{RZL}	R _L = 1kΩ, C _L = 15pF, Figure 8			30	ns
Receiver Disable Time from Low	t _{RLZ}	R _L = 1kΩ, C _L = 15pF, Figure 8			30	ns
Receiver Disable Time from High	t _{RHZ}	R _L = 1kΩ, C _L = 15pF, Figure 8			30	ns
Receiver Enable from Shutdown to Output High	t _{RZH(SHDN)}	R _L = 1kΩ, C _L = 15pF, Figure 8			100	μs

Switching Characteristics (MAX14786E/MAX14789E) (continued)

($V_{CC} = 3.0V$ to $5.5V$, $T_A = T_{MIN}$ to T_{MAX} , unless otherwise noted. Typical values are at $V_{CC} = 5V$, and $T_A = +25^\circ C$.) (Notes 2, 5)

PARAMETER	SYMBOL	CONDITIONS	MIN	TYP	MAX	UNITS
Receiver Enable from Shutdown to Output Low	$t_{RZL(SHDN)}$	$R_L = 1k\Omega$, $C_L = 15pF$, Figure 8			100	μs
Time to Shutdown	t_{SHDN}	(Note 7)	50		800	ns

- Note 2:** All devices 100% production tested at $T_A = +25^\circ C$. Specifications over temperature are guaranteed by design.
- Note 3:** All currents into the device are positive; all currents out of the device are negative. All voltages are referenced to ground, unless otherwise noted.
- Note 4:** ΔV_{OD} and ΔV_{OC} are the changes in V_{OD} and V_{OC} , respectively, when the DI input changes state.
- Note 5:** Capacitive load includes test fixture.
- Note 6:** Not production tested. Guaranteed by design.
- Note 7:** Shutdown is enabled by bringing RE high and DE low. If the enabled inputs are in this state for less than 50ns, the device is guaranteed to not enter shutdown. If the enable inputs are in this state for at least 800ns, the device is guaranteed to have entered shutdown.



Figure 1. Driver DC Test Load



Figure 2. Driver Timing Test Circuit

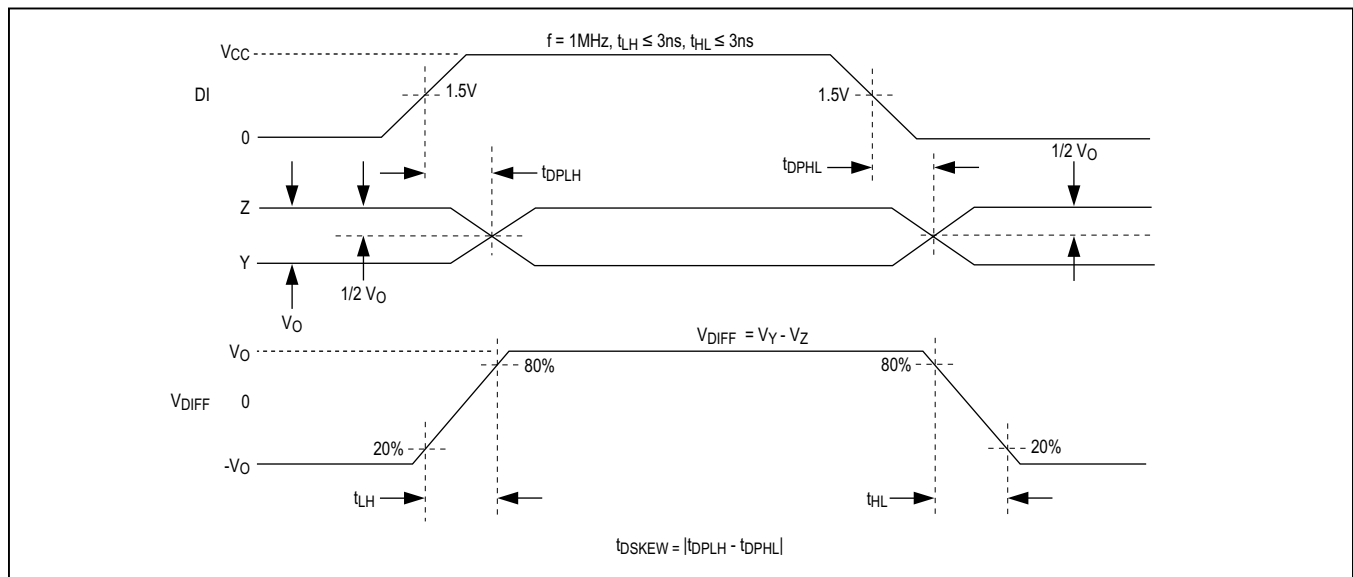

Figure 3. Driver Propagation Delays



Figure 4. Driver Enable and Disable Times (t_{DZH} , t_{DHZ} , $t_{DZH(SHDN)}$)



Figure 5. Driver Enable and Disable Times (t_{DZL} , t_{DLZ} , $t_{DZL(SHDN)}$)



Figure 6. Receiver Propagation Delay Test Circuit

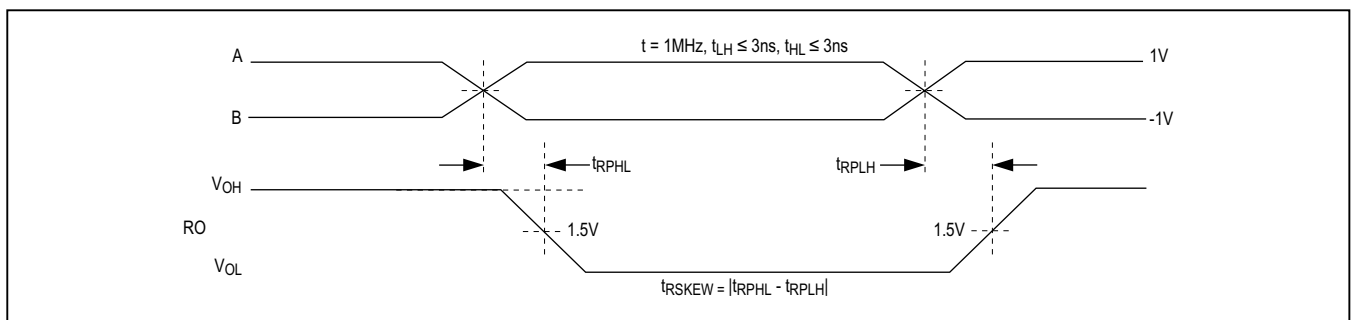

Figure 7. Receiver Propagation Delays



Figure 8. Receiver Enable and Disable Times

MAX14784E/MAX14786E/ MAX14787E/MAX14789E

Full-Duplex, ±35kV ESD-Protected, RS-485 Transceivers for High-Speed Communication

Typical Operating Characteristics

($V_{CC} = 5V$, $T_A = +25^\circ C$, unless otherwise noted.)

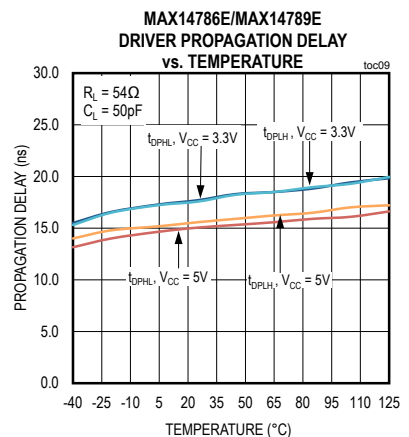
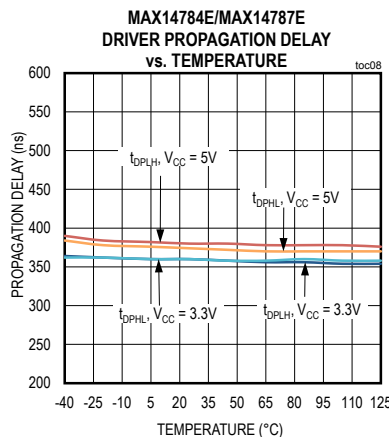
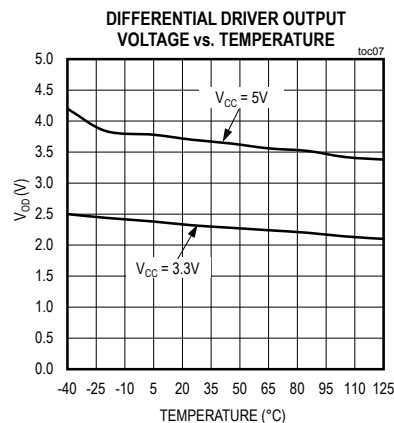

MAX14784E/MAX14786E/
MAX14787E/MAX14789E

Full-Duplex, ±35kV ESD-Protected,
RS-485 Transceivers for
High-Speed Communication

Typical Operating Characteristics (continued)

($V_{CC} = 5V$, $T_A = +25^\circ C$, unless otherwise noted.)

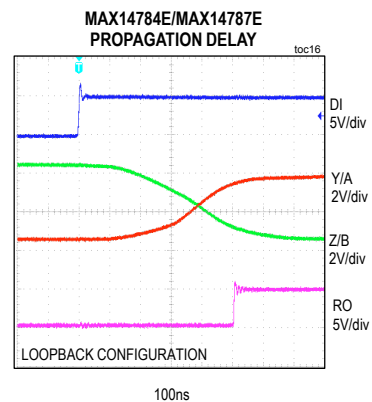
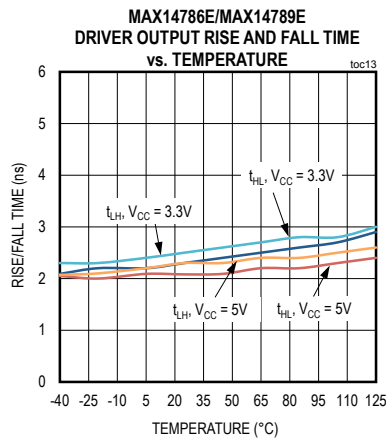

Typical Operating Characteristics (continued)

($V_{CC} = 5\text{V}$, $T_A = +25^\circ\text{C}$, unless otherwise noted.)

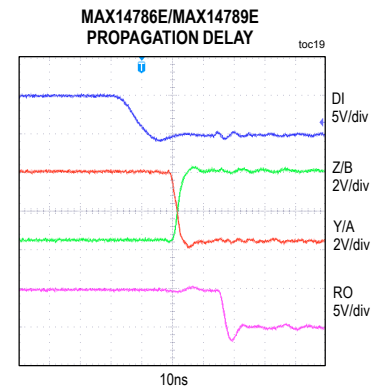
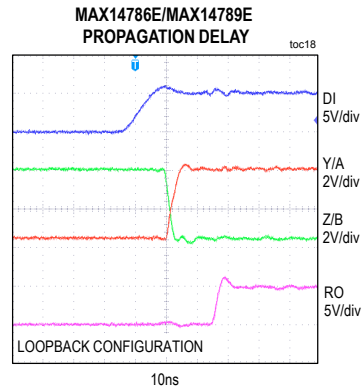
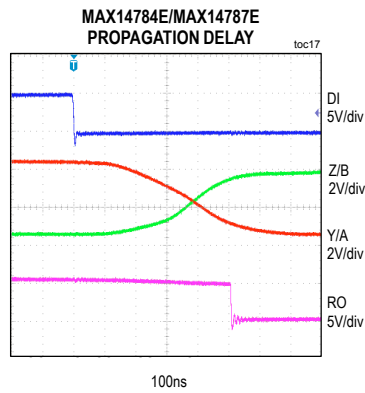

MAX14784E/MAX14786E/
MAX14787E/MAX14789E

Full-Duplex, ±35kV ESD-Protected,
RS-485 Transceivers for
High-Speed Communication

Pin Configurations



Pin Description

PIN		NAME	FUNCTION
MAX14784E MAX14786E	MAX14787E MAX14789E		
1, 8, 13	—	N.C.	No Connection. Not internally connected.
2	2	RO	Receiver Output. Drive RE low to enable RO. RO is always active on the MAX14787E and the MAX14789E. See the <i>Function Tables</i> section.
3	—	RE	Receiver Enable. Drive RE low, or leave unconnected, to enable RO. RO is high impedance when RE is high. Drive RE high and DE low to enter low-power shutdown mode. RE has a weak pulldown to GND.
4	—	DE	Driver Enable. Drive DE high, or leave unconnected, to enable the driver outputs. The driver outputs are high impedance when DE is low. Drive RE high and DE low to enter low-power shutdown mode (MAX14784E and MAX14786E only).
5	3	DI	Driver Input. Drive DE high on the MAX14784E and MAX14786E to enable the driver outputs. Driver outputs are always active on the MAX14787E and the MAX14789E. A low on DI forces the noninverting output, Y, low and the inverting output, Z, high. Similarly, a high on DI forces the noninverting output, Y, high and the inverting output, Z, low. DE has a weak pullup to VCC.
6, 7	4	GND	Ground
9	5	Y	Noninverting Driver Output
10	6	Z	Inverting Driver Output
11	7	B	Inverting Receiver Input
12	8	A	Noninverting Receiver Input
14	1	VCC	Positive Supply. Bypass VCC to GND with a 0.1µF capacitor as close as possible to the IC.

Function Tables

TRANSMITTING				
INPUTS			OUTPUTS	
\overline{RE}^*	DE^*	DI	Y	Z
X	1	1	1	0
X	1	0	0	1
0	0	X	High-Impedance	
1	0	X	Shutdown	

RECEIVING				
INPUTS			OUTPUT	
\overline{RE}^*	DE^*	$V_A - V_B$	RO	
0	X	$\geq -10\text{mV}$	1	
0	X	$\leq -200\text{mV}$	0	
0	X	Open/shorted	1	
1	1	X	High-Impedance	
1	0	X	Shutdown	

* \overline{RE} and DE on the MAX14787E and MAX14789E are internal. The driver outputs and receiver are always active in these devices.

Detailed Description

The MAX14784E/MAX14786E/MAX14787E/MAX14789E are ±35kV ESD protected RS-485 transceivers intended for high-speed, full-duplex communication. These devices operate from a +3.0V to +5.5V supply and feature true fail-safe circuitry, guaranteeing a logic high on the receiver output when inputs are open or shorted.

The MAX14784E and MAX14787E feature a slew-rate limited driver that minimizes EMI and reduces reflections caused by improperly-terminated cables, allowing error-free data transmission at data rates up to 500kbps. The MAX14784E/MAX14787E feature an added deglitch filter on the receiver signal path for enhanced noise immunity when differential signals have very slow rise and fall times. Driver outputs are short-circuit current-limited, with thermal shutdown circuitry that protects drivers against excessive power dissipation.

The MAX14784E/MAX14786E/MAX14787E/MAX14789E transceivers draw 4mA (max) of supply current when unloaded, or when fully-loaded with the drivers disabled. The MAX14784E and MAX14786E draw less than 10µA (max) of supply current in low-power shutdown mode.

True Fail-Safe

The MAX14784E/MAX14786E/MAX14787E/MAX14789E guarantee a logic-high receiver output when either the receiver inputs are shorted or open, or when they are connected to a terminated transmission line with all drivers disabled. If the differential receiver input voltage ($V_A - V_B$) is greater than or equal to -10mV, RO is logic-high.

Receiver Input Deglitch Filter (MAX14784E/MAX14787E Only)

The MAX14784E/MAX14787E include integrated circuitry to filter received data. This input deglitch filter reduces false triggers that can occur when data is passed over long cables. To minimize impact on the bus, the integrated filter is not connected to the receiver inputs. Instead, data is filtered after the differential receiver input but before reaching RO.

Driver Single-Ended Operation

The Y and Z outputs can either be used in the standard differential operating mode, or can be used as single-ended outputs. Since the Y and Z driver outputs swing rail-to-rail, they can individually be used as standard TTL logic outputs.

MAX14784E/MAX14786E/ MAX14787E/MAX14789E

Full-Duplex, $\pm 35\text{kV}$ ESD-Protected, RS-485 Transceivers for High-Speed Communication

Half-Duplex Operation

The MAX14784E/MAX14786E are full-duplex transceivers with driver and receiver enable/disable functionality. To use these devices in a half-duplex configuration, connect the Y output to the A input and connect the Z output to the B input.

Driver Output Protection

Two mechanisms prevent excessive output current and power dissipation caused by faults or by bus contention. The first, a current limit on the output stage, provides immediate protection against short-circuits over the whole common-mode voltage range. The second, a thermal shutdown circuit, force the driver outputs into a high-impedance state if the die temperature exceeds $+160^\circ\text{C}$ (typ).

Low-Power Shutdown Mode (MAX14784E/ MAX14786E Only)

Low-power shutdown mode is initiated by bringing both $\overline{\text{RE}}$ high and DE low. In shutdown, the devices draw only $10\mu\text{A}$ (max) of supply current. $\overline{\text{RE}}$ and DE can be driven simultaneously; the devices are guaranteed not to enter shutdown if $\overline{\text{RE}}$ is high and DE is low for less than 50ns. If the inputs are in this state for at least 800ns, the devices are guaranteed to enter shutdown.

$\pm 35\text{kV}$ ESD Protection

ESD protection structures are incorporated on all pins to protect against electrostatic discharge encountered during handling and assembly. The driver outputs and receiver inputs of the MAX14784E/MAX14786E/MAX14787E/MAX14789E have extra protection against static electricity. The ESD structures withstand high ESD in all states: normal operation, shutdown, and powered down. After an ESD event, the devices keep working without latchup or damage.

ESD protection can be tested in various ways. The transmitter outputs and receiver inputs of the MAX14784E/MAX14786E/MAX14787E/MAX14789E are characterized for protection to the following limits:

- $\pm 35\text{kV}$ HBM
- $\pm 18\text{kV}$ using the Air-Gap Discharge method specified in IEC 61000-4-2
- $\pm 8\text{kV}$ using the Contact Discharge method specified in the IEC 61000-4-2

ESD Test Conditions

ESD performance depends on a variety of conditions. Contact Maxim for a reliability report that documents test setup, test methodology, and test results.

Human Body Model (HBM)

Figure 9 shows the HBM test model, while Figure 10 shows the current waveform it generates when discharged in a low-impedance state. This model consists of a 100pF capacitor charged to the ESD voltage of interest, which is then discharged into the test device through a $1.5\text{k}\Omega$ resistor.

IEC 61000-4-2

The IEC 61000-4-2 standard covers ESD testing and performance of finished equipment. However, it does not specifically refer to integrated circuits. The MAX14784E/MAX14786E/MAX14787E/MAX14789E help facilitate designing equipment to meet the IEC 61000-4-2 specification without the need for additional ESD protection components.

The major difference between tests performed using the HBM and IEC 61000-4-2 is higher peak current in IEC 61000-4-2 due to lower series resistance in the IEC 61000-4-2 model. Hence, the ESD withstand voltage measured to IEC 61000-4-2 is generally lower than that measured using the HBM.

Figure 11 shows the IEC 61000-4-2 model, while Figure 12 shows the current waveform for IEC 61000-4-2 ESD Contact Discharge Test.

MAX14784E/MAX14786E/
MAX14787E/MAX14789E

Full-Duplex, $\pm 35\text{kV}$ ESD-Protected,
RS-485 Transceivers for
High-Speed Communication

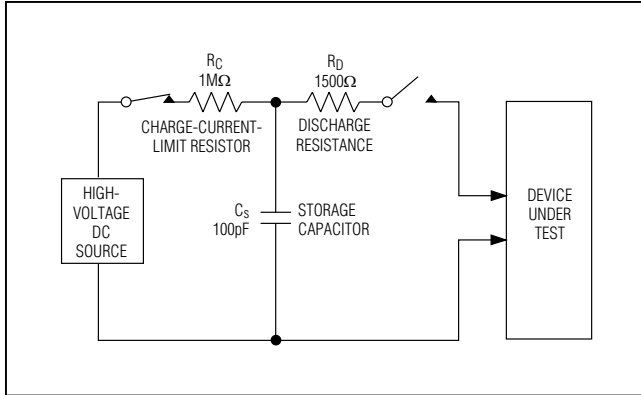

Figure 9. Human Body ESD Test Model



Figure 10. Human Body Current Waveform

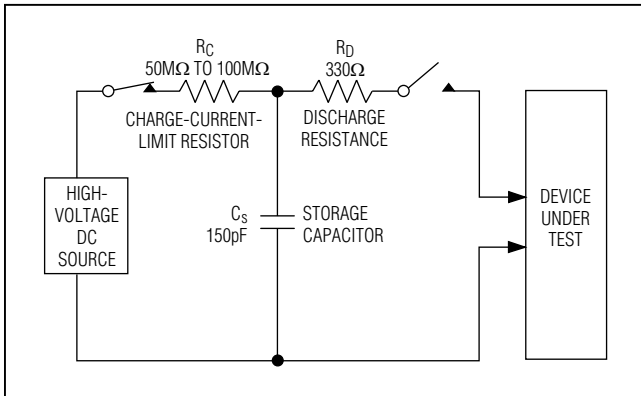

Figure 11. IEC 61000-4-2 ESD Test Model



Figure 12. IEC 61000-4-2 ESD Generator Current Waveform

Typical Application Circuit



MAX14784E/MAX14786E/
MAX14787E/MAX14789E

Full-Duplex, ±35kV ESD-Protected,
RS-485 Transceivers for
High-Speed Communication

Typical Application Circuit (continued)



Ordering Information/Selector Guide

PART	DATA RATE (MAX)	DRIVER SLEW-RATE LIMITED	DEGLITCHED RECEIVER SIGNAL	DRIVER/RECEIVER ENABLE	TEMP RANGE	PIN-PACKAGE
MAX14784EASD+	500kbps	Yes	Yes	Yes	-40°C to +125°C	14 SO
MAX14786EASD+	25Mbps	No	No	Yes	-40°C to +125°C	14 SO
MAX14786EAUD+	25Mbps	No	No	Yes	-40°C to +125°C	14 TSSOP
MAX14787EGSA+	500kbps	Yes	Yes	No	-40°C to +105°C	8 SO
MAX14789EGSA+	25Mbps	No	No	No	-40°C to +105°C	8 SO

+Denotes a lead(Pb)-free/RoHS-compliant package.

Chip Information

PROCESS: BiCMOS

Package Information

For the latest package outline information and land patterns (footprints), go to www.maximintegrated.com/packages. Note that a "+", "#", or "." in the package code indicates RoHS status only. Package drawings may show a different suffix character, but the drawing pertains to the package regardless of RoHS status.

PACKAGE TYPE	PACKAGE CODE	OUTLINE NO.	LAND PATTERN NO.
8 SO	S8+4	21-0041	90-0096
14 SO	S14+1	21-0041	90-0112
14 TSSOP	U14+1	21-0066	90-0113

MAX14784E/MAX14786E/
MAX14787E/MAX14789E

Full-Duplex, ±35kV ESD-Protected,
RS-485 Transceivers for
High-Speed Communication

Revision History

REVISION NUMBER	REVISION DATE	DESCRIPTION	PAGES CHANGED
0	12/13	Initial release	—
1	6/14	Removed future product asterisk from MAX14789E	1
2	1/15	Updated <i>General Description</i> and <i>Benefits and Features</i> sections	1

For pricing, delivery, and ordering information, please contact Maxim Direct at 1-888-629-4642, or visit Maxim Integrated's website at www.maximintegrated.com.

Maxim Integrated cannot assume responsibility for use of any circuitry other than circuitry entirely embodied in a Maxim Integrated product. No circuit patent licenses are implied. Maxim Integrated reserves the right to change the circuitry and specifications without notice at any time. The parametric values (min and max limits) shown in the Electrical Characteristics table are guaranteed. Other parametric values quoted in this data sheet are provided for guidance.



Компания «ЭлектроПласт» предлагает заключение долгосрочных отношений при поставках импортных электронных компонентов на взаимовыгодных условиях!

Наши преимущества:

- Оперативные поставки широкого спектра электронных компонентов отечественного и импортного производства напрямую от производителей и с крупнейших мировых складов;
- Поставка более 17-ти миллионов наименований электронных компонентов;
- Поставка сложных, дефицитных, либо снятых с производства позиций;
- Оперативные сроки поставки под заказ (от 5 рабочих дней);
- Экспресс доставка в любую точку России;
- Техническая поддержка проекта, помощь в подборе аналогов, поставка прототипов;
- Система менеджмента качества сертифицирована по Международному стандарту ISO 9001;
- Лицензия ФСБ на осуществление работ с использованием сведений, составляющих государственную тайну;
- Поставка специализированных компонентов (Xilinx, Altera, Analog Devices, Intersil, Interpoint, Microsemi, Aeroflex, Peregrine, Syfer, Eurofarad, Texas Instrument, Miteq, Cobham, E2V, MA-COM, Hittite, Mini-Circuits, General Dynamics и др.);

Помимо этого, одним из направлений компании «ЭлектроПласт» является направление «Источники питания». Мы предлагаем Вам помощь Конструкторского отдела:

- Подбор оптимального решения, техническое обоснование при выборе компонента;
- Подбор аналогов;
- Консультации по применению компонента;
- Поставка образцов и прототипов;
- Техническая поддержка проекта;
- Защита от снятия компонента с производства.



Как с нами связаться

Телефон: 8 (812) 309 58 32 (многоканальный)

Факс: 8 (812) 320-02-42

Электронная почта: org@eplast1.ru

Адрес: 198099, г. Санкт-Петербург, ул. Калинина, дом 2, корпус 4, литера А.