



Features

- 3" x 5" x 1.38" Package
- Up to 275W of AC-DC Power
- For 1U Applications
- Universal Input 90-264 Vac Input Range
- Standby and Fan Output Voltages
- Forced Current Share
- Inhibit, Power Fail, Output OK Signals
- Approved to CSA/EN/IEC/UL60950-1, 2nd Edition
- Efficiency 92% typical
- 3 Year Warranty
- RoHS Compliant



Description

A Superior performance 275 Watts AC to DC power supply designed for industrial and ITE applications. Feature rich and highly efficient CINT1275 product family with active current share for redundant applications can easily fit in 1U chassis and provides 180 Watts for convection or 275 Watts with moving air. Input & output monitoring alarms plus isolated 12V/1A fan output and 5V standby voltage are among other standard offering of CINT1275 family. All 5 models are CE marked to low voltage directive and approved to ITE standards of EN60950, 2nd edition.

Model Selection

| Model Number | Volts | Output Current | | Fan Output | Ripple & Noise** | Total Regulation | OVP Threshold*** |
|------------------|-------|----------------|-------------|------------|------------------|------------------|------------------|
| | | w/200LFM air | Convection* | | | | |
| CINT1275A1214K01 | 12V | 21.8A | 15.0A | 12Vdc/1A | 120mV pk-pk | ±3% | 14.0 ± 1.1V |
| CINT1275A1514K01 | 15V | 18.3A | 12.0A | 12Vdc/1A | 150mV pk-pk | ±3% | 19.5 ± 1.5V |
| CINT1275A2414K01 | 24V | 10.9A | 7.50A | 12Vdc/1A | 240mV pk-pk | ±3% | 28.0 ± 2.5V |
| CINT1275A4814K01 | 48V | 5.46A | 3.75A | 12Vdc/1A | 480mV pk-pk | ±3% | 55.0 ± 4.0V |
| CINT1275A5614K01 | 56V | 4.68A | 3.21A | 12Vdc/1A | 560mV pk-pk | ±3% | 59.0 ± 1.0V |

Notes: * Total convection power is 180 Watts.

** Measured with noise probe directly across output terminals, and load terminated with 0.1µF ceramic and 10µF low ESR capacitors.

*** No output adjustment on 56V.

General Specifications

| | | | |
|-----------------------|--|-----------------------------------|--|
| AC Input | 100-240Vac, ±10%, 47-63Hz, 1Ø 120-370Vdc | Turn On Time | Less than 2 sec. @115Vac (inversely proportional to input voltage and thermistor temperature) |
| Input Current | 115Vac: 3A, 230Vac: 1.5A 3.7A max. at 90Vac | Hold-up Time | 16mS at 250W, 120Vac/60Hz |
| Inrush Current | 264Vac, cold start: will not exceed 50A | Overtemperature Protection | Sensing transformer temperature, 135°C (55°C ambient temperature at full load), latching type. |

General Specifications (continued)

| | | | |
|------------------------------|--|---------------------------------|--|
| Input Fuses | F1, F2: 5A, 275Vac fuses provided on all models | Overload Protection | 120 to 150% of rating, Hiccup Mode |
| Earth Leakage Current | <750 μ A@264Vac, 60Hz, NC | Short Circuit Protection | Hiccup Mode, auto recovery. |
| Efficiency | 92% typical | Overvoltage Protection | OVP latch at 110 to 130% of output voltage |
| Output Power | 275W continuous, with 200 lfm airflow, 180W convection cooled – See chart for specific voltage model ratings. | Switching Frequency | PFC: Variable, 30kHz - 400kHz Main Converter: Variable 30-250kHz, 65-70kHz at full load. |
| Transient Response | 500 μ S typical, return to 0.5% of nominal, 50% load step. $\Delta i/\Delta t$: <0.2A/ μ S. Max Voltage Deviation = 3% | Isolation | Input-Output: 4000Vac Input-Ground: 1800Vac Output-Ground: 1500Vac |
| Ripple and Noise | 0.5%rms, 1% pk-pk, see chart. | Operating Temperature | -10°C to +70°C Start Up at -40°C, full load |
| Output Voltage | See chart | Temperature Derating | Derate output power linearly above 50°C to 50% at 70°C |
| Voltage Adjustability | +/-5% from nominal (except 56V) | Storage Temperature | -40°C to +85°C |
| Minimum Load | Not required | Altitude | Operating: -500 to 10,000 ft. Non-operating: -500 to 40,000 ft. |
| Total Regulation | +/- 3% combined line, load and initial setting. | Relative Humidity | 5% to 95%, non-condensing |
| Vibration | Operating: 0.003g/Hz, 1.5grms overall, 3 axes, 10 min/axis Non-Operating: 0.026g ² /Hz, 5.0grms overall, 3 axes, 1 hr/axis | Shock | Operating: Half-sine, 20gpk, 10ms, 3 axes, 6 shocks total Non-Operating: Half-sine, 40 gpk, 10 ms, 3 axes, 6 shocks total |
| Dimensions | W: 3.0" x L: 5.0" x H: 1.38" (from bottom of PC Board). | Safety Standards | EN/CSA/UL/IEC 60950-1, 2nd Edition |
| Weight | 325g | MTBF | 465,000 hours, 275W load, 110Vac input, 25°C ambient |

Auxiliary Signals

| | | | |
|-----------------------|--|-----------------------|--|
| AC Power Fail: | Goes LOW with 5mS warning before loss of DC output after loss of AC power. | DC OK: | Open collector logic signal goes and stays HIGH 100mS to 500mS after main output reaches regulation. |
| Inhibit: | Connect to inhibit pin (J201 pin 5) to output common to inhibit the DC output. | Fan Output: | 12V @ 1A |
| Remote Sense: | Compensates for up to 250mV drop in load lines. | Current Share: | Forced Current Sharing provided for up to 5 units connected in parallel. |

EMI/EMC Compliance

| | |
|--|---|
| Conducted Emissions | EN55011/22 Class B, FCC Part 15, Subpart B, Class B |
| Radiated Emissions | EN55011/22 Class A, FCC Part 15, Subpart B, Class A w/6db margin |
| Static Discharge Immunity | EN61000-4-2, 6kV Contact Discharge, 8kV air discharge |
| Radiated RF Immunity | EN61000-4-3, 3V/m. |
| EFT/Burst Immunity | EN61000-4-4, 2kV/5kHz |
| Line Surge Immunity | EN61000-4-5, 1kV differential, 2kV common-mode |
| Conducted RF Immunity | EN61000-4-6, 3Vrms |
| Power Frequency Magnetic Field Immunity | EN61000-4-8, 3A/m |
| Voltage Dip Immunity | EN61000-4-11, 100%, 10ms; 30%, 275ms; 60%, 100ms; Performance Criteria A, A, & A at 70% load. |
| Line Harmonic Emissions | EN61000-3-2, Class A, B, C, & D |
| Flicker Test | EN61000-3-3, Complies (dmax<6%) |

Mechanical Drawing

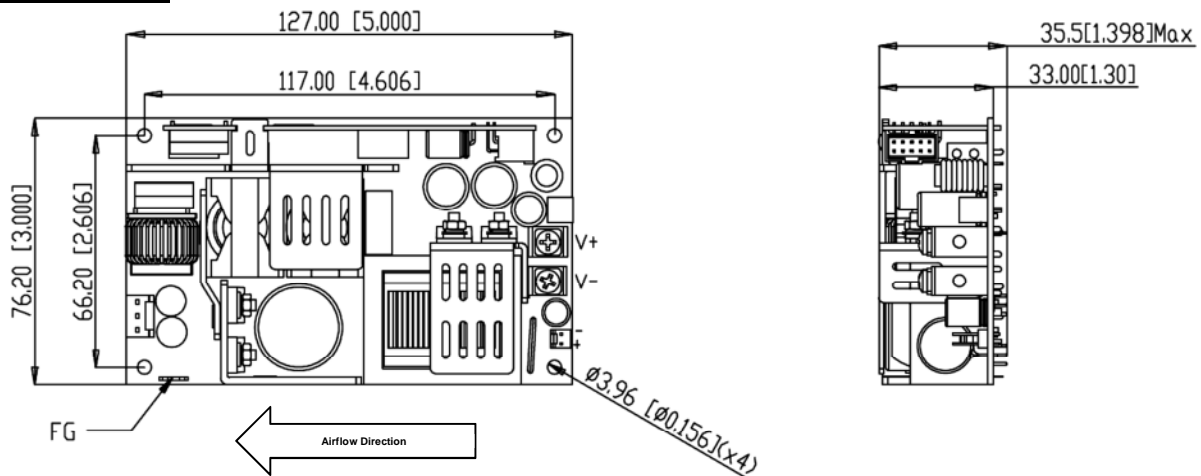

- Notes:**
1. All dimensions in inches (mm), tolerance is +/-0.02".
 2. Mounting holes should be grounded for EMI purposes.
 3. FG is safety ground connection.
 4. The power supply requires mounting on metal standoffs 0.20" (5mm) in height, min.

Connector Information

| Input Connector | Ground | DC Output Connector | Fan Output Connector | Signal Connector |
|---|--|---|---|--|
| PIN 1) AC LINE PIN 2) EMPTY PIN 3) AC NEUTRAL | 0.25" FASTON TAB | Term. 1: +Vout Term. 2: -Vout | PIN 1) +12V fan RTN PIN 2) +12V fan | PIN 1) Remote Sense (+) PIN 2) Common PIN 3) Remote Sense (-) PIN 4) Current Share PIN 5) Inhibit Pin 6) Common Pin 7) Power Good Pin 8) +5Vsb Pin 9) DC OK Pin 10) +5Vsb RTN |
| Mating Connector: Molex 09-50-3031 Pins: 08-52-0072 | Mating Connector: Molex 01- 90020001 | Mating Connector: Molex 19141- 0058/0063/0083 | Mating Connector: Molex 22-01-3027 Pins: 08-50-0114 | Mating Connector: Molex 90119-0010 or Pins: 90119-2110 AMP 87977-3 Pins: 87309-8 |

Fan Output – J301

J301 provides a 12V@1A output to support a system cooling fan. The fan output is always available when AC input is present, so it also can be used for a 12V standby output is so desired.

AC Power Failure/DC OK Current Share and Inhibit Signals – J201

1. Power fail/DC OK

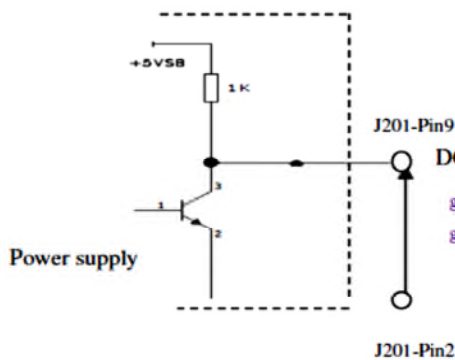

Note: Because Power Fail and DC OK use the same pin, the signals can be monitored as follows:

DC OK: When J201-Pin 9 is HIGH

AC Power Fail: When J201-Pin 9 is LOW

DC OK: During normal operation stays HIGH

goes HIGH 100-500 ms after main output

goes LOW with 5ms warning before loss of output from AC failure

Figure 1

2. Inhibit

Remote inhibit control of the DC output.

J201 pin 5 open = ON
J201 pin 5 LOW or GND = OFF

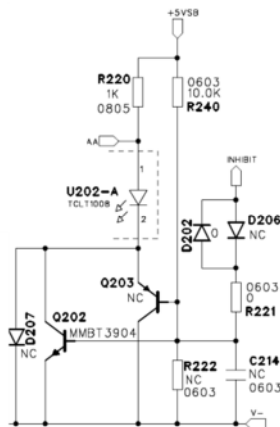

Figure 2: Inhibit Circuit

3. Current Sharing/Remote Sense

The outputs of N+1 (N=1,2...5) models can be shared. It is shown in Figure 3, one load-share controller is required for each model and circuits are identical when N+ 1 identical models are used.

Terminals J302 and J303 are connected to the Vo+ and Vo-, respectively, of the first power model. The Vo+ and Vo- correspond to the other models positive and negative output pins. The Vo+ connects to positive output bus to the load and Vo- connects the negative output bus to the load.

The J201 pin1 and pin3 connects to the S+ and S-, respectively, of the first power models. The S+ and S- correspond to the other models J201 pin1 and pin3. The S+ connects to positive output bus and S- connects to negative output bus.

Remote Sense < 250mV drop compensation:

The J201 Pin4 connects to current sharing bus that it connects to other models J201 pin4.

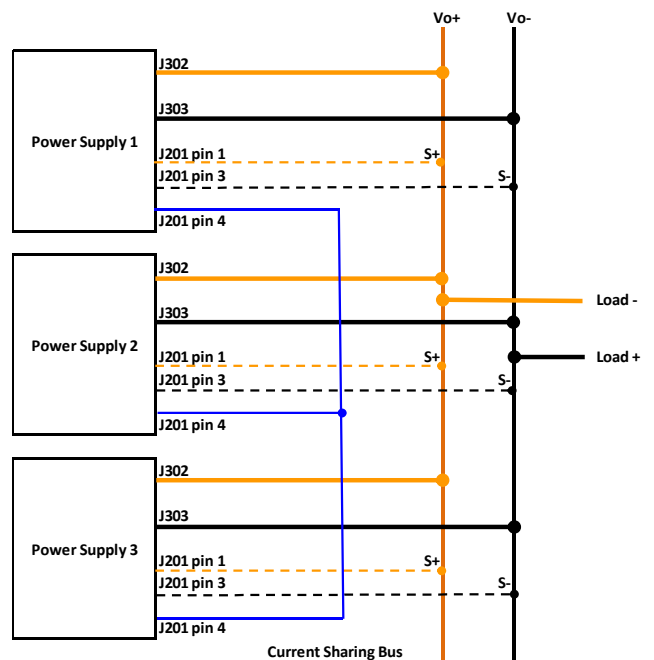
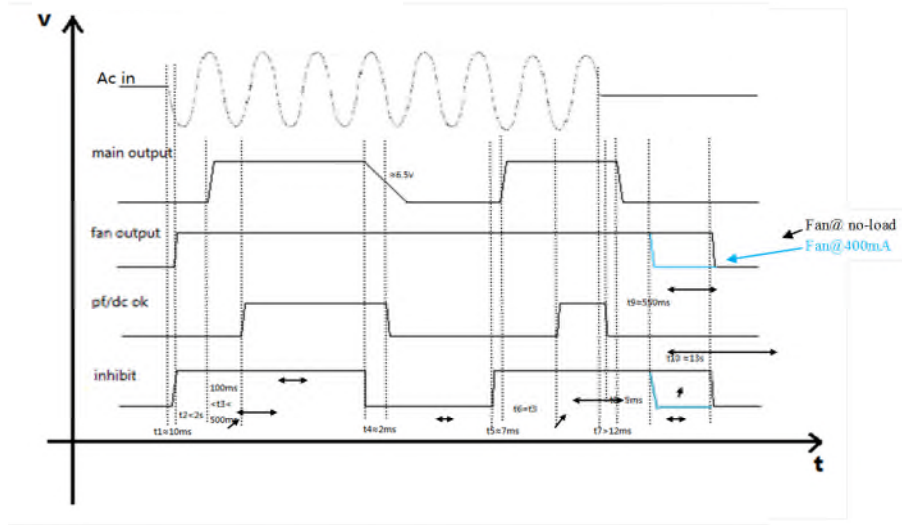

Figure 3: Current Share Method

Timing Sequence



Isolation Specifications

| Parameter | Conditions/Description | Min | Nom | Max | Units |
|--------------------------------|---|----------------------|----------------------------|-----|-------------------|
| Insulation Safety Rating | Input/Ground Input/Output Output/Ground | | Basic Reinforced n/a | | |
| Electric Strength Test Voltage | Input/Ground Input/Output Output/Ground | 1800 4000 1500 | - | - | Vac Vac Vac |

Input Specifications

All specifications apply over specified input voltage, output load, and temperature range, unless otherwise noted.

| Parameter | Conditions/Description | Min | Nom | Max | Units |
|---------------------------|--|-----|---------|-----|-------|
| Input Voltage | | 90 | 115/230 | 264 | Vac |
| Turn-On Input Voltage | Ramping up | | 80 | | Vac |
| Turn-Off Input Voltage | Ramping down | | 75 | | Vac |
| Input Frequency | | 47 | 50/60 | 63 | Hz |
| Inrush Current Limitation | 264Vac, cold start | - | - | 50 | A |
| Power Factor | $V_{i\ nom}, I_{o\ nom}$ | 0.9 | - | - | |
| Efficiency | $V_{i\ nom}, I_{o\ nom}$ CINT1275A1214K01 CINT1275A1514K01 CINT1275A2414K01 CINT1275A4814K01 CINT1275A5614K01 | - | 92% | - | % |

Output Specifications

| Parameter | Conditions/Description | Min | Nom | Max | Units |
|--|---|--------|-----------|--------------|---------------------|
| Output Voltage Setpoint Accuracy CINT1275A1214K01 | $V_{i \text{ nom}, I_{o1}}$ @ ADC, $T_C = 25^\circ\text{C}$ | -3 | - | 3 | % $V_o \text{ nom}$ |
| Output Voltage Setpoint Accuracy CINT1275A1514K01 | $V_{i \text{ nom}, I_{o1}}$ @ ADC, $T_C = 25^\circ\text{C}$ | -3 | - | 3 | % $V_o \text{ nom}$ |
| Output Voltage Setpoint Accuracy CINT1275A2414K01 | $V_{i \text{ nom}, I_{o1}}$ @ ADC, $T_C = 25^\circ\text{C}$ | -3 | - | 3 | % $V_o \text{ nom}$ |
| Output Voltage Setpoint Accuracy CINT1275A4814K01 | $V_{i \text{ nom}, I_{o1}}$ @ ADC, $T_C = 25^\circ\text{C}$ | -3 | - | 3 | % $V_o \text{ nom}$ |
| Output Voltage Setpoint Accuracy CINT1275A5614K01 | $V_{i \text{ nom}, I_{o1}}$ @ ADC, $T_C = 25^\circ\text{C}$ | -3 | - | 3 | % $V_o \text{ nom}$ |
| Output Current V1 Output Current V2 | CINT1275A1214K01 | 0 0 | 15.0 - | 21.83 1.0 | ADC ADC |
| Output Current V1 Output Current V2 | CINT1275A1514K01 | 0 0 | 12.0 - | 17.47 1.0 | ADC ADC |
| Output Current V1 Output Current V2 | CINT1275A2414K01 | 0 0 | 7.5 - | 10.92 1.0 | ADC ADC |
| Output Current V1 Output Current V2 | CINT1275A4814K01 | 0 0 | 3.75 - | 5.46 1.0 | ADC ADC |
| Output Current V1 Output Current V2 | CINT1275A5614K01 | 0 0 | 3.21 - | 4.68 1.0 | ADC ADC |
| Static Line Regulation V1 | $V_i \text{ min-} V_i \text{ max}, V_{i \text{ nom}}, 0\text{-}100\% I_o \text{ nom}$ | -1 | - | 1 | % $V_o \text{ nom}$ |
| Static Load Regulation V1 (Droop Characteristic) | $V_i \text{ min-} V_i \text{ max}, V_{i \text{ nom}}, 0\text{-}100\% I_o \text{ nom}$ | -3 | - | 3 | % $V_o \text{ nom}$ |
| Hold-Up Time | Starting at $V_i = 230 \text{ VAC}, P_o \text{ nom}$ | - | 16 | - | ms |
| Dynamic Load Regulation | Load change =50%, $di/dt = 0.2\text{A}/\mu\text{S}$ voltage deviation 3% | 0 | | 3 | % $V_o \text{ nom}$ |
| Start-Up Time | $V_{i \text{ nom}}, I_o \text{ nom}$ | 0 | - | 2 | s |

Protection

All specifications apply over specified input voltage, output load, and temperature range, unless otherwise noted

| Parameter | Conditions/Description | Min | Nom | Max | Units |
|-----------------------------|---|-----|-----|-----|---------|
| Input Fuse | Not user accessible | | | | |
| Input Transient Protection | 2KV(CM) and 1KV(DM) surge | | | 2 | KV (CM) |
| Output | No-load and short circuit proof | | | | Hiccup |
| | short circuit proof | | | | Hiccup |
| | overload (latch style) | | | | Hiccup |
| Overvoltage Protection | Latch style | | | | Latch |
| Over temperature Protection | Automatic power shutdown at $T_C = 135^\circ\text{C}$ | | | | |

Characteristic Curves

Output vs. Temperature

180W convection cooled and 275W continuous with 200 LFM airflow, derate output power to 50% at 70°C.

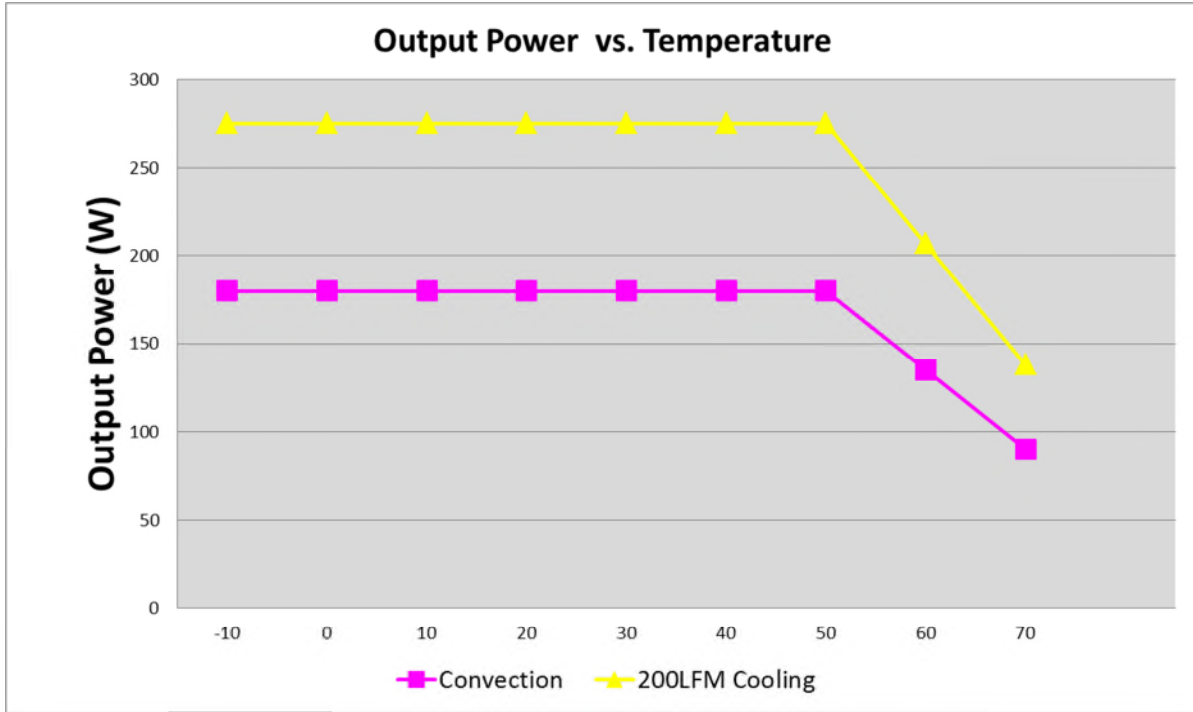

Efficiency vs. Loading

The high efficiency is achieved by using LLC technology with CCM mode PFC topology, and synchronous rectifiers on the output in all of this family models, minimizing switching losses.

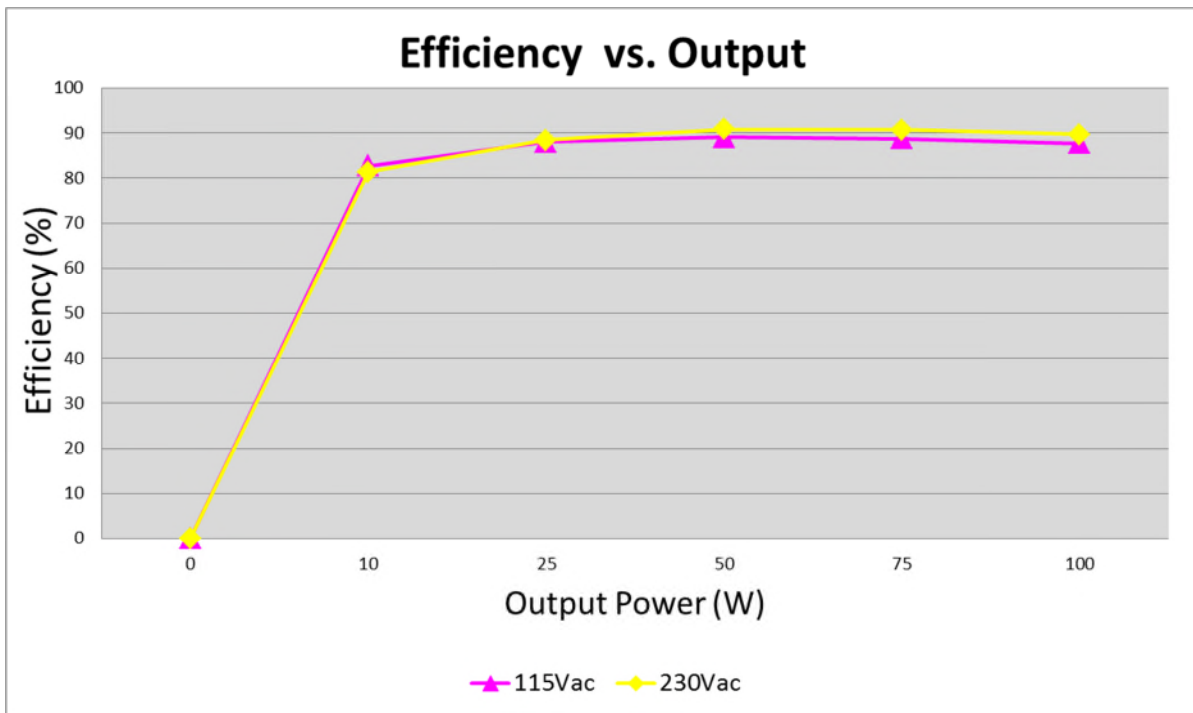

Noise & Ripple

To verify that the output ripple and noise does not exceed the level specified in the product specification. Measured using a scope probe socket with 0.1uF ceramic and a 10uF electrolysis capacitor connected in parallel across it, BW limit with 20MHz.

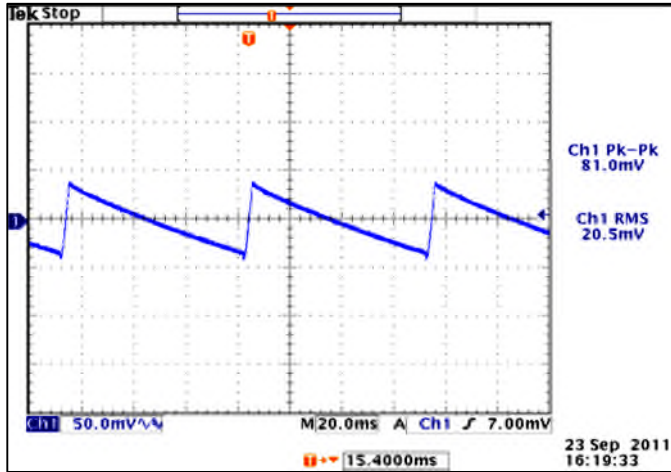

[12V OUT, NO LOAD, 115VAC, 60Hz](#)

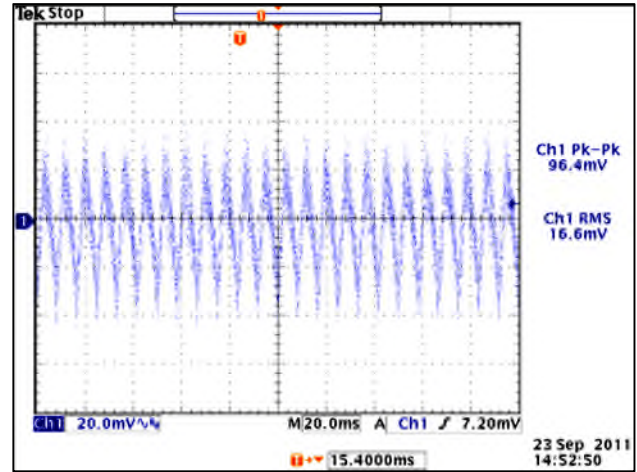

[12V OUT, FULL LOAD, 115VAC, 60Hz](#)

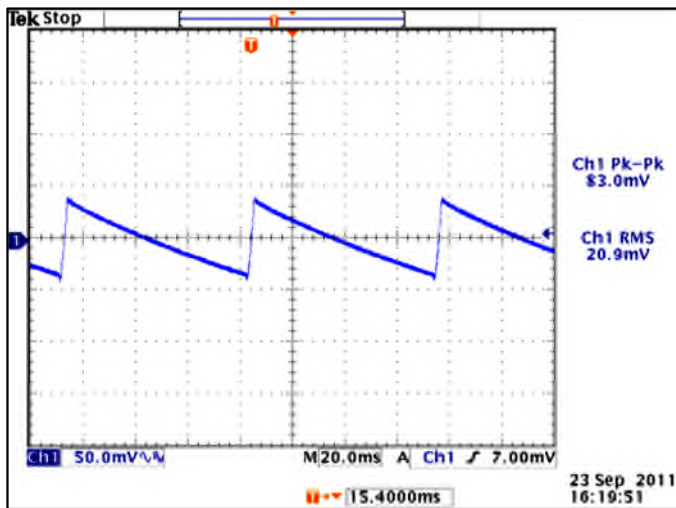

[12V OUT, NO LOAD, 230VAC, 60Hz](#)

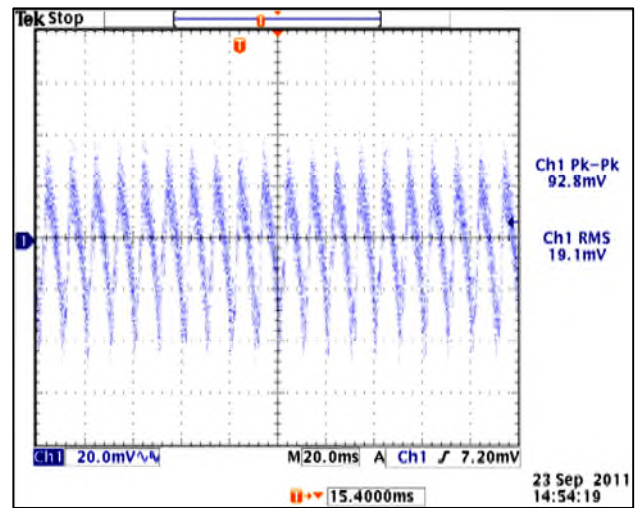

[12V OUT, FULL LOAD, 230VAC, 60Hz](#)

Output Transient Response

50% load step within the regulation limits of minimum and maximum load, $di/dt < 0.2A/\mu\text{Sec}$. Recovery time not specified as there is no laps in regulation with a 50% Load Step. Maximum voltage deviation is 3%. This test is performed on the MAIN OUTPUT ONLY.

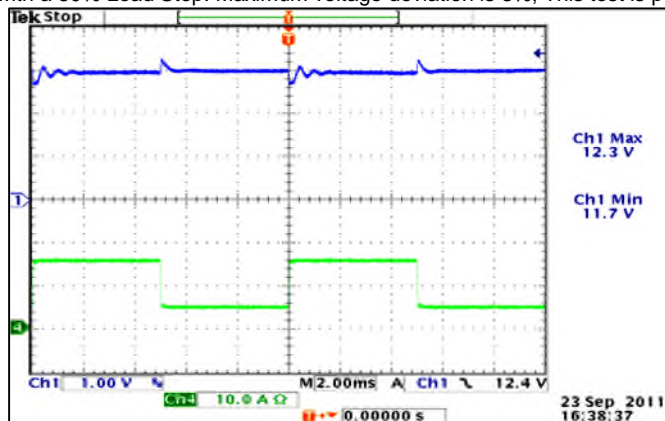

[12V OUT, 115VAC, 25% TO 75% LOAD STEP](#)

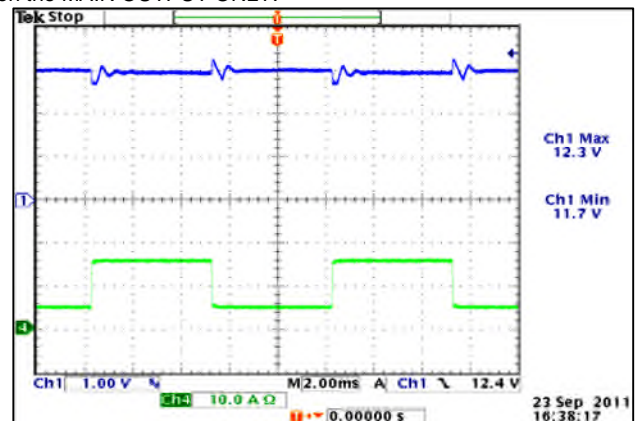

[12V OUT, 230VAC, 25% TO 75% LOAD STEP](#)

Output Overload Characteristic

Supply shall protect itself against Overload conditions. The Power Supply shall recover from Overload Conditions without operator intervention.

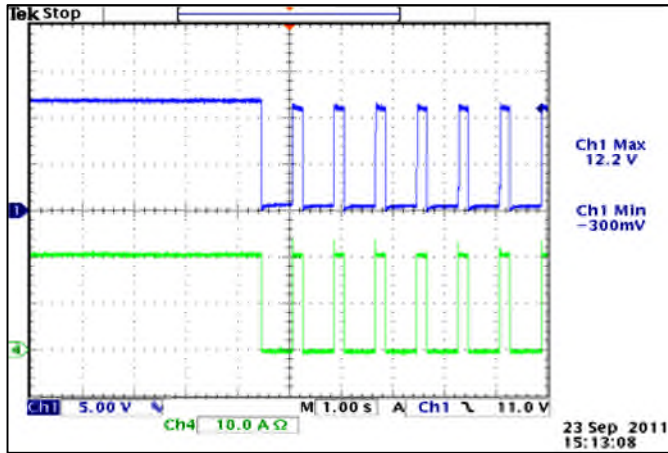

12V OUT, 90VAC

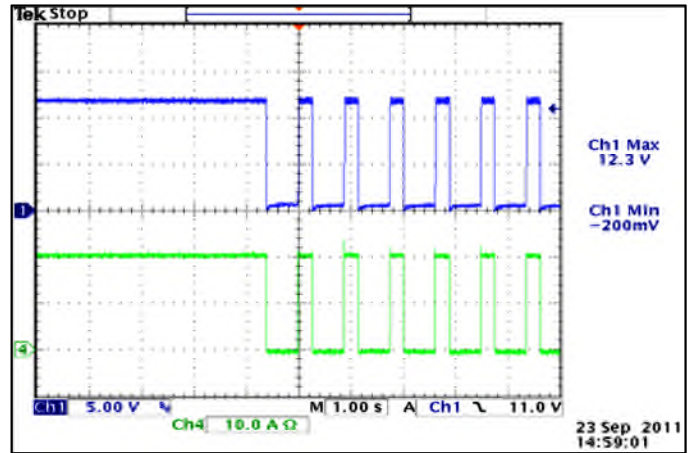

12V OUT, 264VAC

Turn-On Time

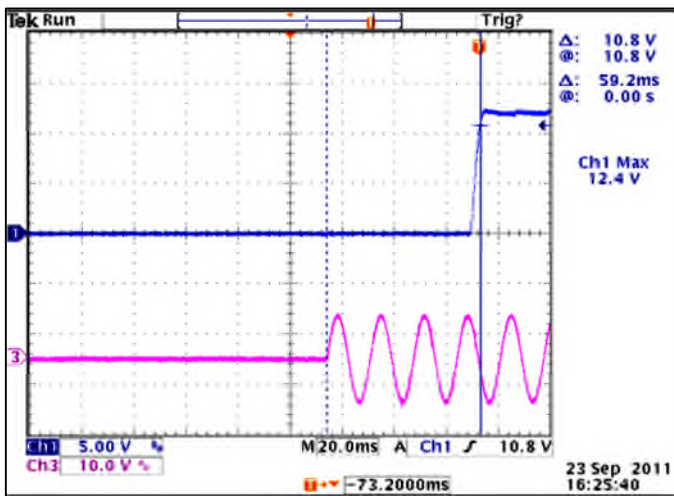

12V OUT, NO LOAD, 90VAC

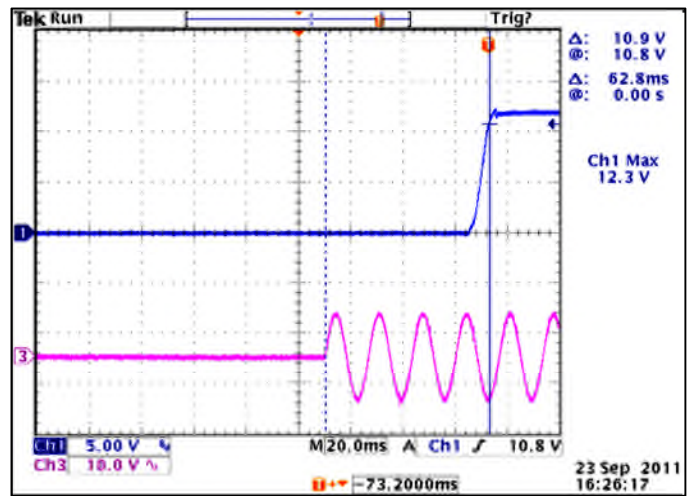

12V OUT, FULL LOAD, 90VAC

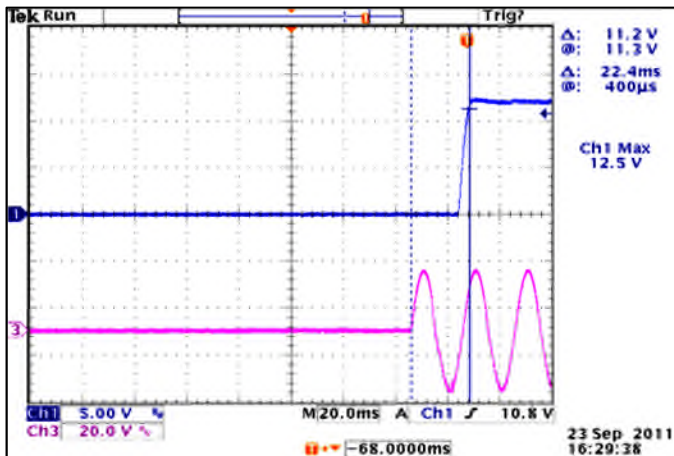

12V OUT, NO LOAD, 264VAC

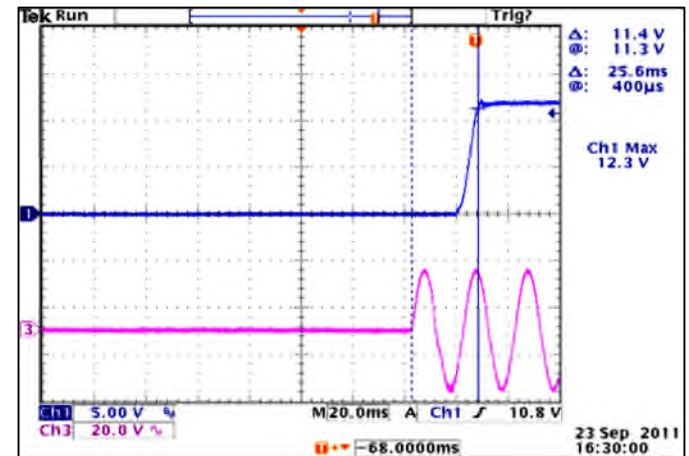

12V OUT, FULL LOAD, 264VAC



Компания «ЭлектроПласт» предлагает заключение долгосрочных отношений при поставках импортных электронных компонентов на взаимовыгодных условиях!

Наши преимущества:

- Оперативные поставки широкого спектра электронных компонентов отечественного и импортного производства напрямую от производителей и с крупнейших мировых складов;
- Поставка более 17-ти миллионов наименований электронных компонентов;
- Поставка сложных, дефицитных, либо снятых с производства позиций;
- Оперативные сроки поставки под заказ (от 5 рабочих дней);
- Экспресс доставка в любую точку России;
- Техническая поддержка проекта, помощь в подборе аналогов, поставка прототипов;
- Система менеджмента качества сертифицирована по Международному стандарту ISO 9001;
- Лицензия ФСБ на осуществление работ с использованием сведений, составляющих государственную тайну;
- Поставка специализированных компонентов (Xilinx, Altera, Analog Devices, Intersil, Interpoint, Microsemi, Aeroflex, Peregrine, Syfer, Eurofarad, Texas Instrument, Miteq, Cobham, E2V, MA-COM, Hittite, Mini-Circuits, General Dynamics и др.);

Помимо этого, одним из направлений компании «ЭлектроПласт» является направление «Источники питания». Мы предлагаем Вам помощь Конструкторского отдела:

- Подбор оптимального решения, техническое обоснование при выборе компонента;
- Подбор аналогов;
- Консультации по применению компонента;
- Поставка образцов и прототипов;
- Техническая поддержка проекта;
- Защита от снятия компонента с производства.



Как с нами связаться

Телефон: 8 (812) 309 58 32 (многоканальный)

Факс: 8 (812) 320-02-42

Электронная почта: org@eplast1.ru

Адрес: 198099, г. Санкт-Петербург, ул. Калинина, дом 2, корпус 4, литера А.