

PT-39-L51-TE

Deep Red and Green LED Chipset

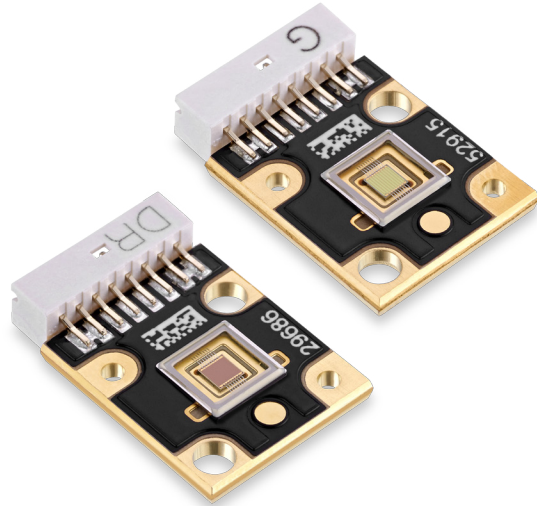

Table of Contents

Technology Overview	2
Binning Structure	3
Optical & Electrical Characteristics	4
Optical & Electrical Characteristics Graphs	5
Optical Spectrum	8
Thermal Resistance	9
Mechanical Dimensions	10

Features:

- Matched Chipset with 2.09 mm × 1.87 mm (3.9 mm²) emitting area
- Ultra-low thermal resistance, 1.2°C/W junction-to-heat sink
- Targeted peak wavelengths: Deep-red 650 nm, Green 520 nm
- LED mounted on copper core-PCB for easier thermal and optical integration
- RoHS (EU-2002/95/EC Directive) and REACH compliant

Applications

- Life Sciences
- Medical
- Microdisplay
- Fiber Coupling
- Horticulture

Technology Overview

Luminus LEDs benefit from innovations in device technology, chip packaging and thermal management. This suite of technologies give engineers and system designers the freedom to develop solutions both high in power and efficiency.

Luminus Technology

Luminus' technology enables large area LED chips to emit photons uniformly over the entire LED chip surface. The intense optical power density produced by these devices facilitate designs which replace arc and halogen lamps where arrays of traditional high power LEDs cannot.

Luminus engineers their parts to maximize light extraction and to emit with a Lambertian far-field distribution pattern. The design maximizes efficiency and allows for flexible optical designs.

Packaging Technology

Thermal management is critical in high power LED applications. Luminus PT-39 LEDs have the lowest thermal resistance of any LED on the market with a thermal resistance from junction to heat sink of 1.2°C/W. This allows the LED to be driven at higher current densities while maintaining a low junction temperature, thereby resulting in brighter solutions and longer lifetimes.

Reliability

Luminus LEDs are designed from the ground up to deliver one of the most reliable light sources in the world today. Luminus LEDs have passed a rigorous suite of environmental and mechanical stress tests, including mechanical shock, vibration, temperature cycling and humidity, and have been fully qualified for use in extreme high power and high current applications. With very low failure rates and median lifetimes that typically exceed 10,000 hours, Luminus LEDs are ready for even the most demanding applications.

Environmental Benefits

Luminus LEDs help reduce power consumption and the amount of hazardous waste entering the environment. All Luminus LED products manufactured by Luminus are RoHS compliant and free of hazardous materials, including lead and mercury.

Understanding Luminus LED Test Specifications

Every Luminus LED is fully tested to ensure that it meets the high quality standards expected from Luminus' products.

Testing Temperature

Luminus core board products are typically measured in such a way that the characteristics reported agree with how the devices will actually perform when incorporated into a system. This measurement is accomplished by mounting the devices on a 40°C heat sink. This method of measurement ensures that Luminus LEDs perform in the field just as they are specified.

Operating Points

The tables on the following pages provide typical optical and electrical characteristics. The LEDs can be operated over a wide range of drive conditions (currents from <1A to 12 A, and duty cycle from <1% to 100%).

PT-39 devices are production specified at 7.5 A. Any other values shown are for additional reference at other possible drive conditions.

PT-39 Binning Structure

PT-39 LEDs are specified for luminous flux and chromaticity/wavelength at a drive current of 7.5 A (1.92 A/mm²) and placed into one of the following Power Bins and Wavelength Bins:

Power Bins

Color	Power Flux Bin (FF)	Minimum Flux (W)	Maximum Flux (W)
Deep Red	BD	2.6	2.8
	BE	2.8	3.0
	BF	3.0	3.2
Green	CD	2.6	2.8
	CE	2.8	3.0
	CF	3.0	3.2

*Note: Luminus maintains a +/- 6% tolerance on power measurements.

Peak Wavelength Bins

Color	Wavelength Bin (123)	Minimum Wavelength (nm)	Maximum Wavelength (nm)
Deep Red	R10	645	650
	R11	650	655
Green	G2	510	515
	G3	515	520
	G4	520	525
	G5	525	530

Reference Optical & Electrical Characteristics ($T_{hs} = 40^{\circ}\text{C}$)^{1,2}

	Symbol	Deep Red	Green	Unit
Current Density ^{3,4}	j	1.92	1.92	A/mm ²
Forward Voltage	V_{Fmin}	2.1	3.0	V
	$V_{F,typ}$	2.3	5.0	V
	V_{Fmax}	3.0	5.5	V
Radiometric Flux ⁵	Φ_{typ}	2.7	2.7	W
Radiometric Flux Density ⁵	Φ_R	0.74	0.74	W/mm ²
Peak Wavelength Range	λ	645 - 655	510 - 530	nm
Peak Wavelength ⁵	λ_p	650	520	nm
FWHM ⁵	$\Delta\lambda_{1/2}$	20	33	nm
	Symbol	Deep Red	Green	Unit
Emitting Area		3.9	3.9	mm ²
Emitting Area Dimensions		1.87 x 2.09	1.87 x 2.09	mm x mm

Absolute Maximum Ratings

	Symbol	Deep Red	Green	Unit
Minimum Current (CW or Pulsed) ⁶		200	200	mA
Maximum Current CW ⁶		10	10	A
Maximum Current Pulsed ⁶		12	12	A
Maximum Junction Temperature ^{6,7}	T_{jmax}	110	150	°C
Storage Temperature Range		-40 to +100	-40 to +100	°C

Note 1: Data verified using NIST traceable calibration standard.

Note 2: All data are based on test conditions with a constant heat sink temperature $T_{hs} = 40^{\circ}\text{C}$ under pulse testing conditions. Pulse duration 20 msec, single pulse.

Note 3: Unless otherwise noted, values listed are typical. Devices are production tested and specified at 7.5 A.

Note 4: Listed drive conditions are typical for common applications. Drive current and duty cycle should be adjusted as necessary to maintain the junction temperature desired to meet application lifetime requirement.

Note 5: Typical values

Note 6: Product performance and lifetime data is specified at recommended forward drive currents. Sustained operation at or near absolute minimum or maximum currents may result in reduced device performance or lifetime compared to operation at recommended forward currents.

Note 7: Sustained operation at or above Maximum Operating Junction Temperature (T_{jmax}) will result in reduced device life time.

Optical & Electrical Characteristics Graphs

Relative Power vs I_f [A]

Deep Red

Relative Power vs Forward Current (I_f)
Normalized to 6 A and $T_j = 100^\circ\text{C}$

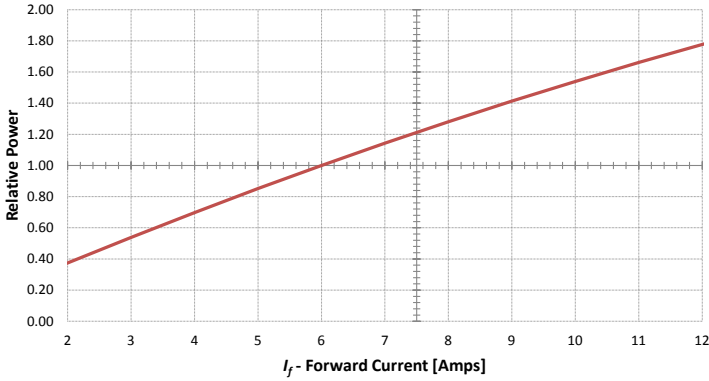

Green

Relative Power vs Forward Current (I_f)
Normalized to 6 A and $T_j = 120^\circ\text{C}$

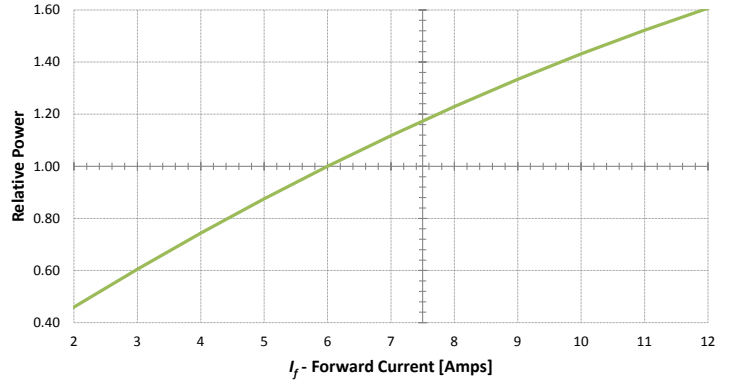

Change in V_f vs I_f [A]

Deep Red

Change in Forward Voltage (V_f) vs Forward Current (I_f)
Referenced to 6 A and $T_j = 100^\circ\text{C}$

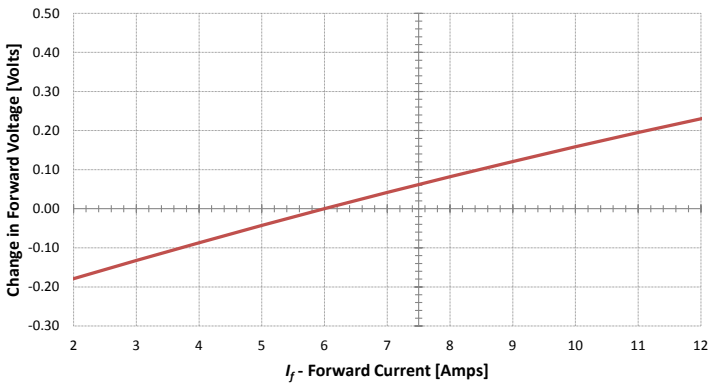

Green

Change in Forward Voltage (V_f) vs Forward Current (I_f)
Referenced to 6 A and $T_j = 120^\circ\text{C}$

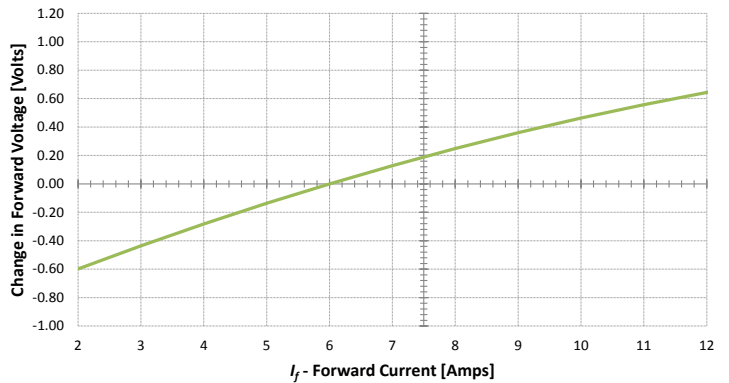

Change in λ_p [nm] vs I_f [A]

Deep Red

Change in Peak Wavelength (λ_p) vs Forward Current (I_f)
Referenced to 6 A and $T_j = 100^\circ\text{C}$

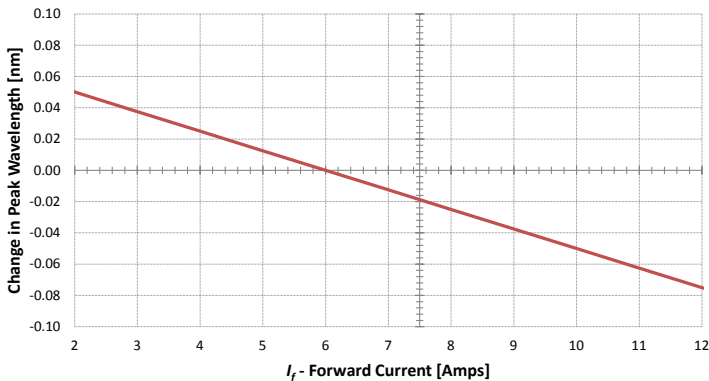

Green

Change in Peak Wavelength (λ_p) vs Forward Current (I_f)
Referenced to 6 A and $T_j = 120^\circ\text{C}$

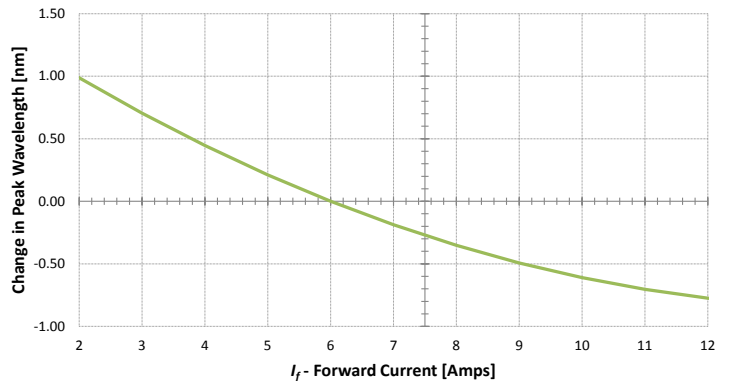

Optical and Electrical Characteristics Graphs

Change in FWHM vs I_f [A]

Deep Red

Change in Full-Width Half-Maximum vs Forward Current (I_f)
Referenced to 6 A and $T_j = 100^\circ\text{C}$

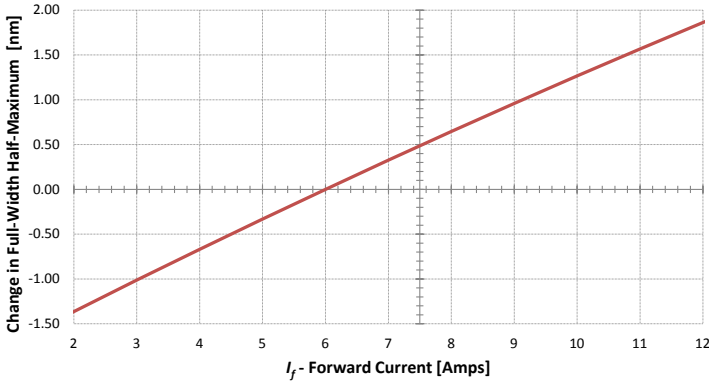

Green

Change in Full-Width Half-Maximum vs Forward Current (I_f)
Referenced to 6 A and $T_j = 120^\circ\text{C}$

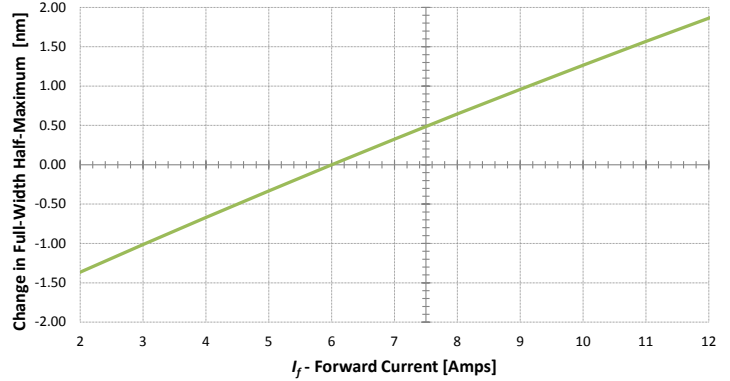

Relative Power vs T_j [$^\circ\text{C}$]

Deep Red

Relative Power vs Junction Temperature (T_j)
Normalized to 80°C

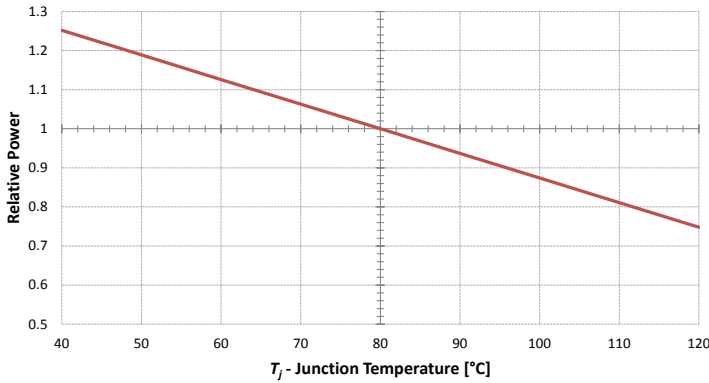

Green

Relative Power vs Junction Temperature (T_j)
Normalized to 80°C

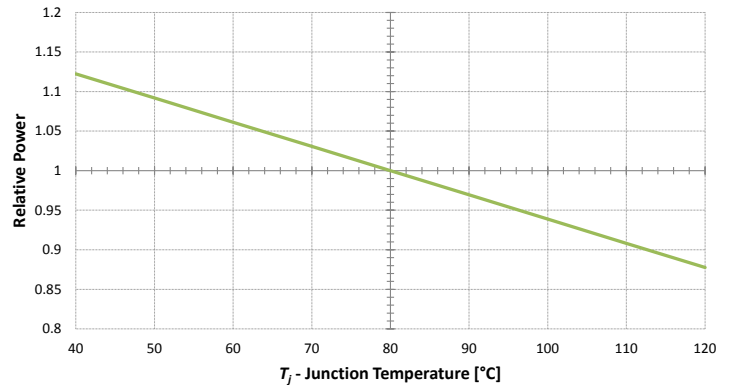

Change in V_f vs T_j [$^\circ\text{C}$]

Deep Red

Change in Forward Voltage (V_f) vs Forward Current (I_f)
Referenced to 6 A and $T_j = 100^\circ\text{C}$

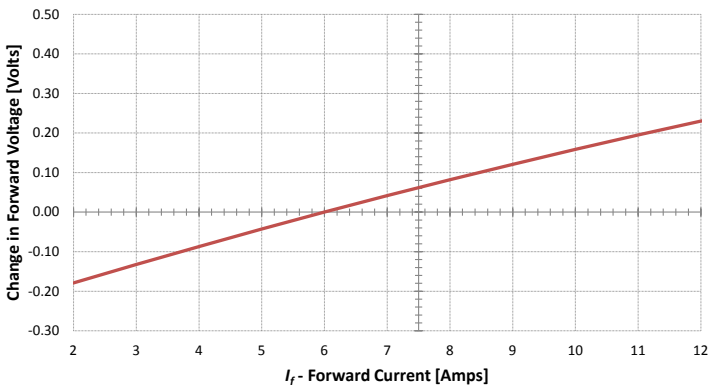

Green

Change in Forward Voltage (V_f) vs Junction Temperature (T_j)
Referenced to 80°C

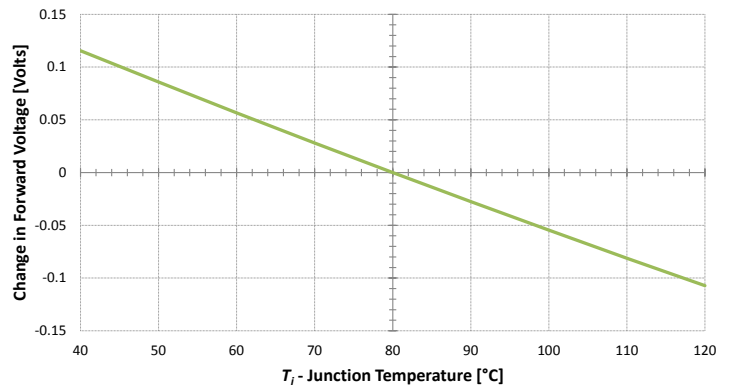

Optical and Electrical Characteristics Graphs
Change in λ_p vs T_j [°C]
Deep Red

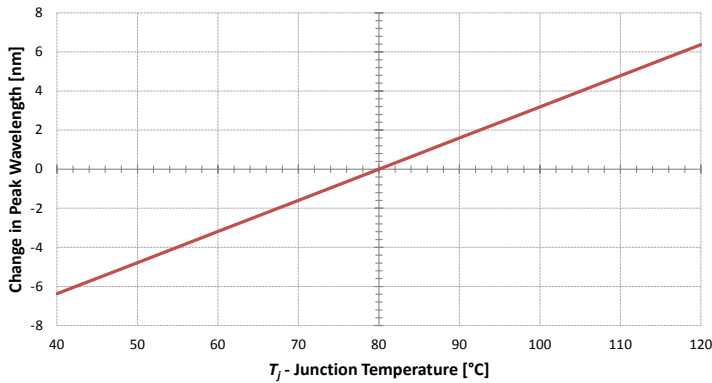
 Change in Peak Wavelength (λ_p) vs Temperature (T_j)
 Referenced to 80°C

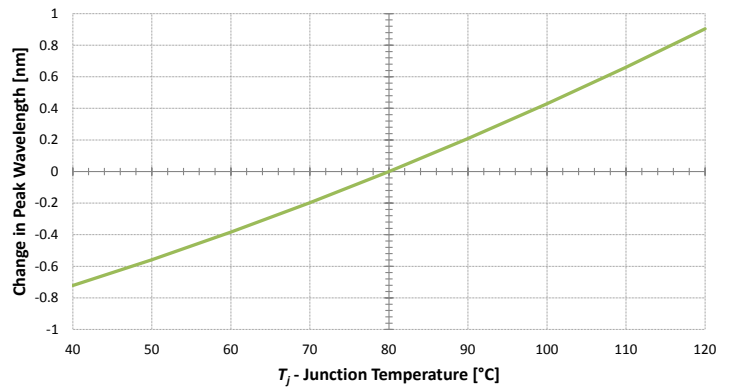
Green

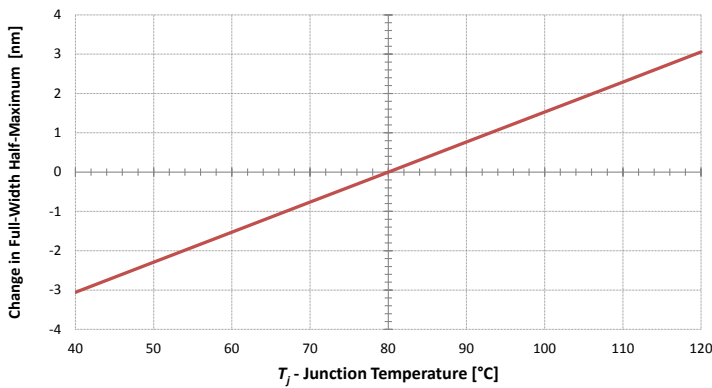
 Change in Peak Wavelength (λ_p) vs Temperature (T_j)
 Referenced to 80°C

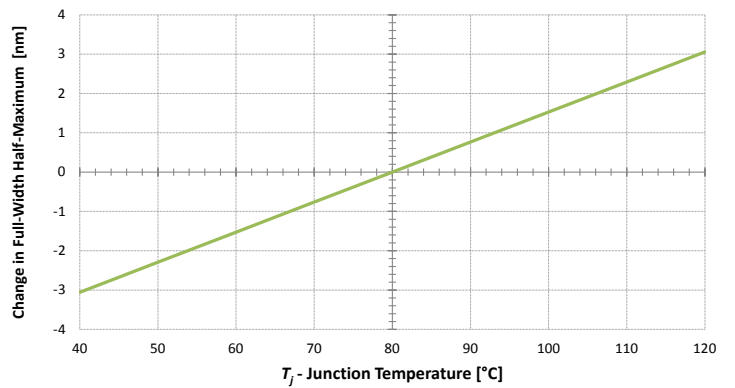
Change in FWHM vs T_j [°C]
Deep Red

 Change in Full-Width Half-Maximum (FWHM) vs Temperature (T_j)
 Referenced to 80°C

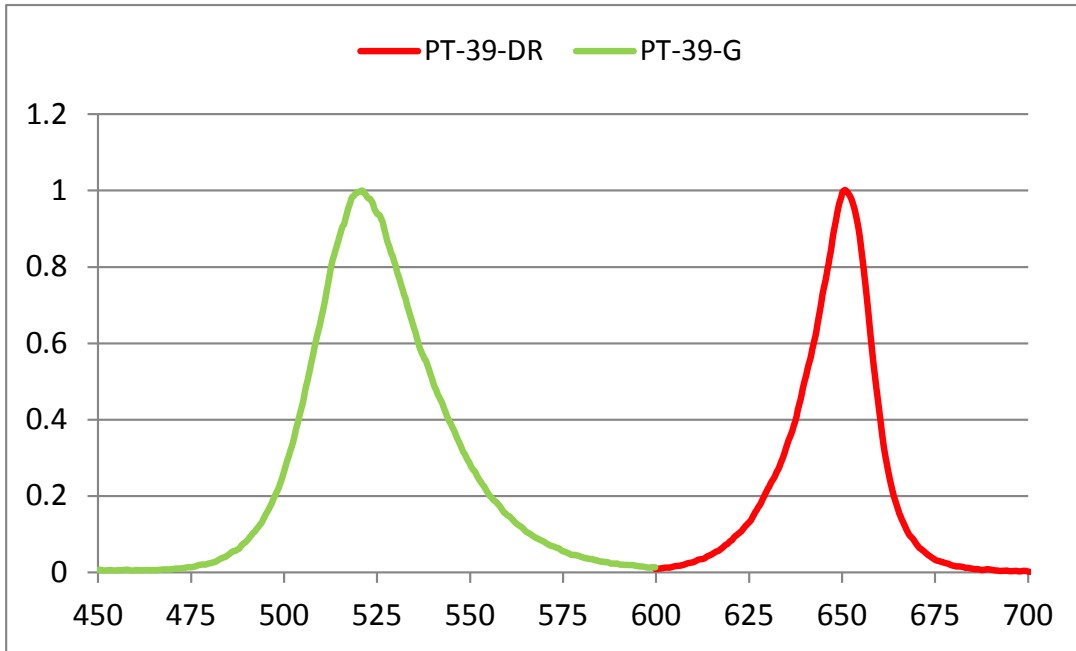
Green

 Change in Full-Width Half-Maximum (FWHM) vs Temperature (T_j)
 Referenced to 80°C

Optical Spectrum (Typical)

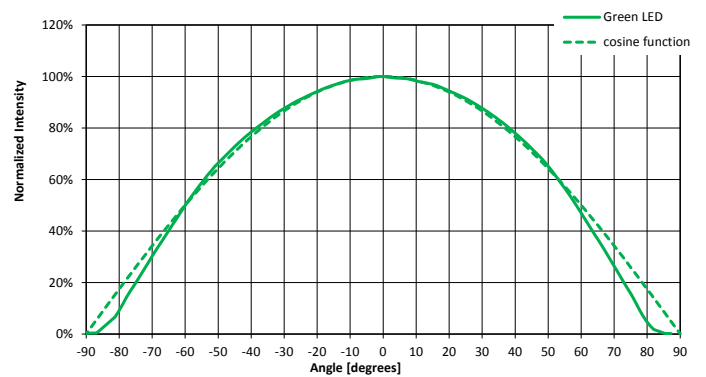
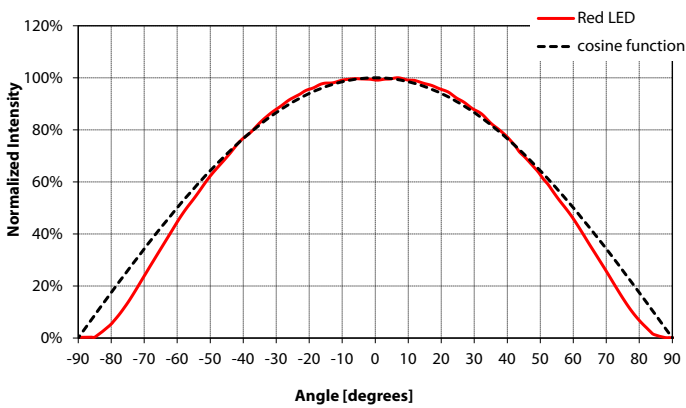

Angular Intensity Distribution (Typical)



Thermal Resistance

Typical Thermal Resistance

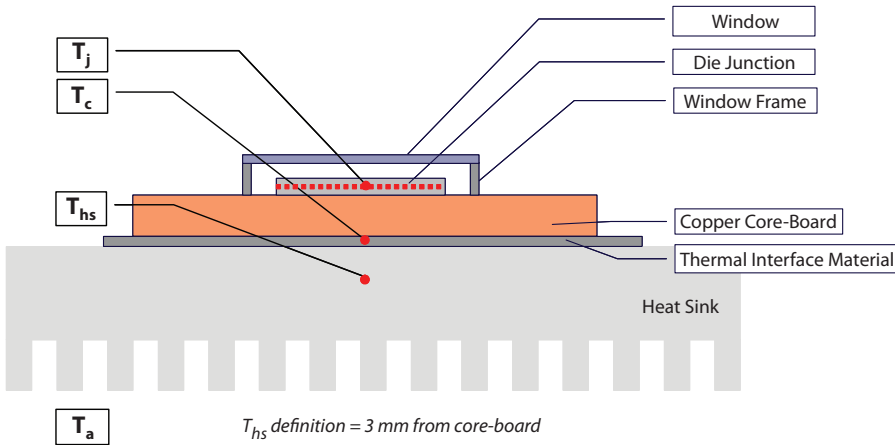

$R_{\theta j-b}^1$	1.0°C/W
$R_{\theta b-hs}^2$	0.2°C/W
$R_{\theta j-hs}^{1,2}$	1.2°C/W

Note 1: Thermal resistance values are based on modeled results correlated to measured $R_{\theta j-hs}$ data using the wavelength shift method.

Note 2: Thermal Resistance is based on eGraf 1205 Thermal interface.

Electrical Pinout

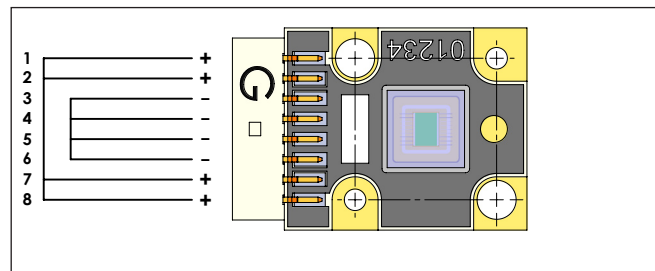

Green and Deep Red Devices

Mechanical Dimensions

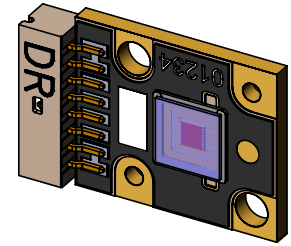
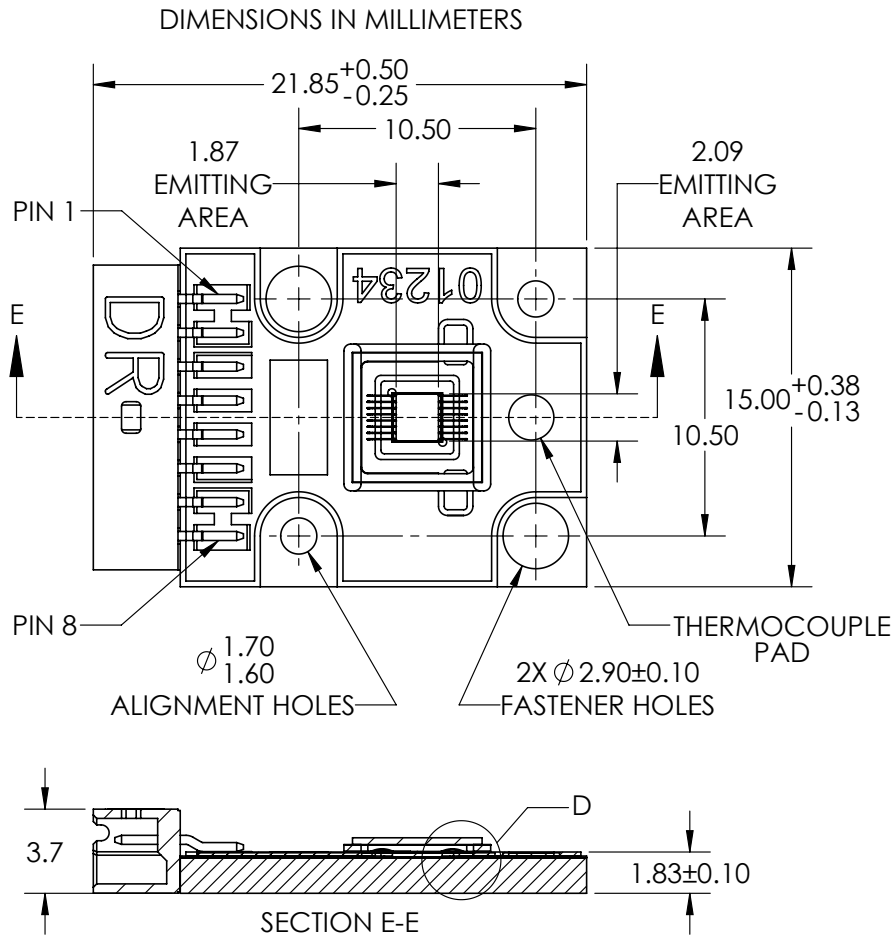

DEEP RED LED DEVICE

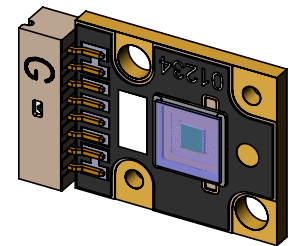

GREEN LED DEVICE

PIN ASSIGNMENTS		
LED COLOR	CATHODE (-)	ANODE (+)
DEEP RED	3,4,5,6	1,2,7,8
GREEN		

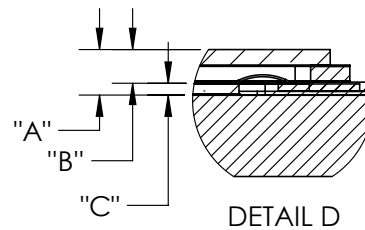

DIMENSION NAME	DESCRIPTION	NOMINAL DIMENSION	TOLERANCE
"A"	TOP OF METAL SUBSTRATE TO TOP OF WINDOW	0.88	±0.13
"B"	TOP OF DIE EMITTING AREA TO TOP OF WINDOW	0.65	±0.11
"C"	TOP OF METAL SUBSTRATE TO TOP OF DIE EMITTING AREA	0.23	±0.02

Notes:

- 1) Deep-Red and Green PT-39-L51, Big Chip LEDs are individually assembled into a common anode copper core-board with a footprint of 21.85mm x 15 mm.
- 2) Dimensions above are for information only. Please refer to the latest revision of the DWG-002140 package outline mechanical specifications.
- 3) Connector Information:
 Manufacturer: Tarng-Yu: Part # TU1512HNO-08-M5
- 4) PT-39-L51 Mating Connector Cable Assembly ordering part number (for evaluation purposes only): 960041

Ordering Part Number	Color	Description
PT-39-DR-L51-BD100	Deep Red	PT-39 -DR consisting of a 3.9 mm ² LED, with a minimum power of 2.6W, a wavelength range from 645nm to 655nm, a connector and a copper-core PCB.
PT-39-G-L51-CD100	Green	PT-39 -G consisting of a 3.9 mm ² LED, with a minimum power of 2.6W, a wavelength range from 510nm to 530nm, a connector and a copper-core PCB.

History of Changes

Rev	Date	Description of Change
01	04/25/2016	Initial Release
02	04/13/2017	Updated max Vf specification from 5.0 to 5.5V and typical from 4.0 to 5.0V. Added min forward current = 200 mA.



Компания «ЭлектроПласт» предлагает заключение долгосрочных отношений при поставках импортных электронных компонентов на взаимовыгодных условиях!

Наши преимущества:

- Оперативные поставки широкого спектра электронных компонентов отечественного и импортного производства напрямую от производителей и с крупнейших мировых складов;
- Поставка более 17-ти миллионов наименований электронных компонентов;
- Поставка сложных, дефицитных, либо снятых с производства позиций;
- Оперативные сроки поставки под заказ (от 5 рабочих дней);
- Экспресс доставка в любую точку России;
- Техническая поддержка проекта, помощь в подборе аналогов, поставка прототипов;
- Система менеджмента качества сертифицирована по Международному стандарту ISO 9001;
- Лицензия ФСБ на осуществление работ с использованием сведений, составляющих государственную тайну;
- Поставка специализированных компонентов (Xilinx, Altera, Analog Devices, Intersil, Interpoint, Microsemi, Aeroflex, Peregrine, Syfer, Eurofarad, Texas Instrument, Miteq, Cobham, E2V, MA-COM, Hittite, Mini-Circuits, General Dynamics и др.);

Помимо этого, одним из направлений компании «ЭлектроПласт» является направление «Источники питания». Мы предлагаем Вам помощь Конструкторского отдела:

- Подбор оптимального решения, техническое обоснование при выборе компонента;
- Подбор аналогов;
- Консультации по применению компонента;
- Поставка образцов и прототипов;
- Техническая поддержка проекта;
- Защита от снятия компонента с производства.



Как с нами связаться

Телефон: 8 (812) 309 58 32 (многоканальный)

Факс: 8 (812) 320-02-42

Электронная почта: org@eplast1.ru

Адрес: 198099, г. Санкт-Петербург, ул. Калинина, дом 2, корпус 4, литера А.