

LOW-POWER DUAL C-MOS OPERATIONAL AMPLIFIER

■ GENERAL DESCRIPTION

The NJU7014/7015/7016 are single supply dual C-MOS operational amplifiers featuring a low operating voltage from 1V and low operating current of 15 μ A/circuit (7014 typ.), 80 μ A/circuit (7015 typ.), 200 μ A/circuit (7016 typ.).

They also have a low input bias current of 1pA (typ.) and input voltage range from ground, which can provide a ground sensing, and rail-to-rail output swing in both rails.

The NJU7014/7015/7016 are available in a wide variety of 8-lead packages, dual-in-line DIP8, surface-mount SOP8 (DMP8), SSOP8, MSOP8 (VSP8), MSOP8 (TVSP8). The combination of these specifications makes them ideal for a variety of portable devices.

■ PACKAGE OUTLINE

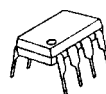

NJU7015D
NJU7016D
(DIP8)



NJU7014M
NJU7015M
NJU7016M
(DMP8)



NJU7014V
NJU7015V
NJU7016V
(SSOP8)



NJU7014R
NJU7015R
NJU7016R
(MSOP8(VSP8))



NJU7014RB1
NJU7015RB1
NJU7016RB1
(MSOP8(TVSP8))

■ FEATURES

- Single Power Supply
- Wide Operating Voltage $V_{DD}=1\sim 5.5V$
- Wide Output Swing Range $V_{OM}=2.9V$ min. (@ $V_{DD}=3.0V$)
- Low Operating Current
- Low Bias Current $I_B=1pA$ typ.
- Compensation Capacitor Incorporated
- C-MOS Technology
- Package Outline

NJU7015D, NJU7016D : DIP8

NJU7014M, NJU7015M, NJM7016M : DMP8

NJU7014V, NJU7015V, NJM7016V : SSOP8

NJU7014R, NJU7015R, NJM7016R : MSOP8(VSP8) MEET JEDEC MO-187-DA

NJU7014RB1, NJU7015RB1, NJM7016RB1 : MSOP8(VSP8) MEET JEDEC MO-187-DA / THIN TYPE

■ PIN CONFIGURATION



■ LINE-UP

($T_a=25^{\circ}C, V_{DD}=3.0V, \text{Per Circuit}$)

PARAMETER	NJU7014	NJU7015	NJU7016	UNIT
Operating Current	15	80	200	μ A (typ)
Slew Rate	0.1	1.0	2.4	V/ μ s (typ)
Unity Gain Bandwidth	0.2	1.0	1.0	MHz (typ)

NJU7014/15/16

■ EQUIVALENT CIRCUIT

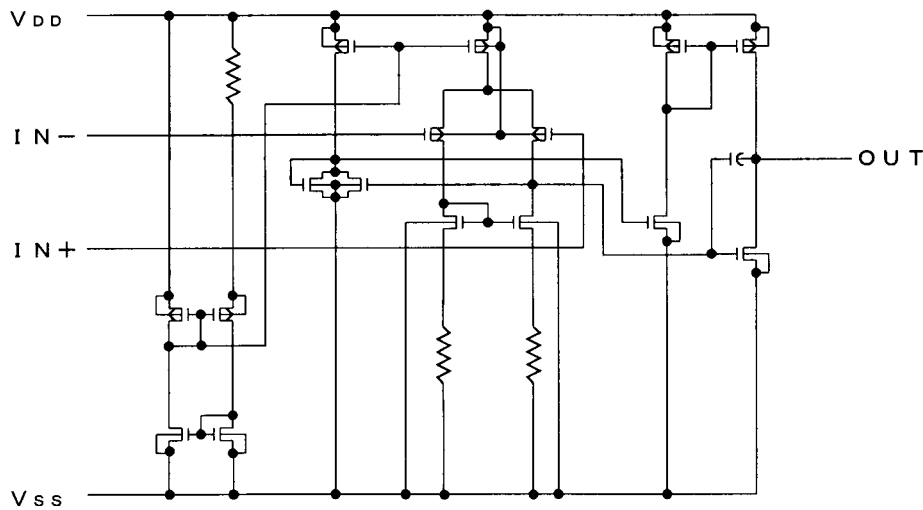

■ ABSOLUTE MAXIMUM RATINGS

(Ta=25°C)

PARAMETER	SYMBOL	RATINGS	UNIT
Supply Voltage	V _{DD}	7	V
Differential Input Voltage	V _{ID}	±7 (note1)	V
Common Mode Input Voltage	V _{IC}	-0.3~7	V
Power Dissipation	P _D	(DIP8) 500 (DMP8) 300 (SSOP8) 250 (MSOP8(VSP8)) 320 (MSOP8(TVSP8)) 320	mW
Operating Temperature Range	T _{opr}	-40~+85	°C
Storage Temperature Range	T _{stg}	-55~+125	°C

(note1) If the supply voltage (V_{DD}) is less than 7V, the input voltage must not over the V_{DD} level though 7V is limit specified.

(note2) Decoupling capacitor should be connected between V_{DD} and V_{SS} due to the stabilized operation for the circuit.

■ ELECTRICAL CHARACTERISTICS

NJU7014

(Ta=25°C, V_{DD}=3.0V, R_L=∞)

PARAMETER	SYMBOL	TEST CONDITION	MIN.	TYP.	MAX.	UNIT
Input Offset Voltage	V _{IO}	V _{IN} =1/2V _{DD}	-	-	10	mV
Input Offset Current	I _{IO}		-	1	-	pA
Input Bias Current	I _{IB}		-	1	-	pA
Input Impedance	R _{IN}		-	1	-	TΩ
Large Signal Voltage Gain	A _{VD}		60	70	-	dB
Input Common Mode Voltage Range	V _{ICM}		0~2.5	-	-	V
Maximum Output Swing Voltage	V _{OM1}	R _L =1MΩ	V _{DD} -0.1	-	-	V
	V _{OM2}	R _L =1MΩ	-	-	V _{SS} +0.1	V
Common Mode Rejection Ratio	CMR	V _{IN} =1/2V _{DD}	55	65	-	dB
Supply Voltage Rejection Ratio	SVR	V _{DD} =1.5~5.5V	60	70	-	dB
Operating Current	I _{DD}	Per Circuit	-	15	25	μA
Slew Rate	SR		-	0.1	-	V/μs
Unity Gain Bandwidth	F _T	A _V =40dB, C _L =10pF	-	0.2	-	MHz

(note3) The source current is less than 2.9μA (at V_{OM}/R_L=2.9V/1MΩ).

NJU7015

(Ta=25°C, V_{DD}=3.0V, R_L=∞)

PARAMETER	SYMBOL	TEST CONDITION	MIN.	TYP.	MAX.	UNIT
Input Offset Voltage	V _{IO}	V _{IN} =1/2V _{DD}	-	-	10	mV
Input Offset Current	I _{IO}		-	1	-	pA
Input Bias Current	I _{IB}		-	1	-	pA
Input Impedance	R _{IN}		-	1	-	TΩ
Large Signal Voltage Gain	A _{VD}		60	70	-	dB
Input Common Mode Voltage Range	V _{ICM}		0~2.5	-	-	V
Maximum Output Swing Voltage	V _{OM1}	R _L =100kΩ	V _{DD} -0.1	-	-	V
	V _{OM2}	R _L =100kΩ	-	-	V _{SS} +0.1	V
Common Mode Rejection Ratio	CMR	V _{IN} =1/2V _{DD}	55	65	-	dB
Supply Voltage Rejection Ratio	SVR	V _{DD} =1.5~5.5V	60	70	-	dB
Operating Current	I _{DD}	Per Circuit	-	80	160	μA
Slew Rate	SR		-	1.0	-	V/μs
Unity Gain Bandwidth	F _t	A _V =40dB, C _L =10pF	-	1.0	-	MHz

(note4) The source current is less than 29μA (at V_{OM}/R_L=2.9V/100kΩ).

NJU7016

(Ta=25°C, V_{DD}=3.0V, R_L=∞)

PARAMETER	SYMBOL	TEST CONDITION	MIN.	TYP.	MAX.	UNIT
Input Offset Voltage	V _{IO}	V _{IN} =1/2V _{DD}	-	-	10	mV
Input Offset Current	I _{IO}		-	1	-	pA
Input Bias Current	I _{IB}		-	1	-	pA
Input Impedance	R _{IN}		-	1	-	TΩ
Large Signal Voltage Gain	A _{VD}		60	70	-	dB
Input Common Mode Voltage Range	V _{ICM}		0~2.5	-	-	V
Maximum Output Swing Voltage	V _{OM1}	R _L =50kΩ	V _{DD} -0.1	-	-	V
	V _{OM2}	R _L =50kΩ	-	-	V _{SS} +0.1	V
Common Mode Rejection Ratio	CMR	V _{IN} =1/2V _{DD}	55	65	-	dB
Supply Voltage Rejection Ratio	SVR	V _{DD} =1.5~5.5V	60	70	-	dB
Operating Current	I _{DD}	Per Circuit	-	200	400	μA
Slew Rate	SR		-	1.0	-	V/μs
Unity Gain Bandwidth	F _t	A _V =40dB, C _L =10pF	-	1.0	-	MHz

(note5) The source current is less than 58μA (at V_{OM}/R_L=2.9V/50kΩ).

■ TYPICAL CHARACTERISTICS

(1) NJU7014

Output Voltage vs. Output Current (SOURCE)

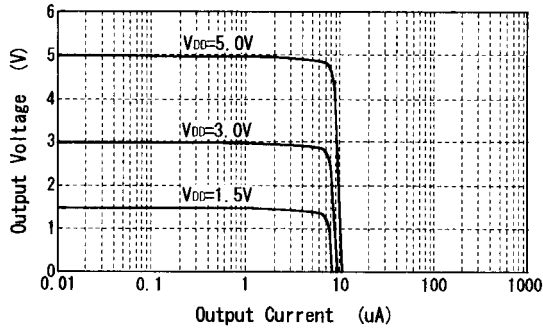

Output Voltage vs. Output Current (SINK)

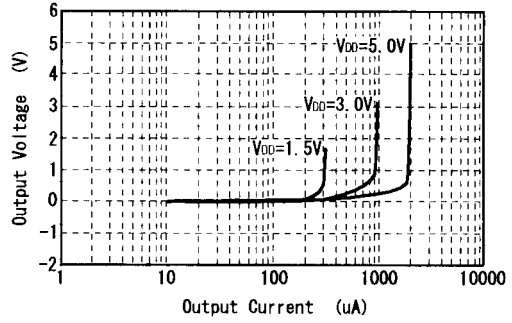

Operating Current vs. Operating Voltage

V_{IN}=0.1V

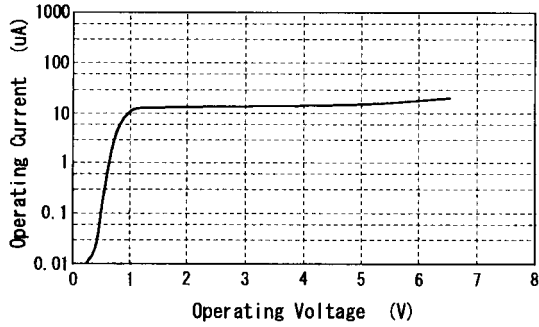

Output Current vs. Operating Voltage

V_{IN}=0.1V

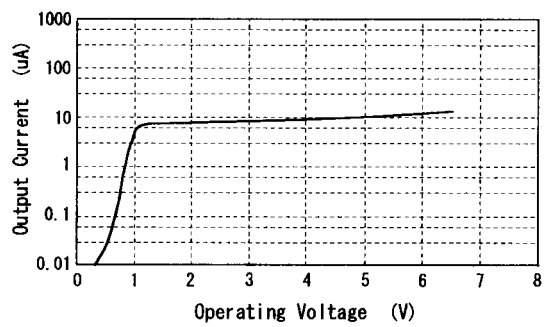

Maximum Output Swing Voltage vs. Load Resistance

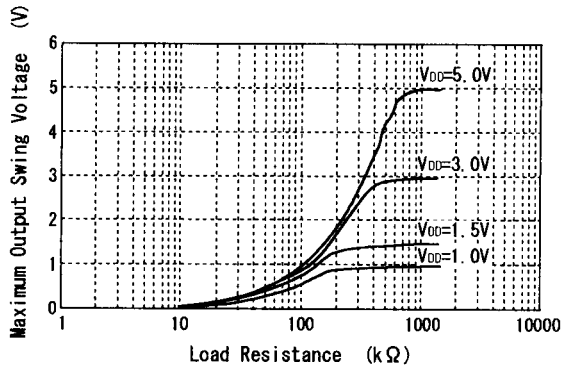

Maximum Output Swing Voltage vs. Frequency

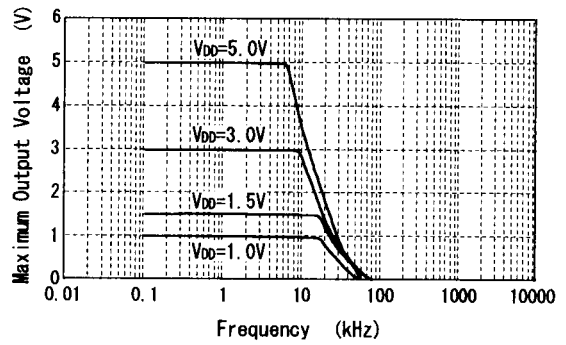

Voltage Gain-Phase vs. Frequency

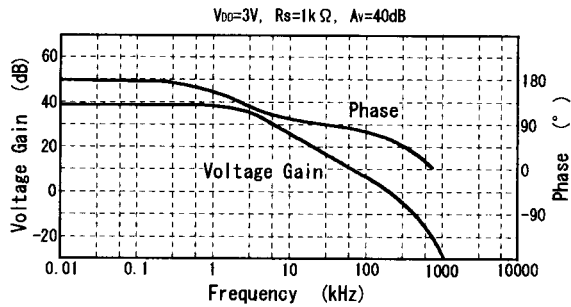

(2) NJU7015

Output Voltage vs. Output Current (SOURCE)

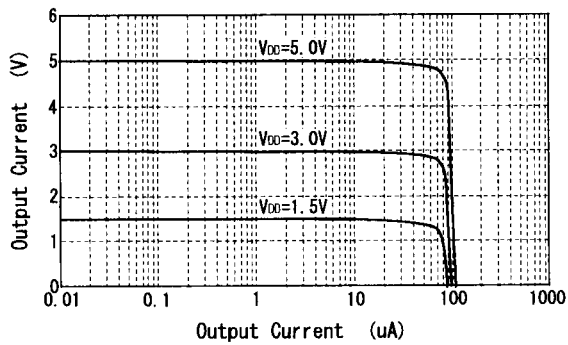

Output Voltage vs. Output Current (SINK)

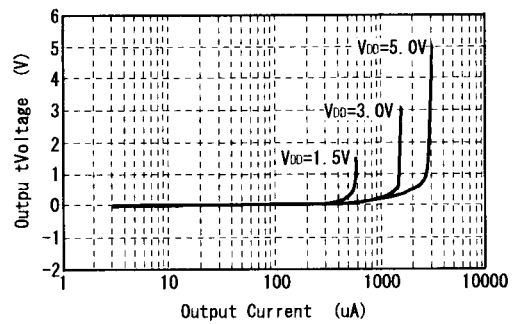

Operating Current vs. Operating Voltage

V_{IN}=0.1V

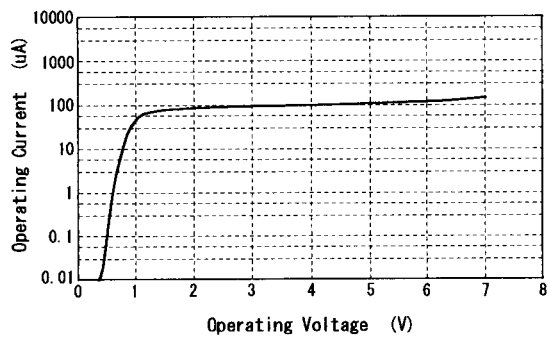

Output Current vs. Operating Voltage

V_{IN}=0.1V

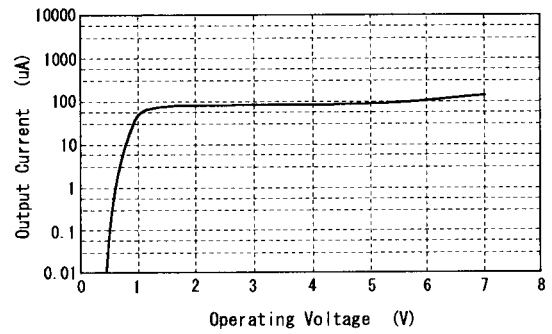

Maximum Output Swing Voltage vs. Load Resistance

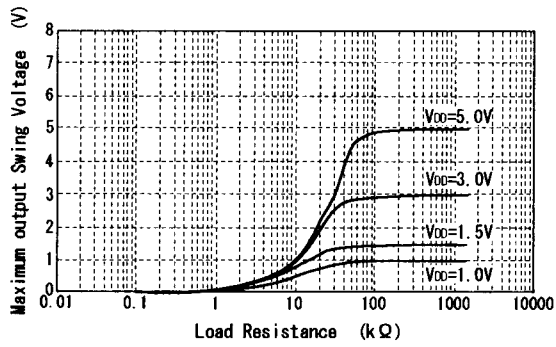

Maximum Output Swing Voltage vs. Frequency

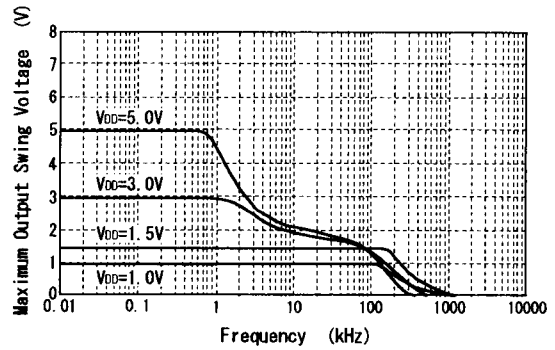

Voltage Gain-Phase vs. Frequency

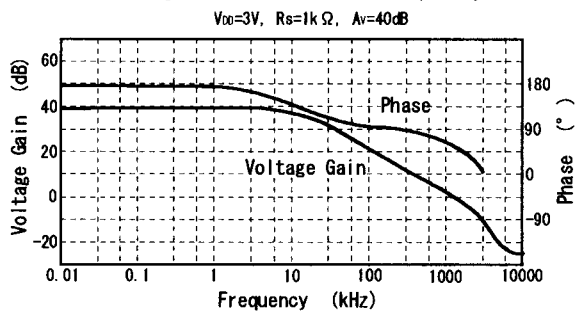

(3) NJU7016

Output Voltage vs. Output Current (SOURCE)

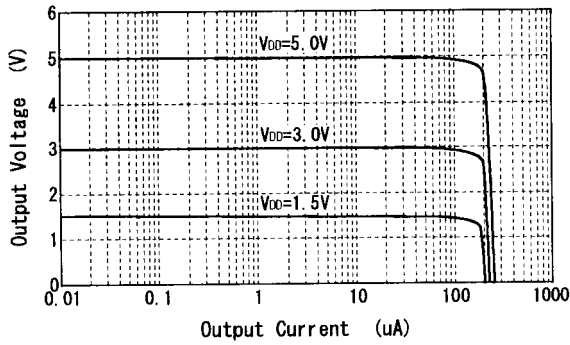

Output Voltage vs. Output Current (SINK)

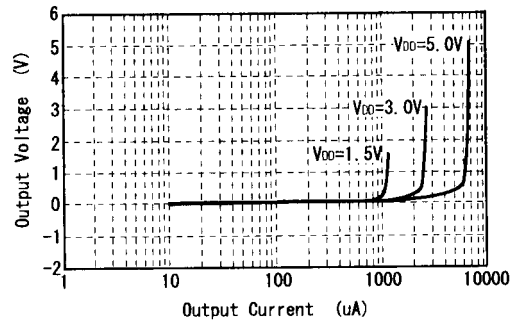

Operating Current vs. Operating Voltage

V_{IN}=0.1V

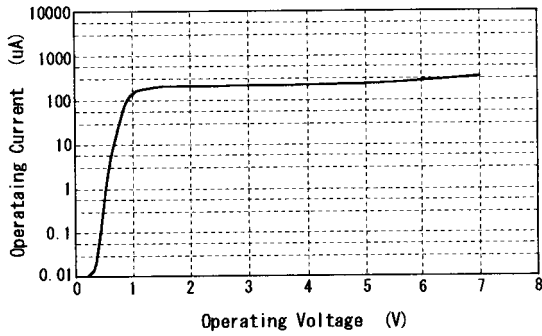

Output Current vs. Operating Voltage

V_{IN}=0.1V

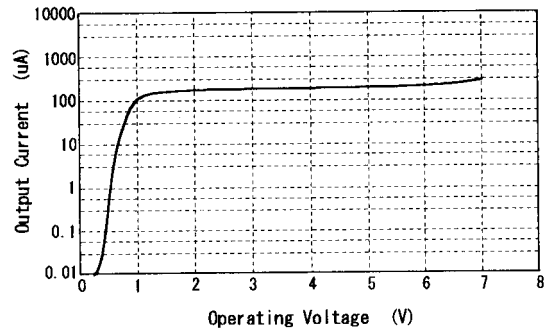

Maximum Output Swing Voltage vs. Load Resistance

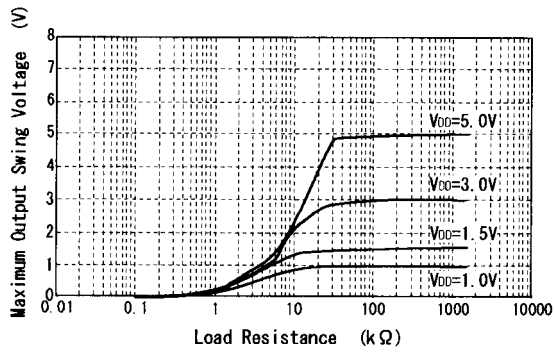

Maximum Output Swing Voltage vs. Frequency

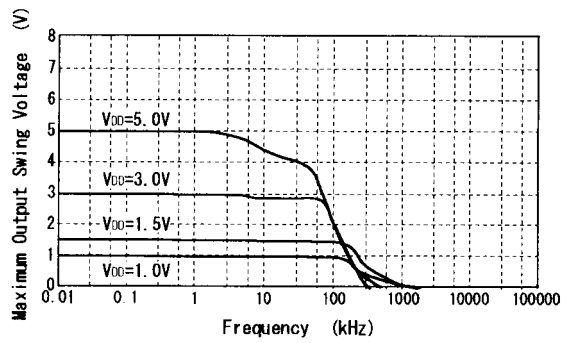

Voltage Gain·Phase vs. Frequency

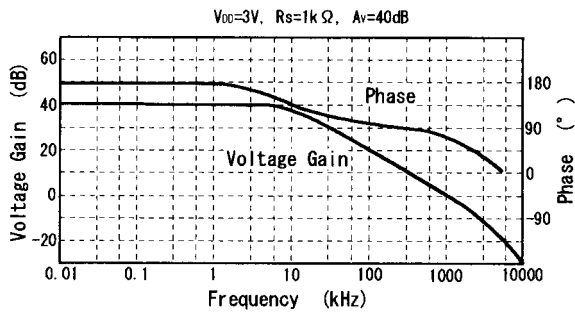

[CAUTION]

The specifications on this databook are only given for information, without any guarantee as regards either mistakes or omissions. The application circuits in this databook are described only to show representative usages of the product and not intended for the guarantee or permission of any right including the industrial rights.

Mouser Electronics

Authorized Distributor

Click to View Pricing, Inventory, Delivery & Lifecycle Information:

[NJR:](#)

[NJU7014D](#) [NJU7014M](#) [NJU7015M-TE1](#) [NJU7014M-TE1](#) [NJU7015D](#) [NJU7015M](#) [NJU7014V-TE1](#) [NJU7015RB1-TE1](#) [NJU7014RB1-TE1](#) [NJU7014R-TE1](#) [NJU7014R-TE2](#) [NJU7015R-TE1](#) [NJU7015R-TE2](#) [NJU7015V-TE1](#)



Компания «ЭлектроПласт» предлагает заключение долгосрочных отношений при поставках импортных электронных компонентов на взаимовыгодных условиях!

Наши преимущества:

- Оперативные поставки широкого спектра электронных компонентов отечественного и импортного производства напрямую от производителей и с крупнейших мировых складов;
- Поставка более 17-ти миллионов наименований электронных компонентов;
- Поставка сложных, дефицитных, либо снятых с производства позиций;
- Оперативные сроки поставки под заказ (от 5 рабочих дней);
- Экспресс доставка в любую точку России;
- Техническая поддержка проекта, помощь в подборе аналогов, поставка прототипов;
- Система менеджмента качества сертифицирована по Международному стандарту ISO 9001;
- Лицензия ФСБ на осуществление работ с использованием сведений, составляющих государственную тайну;
- Поставка специализированных компонентов (Xilinx, Altera, Analog Devices, Intersil, Interpoint, Microsemi, Aeroflex, Peregrine, Syfer, Eurofarad, Texas Instrument, Miteq, Cobham, E2V, MA-COM, Hittite, Mini-Circuits, General Dynamics и др.);

Помимо этого, одним из направлений компании «ЭлектроПласт» является направление «Источники питания». Мы предлагаем Вам помощь Конструкторского отдела:

- Подбор оптимального решения, техническое обоснование при выборе компонента;
- Подбор аналогов;
- Консультации по применению компонента;
- Поставка образцов и прототипов;
- Техническая поддержка проекта;
- Защита от снятия компонента с производства.



Как с нами связаться

Телефон: 8 (812) 309 58 32 (многоканальный)

Факс: 8 (812) 320-02-42

Электронная почта: org@eplast1.ru

Адрес: 198099, г. Санкт-Петербург, ул. Калинина, дом 2, корпус 4, литера А.