

LOC		DIST		REVISIONS			
P	LTN	DESCRIPTION	DATE	DWN	APVD		
	H4	ADDED DASH NUMBER -33	25FEB2013	CZ	SZ		

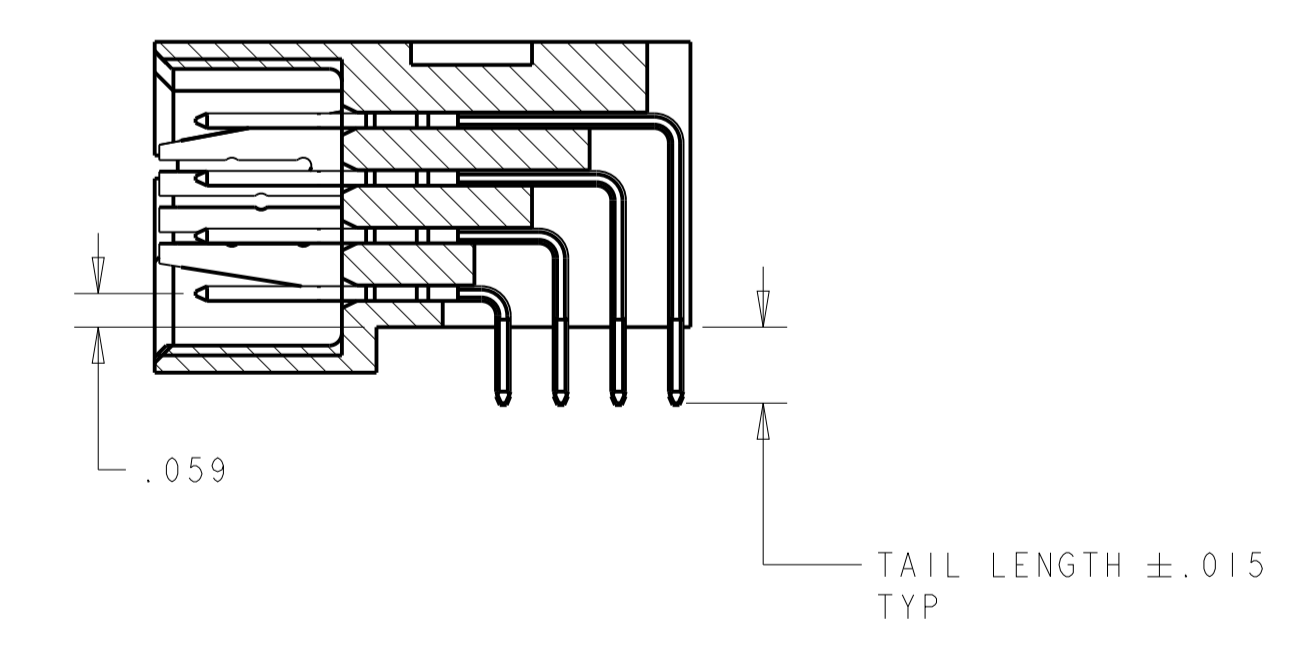
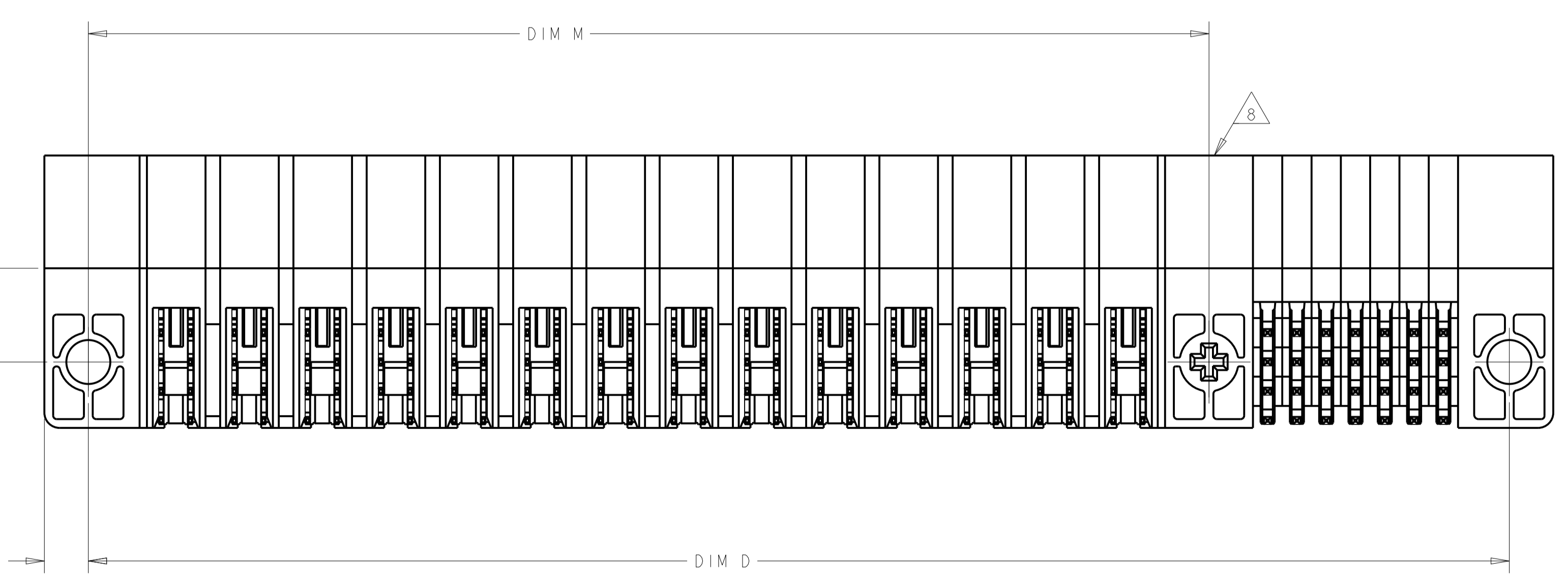
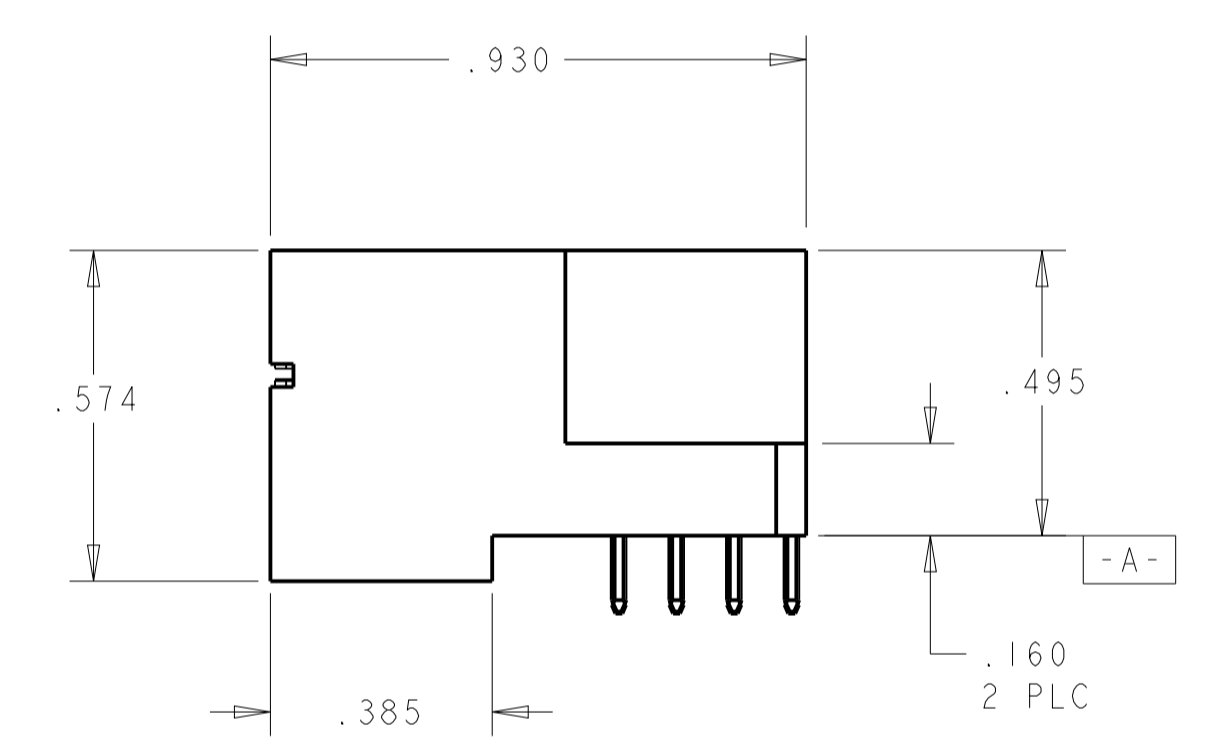
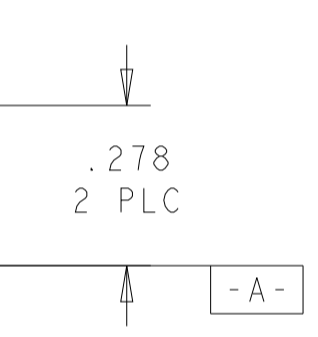
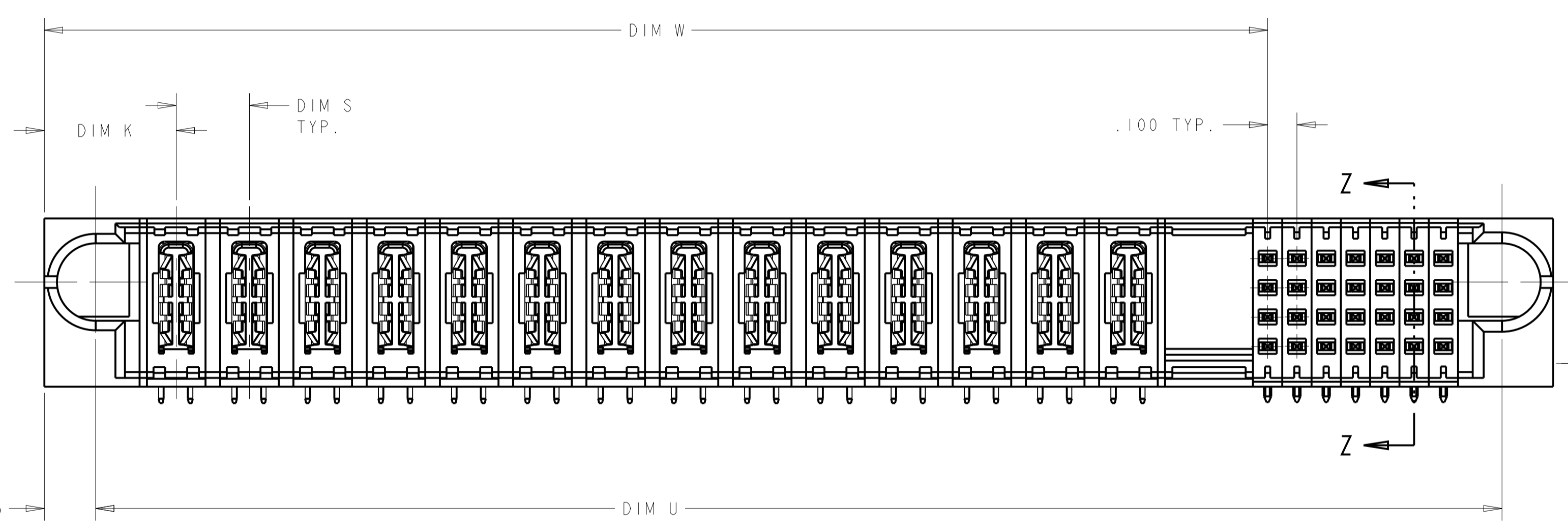
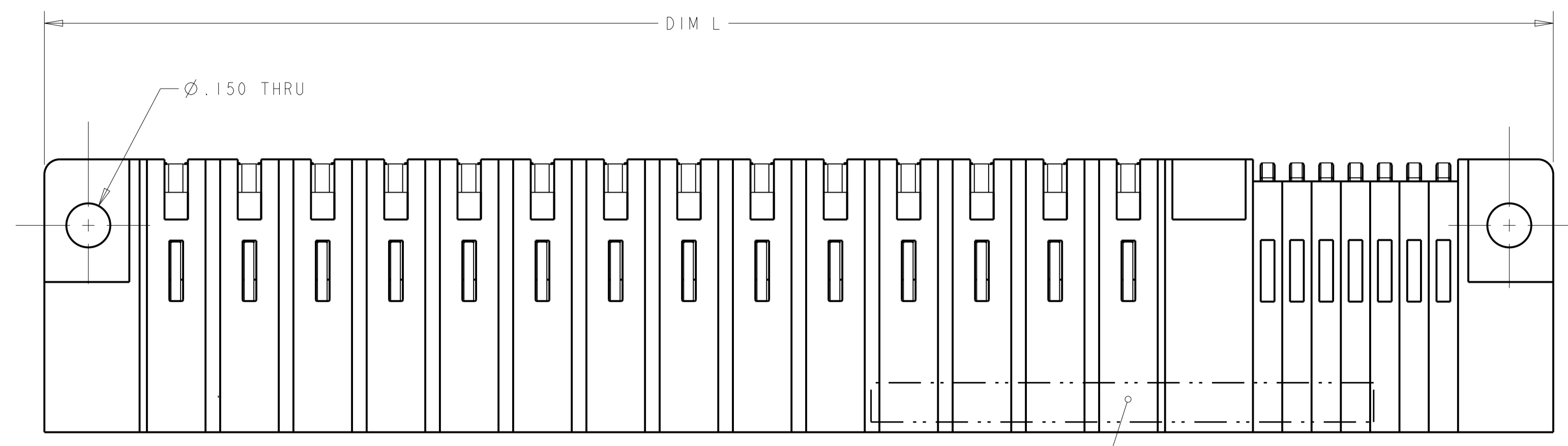

SECTION Z-Z

THIS DRAWING IS A CONTROLLED DOCUMENT.		DWN R. GRZYBOWSKI 24JAN05	TE Connectivity	
DIMENSIONS: INCHES		CHK M. PERCHERKE 24JAN05	NAME RIGHT ANGLE SOLDER HEADER ASSEMBLY MULTI-BEAM XL	
TOLERANCES UNLESS OTHERWISE SPECIFIED:		APVD M. PERCHERKE	PRODUCT SPEC	
0 PLC $\pm .01$ 1 PLC $\pm .01$ 2 PLC $\pm .01$ 3 PLC $\pm .005$ 4 PLC $\pm .002$ ANGLES $\pm .020$		APPLICATION SPEC		
MATERIAL		FINISH	SIZE A100779	CAGE CODE 6450332
CUSTOMER DRAWING		WEIGHT	SCALE 4:1	SHEET 1 OF 13

LOC	DIST	REV	DATE	BY	APPR
ES	00				

- 1 "AMP", PART NUMBER, AND DATECODE TO BE MARKED IN AREA SHOWN.
- 2 MATERIAL: HOUSING - GLASS FILLED HIGH TEMP THERMO PLASTIC, UL94 V-0
SIGNAL CONTACT - COPPER ALLOY
POWER CONTACT - HIGH CONDUCTIVITY COPPER ALLOY
- 3 CONTACT PLATING: NOBLE METAL PLATING ON CONTACT FUNCTIONAL AREA OF POWER AND SIGNAL CONTACTS
- 4 MECHANICAL CONNECTOR KEEP OUT ZONE.
- 5 DATUM AND BASIC DIMENSIONS ESTABLISHED BY CUSTOMER.
- 6 PCB - HOLE DIAMETERS ARE FINISHED HOLE SIZE.
- 7 PCB - .0453±.0010 DRILLED HOLES PLATED WITH .0003 MIN Sn OVER .001 TO .003 Cu PLATING TO ACHIEVE A .040 DIAMETER HOLE.
- 8 OPTIONAL CENTER MODULE
- 9 NOT RELEASED FOR PRODUCTION
- 10 VARIABLE DIMENSIONS SHOWN ON TABLE

DIM U	DIM S	DIM W	DIM D	DIM M	DIM L	DIM K	DESCRIPTION	PART NUMBER
1.900	.250	1.375	1.950	-	2.250	.450	4P + 24S	3-6450332-4
2.825	△	2.300	2.875	-	3.175	.475	3ACP + 4P + 24S	3-6450332-3
1.600	.250	1.375	1.650	-	1.950	.450	4P + 12S	3-6450332-2
2.825	△	2.300	2.875	-	3.175	.475	3ACP + 4P + 24S	3-6450332-1
3.225	△	2.675	3.275	-	3.575	.525	9P + 24S	3-6450332-0
2.700	△	2.275	2.750	-	3.050	.450	4ACP+3P+20S	1-6450332-9
3.225	△	2.675	3.275	-	3.575	.525	3ACP+6P+24S	2-6450332-8
1.650	.200	1.225	1.700	-	2.000	.450	4P + 20S	2-6450332-6
1.800	△	1.275	1.850	-	2.150	.450	4P + 24S	2-6450332-5
2.900	.250	2.375	2.950	-	3.250	.450	8P + 24S	2-6450332-4
3.225	△	2.675	3.275	-	3.575	.525	3ACP+6P+24S	2-6450332-3
2.150	.250	1.625	2.200	-	2.500	.450	5P + 24S	2-6450332-0
3.225	△	2.675	3.275	-	3.575	.525	3ACP+6P+24S	6450332-9
3.875	△	3.550	3.925	-	4.225	.475	1ACP + 9P + 16S	1-6450332-8
2.300	.250	1.875	2.350	-	2.650	.450	6P+20S	1-6450332-7
3.875	△	3.550	3.925	-	4.225	.475	3ACP+9P+16S	1-6450332-6
5.100	△	2.375	5.150	-	5.450	.450	8P + 112S	1-6450332-4
3.800	△	3.175	3.850	-	4.150	.450	12P + 28S	1-6450332-3
2.275	△	2.050	2.325	-	2.625	.450	5P + 24S	1-6450332-2
1.400	.250	.875	1.450	-	1.750	.450	2P + 24S	6450332-8
1.100	-	.575	1.150	-	1.450	.425	1P + 24S	6450332-6
4.425	.250	3.875	4.475	-	4.775	.450	14P + 24S	6450332-5
2.675	.250	2.125	2.725	-	3.025	.450	7P + 24S	6450332-4
2.925	.250	2.375	2.975	-	3.275	.450	8P + 24S	6450332-3
4.500	.250	3.875	4.550	-	4.850	.450	14P + 28S	6450332-2

THIS DRAWING IS A CONTROLLED DOCUMENT.

DIMENSIONS: INCHES

TOLERANCES UNLESS OTHERWISE SPECIFIED:

0 PLC	±
1 PLC	±.01
2 PLC	±.01
3 PLC	±.005
4 PLC	±.0020
ANGLES	±.020

MATERIAL: - FINISH: -

APPROVED: M. PERCHERKE

DATE: 24 JAN 05

NAME: R. GRZYBOWSKI

PRODUCT SPEC: 108-1973

APPLICATION SPEC: 114-13038

SIZE: A1 CAGE CODE: 6450332 DRAWING NO: 100779

RESTRICTED TO: -

CUSTOMER DRAWING

SCALE: 4:1 SHEET 2 OF 13 REV: H6

TE Connectivity

RIGHT ANGLE SOLDER HEADER ASSEMBLY MULTI-BEAM XL

LOC	DIST	REV	DATE	APPV
ES	00			

REVISIONS			
REV	DATE	DESCRIPTION	APPV
-	-	SEE SHEET 1	-

ASSY PART NUMBER	ROWS	POWER														SIGNAL						
		P1	P2	P3	P4	P5	P6	P7	P8	P9	P10	P11	P12	P13	P14	1	2	3	4	5	6	7
6450332-2	D C B A	PM	PM	PM	PM	PM	PM	PM	PM	PM	PM	PM	PM	PM	E	E	E	E	E	E	E	E
14P + 28S															F	F	F	F	F	F	F	F
															G	G	G	G	G	G	G	G
															S	S	S	S	S	H	H	H

PART NUMBER	ROWS	POWER								SIGNAL					
		P1	P2	P3	P4	P5	P6	P7	P8	1	2	3	4	5	6
6450332-3	D C B A	PM	PM	PM	PM	PM	PM	PM	PM	J	J	J	J	E	E
8P + 24S										K	K	K	K	F	F
										N	N	N	N	G	G
										S	S	S	S	H	H

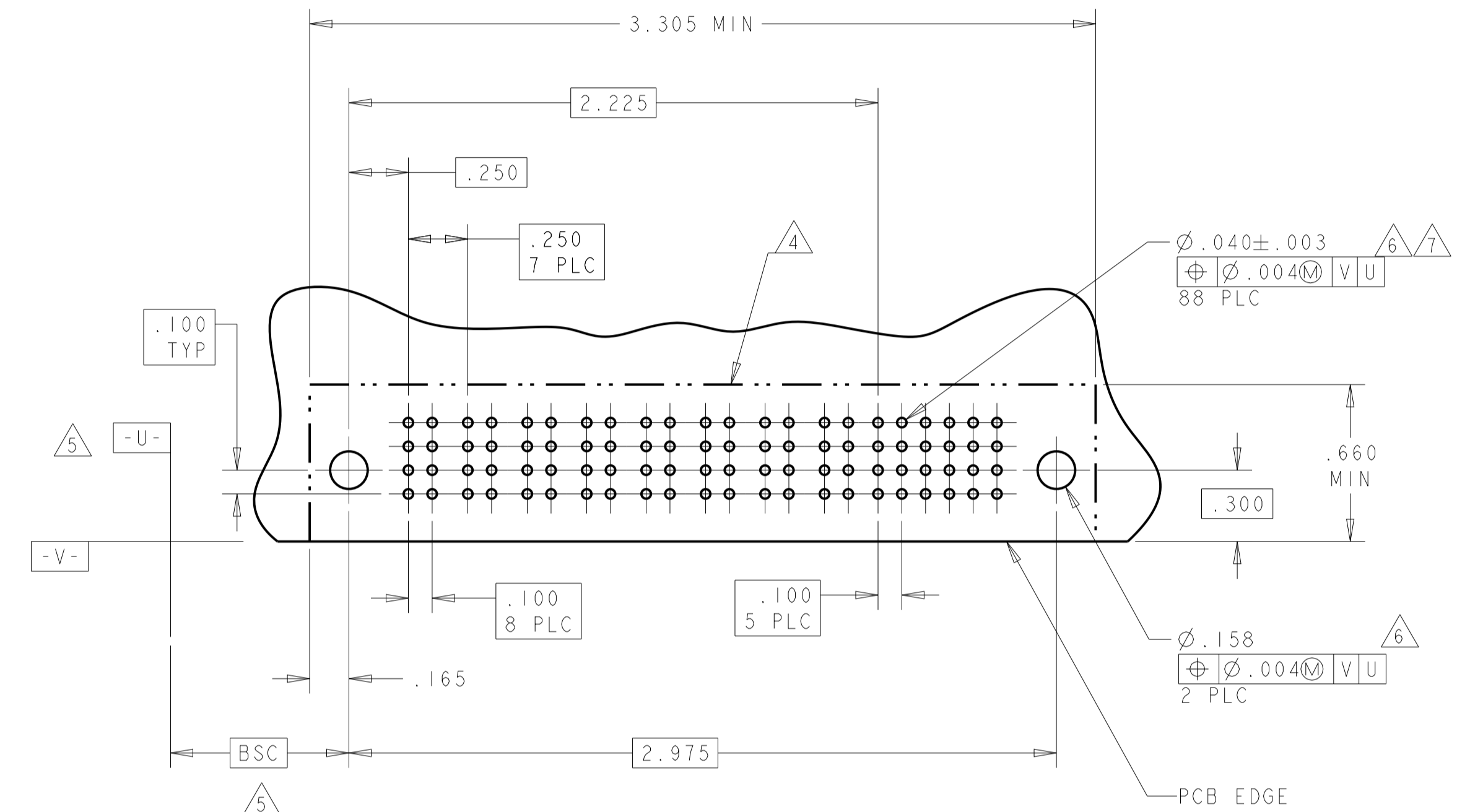
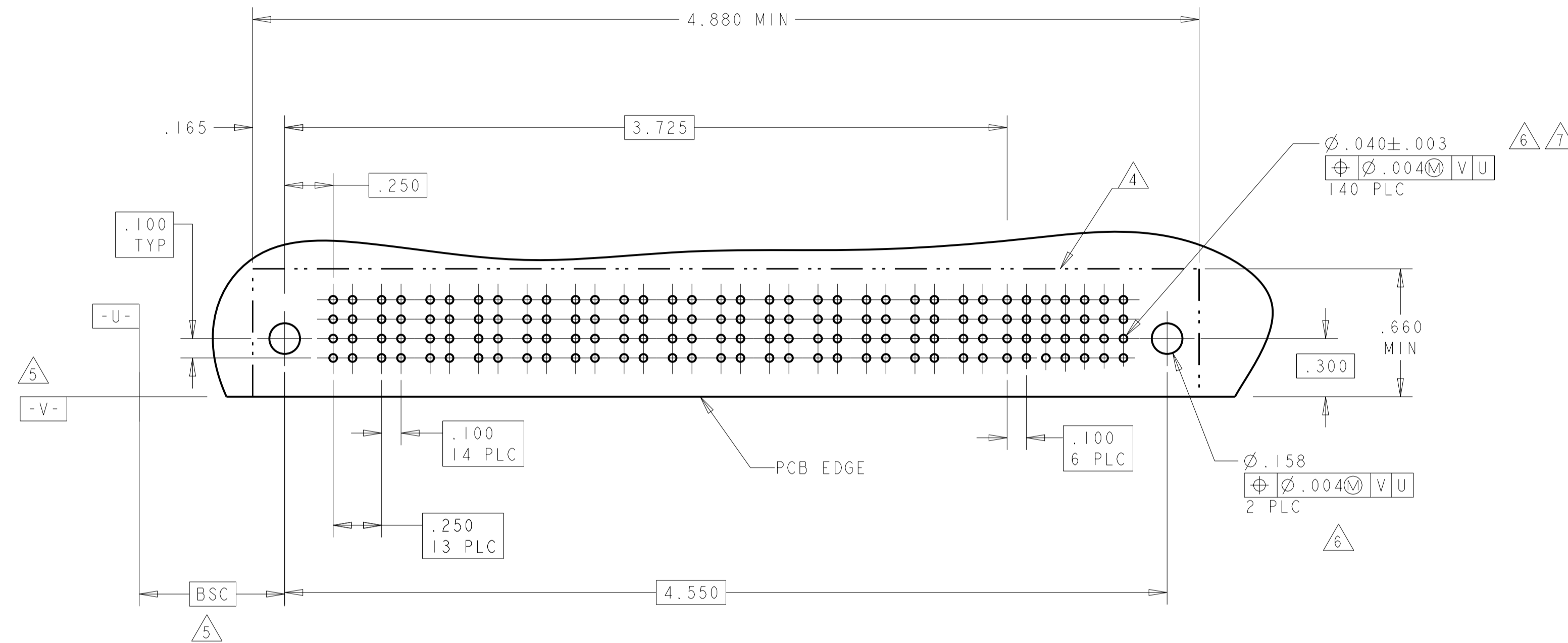

PART NUMBER	ROWS	POWER							SIGNAL					
		P1	P2	P3	P4	P5	P6	P7	1	2	3	4	5	6
6450332-4	D C B A	PM	PM	PM	PM	PM	PM	PM	J	J	E	J	J	J
7P + 24S									K	K	K	K	K	K
									N	N	N	N	N	N
									S	S	S	S	S	S

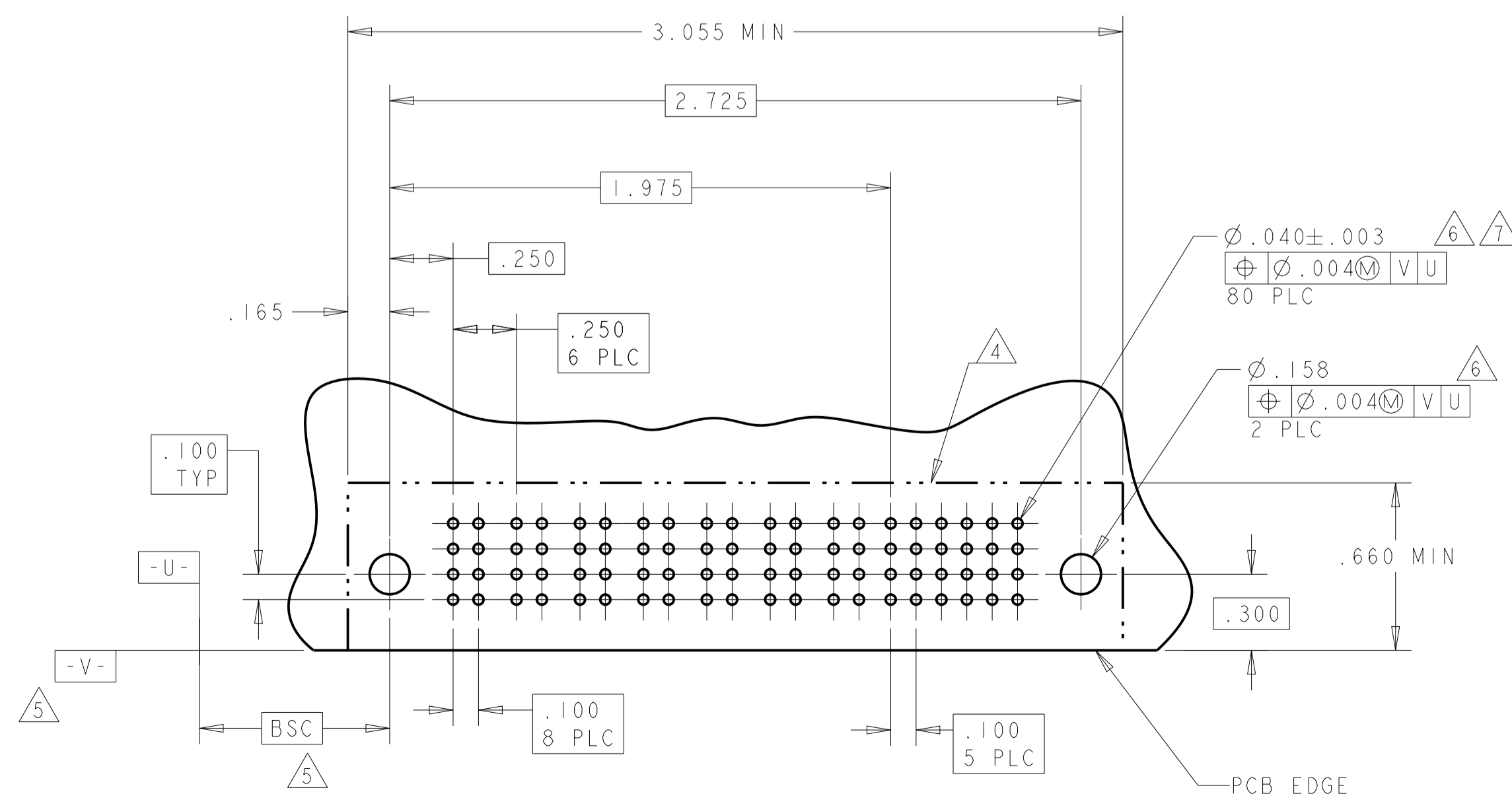

Z	STD	.090	D
Y	STD	.090	C
R	STD	.090	B
O	STD	.090	A
A4	MLBF	.090	D
A3	MLBF	.090	C
A2	MLBF	.090	B
A1	MLBF	.090	A
E	MLBF	.135	D
F	MLBF	.135	C
G	MLBF	.135	B
H	MLBF	.135	A
J	STD	.135	D
K	STD	.135	C
N	STD	.135	B
S	STD	.135	A

CODE	MATING SEQUENCE	TAIL LENGTH	ROW
PA		.090	
PM		.135	

CODE	TAIL LENGTH
PA	.090
PM	.135

THIS DRAWING IS A CONTROLLED DOCUMENT. DWN: B. GRZYBOWSKI 24JAN05, CHK: M. PERCHERKE 24JAN05, APPV: M. PERCHERKE

STE TE Connectivity

NAME: RIGHT ANGLE SOLDER HEADER ASSEMBLY MULTI-BEAM XL

PRODUCT SPEC: 108-1973, APPLICATION SPEC: 114-13038, CAGE CODE: 6450332, DRAWING NO: A100779

SCALE: 4:1, SHEET: 3 OF 13, REV: H6

LOC	DIST	REV	DATE	APPV
ES	00			

REVISIONS				
REV	DATE	APPV	DESCRIPTION	BY
-	-	-	SEE SHEET 1	-

PART NUMBER	ROWS	POWER														SIGNAL					
		P1	P2	P3	P4	P5	P6	P7	P8	P9	P10	P11	P12	P13	P14	1	2	3	4	5	6
6450332-5	D C B A	PM	PM	PM	PM	PM	PM	PM	PM	PM	PM	PM	PM	PM	PM	E	E	E	E	E	E
		PM	PM	PM	PM	PM	PM	PM	PM	PM	PM	PM	PM	PM	PM	F	F	F	F	F	F
		PM	PM	PM	PM	PM	PM	PM	PM	PM	PM	PM	PM	PM	PM	G	G	G	G	G	G
		PM	PM	PM	PM	PM	PM	PM	PM	PM	PM	PM	PM	PM	PM	H	H	S	S	H	H
14P + 24S																					

PART NUMBER	ROWS	POWER					SIGNAL							
		P1	P2	P3	P4	P5	1	2	3	4	5	6		
1-6450332-2	D C B A	PM	PM	PM	PM	PM								
		PM	PM	PM	PM	PM								
		PM	PM	PM	PM	PM								
		PM	PM	PM	PM	PM								
5P + 24S		NO CONTACTS LOADED												

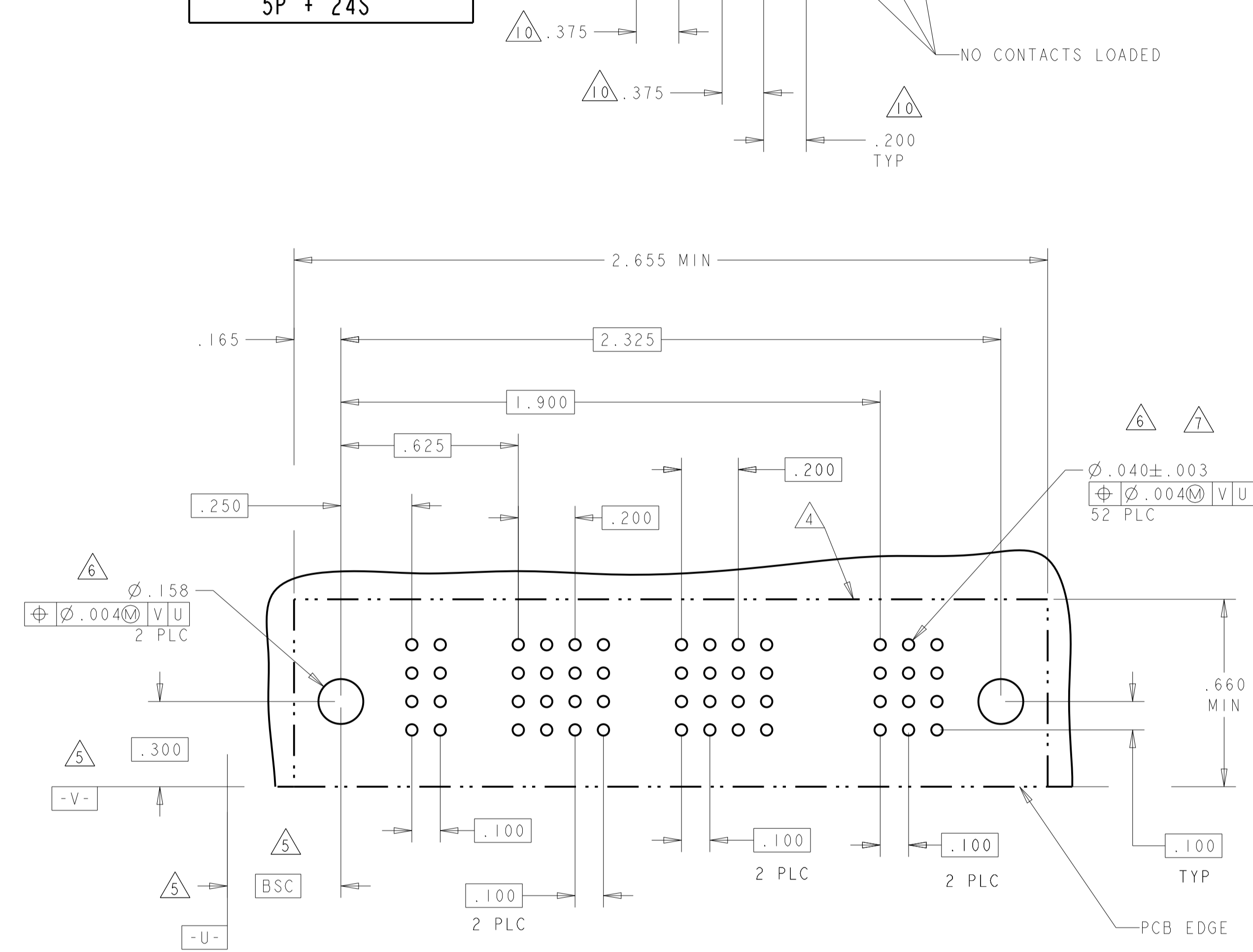
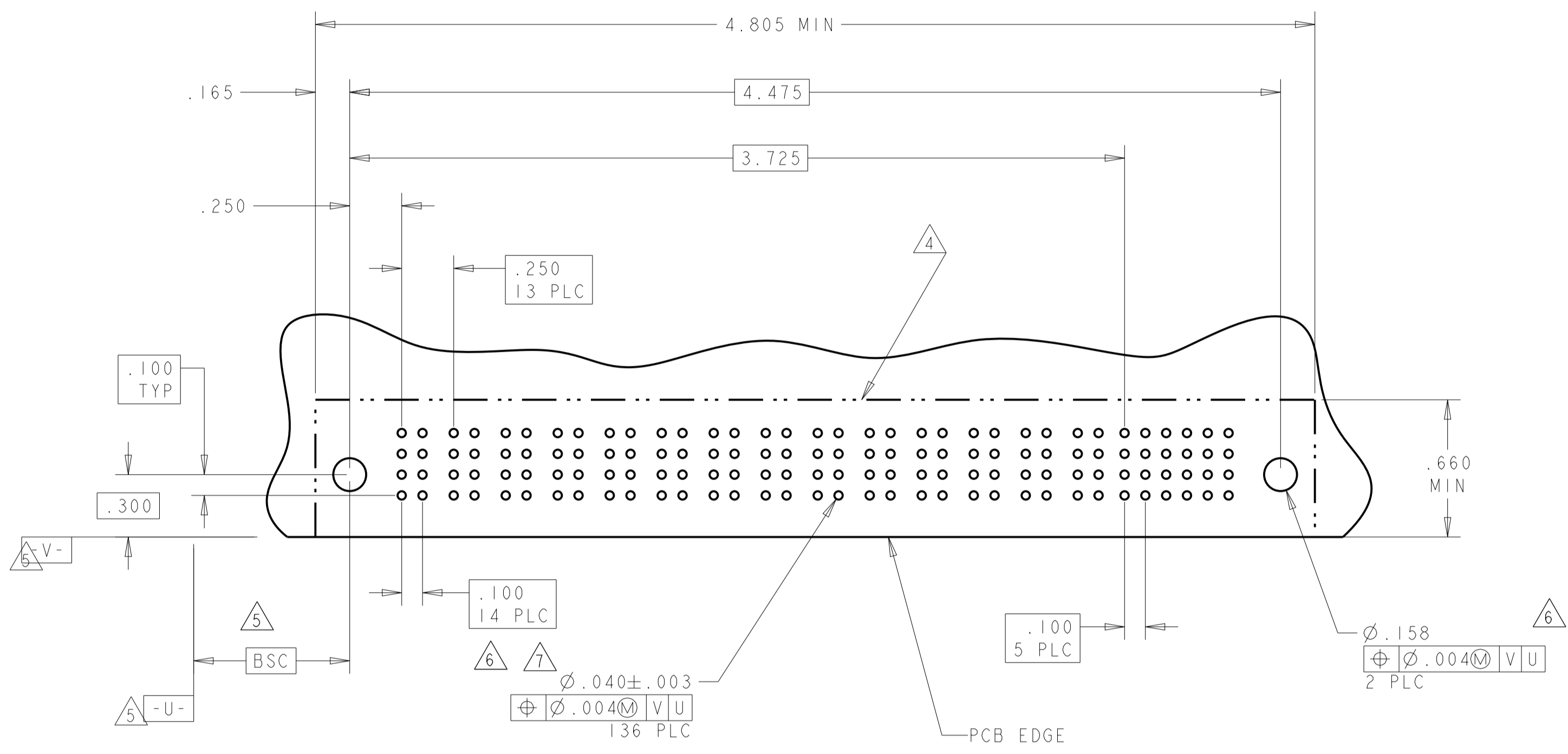

PART NUMBER	ROWS	POWER	SIGNAL					
		P1	1	2	3	4	5	6
6450332-6	D C B A	PM	E	E	E	E	E	J
		PM	F	F	F	F	F	F
		PM	G	G	G	G	G	G
		PM	H	H	H	H	H	H
1P + 24S								

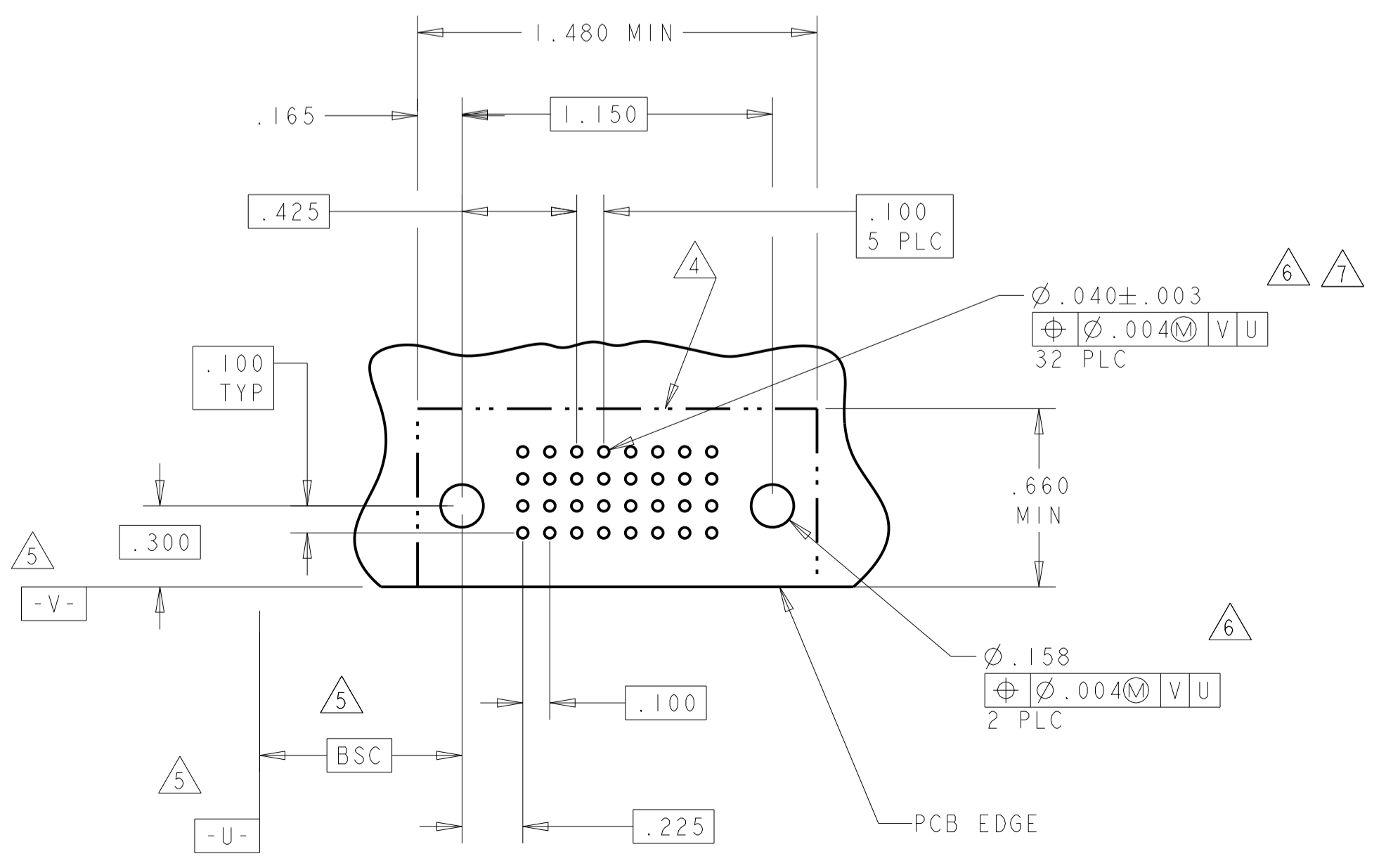

THIS DRAWING IS A CONTROLLED DOCUMENT.		OWN: R. GRZYBOWSKI 24JAN05	TE Connectivity	
DIMENSIONS: INCHES		CHK: M. PERCHERKE 24JAN05	NAME: RIGHT ANGLE SOLDER HEADER ASSEMBLY MULTI-BEAM XL	
TOLERANCES UNLESS OTHERWISE SPECIFIED:		APVD: M. PERCHERKE	PRODUCT SPEC: 108-1973	
0 PLC ±.01		APPLICATION SPEC: 114-13038	SIZE: CAGE CODE DRAWING NO: A100779	
1 PLC ±.01		WEIGHT: -	RESTRICTED TO: -	
2 PLC ±.01		FINISH: -	SCALE: 4:1 SHEET 4 OF 13 REV: H6	
3 PLC ±.005		CUSTOMER DRAWING	C=6450332	
4 PLC ±.002				
ANGLES: .0020				

LOC		DIST		REVISIONS			
ES	00	P	LTH	DESCRIPTION	DATE	DMN	APVD
				SEE SHEET 1			

PART NUMBER	ROWS	POWER												SIGNAL			
		P1	P2	P3	P4	P5	P6	P7	P8	P9	P10	P11	P12	1	2	3	4
I-6450332-6	D C B A	PM	PM	PM	PM	PM	PM	PM	PM	PM	PM	PM	PM	J	J	J	J
		PM	PM	PM	PM	PM	PM	PM	PM	PM	PM	PM	PM	K	K	K	K
		PM	PM	PM	PM	PM	PM	PM	PM	PM	PM	PM	PM	N	N	N	N
		PM	PM	PM	PM	PM	PM	PM	PM	PM	PM	PM	PM	S	S	S	H
3ACP + 9P + 16S																	

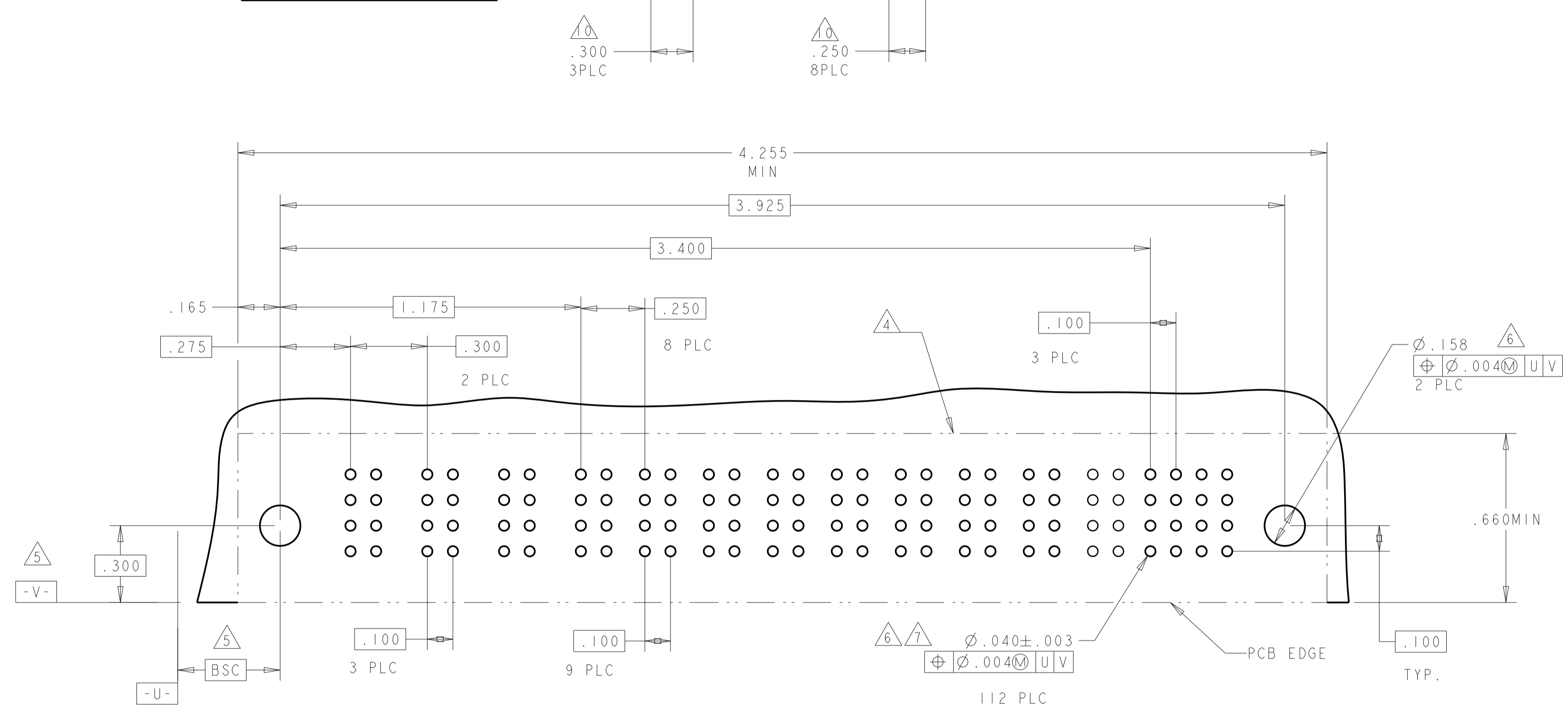

PART NUMBER	ROWS	POWER						SIGNAL				
		P1	P2	P3	P4	P5	P6	1	2	3	4	5
I-6450332-7	D C B A	PM	PM	PM	PM	PM	PM	J	J	J	J	J
		PM	PM	PM	PM	PM	PM	K	K	K	K	K
		PM	PM	PM	PM	PM	PM	N	N	N	N	N
		PM	PM	PM	PM	PM	PM	H	S	S	S	S
6P + 20S												

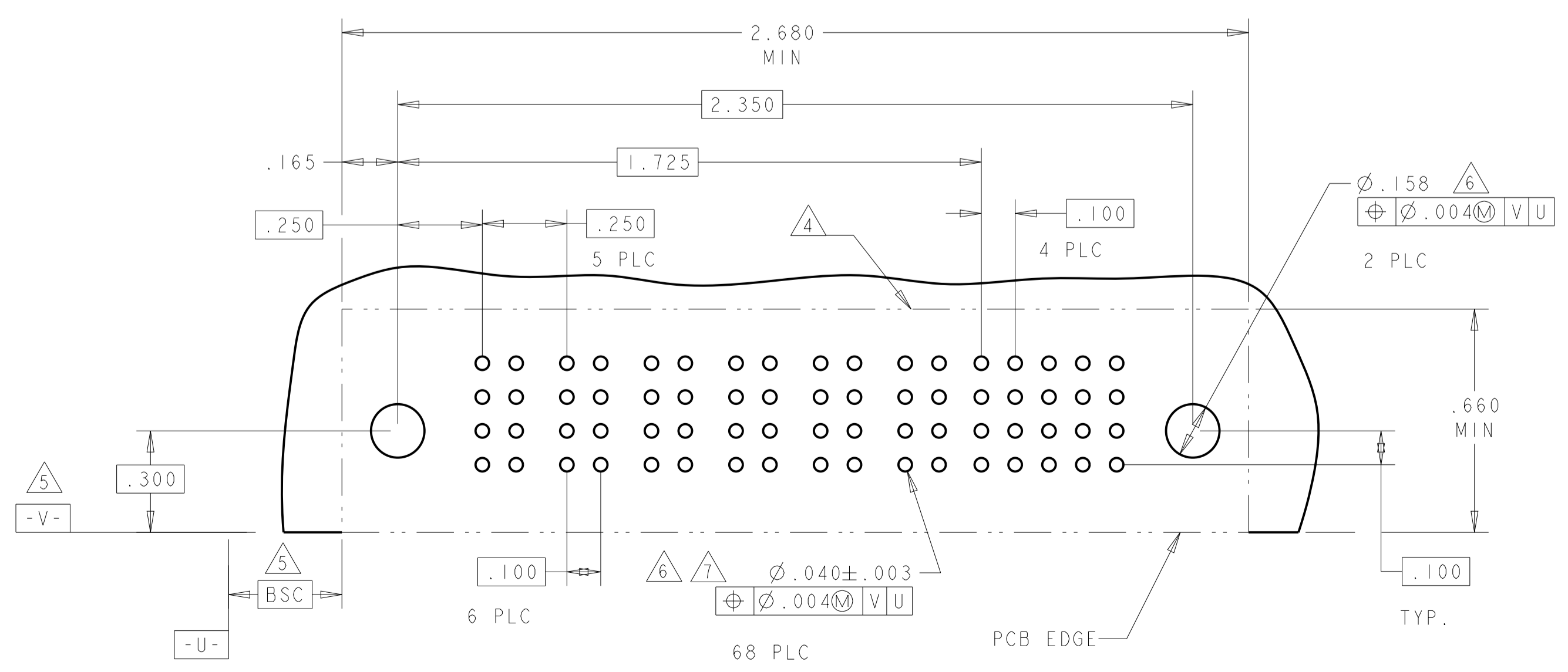

(B1) ADD SHEET 5 OF 6

THIS DRAWING IS A CONTROLLED DOCUMENT.		DMN: R. GRZYBOWSKI 24JAN05	TE Connectivity
DIMENSIONS: INCHES		CHK: M. PERCHERKE 24JAN05	
		TOLERANCES UNLESS OTHERWISE SPECIFIED:	NAME: RIGHT ANGLE SOLDER HEADER ASSEMBLY MULTI-BEAM XL
MATERIAL:		APVD: M. PERCHERKE	PRODUCT SPEC: 108-1973
FINISH:		APPLICATION SPEC: 114-13038	SIZE: A1
CUSTOMER DRAWING		WEIGHT:	CAGE CODE: 6450332
SCALE: 4:1		SHEET: 6 OF 13	REV: H6

LOC		DIST		REVISIONS				
ES	00	P	LTN	DESCRIPTION	DATE	DWN	APVD	
				SEE SHEET 1				

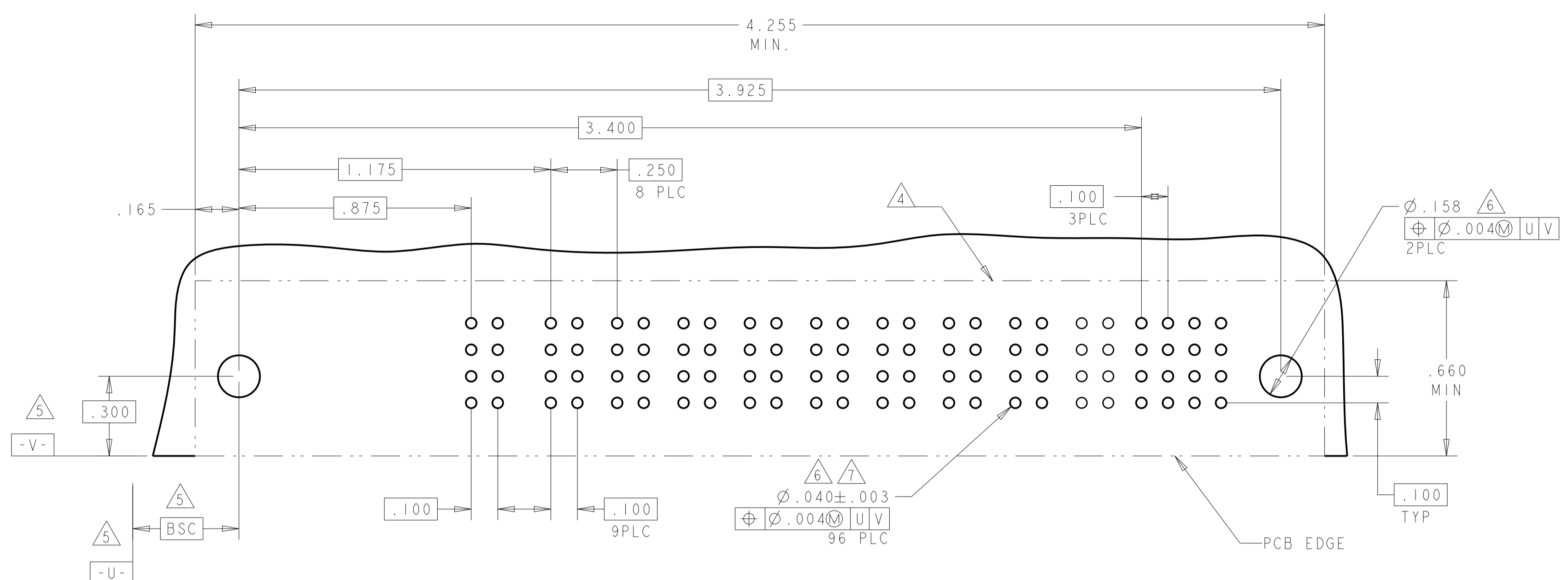

PART NUMBER	ROWS	POWER										SIGNAL					
		P1	P2	P3	P4	P5	P6	P7	P8	P9	P10	P11	P12	1	2	3	4
1-6450332-8	D													J	J	J	J
	C													K	K	K	K
	B													N	N	N	N
A														S	S	S	H
IACP + 9P + 16S																	

PART NUMBER	ROWS	POWER								SIGNAL						
		P1	P2	P3	P4	P5	P6	P7	P8	P9	1	2	3	4	5	6
6450332-9	D										J	E	J	J	J	E
	C										K	K	K	K	F	F
	B										N	N	N	N	G	G
	A										S	S	S	S	H	S
3ACP + 6P + 24S																

PART NUMBER	ROWS	POWER									SIGNAL					
		P1	P2	P3	P4	P5	P6	P7	P8	P9	1	2	3	4	5	6
2-6450332-3	D										E	E	E	E	E	E
	C										K	F	F	F	F	F
	B										N	G	G	G	G	G
	A										H	H	H	H	H	S
3ACP + 6P + 24S																

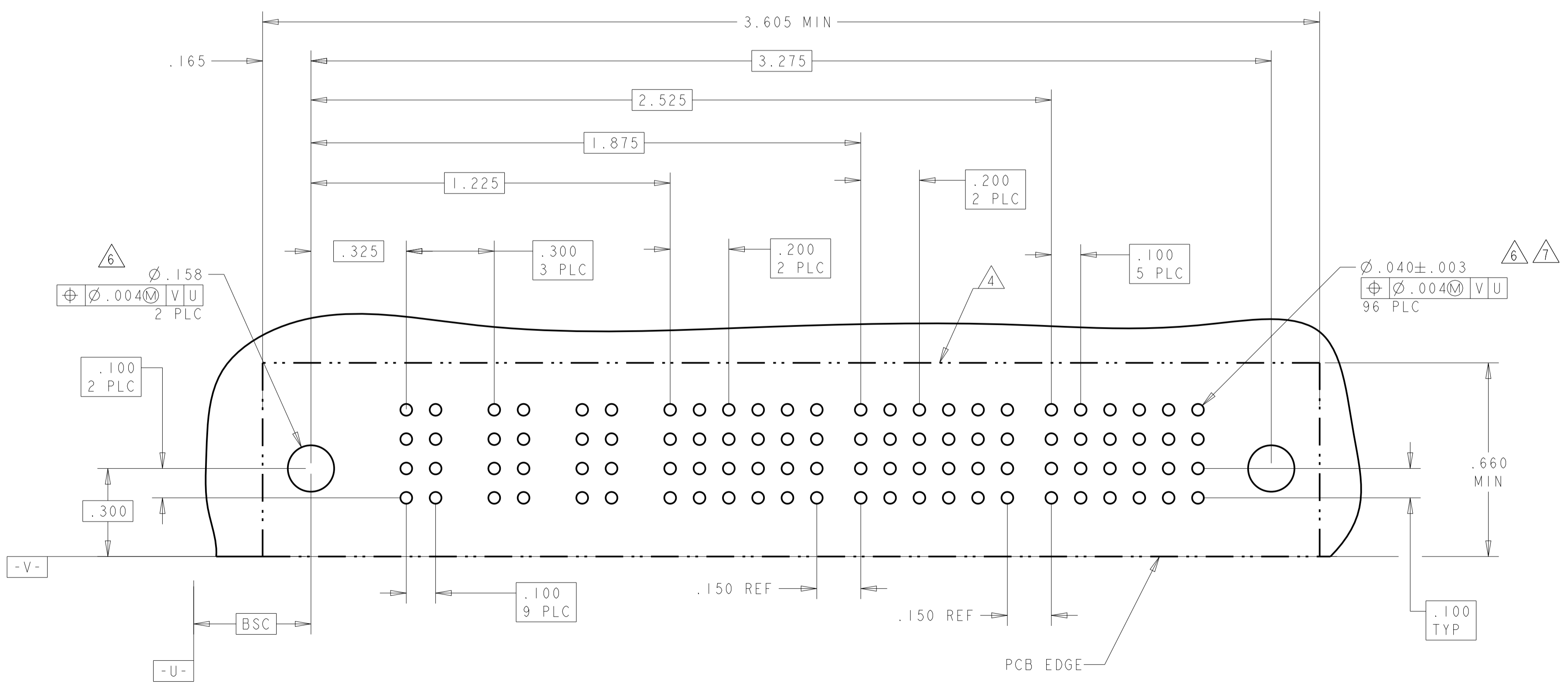

PART NUMBER 6450332-9 & 2-6450332-3 PCB LAYOUT

THIS DRAWING IS A CONTROLLED DOCUMENT. OWN: R. GRZYBOWSKI, 24JAN05. CHK: M. PERCHERKE, 24JAN05. APVD: M. PERCHERKE. NAME: RIGHT ANGLE SOLDER HEADER ASSEMBLY MULTI-BEAM XL. PRODUCT SPEC: 108-1973. APPLICATION SPEC: 114-13038. WEIGHT: -. MATERIAL: -. FINISH: -. DIMENSIONS: INCHES. TOLERANCES UNLESS OTHERWISE SPECIFIED: 0 PLC ±. 1 PLC ±.01. 2 PLC ±.01. 3 PLC ±.005. 4 PLC ±.002. ANGLES: .002. THIS DRAWING IS UNPUBLISHED. RELEASED FOR PUBLICATION. COPYRIGHT 20 BY ALL RIGHTS RESERVED. 4805 (3/11)

SCALE	4:1	SHEET	7	OF	13	REV	H6
-------	-----	-------	---	----	----	-----	----

LOC	DIST	REV	DATE	BY	APPV
ES	00				

PART NUMBER	ROWS	POWER								SIGNAL					
		P1	P2	P3	P4	P5	P6	P7	P8	1	2	3	4	5	6
2-6450332-4	D C B A	PM	PM	PM	PM	PM	PM	PM	PM	J	J	J	J	E	E
		PM	PM	PM	PM	PM	PM	PM	PM	K	K	K	K	F	F
		PM	PM	PM	PM	PM	PM	PM	PM	N	N	N	N	G	G
8P + 24S									S	S	S	S	H	H	

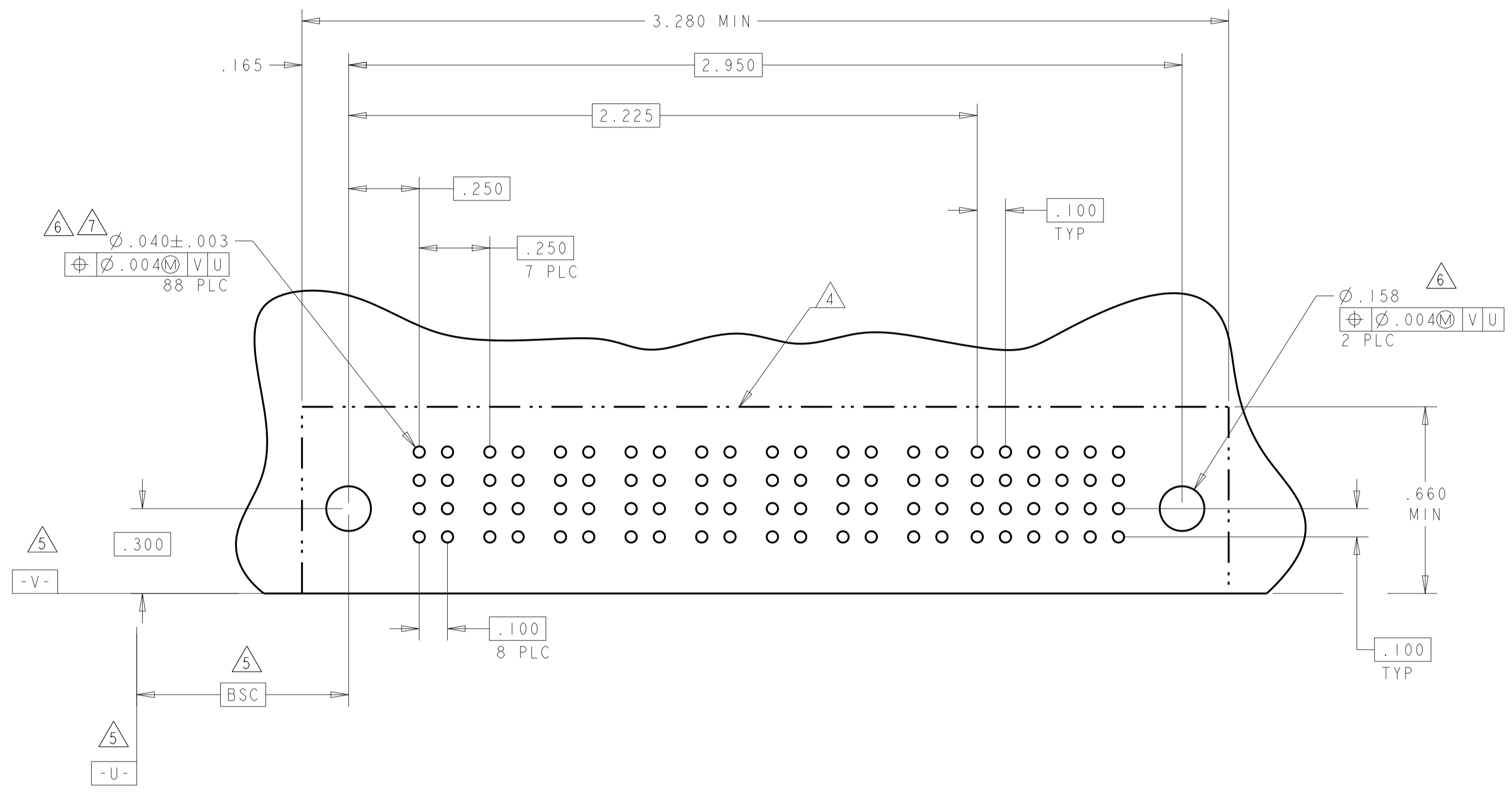

PART NUMBER	ROWS	POWER				SIGNAL					
		P1	P2	P3	P4	1	2	3	4	5	6
2-6450332-5	D C B A	PM	PM	PM	PM	E	E	E	E	E	E
		PM	PM	PM	PM	K	F	F	F	F	F
		PM	PM	PM	PM	N	G	G	G	G	G
4P + 24S						H	H	H	H	H	S

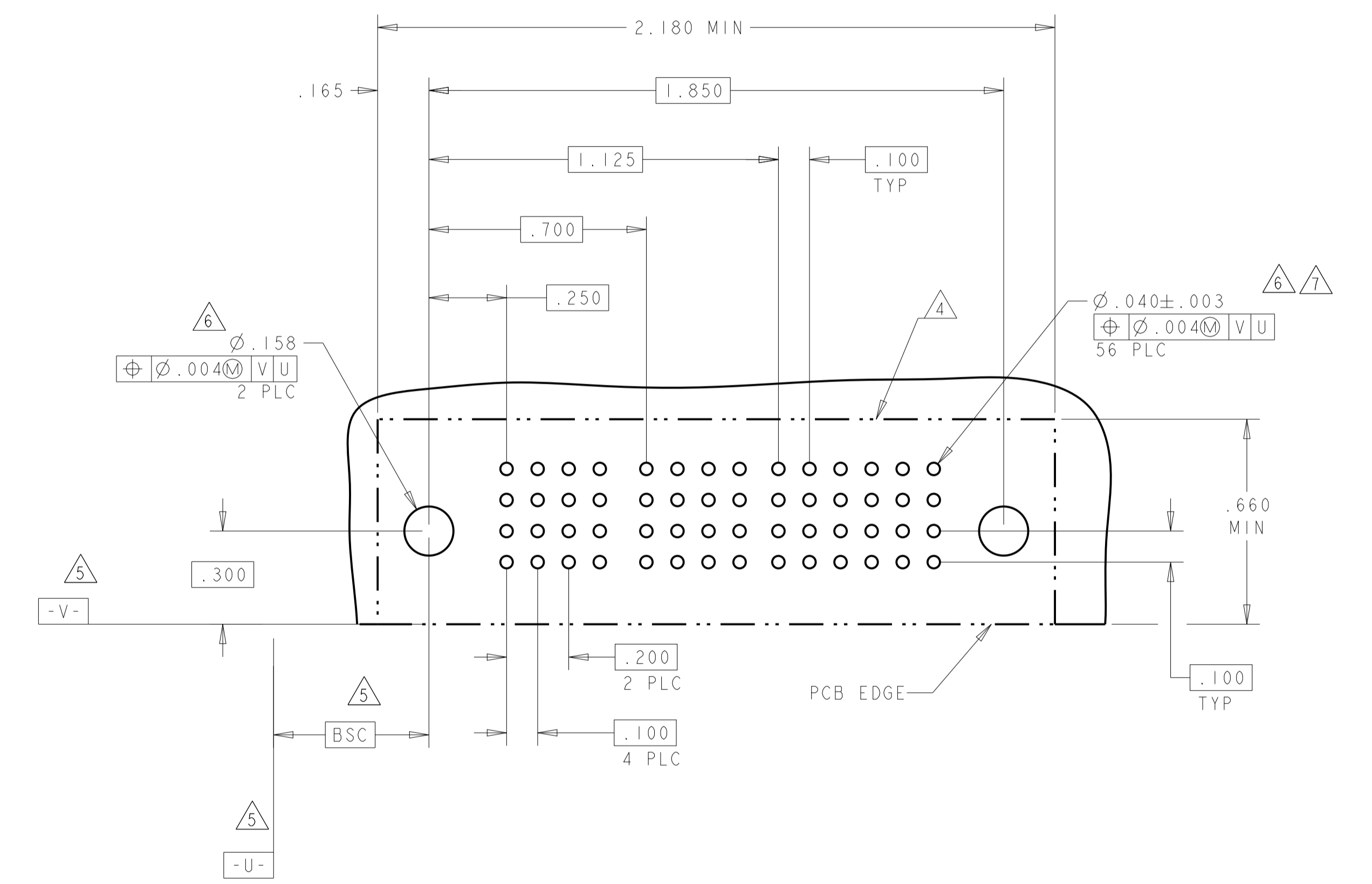

THIS DRAWING IS A CONTROLLED DOCUMENT.

DIMENSIONS: INCHES	TOLERANCES UNLESS OTHERWISE SPECIFIED: 0 PLC ±.01 2 PLC ±.01 3 PLC ±.01 4 PLC ±.005 5 PLC ±.005 ANGLES ±.020	FINISH	APVD: M. PERCHERKE	NAME: M. PERCHERKE	PRODUCT SPEC: 108-1973	APPLICATION SPEC: 114-13038	WEIGHT: -	SCALE: 4:1	SHEET: 9 OF 13	REV: H6
-----------------------	--	--------	--------------------	--------------------	------------------------	-----------------------------	-----------	------------	----------------	---------

STE TE Connectivity

RIGHT ANGLE SOLDER HEADER ASSEMBLY MULTI-BEAM XL

SIZE: A100779 C=6450332

CUSTOMER DRAWING

LOC	DIST	REVISIONS			
P	LTN	DESCRIPTION	DATE	DMN	APVD
ES	00	SEE SHEET 1	-	-	-

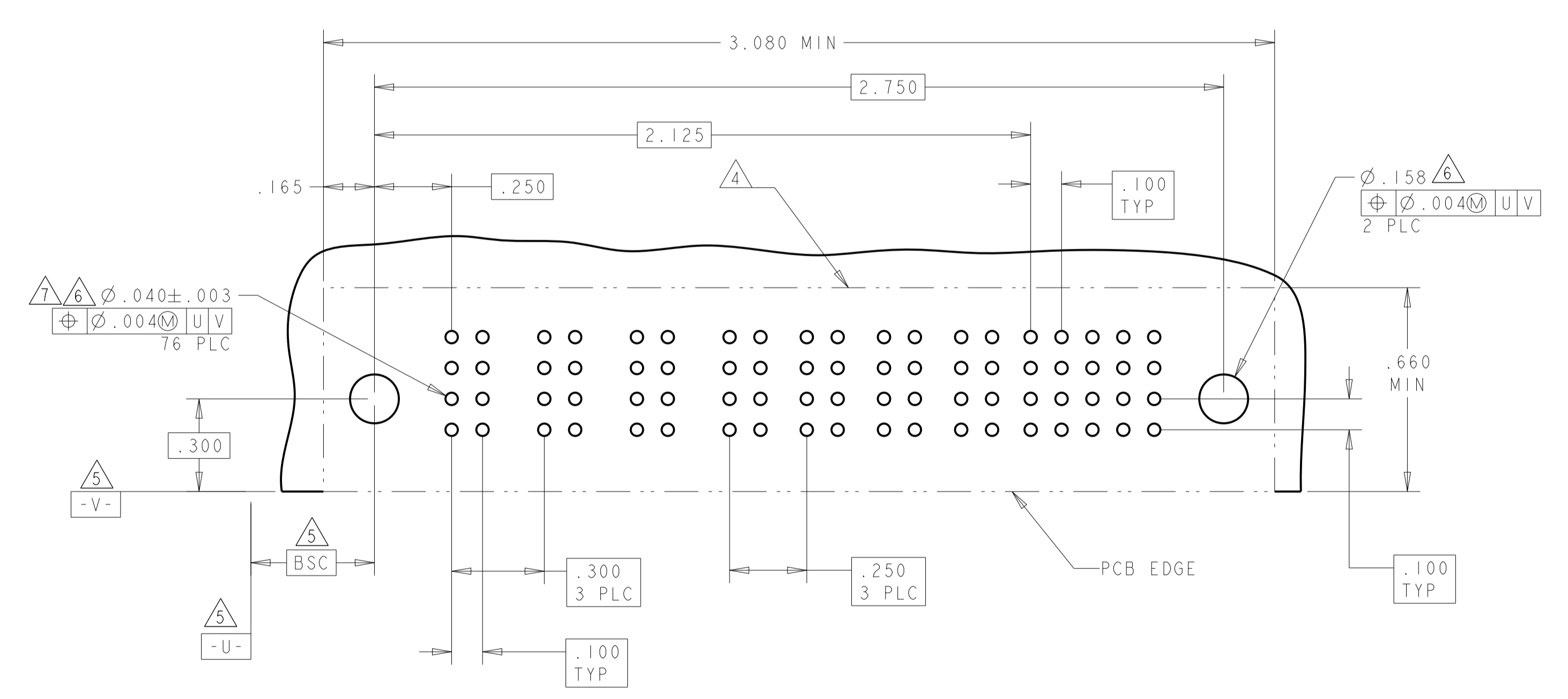
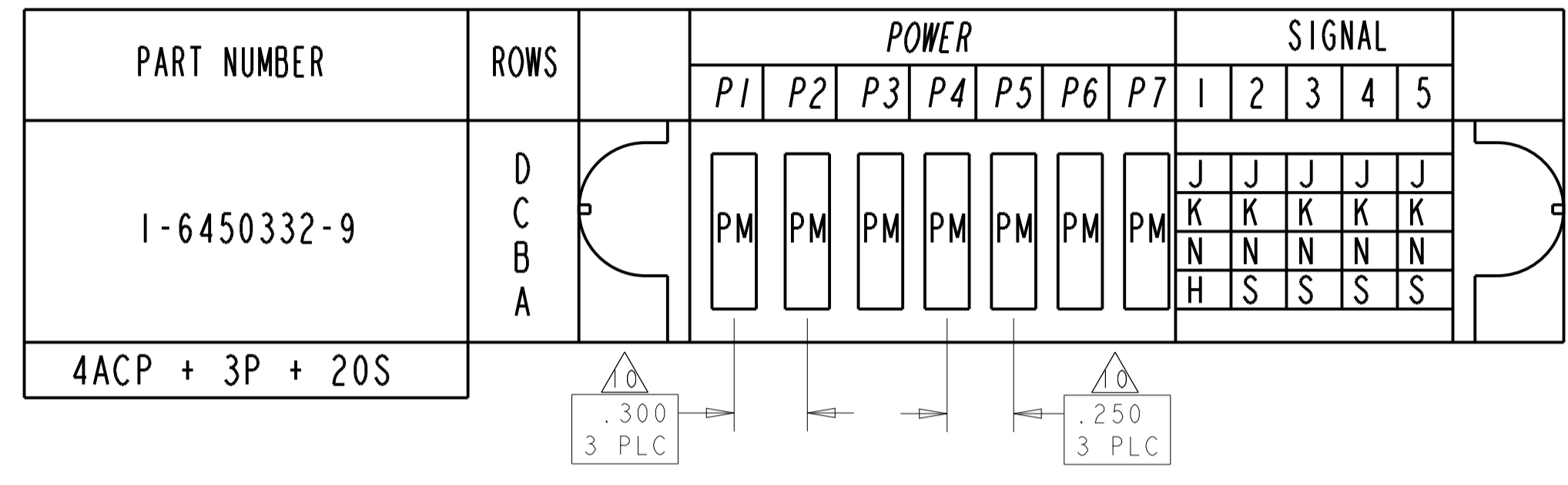

THIS DRAWING IS A CONTROLLED DOCUMENT.		DMN R. GRZYBOWSKI 24JAN05	NAME RIGHT ANGLE SOLDER HEADER ASSEMBLY MULTI-BEAM XL														
DIMENSIONS: INCHES		CHK M. PERCHERKE 24JAN05	RESTRICTED TO														
TOLERANCES UNLESS OTHERWISE SPECIFIED:		APVD M. PERCHERKE	SCALE 4:1 SHEET 11 OF 13 REV H6														
<table border="1"> <tr><td>0 PLC</td><td>±</td></tr> <tr><td>1 PLC</td><td>±.01</td></tr> <tr><td>2 PLC</td><td>±.01</td></tr> <tr><td>3 PLC</td><td>±.01</td></tr> <tr><td>4 PLC</td><td>±.005</td></tr> <tr><td>5 PLC</td><td>±.002</td></tr> <tr><td>ANGLES</td><td>±.020</td></tr> </table>		0 PLC	±	1 PLC	±.01	2 PLC	±.01	3 PLC	±.01	4 PLC	±.005	5 PLC	±.002	ANGLES	±.020	PRODUCT SPEC 108-1973	SIZE A100779
0 PLC	±																
1 PLC	±.01																
2 PLC	±.01																
3 PLC	±.01																
4 PLC	±.005																
5 PLC	±.002																
ANGLES	±.020																
MATERIAL		APPLICATION SPEC 114-13038	CAGE CODE DRAWING NO C=6450332														
FINISH		WEIGHT	CUSTOMER DRAWING														

LOC		DIST		REVISIONS			
ES	00	P	LTM	DESCRIPTION	DATE	OWN	APVD
				SEE SHEET 1			

PART NUMBER	ROWS	POWER							SIGNAL							
		P1	P2	P3	P4	P5	P6	P7	P8	P9	1	2	3	4	5	6
3-6450332-0	D C B A	PM	PM	PM	PM	PM	PM	PM	PM	J	J	J	J	J	J	J
										K	K	K	K	K	K	K
										N	N	N	N	N	N	N
										S	S	S	S	S	S	S

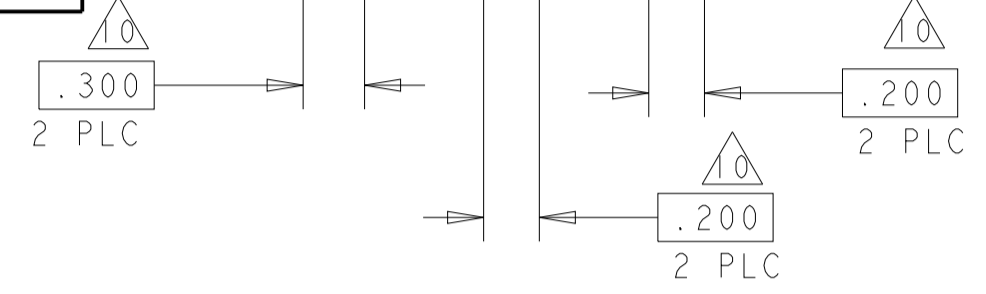

PART NUMBER	ROWS	POWER							SIGNAL						
		P1	P2	P3	P4	P5	P6	P7	1	2	3	4	5	6	
3-6450332-1	D C B A	PM	PM	PM	PM	PM	PM	PM	J	J	J	J	J	J	J
									K	K	K	K	K	K	K
									N	N	N	N	N	N	N
									H	S	S	S	S	S	S

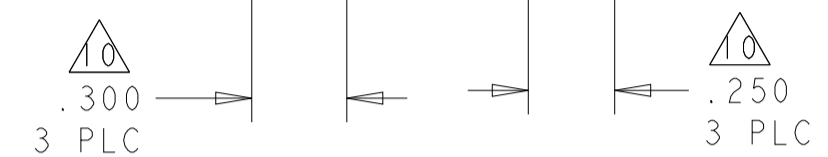

PART NUMBER	ROWS	POWER							SIGNAL						
		P1	P2	P3	P4	P5	P6	P7	1	2	3	4	5	6	
3-6450332-3	D C B A	PM	PM	PM	PM	PM	PM	PM	E	E	J	J	J	J	E
									K	F	F	F	K	F	K
									N	G	G	G	N	G	N
									S	H	S	S	H	H	S

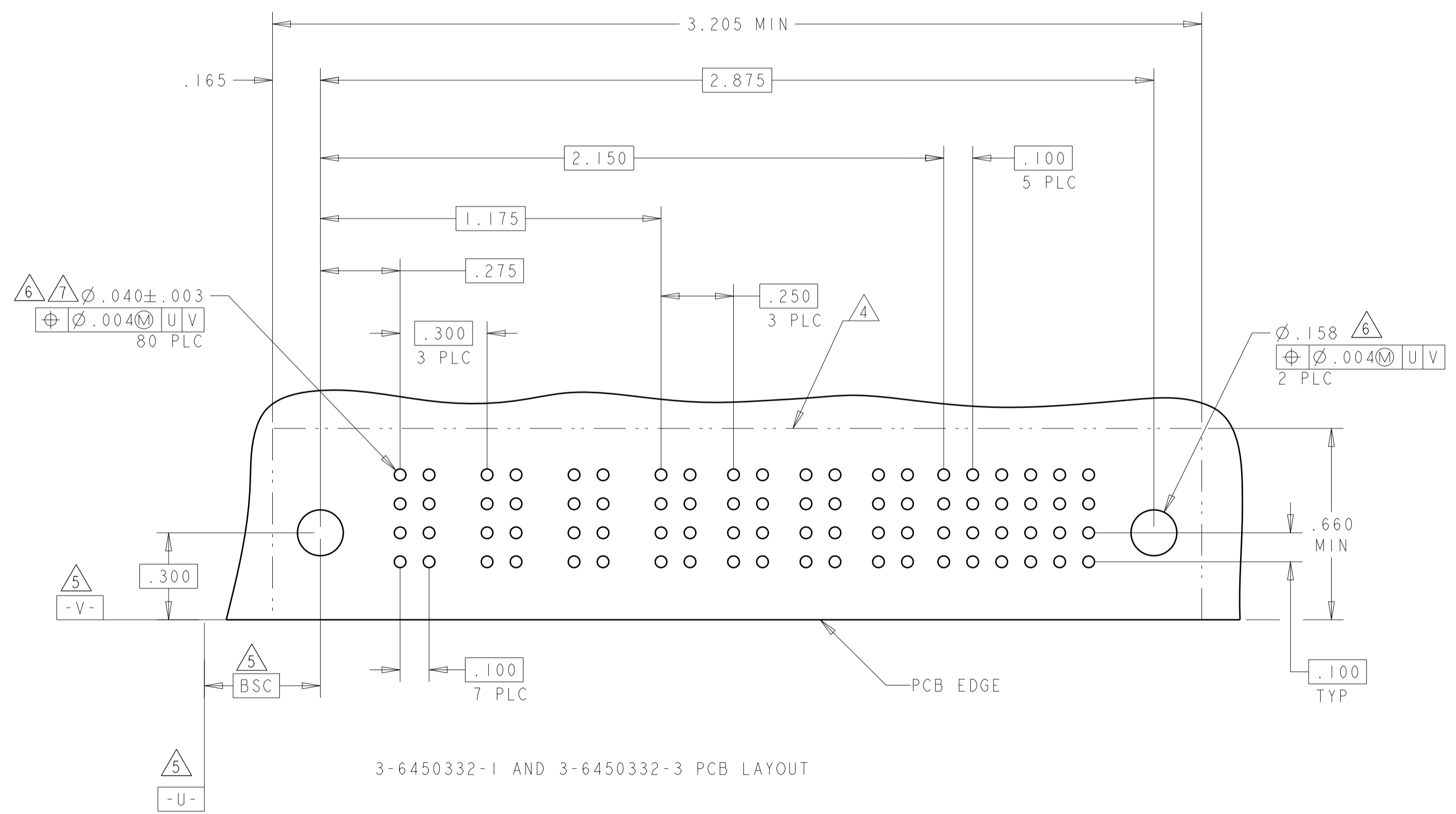
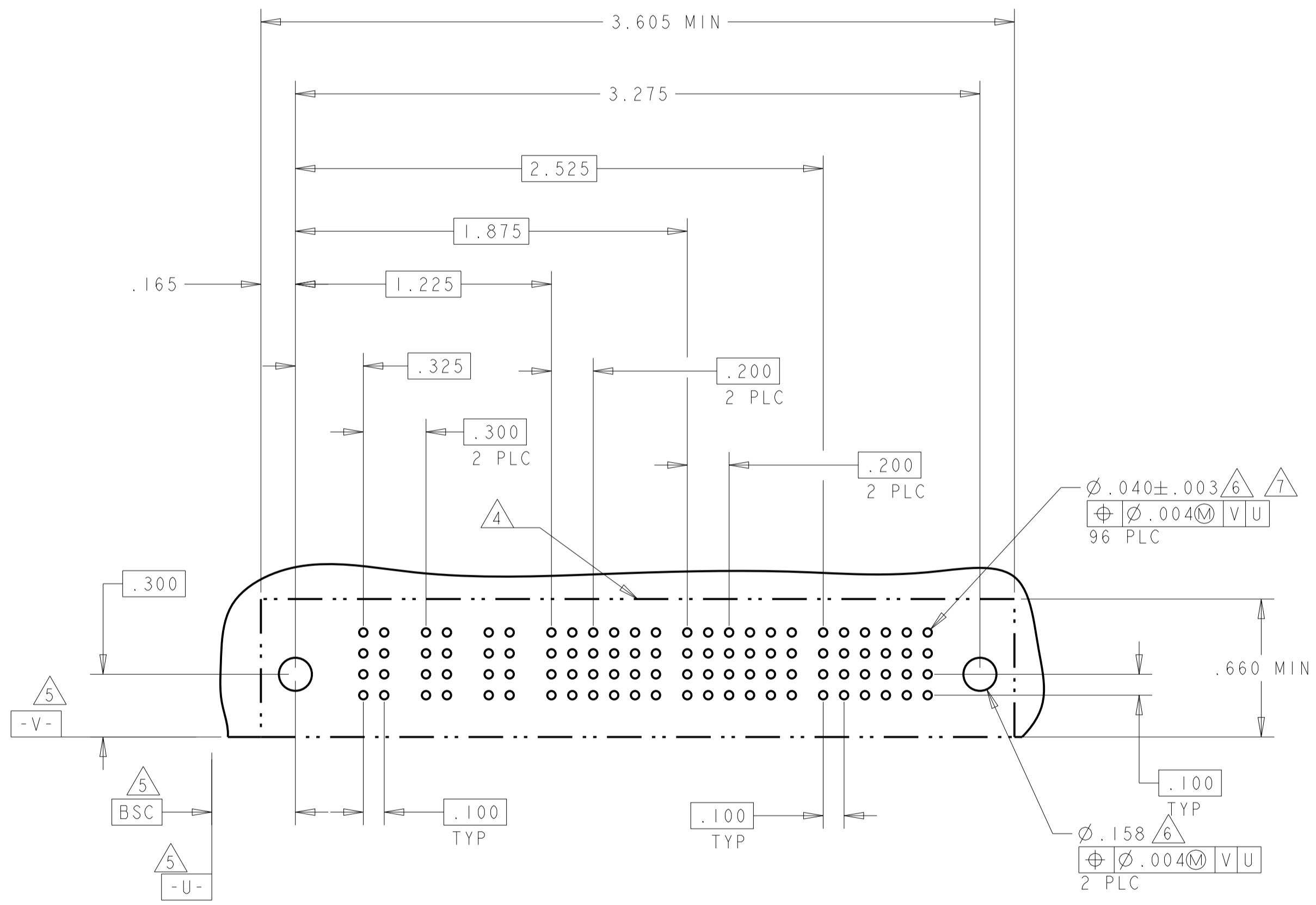
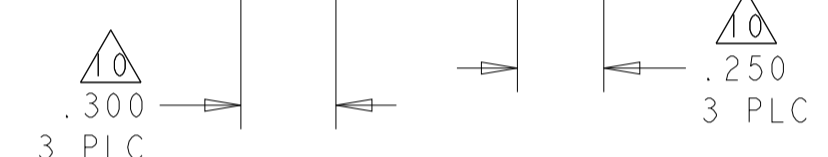

3-6450332-1 AND 3-6450332-3 PCB LAYOUT

THIS DRAWING IS A CONTROLLED DOCUMENT.

OWN: R. GRZYBOWSKI 24JAN05
CHK: M. PERCHERKE 24JAN05
APVD: M. PERCHERKE

TE Connectivity

NAME: RIGHT ANGLE SOLDER HEADER ASSEMBLY MULTI-BEAM XL

PRODUCT SPEC: 108-1973
APPLICATION SPEC: 114-13038

SIZE: A100779 C=6450332
SCALE: 4:1 SHEET 12 OF 13 REV: H6

LOC		DIST		REVISIONS			
ES	00	P	LTN	DESCRIPTION	DATE	DWN	APVD
-	-	-	-	SEE SHEET 1	-	-	-

PART NUMBER	ROWS	POWER				SIGNAL		
		P1	P2	P3	P4	1	2	3
3-6450332-2	D C B A	PM	PM	PM	PM	J K N S	E F N S	J F N S
4P + 12S								

PART NUMBER	ROWS	POWER				SIGNAL					
		P1	P2	P3	P4	1	2	3	4	5	6
3-6450332-4	D C B A	PM	PM	PM	PM	E K N S	E F G H	J F G S	J F G S	J K N S	E F G H
4P + 24S											

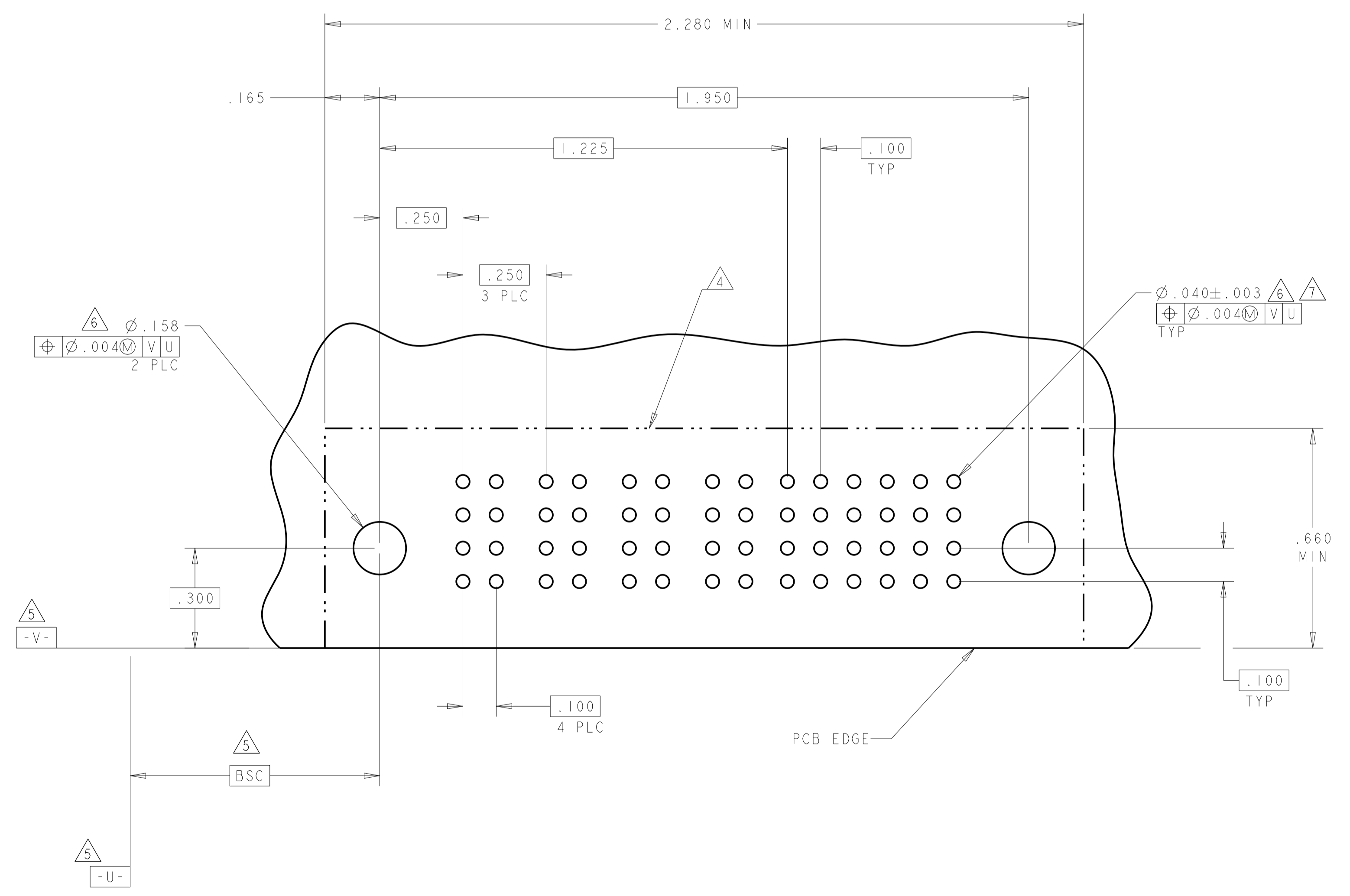
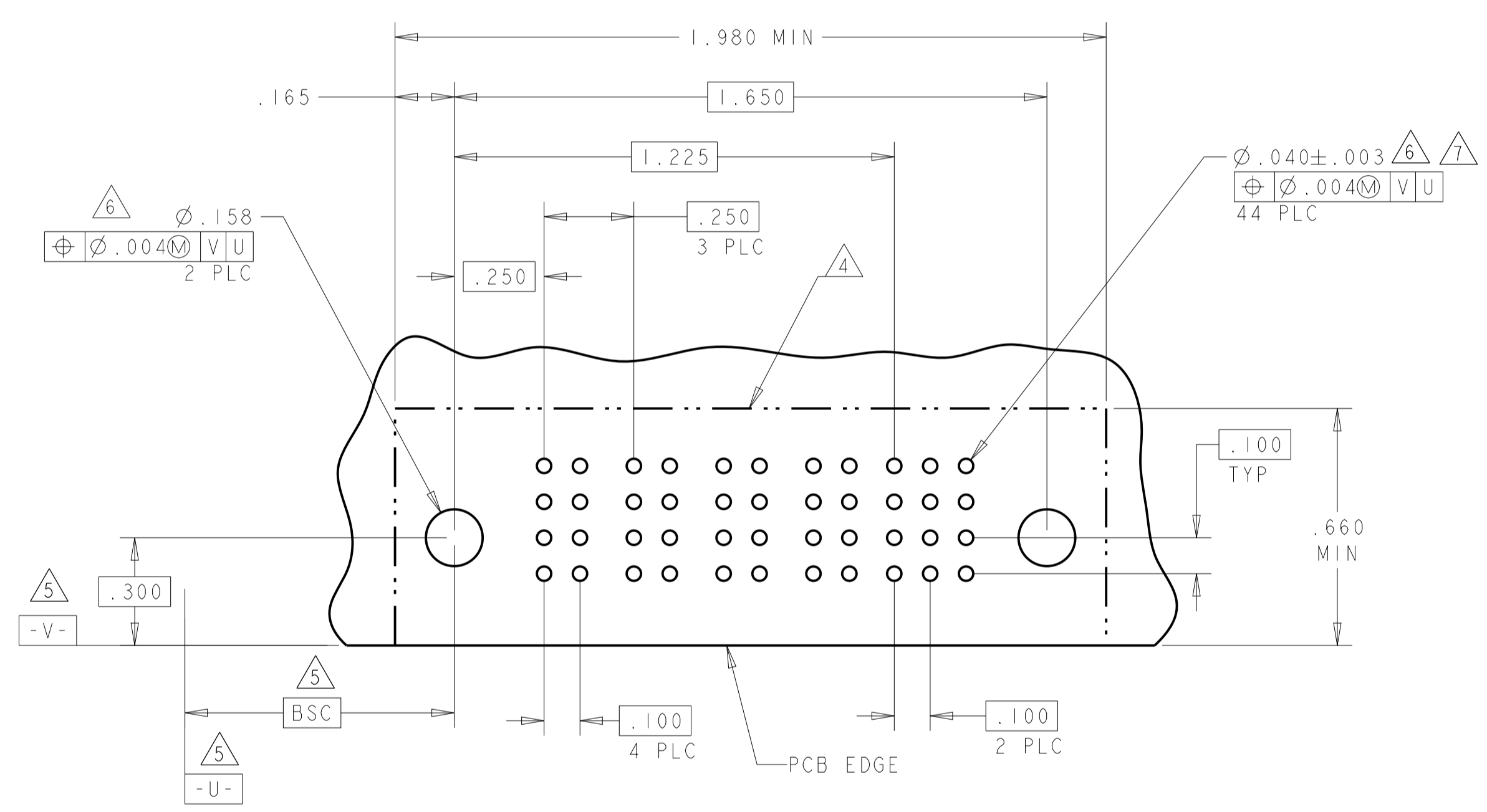

THIS DRAWING IS A CONTROLLED DOCUMENT. DWN: B. GRZYBOWSKI, 24JAN05, CHK: M. PERCHERKE, 24JAN05, APVD: M. PERCHERKE. NAME: RIGHT ANGLE SOLDER HEADER ASSEMBLY MULTI-BEAM XL. DIMENSIONS: INCHES. TOLERANCES UNLESS OTHERWISE SPECIFIED: 0 PLC ±.01, 1 PLC ±.01, 2 PLC ±.01, 3 PLC ±.005, 4 PLC ±.002, ANGLES ±.020. MATERIAL: FINISH: CUSTOMER DRAWING. SCALE: 4:1. SHEET 13 OF 13. REV: H6.



Компания «ЭлектроПласт» предлагает заключение долгосрочных отношений при поставках импортных электронных компонентов на взаимовыгодных условиях!

Наши преимущества:

- Оперативные поставки широкого спектра электронных компонентов отечественного и импортного производства напрямую от производителей и с крупнейших мировых складов;
- Поставка более 17-ти миллионов наименований электронных компонентов;
- Поставка сложных, дефицитных, либо снятых с производства позиций;
- Оперативные сроки поставки под заказ (от 5 рабочих дней);
- Экспресс доставка в любую точку России;
- Техническая поддержка проекта, помощь в подборе аналогов, поставка прототипов;
- Система менеджмента качества сертифицирована по Международному стандарту ISO 9001;
- Лицензия ФСБ на осуществление работ с использованием сведений, составляющих государственную тайну;
- Поставка специализированных компонентов (Xilinx, Altera, Analog Devices, Intersil, Interpoint, Microsemi, Aeroflex, Peregrine, Syfer, Eurofarad, Texas Instrument, Miteq, Cobham, E2V, MA-COM, Hittite, Mini-Circuits, General Dynamics и др.);

Помимо этого, одним из направлений компании «ЭлектроПласт» является направление «Источники питания». Мы предлагаем Вам помощь Конструкторского отдела:

- Подбор оптимального решения, техническое обоснование при выборе компонента;
- Подбор аналогов;
- Консультации по применению компонента;
- Поставка образцов и прототипов;
- Техническая поддержка проекта;
- Защита от снятия компонента с производства.



Как с нами связаться

Телефон: 8 (812) 309 58 32 (многоканальный)

Факс: 8 (812) 320-02-42

Электронная почта: org@eplast1.ru

Адрес: 198099, г. Санкт-Петербург, ул. Калинина, дом 2, корпус 4, литера А.