



MICROCHIP

**EVB-USB5744
Evaluation Board
User's Guide**

Note the following details of the code protection feature on Microchip devices:

- Microchip products meet the specification contained in their particular Microchip Data Sheet.
- Microchip believes that its family of products is one of the most secure families of its kind on the market today, when used in the intended manner and under normal conditions.
- There are dishonest and possibly illegal methods used to breach the code protection feature. All of these methods, to our knowledge, require using the Microchip products in a manner outside the operating specifications contained in Microchip's Data Sheets. Most likely, the person doing so is engaged in theft of intellectual property.
- Microchip is willing to work with the customer who is concerned about the integrity of their code.
- Neither Microchip nor any other semiconductor manufacturer can guarantee the security of their code. Code protection does not mean that we are guaranteeing the product as “unbreakable.”

Code protection is constantly evolving. We at Microchip are committed to continuously improving the code protection features of our products. Attempts to break Microchip's code protection feature may be a violation of the Digital Millennium Copyright Act. If such acts allow unauthorized access to your software or other copyrighted work, you may have a right to sue for relief under that Act.

Information contained in this publication regarding device applications and the like is provided only for your convenience and may be superseded by updates. It is your responsibility to ensure that your application meets with your specifications. MICROCHIP MAKES NO REPRESENTATIONS OR WARRANTIES OF ANY KIND WHETHER EXPRESS OR IMPLIED, WRITTEN OR ORAL, STATUTORY OR OTHERWISE, RELATED TO THE INFORMATION, INCLUDING BUT NOT LIMITED TO ITS CONDITION, QUALITY, PERFORMANCE, MERCHANTABILITY OR FITNESS FOR PURPOSE. Microchip disclaims all liability arising from this information and its use. Use of Microchip devices in life support and/or safety applications is entirely at the buyer's risk, and the buyer agrees to defend, indemnify and hold harmless Microchip from any and all damages, claims, suits, or expenses resulting from such use. No licenses are conveyed, implicitly or otherwise, under any Microchip intellectual property rights unless otherwise stated.

Trademarks

The Microchip name and logo, the Microchip logo, dsPIC, FlashFlex, flexPWR, JukeBlox, KEELOQ, KEELOQ logo, Kleer, LANCheck, MediaLB, MOST, MOST logo, MPLAB, OptoLyzer, PIC, PICSTART, PIC³² logo, RightTouch, SpyNIC, SST, SST Logo, SuperFlash and UNI/O are registered trademarks of Microchip Technology Incorporated in the U.S.A. and other countries.

The Embedded Control Solutions Company and mTouch are registered trademarks of Microchip Technology Incorporated in the U.S.A.

Analog-for-the-Digital Age, BodyCom, chipKIT, chipKIT logo, CodeGuard, dsPICDEM, dsPICDEM.net, ECAN, In-Circuit Serial Programming, ICSP, Inter-Chip Connectivity, KleerNet, KleerNet logo, MiWi, MPASM, MPF, MPLAB Certified logo, MPLIB, MPLINK, MultiTRAK, NetDetach, Omniscient Code Generation, PICDEM, PICDEM.net, PICKit, PICTail, RightTouch logo, REAL ICE, SQI, Serial Quad I/O, Total Endurance, TSHARC, USBCheck, VariSense, ViewSpan, WiperLock, Wireless DNA, and ZENA are trademarks of Microchip Technology Incorporated in the U.S.A. and other countries.

SQTP is a service mark of Microchip Technology Incorporated in the U.S.A.

Silicon Storage Technology is a registered trademark of Microchip Technology Inc. in other countries.

GestIC is a registered trademarks of Microchip Technology Germany II GmbH & Co. KG, a subsidiary of Microchip Technology Inc., in other countries.

All other trademarks mentioned herein are property of their respective companies.

© 2015, Microchip Technology Incorporated, Printed in the U.S.A., All Rights Reserved.

ISBN: 9781632776631

**QUALITY MANAGEMENT SYSTEM
CERTIFIED BY DNV
= ISO/TS 16949 =**

Microchip received ISO/TS-16949:2009 certification for its worldwide headquarters, design and wafer fabrication facilities in Chandler and Tempe, Arizona; Gresham, Oregon and design centers in California and India. The Company's quality system processes and procedures are for its PIC[®] MCUs and dsPIC[®] DSCs, KEELOQ[®] code hopping devices, Serial EEPROMs, microperipherals, nonvolatile memory and analog products. In addition, Microchip's quality system for the design and manufacture of development systems is ISO 9001:2000 certified.

Object of Declaration: EVB-USB5744 Evaluation Board

EU Declaration of Conformity

Manufacturer: Microchip Technology Inc.
2355 W. Chandler Blvd.
Chandler, Arizona, 85224-6199
USA

This declaration of conformity is issued by the manufacturer.

The development/evaluation tool is designed to be used for research and development in a laboratory environment. This development/evaluation tool is not a Finished Appliance, nor is it intended for incorporation into Finished Appliances that are made commercially available as single functional units to end users under EU EMC Directive 2004/108/EC and as supported by the European Commission's Guide for the EMC Directive 2004/108/EC (8th February 2010).

This development/evaluation tool complies with EU RoHS2 Directive 2011/65/EU.

This development/evaluation tool, when incorporating wireless and radio-telecom functionality, is in compliance with the essential requirement and other relevant provisions of the R&TTE Directive 1999/5/EC and the FCC rules as stated in the declaration of conformity provided in the module datasheet and the module product page available at www.microchip.com.

For information regarding the exclusive, limited warranties applicable to Microchip products, please see Microchip's standard terms and conditions of sale, which are printed on our sales documentation and available at www.microchip.com.

Signed for and on behalf of Microchip Technology Inc. at Chandler, Arizona, USA

Derek Carlson
VP Development Tools

12-Sep-14
Date

NOTES:

Table of Contents

Preface	6
Introduction.....	6
Document Layout	6
Conventions Used in this Guide	7
The Microchip Web Site	8
Development Systems Customer Change Notification Service	8
Customer Support	8
Document Revision History	9
Chapter 1. Overview	
1.1 Introduction	10
Chapter 2. Getting Started	
2.1 Configuration	11
2.1.1 External SPI Flash	11
2.1.2 SMBus	12
2.1.3 Configuration Source - Internal Default	12
2.1.4 Strapping Option	12
2.1.5 Port Power Options: Port Enable and Port Disable Select	13
2.2 Power Source - Self-Powered	14
2.3 Downstream Port Power Control	14
Appendix A. EVB-USB5744 Evaluation Board	
A.1 Introduction	15
Appendix B. EVB-USB5744 Evaluation Board Schematics	
B.1 Introduction	16
Appendix C. Bill of Materials (BOM)	
C.1 Introduction	19
Appendix D. EVB-USB5744 Silk Screens	
D.1 Introduction	22
Worldwide Sales and Service	24

Preface

NOTICE TO CUSTOMERS

All documentation becomes dated, and this manual is no exception. Microchip tools and documentation are constantly evolving to meet customer needs, so some actual dialogs and/or tool descriptions may differ from those in this document. Please refer to our web site (www.microchip.com) to obtain the latest documentation available.

Documents are identified with a “DS” number. This number is located on the bottom of each page, in front of the page number. The numbering convention for the DS number is “DSXXXXA”, where “XXXX” is the document number and “A” is the revision level of the document.

For the most up-to-date information on development tools, see the MPLAB® IDE online help. Select the Help menu, and then Topics to open a list of available online help files.

INTRODUCTION

This chapter contains general information that will be useful to know before using the EVB-USB5744 Evaluation Board. Items discussed in this chapter include:

- [Document Layout](#)
- [Conventions Used in this Guide](#)
- [The Microchip Web Site](#)
- [Development Systems Customer Change Notification Service](#)
- [Customer Support](#)
- [Document Revision History](#)

DOCUMENT LAYOUT

This document describes how to use the EVB-USB5744 Evaluation Board as a development tool for the USB5744 4 port USB 3.1 Gen 1 hub with battery charging features.

- **Chapter 1. “Overview”** – Shows a brief description of the EVB-USB5744 Evaluation Board.
- **Chapter 2. “Getting Started”** – Includes instructions on how to get started with the EVB-USB5744 Evaluation Board.
- **Appendix A. “EVB-USB5744 Evaluation Board”** – This appendix shows the EVB-USB5744 Evaluation Board.
- **Appendix B. “EVB-USB5744 Evaluation Board Schematics”** – This appendix shows the EVB-USB5744 Evaluation Board schematics.
- **Appendix C. “Bill of Materials (BOM)”** – This appendix includes the EVB-USB5744 Evaluation Board Bill of Materials (BOM).
- **Appendix D. “EVB-USB5744 Silk Screens”** – This appendix includes the EVB-USB5744 Evaluation Board silk screens.

CONVENTIONS USED IN THIS GUIDE

This manual uses the following documentation conventions:

DOCUMENTATION CONVENTIONS

Description	Represents	Examples
Arial font:		
Italic characters	Referenced books	<i>MPLAB[®] IDE User's Guide</i>
	Emphasized text	...is the <i>only</i> compiler...
Initial caps	A window	the Output window
	A dialog	the Settings dialog
	A menu selection	select Enable Programmer
Quotes	A field name in a window or dialog	"Save project before build"
Underlined, italic text with right angle bracket	A menu path	<u><i>File>Save</i></u>
Bold characters	A dialog button	Click OK
	A tab	Click the Power tab
N'Rnnnn	A number in verilog format, where N is the total number of digits, R is the radix and n is a digit.	4'b0010, 2'hF1
Text in angle brackets < >	A key on the keyboard	Press <Enter>, <F1>
Courier New font:		
Plain Courier New	Sample source code	#define START
	Filenames	autoexec.bat
	File paths	c:\mcc18\h
	Keywords	_asm, _endasm, static
	Command-line options	-Opa+, -Opa-
	Bit values	0, 1
	Constants	0xFF, 'A'
Italic Courier New	A variable argument	<i>file.o</i> , where <i>file</i> can be any valid filename
Square brackets []	Optional arguments	mcc18 [options] <i>file</i> [options]
Curly brackets and pipe character: { }	Choice of mutually exclusive arguments; an OR selection	errorlevel {0 1}
Ellipses...	Replaces repeated text	var_name [, var_name...]
	Represents code supplied by user	void main (void) { ... }

THE MICROCHIP WEB SITE

Microchip provides online support via our web site at www.microchip.com. This web site is used as a means to make files and information easily available to customers. Accessible by using your favorite Internet browser, the web site contains the following information:

- **Product Support** – Data sheets and errata, application notes and sample programs, design resources, user's guides and hardware support documents, latest software releases and archived software
- **General Technical Support** – Frequently Asked Questions (FAQs), technical support requests, online discussion groups, Microchip consultant program member listing
- **Business of Microchip** – Product selector and ordering guides, latest Microchip press releases, listing of seminars and events, listings of Microchip sales offices, distributors and factory representatives

DEVELOPMENT SYSTEMS CUSTOMER CHANGE NOTIFICATION SERVICE

Microchip's customer notification service helps keep customers current on Microchip products. Subscribers will receive e-mail notification whenever there are changes, updates, revisions or errata related to a specified product family or development tool of interest.

To register, access the Microchip web site at www.microchip.com, click on Customer Change Notification and follow the registration instructions.

The Development Systems product group categories are:

- **Compilers** – The latest information on Microchip C compilers, assemblers, linkers and other language tools. These include all MPLAB C compilers; all MPLAB assemblers (including MPASM assembler); all MPLAB linkers (including MPLINK object linker); and all MPLAB librarians (including MPLIB object librarian).
- **Emulators** – The latest information on Microchip in-circuit emulators. This includes the MPLAB REAL ICE and MPLAB ICE 2000 in-circuit emulators.
- **In-Circuit Debuggers** – The latest information on the Microchip in-circuit debuggers. This includes MPLAB ICD 3 in-circuit debuggers and PICkit 3 debug express.
- **MPLAB IDE** – The latest information on Microchip MPLAB IDE, the Windows Integrated Development Environment for development systems tools. This list is focused on the MPLAB IDE, MPLAB IDE Project Manager, MPLAB Editor and MPLAB SIM simulator, as well as general editing and debugging features.
- **Programmers** – The latest information on Microchip programmers. These include production programmers such as MPLAB REAL ICE in-circuit emulator, MPLAB ICD 3 in-circuit debugger and MPLAB PM3 device programmers. Also included are nonproduction development programmers such as PICSTART Plus and PIC-kit 2 and 3.

CUSTOMER SUPPORT

Users of Microchip products can receive assistance through several channels:

- Distributor or Representative
- Local Sales Office
- Field Application Engineer (FAE)
- Technical Support

Customers should contact their distributor, representative or field application engineer (FAE) for support. Local sales offices are also available to help customers. A listing of sales offices and locations is included in the back of this document.

Technical support is available through the web site at:

<http://www.microchip.com/support>

DOCUMENT REVISION HISTORY

Revision	Section/Figure/Entry	Correction
DS50002306B (08-06-15)	Updated "USB 3.0" references to "USB 3.1 Gen 1" throughout document	
REV A - December 2014		Initial release of document

Chapter 1. Overview

1.1 INTRODUCTION

The EVB-USB5744 Revision A is a demonstration and evaluation platform that provides the necessary requirements and interface options for evaluating the USB5744 Ultra Fast four port battery charging hub on a 4-layer RoHS-compliant Printed Circuit Board (PCB). This will allow the user to gain an understanding of the product and accelerate the integration of the EVB-USB5744 into the user's design. The EVB-USB5744 is compliant with the USB 3.1 Specification and supports SuperSpeed (SS), High-Speed (HS), Full-Speed (FS), and Low-Speed (LS) USB signaling for complete coverage of all defined USB operation speeds. The evaluation platform supports four downstream ports that are USB 2.0 and USB 3.1 Gen 1 compliant. The EVB-USB5744 platform also supports battery charging on all four downstream ports (maximum of 5A at any one time). The EVB-USB5744 is configured for operation through internal default settings and supports custom configurations through SMBus or through the external 64-Mbit SPI Flash device, U8. The EVB-USB5744 demonstrates driver compatibility with Microsoft® Windows® 8x, Windows 7, Windows XP, Mac OS® X 10.4+, and Linux® hub drivers.

The EVB-USB5744 provides the following features:

- USB5744 in a 56-pin QFN RoHS compliant package
- USB 3.1 Gen 1 compliant (SS, HS, FS, and LS operation)
- USB pins are 5 V tolerant
- Self powered operation
- Four downstream USB 2.0/ USB 3.1 Gen 1 ports
- All downstream ports support individual port power and overcurrent sense
- All downstream ports are battery charge enabled (2.1A max per port)
- Can support up to 5A down stream Port Power at any one time
- Onboard SPI Flash for external downloadable firmware
- Low-cost 4-layer space saving design
- Operates from a single voltage (+12.0 V, regulated) external power supply
- Onboard 25 MHz crystal or external clock input
- Single onboard +5.25 V, 6 Amp regulator
- Single onboard +3.3 V, 0.5 Amp regulator
- Single onboard +1.2 V, 1 Amp regulator
- Port Power and Port Enable LED indicators
- LED indicators for SPI/Strap Configuration

Chapter 2. Getting Started

The Microchip EVB-USB5744 is designed for flexible configuration solutions. It can be configured via default internal register settings, downloadable external firmware to an onboard SPI Flash, through SMBus, or through the onboard configuration switches. When configured with the default internal register settings, the device operates as a USB 3.1 Gen 1 / USB 2.0 hub with four battery charge enabled USB ports and Microchip's standard VID/PID/DID settings.

2.1 CONFIGURATION

2.1.1 External SPI Flash

Upon power-up, the USB5744 first looks for an external SPI Flash device and a valid signature in the flash. If one is found, the external ROM is enabled and code execution is initiated from the external SPI device.

To select the SPI device, set the Config. Select switch to "SPI", position 1-2. The blue LED will light. Note that the CFG_BC and CFG_Non-Rem options are now de-selected. All configuration in SPI mode is done by the SPI.

Note: If the SPI Flash is not properly programmed or has an invalid signature, the USB5744 will default to internal defaults even if the SPI Flash is selected.

FIGURE 2-1: SPI SELECT

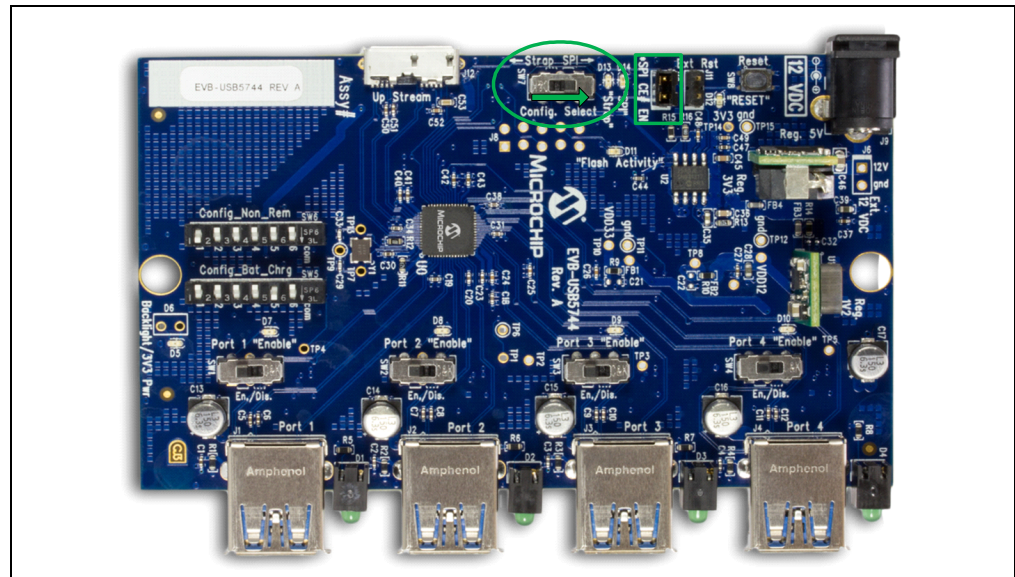

The 10 k Ω pull-up resistors (R42 and R58) on the SPI device's Write Protect (WPn) and Hold (HOLDn) pins must also be populated in order to use external flash. The 10 k Ω pull-up resistor (R61) on the SPI_CE_N pin of the USB5744 must also be populated in order to select 60MHz SPI operation, as opposed to 30MHz operation. Additionally there must be a jumper placed on

J10 in order to enable the SPI device. The external flash can be programmed using the Microchip ProTouch MPT software tool which can be downloaded from the Microchip website at <http://www.Microchip.com/ProTouch>.

Note: Refer to the Protouch MPT User Manual on using this software to program the configuration.

2.1.2 SMBus

If an SPI Flash device is not found, the firmware checks if the SMBus is enabled. The SMBus can operate in either legacy mode (USB 2.0 only) or advanced mode (access to both USB 2.0 and USB 3.1 Gen 1 registers). When using SMBus, the default configuration is for it to run in the advanced mode.

To select SMBus configuration, set the Config. Select switch to "Strap", position 2-3. The green LED will light.

The SMBus must have correct pull up resistors applied by external circuitry to function properly. The SMBus signals may be accessed at J8, pins 1 and 3.

Remember, if configured for SMBus operation the USB5744 will wait indefinitely for data from the SMBus.

FIGURE 2-2: SMBUS SELECT

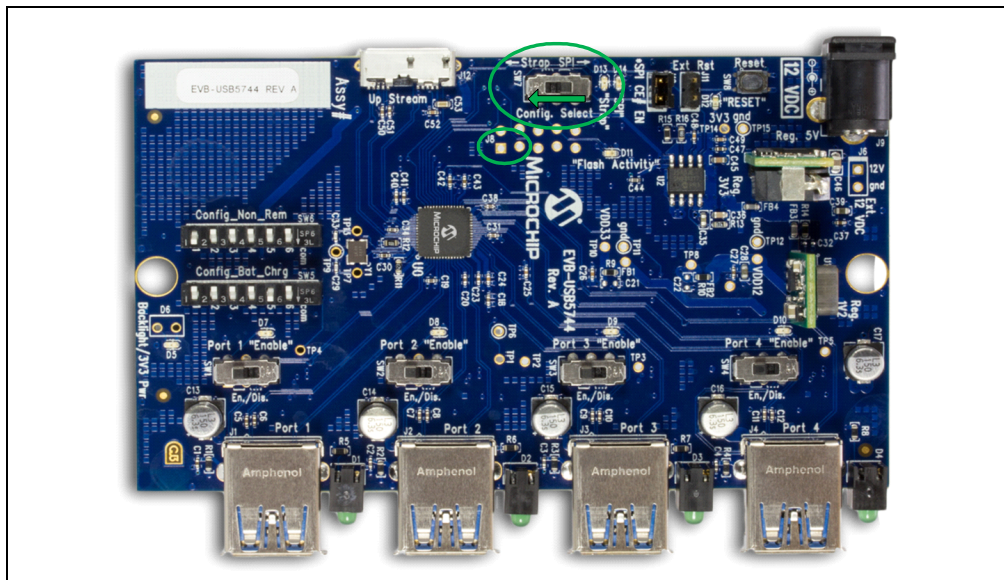

2.1.3 Configuration Source - Internal Default

When the USB5744 does not detect a valid SPI Flash image or SMBus configuration upon power-up, the EVB-USB5744 uses internal default register settings. It also sets the Vendor ID, Product ID, Language ID, and Device ID, and additional settings from internal ROM code.

2.1.4 Strapping Option

If configuration is not done through SPI, additional configuration is available through two functions: CFG_BC and CFG_Non-Rem. The controls are configured by selecting one of six resistor values for each pin. These are read by the USB5744 device and the BC and Non-Rem behavior of the downstream facing ports are determined.

To use the strapping option, set the Config. Select switch to "Strap", position 2-3. The green LED will light. Select the desired CFG_BC and CFG_Non-Rem options by enabling only one position for each of the Config_Bat_Chrg Select and Config_Non_Rem Select switches (SW5 and SW6).

FIGURE 2-3: STRAPPING OPTIONS

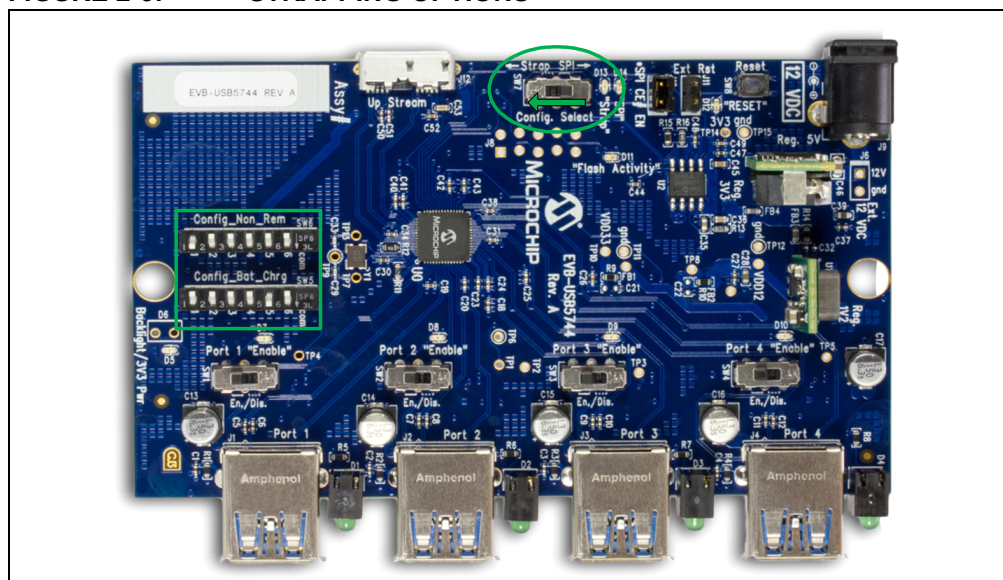

TABLE 2-1: STRAPPING OPTIONS FOR BATTERY CHARGING

SW5 Position	Configuration
1	No BC Enabled
2	Port 1 is BC Enabled
3	Port 1 & 2 are BC Enabled
4	Port 1, 2 & 3 are BC Enabled
5	Port 1, 2, 3 & 4 are BC Enabled [default]
6	Reserved

TABLE 2-2: STRAPPING OPTIONS FOR PORT REMOVABLE

SW6 Position	Configuration
1	All ports are Removable [default]
2	Port 1 is Non-Removable
3	Port 1 & 2 are Non-Removable
4	Port 1, 2 & 3 are Non-Removable
5	Port 1, 2, 3 & 4 are Non-Removable
6	Reserved

2.1.5 Port Power Options: Port Enable and Port Disable Select

Any downstream facing port on the EVB-USB5744 can be disabled if desired. When both **DP** & **DM** signals are pulled up to +3.3V, by default the USB5744 automatically disables the port, reports the corrected number of available ports to the host, and drives the PRT_CTRL line for the disabled port(s) low.

To enable a port, use its Port Enable switch to select the "EN." position. The associated "Enabled" LED will light.

To disable a port, slide its Port Enable switch to the "Dis." position. The "Enabled" LED will extinguish.

The table below describes the port enable/disable strap options available for all four ports on the USB5744.

TABLE 2-3: PORT ENABLE/DISABLE STRAP OPTIONS

Downstream Port	Associated Switch	Switch Position	LED
1	SW1	1-2, 4-5 = Port Enabled (Default)	
		2-3, 5-6 = Port Disabled	
2	SW2	1-2, 4-5 = Port Enabled (Default)	
		2-3, 5-6 = Port Disabled	
3	SW3	1-2, 4-5 = Port Enabled (Default)	
		2-3, 5-6 = Port Disabled	
4	SW4	1-2, 4-5 = Port Enabled (Default)	
		2-3, 5-6 = Port Disabled	

2.2 POWER SOURCE - SELF-POWERED

The EVB-USB5744 only supports self-powered operation, and is powered through one +12.0 V regulated 'wall wart' external power supply. The power supply plugs into the 2.5 mm connector J9 on the board. Alternatively, an external voltage can be injected onto the J6 Ext. 12 V header, which is not populated by default. The +12.0 V feeds a 6 A regulator which outputs +5.25 V across the board. This +5.25 V output supplies the +3.3 V and +1.2 V onboard regulators.

2.3 DOWNSTREAM PORT POWER CONTROL

USB power to the four downstream ports are controlled via port power controllers with auto-discharge function. This provides up to 2.1 A of USB battery charging power to each port, limited to a total of 5 A at any one time.

FIGURE 2-4: INITIAL CONFIGURATION

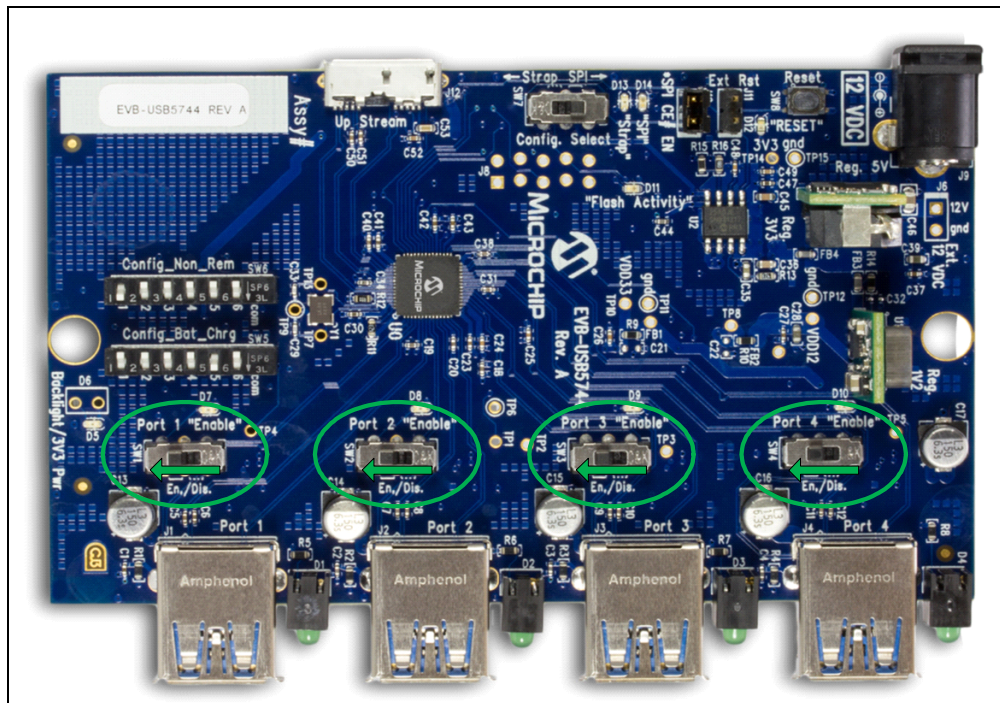

Appendix A. EVB-USB5744 Evaluation Board

A.1 INTRODUCTION

This appendix shows the EVB-USB5744 Evaluation Board.

FIGURE A-1: EVB-USB5744 EVALUATION BOARD

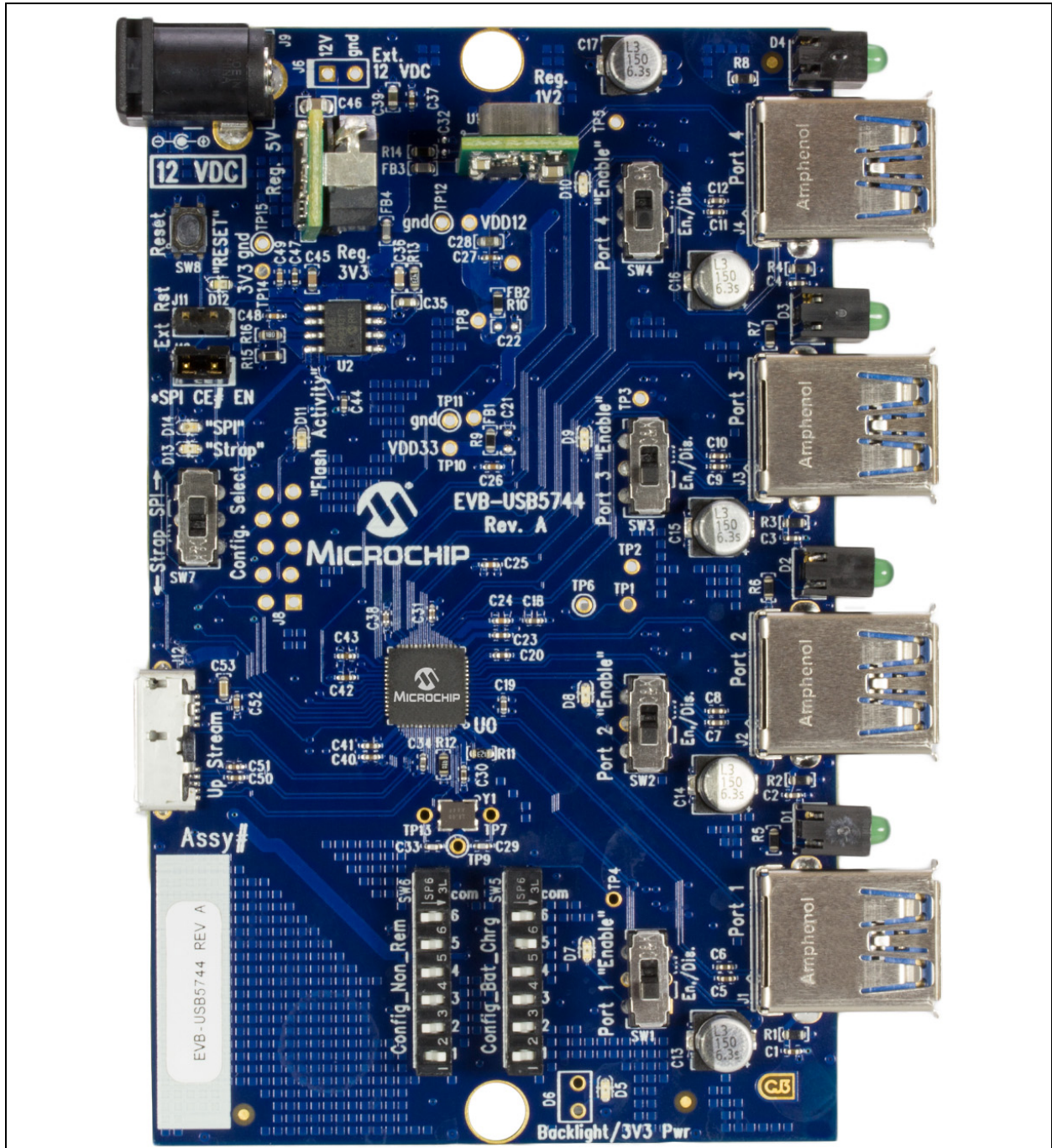



Appendix B. EVB-USB5744 Evaluation Board Schematics

B.1 INTRODUCTION

This appendix shows the EVB-USB5744 Evaluation Board Schematics.

FIGURE B-1: EVB-USB5744 EVALUATION BOARD SCHEMATIC 1

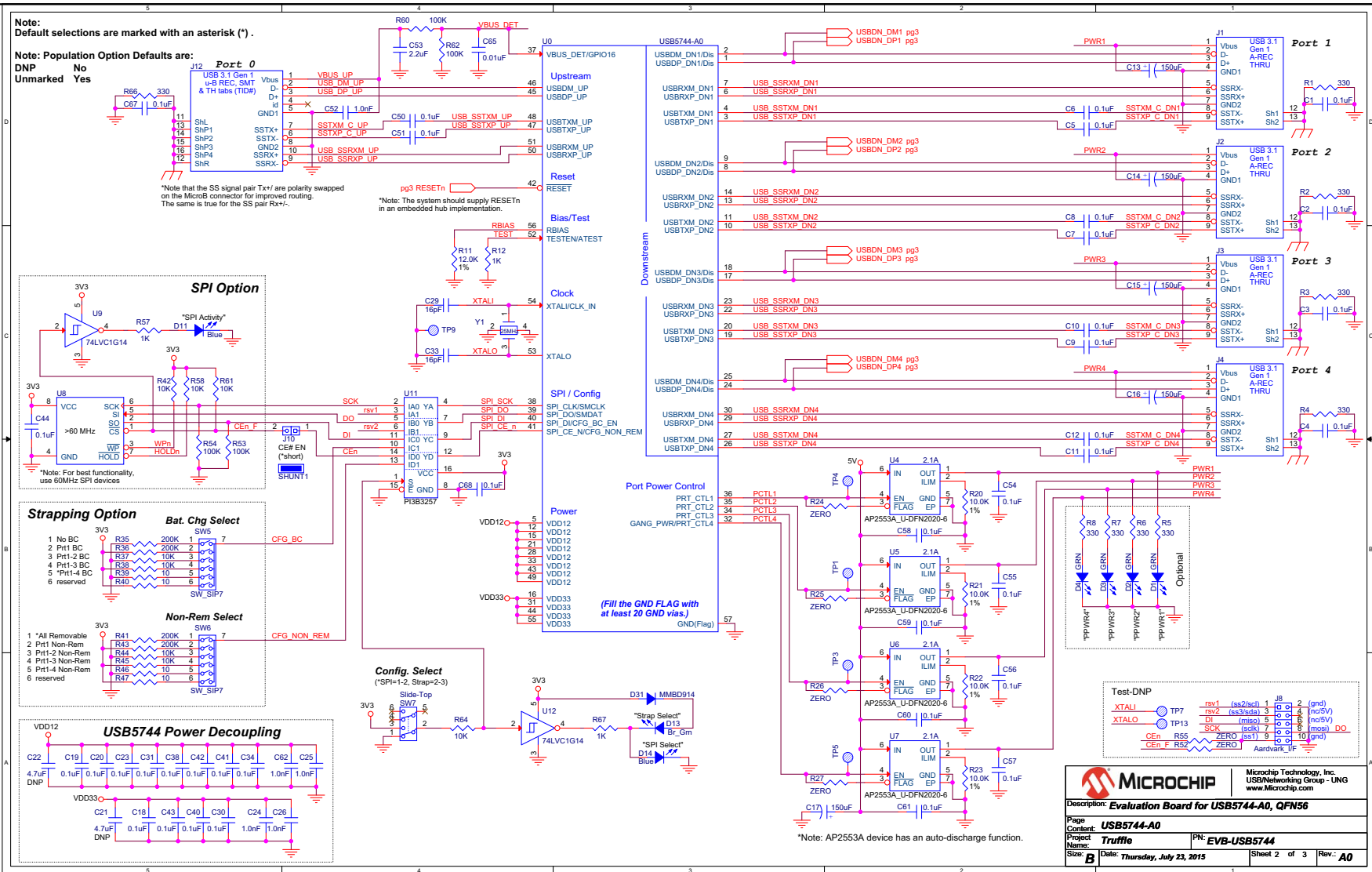
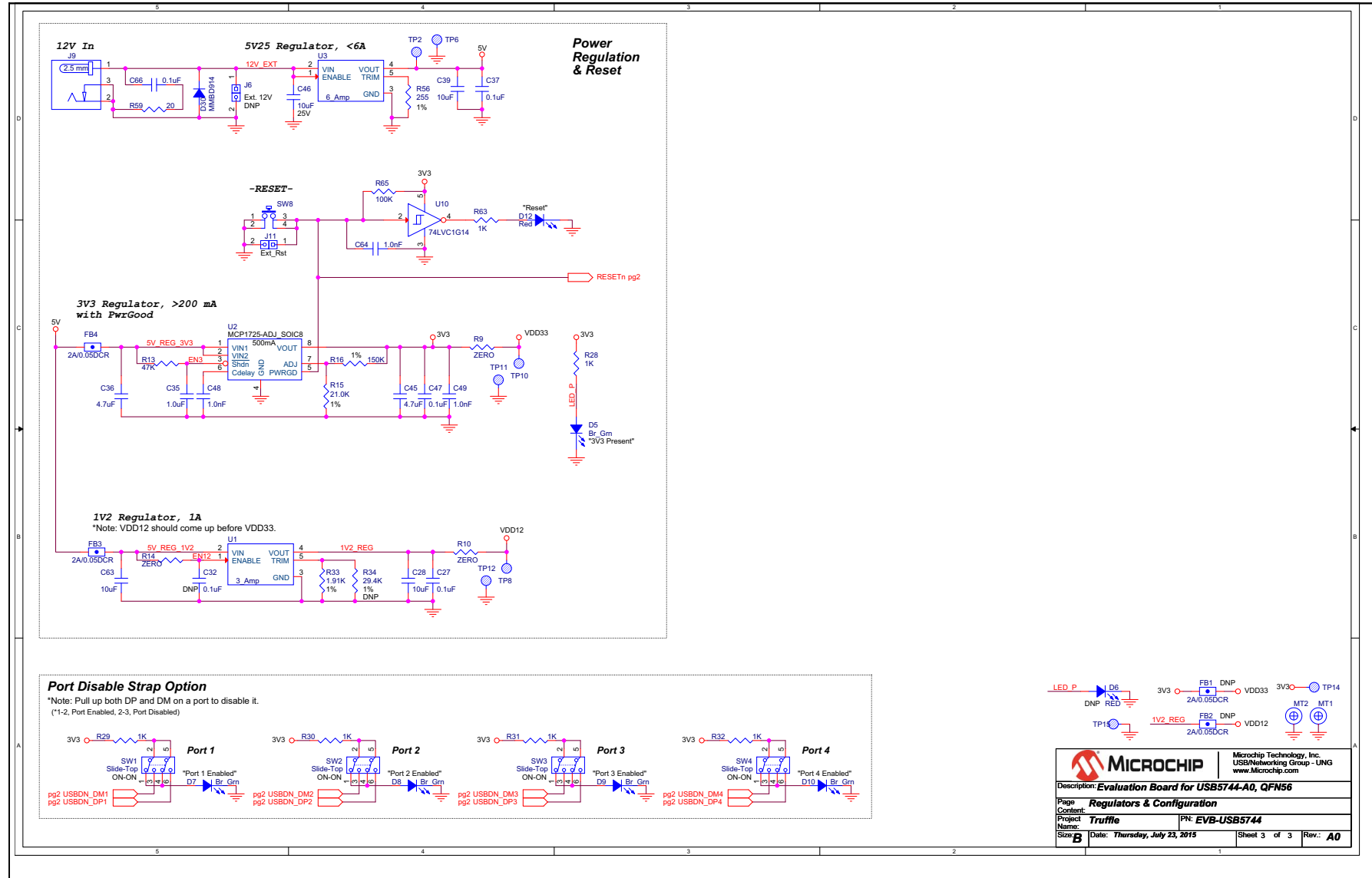

FIGURE B-2: EVB-USB5744 EVALUATION BOARD SCHEMATIC 2





Appendix C. Bill of Materials (BOM)

C.1 INTRODUCTION

This appendix includes the EVB-USB5744 Evaluation Board Bill of Materials (BOM).

TABLE C-1: EVB-USB5744 EVALUATION BOARD BILL OF MATERIALS

Item	Qty	Reference Designator(s)	Description	Manufacturer	Manufacturer Part Number
1	41	C1,C2,C3,C4,C5,C6,C7,C8,C9,C10,C11,C12,C18,C19,C20,C23,C27,C30,C31,C34,C37,C38,C40,C41,C42,C43,C44,C47,C50,C51,C54,C55,C56,C57,C58,C59,C60,C61,C66,C67,C68	Capacitor, 0.1uF, 10%, 25V, X5R, 0402	Murata	GRM155R61E104KA87D
2	5	C13,C14,C15,C16,C17	Capacitor, Low ESR, 150uF, 6.3VDC, 20%, Aluminum, Radial-SMT, 5mm x 5.7mm	Lelon	VZS151M0JTR-0506
4	8	C24,C25,C26,C48,C49,C52,C62,C64	Capacitor, 1000pF, 50V, 10%, X7R, 0402	Murata	GRM155R71H102KA01D
5	2	C28,C39	Capacitor, 10uF, 6.3VDC, 20%, X5R, 0603	Murata	GRM188R60J106ME47D
6	2	C29,C33	Capacitor, 16pF, 50V, 2%, NPO, 0402	Murata	GRM1555C1H160GA01D
8	1	C35	Capacitor, 1.0uF, 16VDC, 10%, X5R, 0603	Murata	GRM188R61C105KA93D
9	2	C36,C45	Capacitor, 4.7uF, 6.3VDC, 20%, X5R, 0603	Murata	GRM188R60J475KE19D
10	2	C46,C63	Capacitor, 10uF, 25 VDC, 10%, 0805	Murata	GRM21BR61E106KA73L
11	1	C53	Capacitor, 2.2uF, 6.3VDC, 10%, X5R, 0603	Murata	GRM185R60J225KE26D
12	1	C65	Capacitor, 0.01uF, 25V, 10%, X7R, 0402	Panasonic	ECJ-0EB1C103K
13	4	D1,D2,D3,D4	LED, Green, 3mm, Diffused, 0.2" CL-vert, TH, Right Angle	Lumex	SSF-LXH103GD
14	6	D5,D7,D8,D9,D10,D13	LED, Bright Green, 0603	Liteon	LTST-C191KGKT
16	2	D11,D14	LED, Blue, 0603	Stanley Electric	DB1111C-TR
17	1	D12	LED, Red, 0603	Stanley Electric	BR1111C-TR
18	2	D30,D31	Diode, MMBD914LT, Fast Switching, 100VDC, 200mA, SOT-23	On Semiconductors	MMBD914LT1
20	2	FB3,FB4	Ferrite Bead, 220 Ohm, 2A, 0.05DCR, 0603	Murata	BLM18EG221SN1D
21	9	R1,R2,R3,R4,R5,R6,R7,R8,R66	Resistor, 330, 5%, 1/16W, 0603	Panasonic	ERJ-3GEYJ331V
22	8	R9,R10,R14,R24,R25,R26,R27,R55	Resistor, ZERO, 0.1W, 0603	Panasonic	ERJ-3GEY0R00V
24	1	R11	Resistor, 12.0K, 1%, 1/16W, 0603	Panasonic	ERJ-3EKF1202V
25	9	R12,R28,R29,R30,R31,R32,R57,R63,R67	Resistor, 1K, 5%, 1/16W, 0603	Panasonic	ERJ-3GEYJ102V
26	1	R13	Resistor, 47K, 5%, 1/16W, 0603	Yageo America	9C06031A4702JLHFT
27	1	R15	Resistor, 21.0K, 1%, 1/10W, 0603	Panasonic	ERJ-3EKF2102V
28	1	R16	Resistor, 150K, 1%, 1/16W, 0603	Panasonic	ERJ-3EKF1503V
29	4	R20,R21,R22,R23	Resistor, 10.0K, 1%, 1/16W, 0603	Rohm	MCR03EZHF1002
30	1	R33	Resistor, 1.91K, 1%, 1/10W, 0603	Stackpole Electronics	RMCF0603FT1K91
32	4	R35,R36,R41,R43	Resistor, 200K, 5%, 1/10W, 0603	Vishay/Dale	CRCW0603200KJNEB
33	8	R37,R38,R42,R44,R45,R58,R61,R64	Resistor, 10K, 5%, 1/16W, 0603	Panasonic	ERJ-3GEYJ103V

TABLE C-1: EVB-USB5744 EVALUATION BOARD BILL OF MATERIALS (CONTINUED)

Item	Qty	Reference Designator(s)	Description	Manufacturer	Manufacturer Part Number
34	4	R39,R40,R46,R47	Resistor, 10, 5%, 1/16W, 0603	Yageo America	9C06031A10R0JLHFT
35	5	R53,R54,R60,R62,R65	Resistor, 100K, 5%, 1/16W, 0603	Panasonic	ERJ-3GEYJ104V
36	1	R56	Resistor, 255, 1%, 1/10W, 0603	Panasonic	ERJ-3EKF2550V
37	1	R59	Resistor, 20, 5%, 1/10W, 0603	Panasonic	ERJ-3GEYJ200V
39	2	J10,J11	Header, 1 x 2, 0.1 Inch, Vertical	FCI	68000-236HLF
41	1	J12	Receptacle, USB 3.1 Gen 1, Style MicroB, Right Angle, SMT, with TID#, TH Tabs	Hirose Electric Co Ltd	ZX360D-B-10P
42	4	J1,J2,J3,J4	Receptacle, USB 3.1 Gen 1, Style A, Right Angle, Through-hole	Amphenol	GSB311131HR
43	1	J9	Connector, Power Jack, 2.5 mm x 5.5 mm, 12 V, 4 A, Right Angle, TH	Cui Stack	PJ-002BH
44	5	SW1,SW2,SW3,SW4,SW7	Switch, DPDT, Slide, Sub-Mini, Top Actuator, TH	C&K	JS202011CQN
45	2	SW5,SW6	Switch Array, SPST, 6 Position, SIP-7	CK	SPA06B
46	1	SW8	Switch, Momentary, SPST, 50mA, J-lead, NO, MicroMini	C&K Components	PTS810 SJM 250 SMTR LFS
47	1	U0	IC, USB5744 USB 3.1 Gen 1 Hub, 4 port, QFN56	Microchip	USB5744_A0
48	1	U1	IC, DC-DC Converter Module, 0.591-6 Vout, ~12 Vin, 0.591-6 VDC out, 3A, 5 pin SIP, 0.41" Wide	Murata	OKR-T/3-W12-C
49	1	U3	IC, DC-DC Converter Module, 0.591-6 Vout, ~12 Vin, 0.591-6 VDC out, 6A, 5 pin SIP, 0.41" Wide	Murata	OKR-T/6-W12-C
50	1	U2	IC, MCP1725-ADJE/SN, LDO Regulator, Adj., 500 mA, SOIC8	Microchip	MCP1725(T)-ADJE/SN
51	4	U4,U5,U6,U7	IC, AP2553AFDC-7, Power Distribution Switch, U-DFN2020-6	Diodes Inc.	AP2553AFDC-7
52	1	U8	IC, Flash, SPI, SST25VF064C, 64Mb (8M x 8), 2.7V-3.3V, 75MHz (Dual Read), SO8	Microchip	SST25VF064C-80-4I-S3AE
53	3	U9,U10,U12	IC, 74LVC1G14, Inverter, Shottky, DCK	TI	SN74LVC1G14DCKR
54	1	U11	IC, PI3B3257, Quad 2:1 Mux, 3.3V, QSOP-16	Pericom	PI3B3257QE
55	1	Y1	Crystal, 25.000MHz, 30ppm, 10pF, SMT 3.2MM X 2.5MM	Abrakon	ABM8G-25.000MHZ-B4Y-T
56	2	SHUNT1	Shunt, Insulated, 0.1 Inch	TE Connectivity	881545-2
57	4	-none	Foot, Silicone Rubber, Adhesive, Clear, Cylindrical, .500"x.250"	Bumper Specialties	RBS-6
58	1	LBL-SERNO	Label, Serial Number, Laminated, 250 x 800	Brother	1/4" x 0.8"
59	1	LBL-ASSY1	Label, Assembly Number, Laminated, 250 x 800, "EVB-USB5744_A0"	Brother	1/4" x 0.8"
60	1	PCB Fab	PCB, Truffle (EVB-USB5744), Rev. A		Truffle_A
61	1	Assembly	Assembly, Truffle (EVB-USB5744), Rev. A0		Truffle_A0

FIGURE D-2: EVB-USB5744 BOTTOM SILK SCREEN

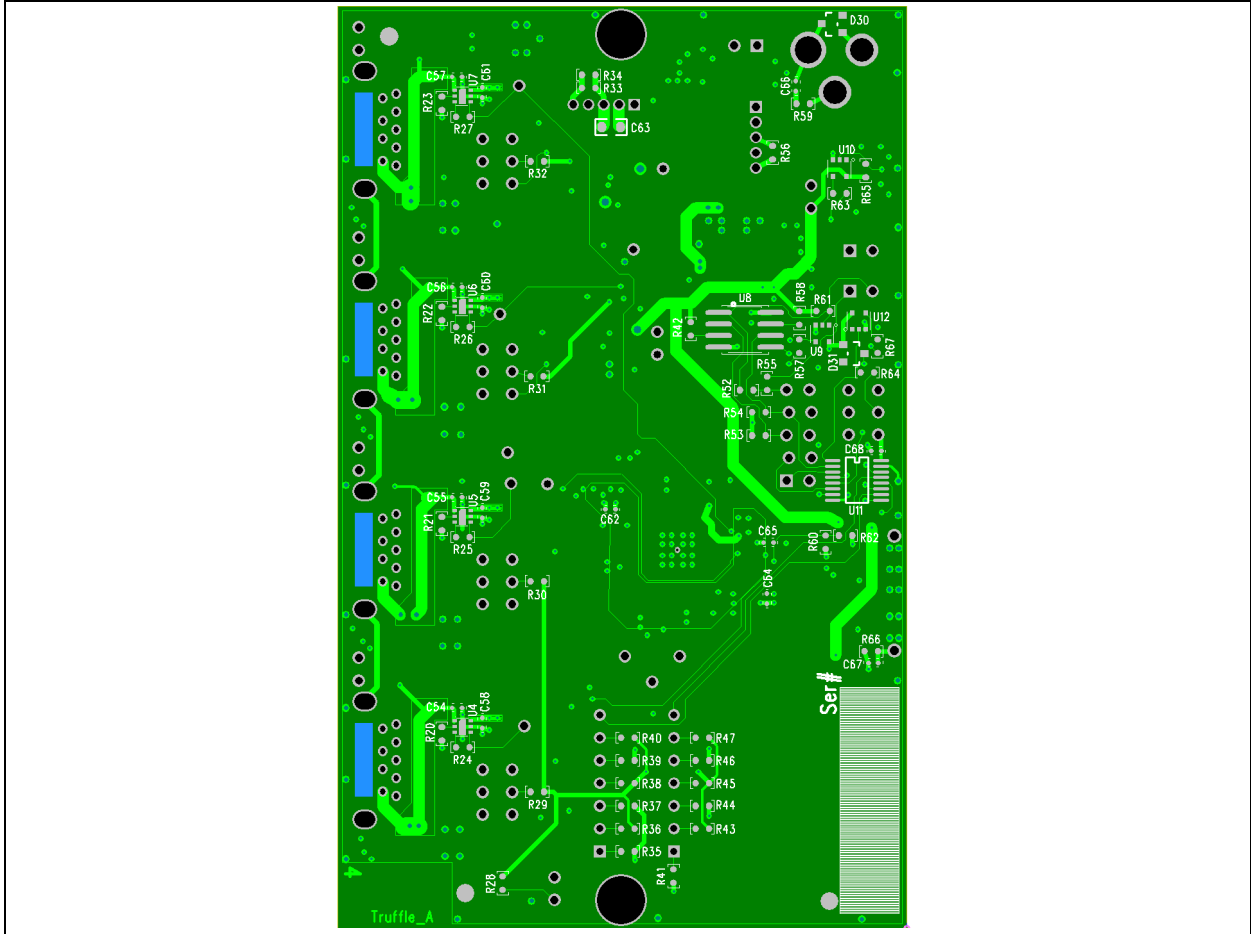



MICROCHIP

Worldwide Sales and Service

AMERICAS

Corporate Office

2355 West Chandler Blvd.
Chandler, AZ 85224-6199

Tel: 480-792-7200

Fax: 480-792-7277

Technical Support:

[http://www.microchip.com/
support](http://www.microchip.com/support)

Web Address:

www.microchip.com

Atlanta

Duluth, GA

Tel: 678-957-9614

Fax: 678-957-1455

Austin, TX

Tel: 512-257-3370

Boston

Westborough, MA

Tel: 774-760-0087

Fax: 774-760-0088

Chicago

Itasca, IL

Tel: 630-285-0071

Fax: 630-285-0075

Cleveland

Independence, OH

Tel: 216-447-0464

Fax: 216-447-0643

Dallas

Addison, TX

Tel: 972-818-7423

Fax: 972-818-2924

Detroit

Novi, MI

Tel: 248-848-4000

Houston, TX

Tel: 281-894-5983

Indianapolis

Noblesville, IN

Tel: 317-773-8323

Fax: 317-773-5453

Los Angeles

Mission Viejo, CA

Tel: 949-462-9523

Fax: 949-462-9608

New York, NY

Tel: 631-435-6000

San Jose, CA

Tel: 408-735-9110

Canada - Toronto

Tel: 905-673-0699

Fax: 905-673-6509

ASIA/PACIFIC

Asia Pacific Office

Suites 3707-14, 37th Floor
Tower 6, The Gateway
Harbour City, Kowloon

Hong Kong

Tel: 852-2943-5100

Fax: 852-2401-3431

Australia - Sydney

Tel: 61-2-9868-6733

Fax: 61-2-9868-6755

China - Beijing

Tel: 86-10-8569-7000

Fax: 86-10-8528-2104

China - Chengdu

Tel: 86-28-8665-5511

Fax: 86-28-8665-7889

China - Chongqing

Tel: 86-23-8980-9588

Fax: 86-23-8980-9500

China - Dongguan

Tel: 86-769-8702-9880

China - Hangzhou

Tel: 86-571-8792-8115

Fax: 86-571-8792-8116

China - Hong Kong SAR

Tel: 852-2943-5100

Fax: 852-2401-3431

China - Nanjing

Tel: 86-25-8473-2460

Fax: 86-25-8473-2470

China - Qingdao

Tel: 86-532-8502-7355

Fax: 86-532-8502-7205

China - Shanghai

Tel: 86-21-5407-5533

Fax: 86-21-5407-5066

China - Shenyang

Tel: 86-24-2334-2829

Fax: 86-24-2334-2393

China - Shenzhen

Tel: 86-755-8864-2200

Fax: 86-755-8203-1760

China - Wuhan

Tel: 86-27-5980-5300

Fax: 86-27-5980-5118

China - Xian

Tel: 86-29-8833-7252

Fax: 86-29-8833-7256

ASIA/PACIFIC

China - Xiamen

Tel: 86-592-2388138

Fax: 86-592-2388130

China - Zhuhai

Tel: 86-756-3210040

Fax: 86-756-3210049

India - Bangalore

Tel: 91-80-3090-4444

Fax: 91-80-3090-4123

India - New Delhi

Tel: 91-11-4160-8631

Fax: 91-11-4160-8632

India - Pune

Tel: 91-20-3019-1500

Japan - Osaka

Tel: 81-6-6152-7160

Fax: 81-6-6152-9310

Japan - Tokyo

Tel: 81-3-6880-3770

Fax: 81-3-6880-3771

Korea - Daegu

Tel: 82-53-744-4301

Fax: 82-53-744-4302

Korea - Seoul

Tel: 82-2-554-7200

Fax: 82-2-558-5932 or

82-2-558-5934

Malaysia - Kuala Lumpur

Tel: 60-3-6201-9857

Fax: 60-3-6201-9859

Malaysia - Penang

Tel: 60-4-227-8870

Fax: 60-4-227-4068

Philippines - Manila

Tel: 63-2-634-9065

Fax: 63-2-634-9069

Singapore

Tel: 65-6334-8870

Fax: 65-6334-8850

Taiwan - Hsin Chu

Tel: 886-3-5778-366

Fax: 886-3-5770-955

Taiwan - Kaohsiung

Tel: 886-7-213-7828

Taiwan - Taipei

Tel: 886-2-2508-8600

Fax: 886-2-2508-0102

Thailand - Bangkok

Tel: 66-2-694-1351

Fax: 66-2-694-1350

EUROPE

Austria - Wels

Tel: 43-7242-2244-39

Fax: 43-7242-2244-393

Denmark - Copenhagen

Tel: 45-4450-2828

Fax: 45-4485-2829

France - Paris

Tel: 33-1-69-53-63-20

Fax: 33-1-69-30-90-79

Germany - Dusseldorf

Tel: 49-2129-3766400

Germany - Karlsruhe

Tel: 49-721-625370

Germany - Munich

Tel: 49-89-627-144-0

Fax: 49-89-627-144-44

Italy - Milan

Tel: 39-0331-742611

Fax: 39-0331-466781

Italy - Venice

Tel: 39-049-7625286

Netherlands - Drunen

Tel: 31-416-690399

Fax: 31-416-690340

Poland - Warsaw

Tel: 48-22-3325737

Spain - Madrid

Tel: 34-91-708-08-90

Fax: 34-91-708-08-91

Sweden - Stockholm

Tel: 46-8-5090-4654

UK - Wokingham

Tel: 44-118-921-5800

Fax: 44-118-921-5820

07/14/15

Mouser Electronics

Authorized Distributor

Click to View Pricing, Inventory, Delivery & Lifecycle Information:

[Microchip:](#)

[EVB-USB5744](#)



Компания «ЭлектроПласт» предлагает заключение долгосрочных отношений при поставках импортных электронных компонентов на взаимовыгодных условиях!

Наши преимущества:

- Оперативные поставки широкого спектра электронных компонентов отечественного и импортного производства напрямую от производителей и с крупнейших мировых складов;
- Поставка более 17-ти миллионов наименований электронных компонентов;
- Поставка сложных, дефицитных, либо снятых с производства позиций;
- Оперативные сроки поставки под заказ (от 5 рабочих дней);
- Экспресс доставка в любую точку России;
- Техническая поддержка проекта, помощь в подборе аналогов, поставка прототипов;
- Система менеджмента качества сертифицирована по Международному стандарту ISO 9001;
- Лицензия ФСБ на осуществление работ с использованием сведений, составляющих государственную тайну;
- Поставка специализированных компонентов (Xilinx, Altera, Analog Devices, Intersil, Interpoint, Microsemi, Aeroflex, Peregrine, Syfer, Eurofarad, Texas Instrument, Miteq, Cobham, E2V, MA-COM, Hittite, Mini-Circuits, General Dynamics и др.);

Помимо этого, одним из направлений компании «ЭлектроПласт» является направление «Источники питания». Мы предлагаем Вам помощь Конструкторского отдела:

- Подбор оптимального решения, техническое обоснование при выборе компонента;
- Подбор аналогов;
- Консультации по применению компонента;
- Поставка образцов и прототипов;
- Техническая поддержка проекта;
- Защита от снятия компонента с производства.



Как с нами связаться

Телефон: 8 (812) 309 58 32 (многоканальный)

Факс: 8 (812) 320-02-42

Электронная почта: org@eplast1.ru

Адрес: 198099, г. Санкт-Петербург, ул. Калинина, дом 2, корпус 4, литера А.