



■ Features :

- 115VAC or 230VAC models available
- Built-in active PFC function
- Constant current design
- Protections: Short circuit / Over temperature
- Cooling by free air convection
- Fully isolated plastic case
- Class 2 Power Unit
- Class II power unit, no FG
- IP42 design
- Suitable for LED related fixture or appliance (such as LED Decoration or Advertisement devices)
- 100% full load burn-in test
- Low cost
- High reliability
- 3 years warranty



PLD-16-350 [A] A : With AC input 90~ 135VAC.
 B : With AC input 180~ 295VAC.

SPECIFICATION

MODEL	PLD-16-350 □	PLD-16-700 □	PLD-16-1050 □	PLD-16-1400 □		
OUTPUT	RATED CURRENT	350mA	700mA	1050mA	1400mA	
	OPERATING VOLTAGE RANGE	24 ~ 48V	16 ~ 24V	12 ~ 16V	8 ~ 12V	
	CURRENT ACCURACY	±5.0%				
	RATED POWER	16.8W	16.8W	16.8W	16.8W	
	RIPPLE & NOISE (max.) Note.1	4.6Vp-p	2.7Vp-p	2.2Vp-p	2Vp-p	
	NO LOAD OUTPUT VOLTAGE (max.)	60V	35V	25V	16V	
	SETUP TIME	500ms / 230VAC 2000ms / 115VAC at full load				
INPUT	FREQUENCY RANGE	47 ~ 63Hz				
	POWER FACTOR (Typ.)	PF>0.9/115VAC, PF>0.9/230VAC, PF>0.9/277VAC at full load (Please refer to "Power Factor Characteristic" curve)				
	TOTAL HARMONIC DISTORTION	A series	THD< 20% when output loading≥70% at 115VAC			
		B series	THD< 20% when output loading≥70% at 230VAC input and output loading≥80% at 277VAC input			
	EFFICIENCY (Typ.)	A series	84.5%	84.5%	84%	82.5%
		B series	85.5%	86%	85%	83.5%
	AC CURRENT (Typ.)	0.4A/115VAC	0.2A/230VAC	0.15A/277VAC		
	INRUSH CURRENT(Typ.)	COLD START 20A(twidth=25μs measured at 50% Ipeak) at 230VAC				
MAX. No. of PSUs on 16A CIRCUIT BREAKER	A series	58 units (circuit breaker of type B) / 58 units (circuit breaker of type C) at 115VAC				
	B series	128 units (circuit breaker of type B) / 128 units (circuit breaker of type C) at 230VAC				
LEAKAGE CURRENT	<0.5mA / 240VAC					
PROTECTION	SHORT CIRCUIT	Hiccup mode, recovers automatically after fault condition is removed.				
	OVER TEMPERATURE	Shut down o/p voltage, re-power on to recover				
ENVIRONMENT	WORKING TEMP.	-30 ~ +50°C (Refer to "Derating Curve")				
	WORKING HUMIDITY	20 ~ 95% RH non-condensing				
	STORAGE TEMP., HUMIDITY	-40 ~ +80°C, 10 ~ 95% RH				
	TEMP. COEFFICIENT	±0.03%/°C (0 ~ 50°C)				
	VIBRATION	10 ~ 500Hz, 2G 12min./1cycle, period for 72min. each along X, Y, Z axes				
SAFETY & EMC	SAFETY STANDARDS	UL8750, CSA C22.2 No.250.0-08;ENEC EN 613471-1,EN 61347-2-13 independent, EN62384(for B type only), EAC TP TC 004, IP42 approved				
	WITHSTAND VOLTAGE	I/P-O/P:3.75KVAC				
	ISOLATION RESISTANCE	I/P-O/P:100M Ohms / 500VDC / 25°C/ 70% RH				
	EMC EMISSION	Compliance to EN55015 (B type only), EN61000-3-2 Class C ; EN61000-3-3, FCC part 18 non-consumer equipment(A type only), EAC TP TC 020				
	EMC IMMUNITY	Compliance to EN61000-4-2,3,4,5,6,8,11, EN61547, light industry level, criteria A, EAC TP TC 020				
OTHERS	MTBF	906.5Khrs min. MIL-HDBK-217F (25°C)				
	DIMENSION	84*57*29.5mm (L*W*H)				
	PACKING	0.19Kg; 72pcs/14.7Kg/0.92CUFT				
NOTE	1. Ripple & noise are measured at 20MHz of bandwidth by using a 12" twisted pair-wire terminated with a 0.1uf & 47uf parallel capacitor. 2. Direct connecting to LEDs is suggested, but is not suitable for using additional drivers. 3. To fulfill requirements of the latest ErP regulation for lighting fixtures, this LED power supply can only be used behind a switch without permanently connected to the mains. 4. The ambient temperature derating of 3.5°C/1000m with fanless models and of 5°C/1000m with fan models for operating altitude higher than 2000m(6500ft). 5. For any application note and IP water proof function installation caution, please refer our user manual before using. https://www.meanwell.com/Upload/PDF/LED_LED.pdf					

Mechanical Specification

Case No. PCD16A Unit: mm

A Type: (PLD-16_A)

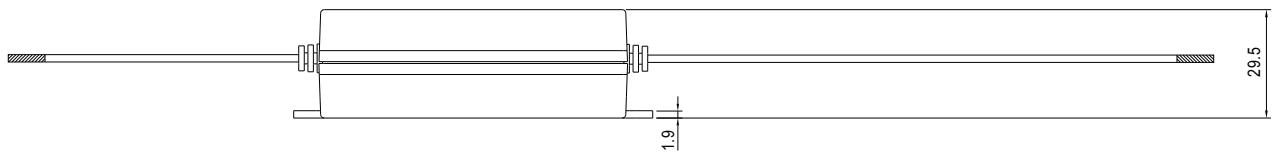
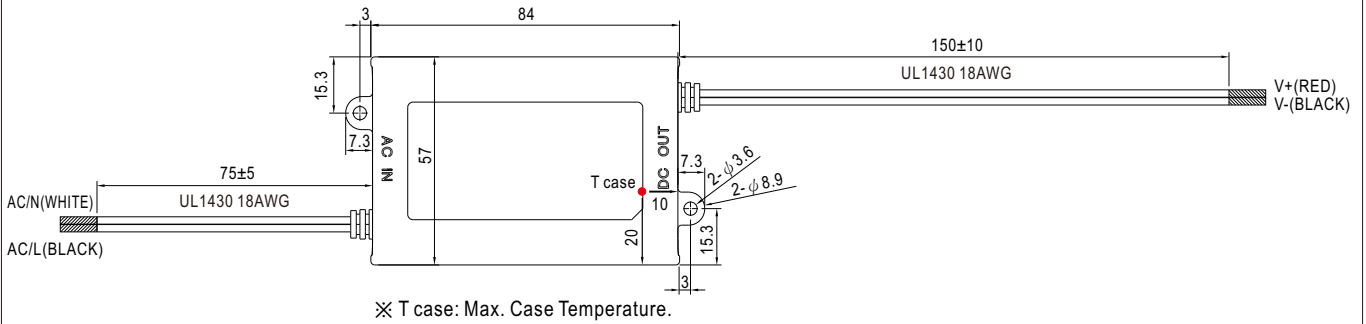

B Type: (PLD-16_B)

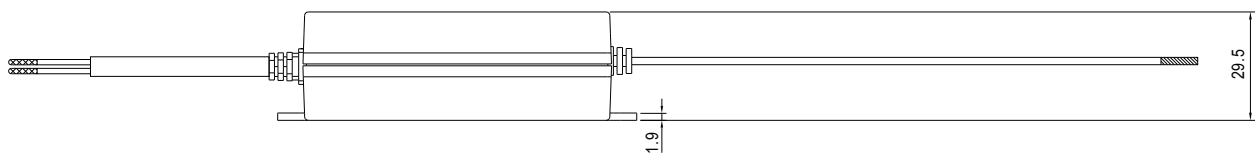
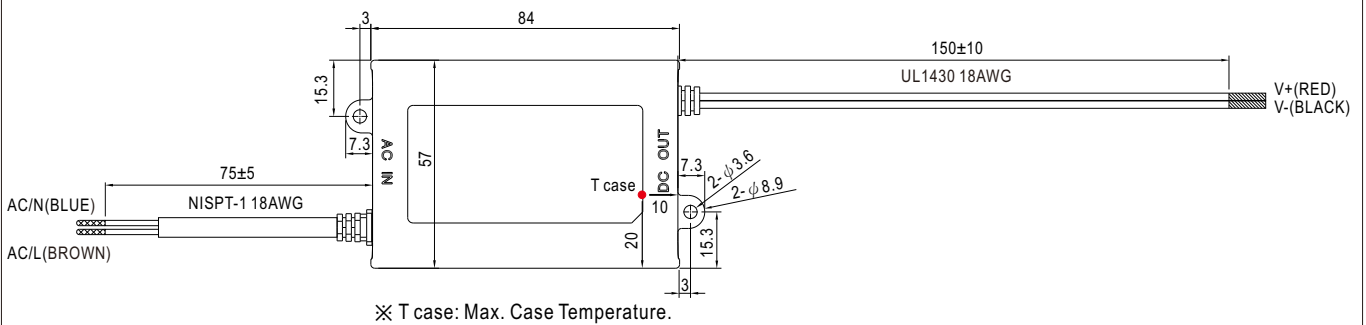

Block Diagram

fosc : 90KHz(115VAC)
120KHz(230VAC)

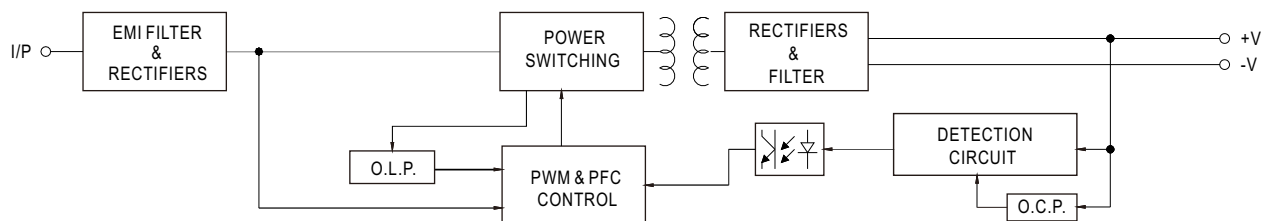

■ Derating Curve

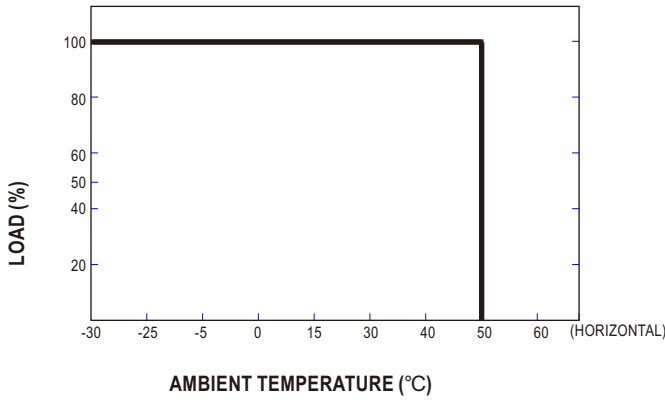

■ Static Characteristics

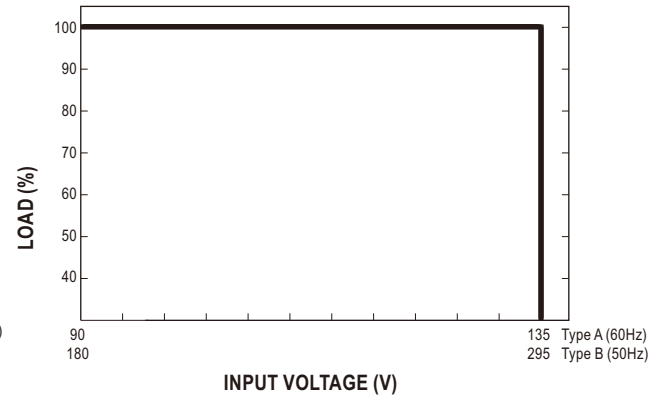

■ Power Factor Characteristic

Constant Current Mode

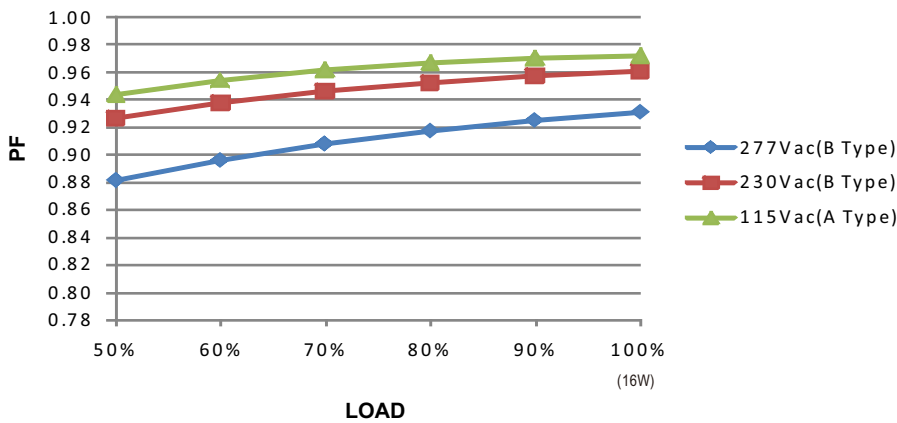

■ EFFICIENCY vs LOAD (PLD-16-350)

PLD-16 series possess superior working efficiency that up to 85.5% can be reached in field applications.





Компания «ЭлектроПласт» предлагает заключение долгосрочных отношений при поставках импортных электронных компонентов на взаимовыгодных условиях!

Наши преимущества:

- Оперативные поставки широкого спектра электронных компонентов отечественного и импортного производства напрямую от производителей и с крупнейших мировых складов;
- Поставка более 17-ти миллионов наименований электронных компонентов;
- Поставка сложных, дефицитных, либо снятых с производства позиций;
- Оперативные сроки поставки под заказ (от 5 рабочих дней);
- Экспресс доставка в любую точку России;
- Техническая поддержка проекта, помощь в подборе аналогов, поставка прототипов;
- Система менеджмента качества сертифицирована по Международному стандарту ISO 9001;
- Лицензия ФСБ на осуществление работ с использованием сведений, составляющих государственную тайну;
- Поставка специализированных компонентов (Xilinx, Altera, Analog Devices, Intersil, Interpoint, Microsemi, Aeroflex, Peregrine, Syfer, Eurofarad, Texas Instrument, Miteq, Cobham, E2V, MA-COM, Hittite, Mini-Circuits, General Dynamics и др.);

Помимо этого, одним из направлений компании «ЭлектроПласт» является направление «Источники питания». Мы предлагаем Вам помощь Конструкторского отдела:

- Подбор оптимального решения, техническое обоснование при выборе компонента;
- Подбор аналогов;
- Консультации по применению компонента;
- Поставка образцов и прототипов;
- Техническая поддержка проекта;
- Защита от снятия компонента с производства.



Как с нами связаться

Телефон: 8 (812) 309 58 32 (многоканальный)

Факс: 8 (812) 320-02-42

Электронная почта: org@eplast1.ru

Адрес: 198099, г. Санкт-Петербург, ул. Калинина, дом 2, корпус 4, литера А.