

IEC Appliance Inlet C14 with Filter, Fuseholder 1- or 2-pole



Screw-on from front side  
with 2-pole fuseholder



Snap-in mounting from front side  
with 2-pole fuseholder



See below:  
[Approvals and Compliances](#)

**Description**

- Panel mount :  
Snap-in or screw-on mounting from front side
- 3 Functions :  
Appliance Inlet Protection class I , Fuseholder for fuse-links 5 x 20 mm  
2-pole , Line filter in standard and medical version
- Quick connect terminals 6.3 x 0.8 mm

**Unique Selling Proposition**

- Ultra-compact design
- Recessed faston connectors
- High quality filter case made of stainless steel
- Highly resistant since potted filter

**Characteristics**

- All single elements are already wired
- Plug removal necessary for fuse-link replacement
- Suitable for use in medical equipment according to IEC/UL 60601-1  
For applications according IEC/UL 62368-1 we recommend variants with bleed resistor

**References**

- Alternative: version without line filter [6220](#)
- Alternative: version with V-Lock [KFA](#)

**Weblinks**

[pdf data sheet](#), [html datasheet](#), [General Product Information](#), [Approvals](#), [Distributor-Stock-Check](#), [Accessories](#), [Detailed request for product](#)

**Technical Data**

Ratings IEC	1 - 10A @ Ta 40 °C / 250VAC; 50Hz
Ratings UL/CSA	1 - 10A @ Ta 40 °C / 250VAC; 60Hz
Leakage Current	standard < 0.5 mA (250V / 60Hz) medical < 5 µA (250 V / 60 Hz)
Dielectric Strength	> 1.7 kVDC between L-N > 2.7 kVDC between L/N-PE Test voltage (2 sec)
Allowable Operation Temperature	-25 °C to 85 °C
Climatic Category	25/085/21 acc. to IEC 60068-1
IP-Protection	from front side IP40 acc. to IEC 60529
Protection Class	Suitable for appliances with protection class I acc. to IEC 61140
Terminal	Quick connect terminals 6.3 x 0.8 mm
Panel Thickness S	Screw: max 8 mm Mounting screw torque max 0.5Nm Snap-in: 0.8mm to 3mm
Material: Housing	Thermoplastic, black, UL 94V-0

Appliance inlet/-outlet	C14 acc. to IEC 60320-1, UL 60320-1, CSA C22.2 no. 60320-1 (for cold conditions) pin-temperature 70 °C, 10A, Protection Class I
Fuseholder	2-pole, Shocksafe category PC2 acc. to IEC 60127-6, for fuse-links 5 x 20mm
Rated Power Acceptance @ Ta 23 °C	5 x 20: 1.6W (2-pole)
Power Acceptance @ Ta > 23°C	Admissible power acceptance at higher ambient temperature see derating curves
Line Filter	Standard and Medical Version, IEC 60939-2, UL 60939-3, CSA C22.2 no. 8 <a href="#">Technical Details</a>
MTBF	> 2'300'000h acc. to MIL-HB-217 F

**Approvals and Compliances**



Detailed information on product approvals, code requirements, usage instructions and detailed test conditions can be looked up in [Details about Approvals](#)

SCHURTER products are designed for use in industrial environments. They have approvals from independent testing bodies according to national and international standards. Products with specific characteristics and requirements such as required in the automotive sector according to IATF 16949, medical technology according to ISO 13485 or in the aerospace industry can be offered exclusively with customer-specific, individual agreements by SCHURTER.

## Approvals







The approval mark is used by the testing authorities to certify compliance with the safety requirements placed on electronic products.

Approval Reference Type: 5220

Approval Logo	Certificates	Certification Body	Description
	VDE Approvals	VDE	Certificate Number: 101307
	UL Approvals	UL	UL File Number: E495089



## Product standards

Product standards that are referenced

Organization	Design	Standard	Description
	Designed according to	IEC 60320-1	Appliance couplers for household and similar general purposes
	Designed according to	IEC 60939-2	Passive filters for suppressing electromagnetic interference
	Designed according to	IEC 60127-6	Miniature fuses. Part 6. Fuse-holders for miniature fuse-links
	Designed according to	UL 60320-1	Standard for Attachment Plugs and Receptacles
	Designed according to	UL 60939-3	Electromagnetic interference filters
	Designed according to	CSA C22.2 no. 60320-1	General Use Receptacles, Attachment Plugs, and Similar Wiring Devices
	Designed according to	CSA C22.2 no. 8	Electromagnetic interference (EMI) filters







## Application standards

Application standards where the product can be used

Organization	Design	Standard	Description
	Designed for applications acc.	IEC/UL 62368-1	IEC 62368-1 includes the basic requirements for safety of audio, video, information technology and office equipment.
	Designed for applications acc.	IEC 60601-1	Medical electrical equipment - Part 1: General requirements for basic safety and essential performance
	Designed for applications acc.	IEC 60335-1	Safety of electrical appliances for household and similar purposes. Meets the requirements for appliances in unattended use. This includes the enhanced requirements of glow wire tests acc. to IEC 60695-2-11 or -12 & -13.

## Compliances

The product complies with following Guide Lines

Identification	Details	Initiator	Description
	CE declaration of conformity	SCHURTER AG	The CE marking declares that the product complies with the applicable requirements laid down in the harmonisation of Community legislation on its affixing in accordance with EU Regulation 765/2008.
	RoHS	SCHURTER AG	Directive RoHS 2011/65/EU, Amendment (EU) 2015/863
	China RoHS	SCHURTER AG	The law SJ / T 11363-2006 (China RoHS) has been in force since 1 March 2007. It is similar to the EU directive RoHS.
	REACH	SCHURTER AG	On 1 June 2007, Regulation (EC) No 1907/2006 on the Registration, Evaluation, Authorization and Restriction of Chemicals 1 (abbreviated as "REACH") entered into force.
	White Paper Glow wire test	SCHURTER AG	Meets the requirements of IEC 60335-1 for appliances in unattended use. This includes the enhanced requirements of glow wire tests acc. to IEC 60695-2-11 or -12 & -13.
	Medical Equipment	SCHURTER AG	Suitable for use in medical equipment according to IEC/UL 60601-1

**Dimensions [mm]**

Screw-on mounting type 5220

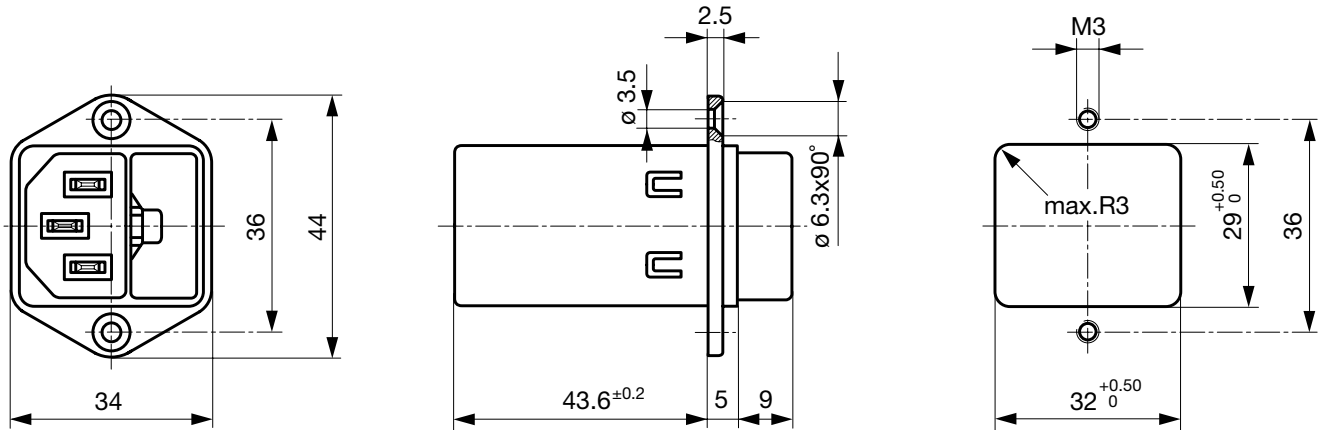

Snap-in mounting type 5220

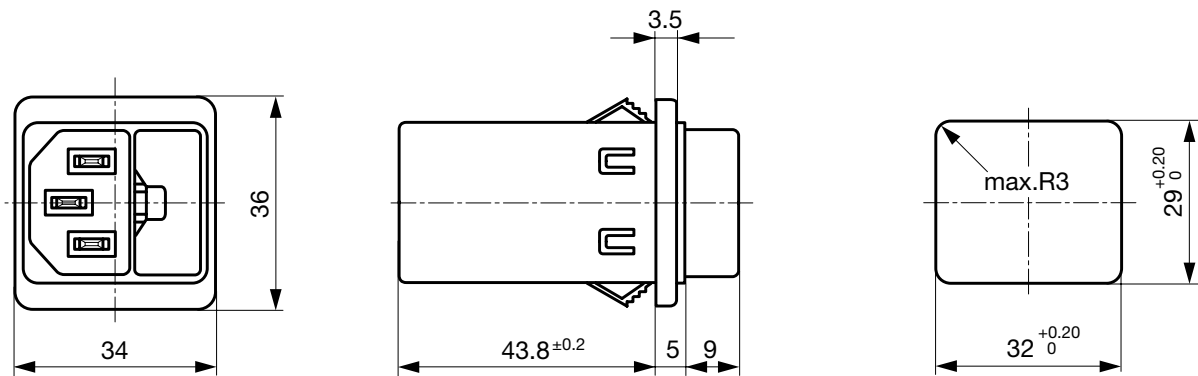

**Technical Data of Filter-Components**

Rated Current [A]	Filter-Type	Inductances L [mH]	Capacitance CX [nF]	Capacitance CY [nF]	R [MΩ]
1	Standard version	2 x 11	47	2.2	-
2	Standard version	2 x 4	47	2.2	-
4	Standard version	2 x 1.6	47	2.2	-
6	Standard version	2 x 0.7	47	2.2	-
8	Standard version	2 x 0.6	47	2.2	-
10	Standard version	2 x 0.4	47	2.2	-
1	Medical Version (M5)	2 x 11	47	-	1
2	Medical Version (M5)	2 x 4	47	-	1
4	Medical Version (M5)	2 x 1.6	47	-	1
6	Medical Version (M5)	2 x 0.7	47	-	1
8	Medical Version (M5)	2 x 0.6	47	-	1
10	Medical Version (M5)	2 x 0.4	47	-	1
10	Standard and Medical Version	2 x 11	47	2.2	1

Diagrams

5220 Standard Version

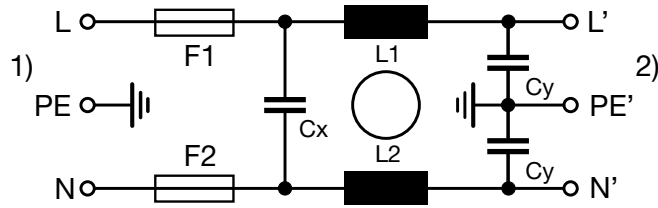

1) Line  
 2) Load

5220 Medical Version (M5)

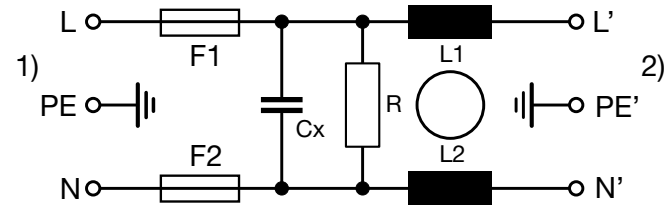

1) Line  
 2) Load

Derating Curves

2-pole

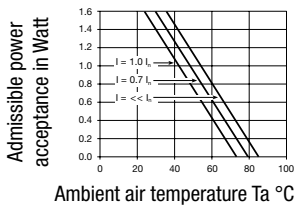

Attenuation Loss

--- 50Ω differential mode    \_\_\_ 50Ω common mode

Standard version

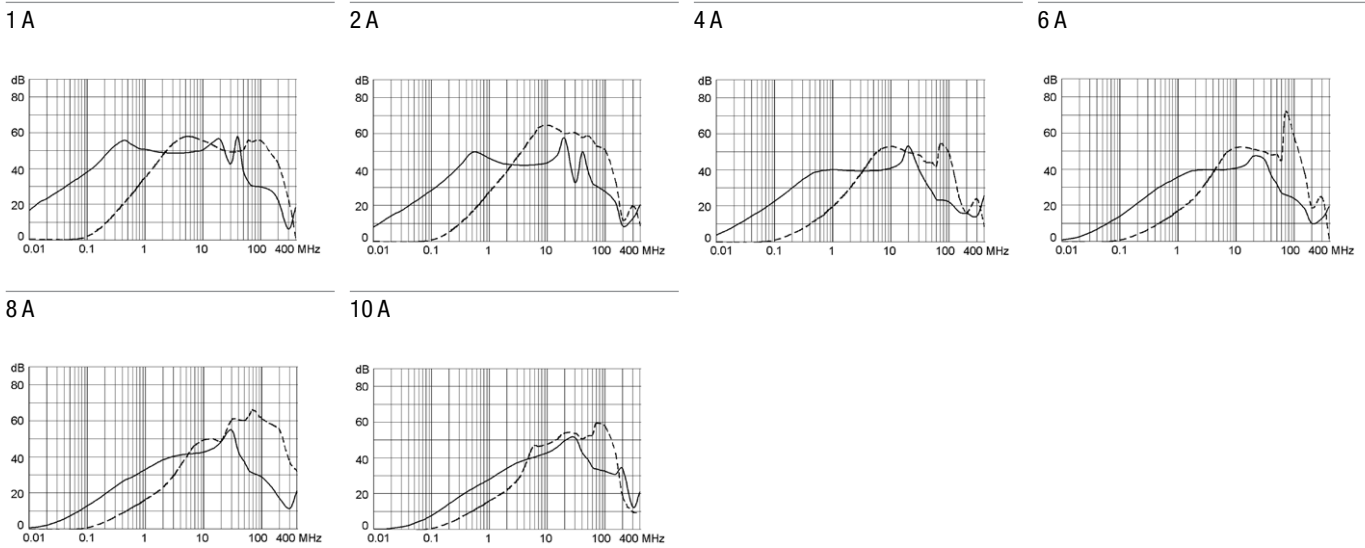

Medical version (M5)

1 A

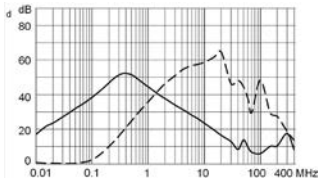

2 A

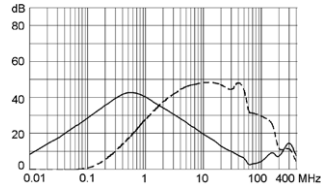

4 A

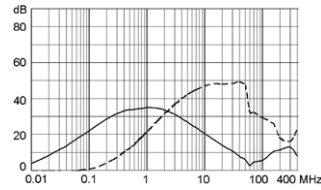

6 A

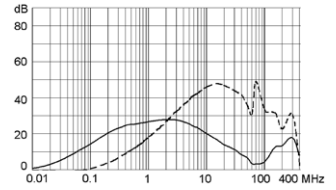

8 A

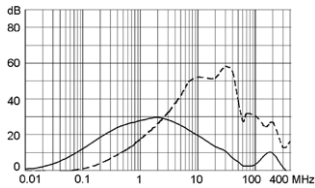

10 A

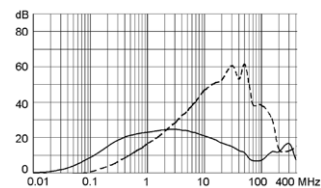

All Variants

Rated Current [A]	Filter-Type	Panel mounting	Fuseholder	Order Number
1	Standard version	Snap-in	2-pole	5220.0143.1
2	Standard version	Snap-in	2-pole	5220.0243.1
4	Standard version	Snap-in	2-pole	5220.0443.1
6	Standard version	Snap-in	2-pole	5220.0643.1
8	Standard version	Snap-in	2-pole	5220.0843.1
10	Standard version	Snap-in	2-pole	5220.1043.1
1	Standard version	Screw	2-pole	5220.0123.1
2	Standard version	Screw	2-pole	5220.0223.1
4	Standard version	Screw	2-pole	5220.0423.1
6	Standard version	Screw	2-pole	5220.0623.1
8	Standard version	Screw	2-pole	5220.0823.1
10	Standard version	Screw	2-pole	5220.1023.1
1	Medical Version (M5)	Snap-in	2-pole	5220.0143.3
2	Medical Version (M5)	Snap-in	2-pole	5220.0243.3
4	Medical Version (M5)	Snap-in	2-pole	5220.0443.3
6	Medical Version (M5)	Snap-in	2-pole	5220.0643.3
8	Medical Version (M5)	Snap-in	2-pole	5220.0843.3
10	Medical Version (M5)	Snap-in	2-pole	5220.1043.3
1	Medical Version (M5)	Screw	2-pole	5220.0123.3
2	Medical Version (M5)	Screw	2-pole	5220.0223.3
4	Medical Version (M5)	Screw	2-pole	5220.0423.3
6	Medical Version (M5)	Screw	2-pole	5220.0623.3
8	Medical Version (M5)	Screw	2-pole	5220.0823.3
10	Medical Version (M5)	Screw	2-pole	5220.1023.3

Most Popular.

Availability for all products can be searched real-time: <https://www.schurter.com/en/Stock-Check/Stock-Check-SCHURTER>

Packaging unit 10 Pcs

Accessories

Description

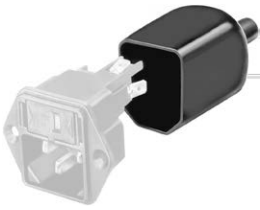

Assorted Covers  
 Rear Cover

0859.0047



Cord retaining kits  
 Cord retaining strain relief

Countersunk, B

4700.0002

Mating Outlets/Connectors

Category / Description

Appliance Outlet Overview complete



4787, Mounting: Screw-on mounting, Appliance Outlet: IEC Solder terminals, 10 A, Suitable for appliances with protection class I

4787

4788, Mounting: Snap-in version, Appliance Outlet: IEC Solder terminals or quick connect terminals, 10 A, Suitable for appliances with protection class I

4788

IEC Appliance Outlet F or H, Screw-on Mounting, Front Side, Solder, PCB or Quick-connect Terminal

5091

[Appliance Outlet further types to 5220](#)

Connector Overview complete



4782 Mounting: Power Cord, 3 x 1 mm<sup>2</sup> / 3 x 18 AWG, Cable, Connector: IEC C13

4782

4785 Mounting: Power Cord, 3 x 1 mm<sup>2</sup> / 3 x 18 AWG, Cable, Connector: IEC C13

4785

4012 Mounting: Power Supply Cord, 3 x 1 mm<sup>2</sup>, Screw clamps, Connector: IEC C13

4012

4300-06 Mounting: Power Cord, 3 x 1 mm<sup>2</sup> / 3 x 18 AWG, Cable, Connector: IEC C13

4300-06

4781 Mounting: Power Cord, 3 x 1 mm<sup>2</sup> / 3 x 18 AWG, Cable, Connector: IEC C15

4781

[Connector further types to 5220](#)

...



Компания «ЭлектроПласт» предлагает заключение долгосрочных отношений при поставках импортных электронных компонентов на взаимовыгодных условиях!

Наши преимущества:

- Оперативные поставки широкого спектра электронных компонентов отечественного и импортного производства напрямую от производителей и с крупнейших мировых складов;
- Поставка более 17-ти миллионов наименований электронных компонентов;
- Поставка сложных, дефицитных, либо снятых с производства позиций;
- Оперативные сроки поставки под заказ (от 5 рабочих дней);
- Экспресс доставка в любую точку России;
- Техническая поддержка проекта, помощь в подборе аналогов, поставка прототипов;
- Система менеджмента качества сертифицирована по Международному стандарту ISO 9001;
- Лицензия ФСБ на осуществление работ с использованием сведений, составляющих государственную тайну;
- Поставка специализированных компонентов (Xilinx, Altera, Analog Devices, Intersil, Interpoint, Microsemi, Aeroflex, Peregrine, Syfer, Eurofarad, Texas Instrument, Miteq, Cobham, E2V, MA-COM, Hittite, Mini-Circuits, General Dynamics и др.);

Помимо этого, одним из направлений компании «ЭлектроПласт» является направление «Источники питания». Мы предлагаем Вам помощь Конструкторского отдела:

- Подбор оптимального решения, техническое обоснование при выборе компонента;
- Подбор аналогов;
- Консультации по применению компонента;
- Поставка образцов и прототипов;
- Техническая поддержка проекта;
- Защита от снятия компонента с производства.



#### Как с нами связаться

**Телефон:** 8 (812) 309 58 32 (многоканальный)

**Факс:** 8 (812) 320-02-42

**Электронная почта:** [org@eplast1.ru](mailto:org@eplast1.ru)

**Адрес:** 198099, г. Санкт-Петербург, ул. Калинина, дом 2, корпус 4, литера А.