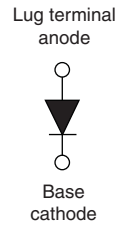

# HEXFRED®

## Ultrafast Soft Recovery Diode, 275 A

**HALF-PAK (D-67)**

**FEATURES**

- Very low  $Q_{rr}$  and  $t_{rr}$
- Designed and qualified for industrial level
- UL approved file E222165
- Material categorization:  
for definitions of compliance please see [www.vishay.com/doc?99912](http://www.vishay.com/doc?99912)

**RoHS**  
COMPLIANT

**BENEFITS**

- Reduced RFI and EMI
- Reduced snubbing

**DESCRIPTION**

HEXFRED® diodes are optimized to reduce losses and EMI/RFI in high frequency power conditioning systems. An extensive characterization of the recovery behavior for different values of current, temperature and  $di/dt$  simplifies the calculations of losses in the operating conditions. The softness of the recovery eliminates the need for a snubber in most applications. These devices are ideally suited for power converters, motors drives and other applications where switching losses are significant portion of the total losses.

PRODUCT SUMMARY	
$I_F$ (maximum)	275 A
$V_R$	400 V
$I_{F(DC)}$ at $T_C$	138 A at 100 °C
Package	HALF-PAK (D-67)
Circuit	Single diode

ABSOLUTE MAXIMUM RATINGS				
PARAMETER	SYMBOL	TEST CONDITIONS	VALUES	UNITS
Cathode to anode voltage	$V_R$		400	V
Continuous forward current	$I_F$	$T_C = 25\text{ °C}$	275	A
		$T_C = 100\text{ °C}$	138	
Single pulse forward current	$I_{FSM}$	Limited by junction temperature	900	
Non-repetitive avalanche energy	$E_{AS}$	$L = 100\ \mu\text{H}$ , duty cycle limited by maximum $T_J$	1.4	mJ
Maximum power dissipation	$P_D$	$T_C = 25\text{ °C}$	463	W
		$T_C = 100\text{ °C}$	185	
Operating junction and storage temperature range	$T_J, T_{Stg}$		-55 to +150	°C

ELECTRICAL SPECIFICATIONS ( $T_J = 25\text{ °C}$ unless otherwise specified)							
PARAMETER	SYMBOL	TEST CONDITIONS	MIN.	TYP.	MAX.	UNITS	
Cathode to anode breakdown voltage	$V_{BR}$	$I_R = 100\ \mu\text{A}$	400	-	-	V	
Maximum forward voltage	$V_{FM}$	$I_F = 135\text{ A}$	-	1.06	1.65		
		$I_F = 270\text{ A}$	-	1.2	2.0		
		$I_F = 135\text{ A}, T_J = 125\text{ °C}$	-	0.96	1.58		
Maximum reverse leakage current	$I_{RM}$	$T_J = 125\text{ °C}, V_R = 400\text{ V}$	See fig. 2	-	3	mA	
Junction capacitance	$C_T$	$V_R = 200\text{ V}$	See fig. 3	-	280	380	pF
Series inductance	$L_S$	From top of terminal hole to mounting plane	-	6.0	-	nH	



<b>DYNAMIC RECOVERY CHARACTERISTICS</b> ( $T_J = 25\text{ }^\circ\text{C}$ unless otherwise specified)							
PARAMETER	SYMBOL	TEST CONDITIONS		MIN.	TYP.	MAX.	UNITS
Reverse recovery time See fig. 5	$t_{rr}$	$T_J = 25\text{ }^\circ\text{C}$	$I_F = 135\text{ A}$ $di_F/dt = 200\text{ A}/\mu\text{s}$ $V_R = 200\text{ V}$	-	77	120	ns
		$T_J = 125\text{ }^\circ\text{C}$		-	280	440	
Peak recovery current See fig. 6	$I_{RRM}$	$T_J = 25\text{ }^\circ\text{C}$		-	7.5	14	A
		$T_J = 125\text{ }^\circ\text{C}$		-	15	30	
Reverse recovery charge See fig. 7	$Q_{rr}$	$T_J = 25\text{ }^\circ\text{C}$		-	150	780	nC
		$T_J = 125\text{ }^\circ\text{C}$		-	2800	6300	
Peak rate of recovery current See fig. 8	$di_{(rec)M}/dt$	$T_J = 25\text{ }^\circ\text{C}$		-	350	-	A/ $\mu\text{s}$
		$T_J = 125\text{ }^\circ\text{C}$		-	300	-	

<b>THERMAL - MECHANICAL SPECIFICATIONS</b>				
PARAMETER	SYMBOL	TEST CONDITIONS	VALUES	UNITS
Maximum junction and storage temperature range	$T_J, T_{Stg}$		-55 to +150	$^\circ\text{C}$
Maximum thermal resistance, junction to case	$R_{thJC}$	DC operation See fig. 4	0.27	$^\circ\text{C}/\text{W}$
Typical thermal resistance, case to heatsink	$R_{thCS}$	Mounting surface, flat, smooth and greased	0.05	
Approximate weight			30	g
			1.06	oz.
Mounting torque	minimum		3 (26.5)	N · m (lbf · in)
	maximum		4 (35.4)	
Terminal torque	minimum		3.4 (30)	
	maximum		5 (44.2)	
Case style		HALF-PAK module		

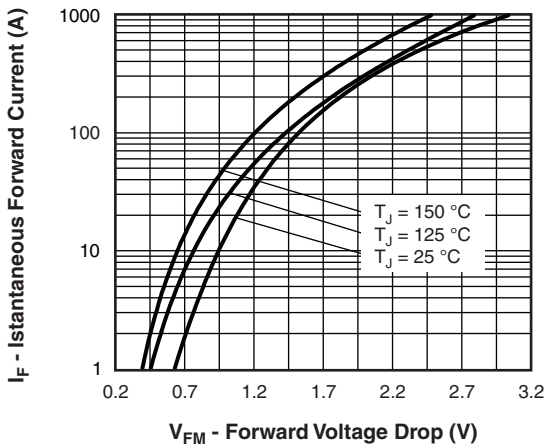

Fig. 1 - Maximum Forward Voltage Drop vs. Instantaneous Forward Current

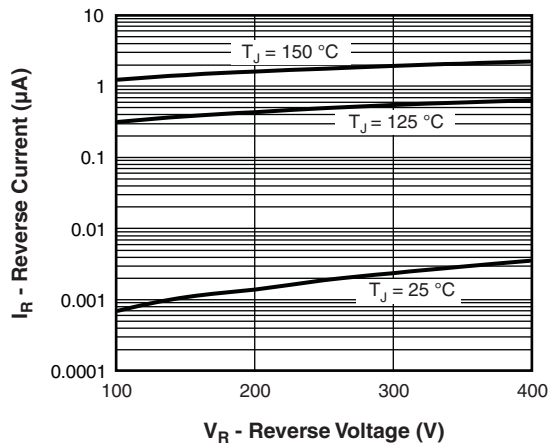

Fig. 2 - Typical Reverse Current vs. Reverse Voltage

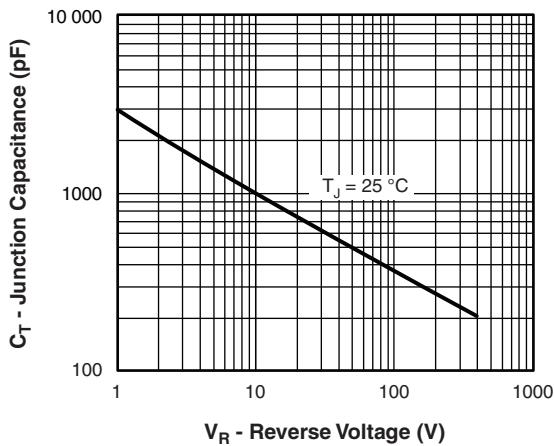

Fig. 3 - Typical Junction Capacitance vs. Reverse Voltage

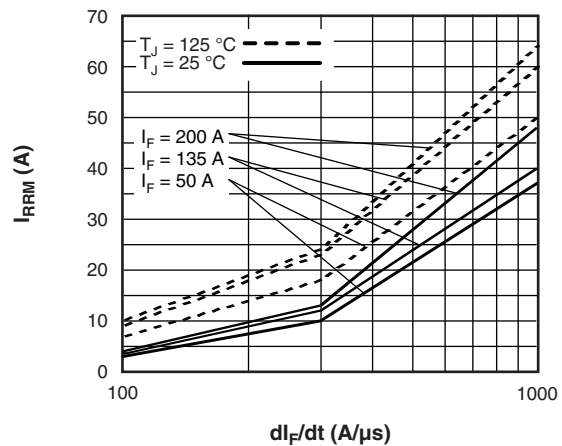

Fig. 6 - Typical Recovery Current vs.  $di_F/dt$

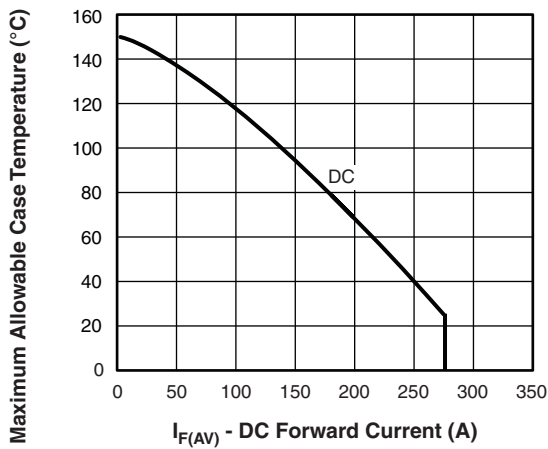

Fig. 4 - Maximum Allowable Case Temperature vs. DC Forward Current

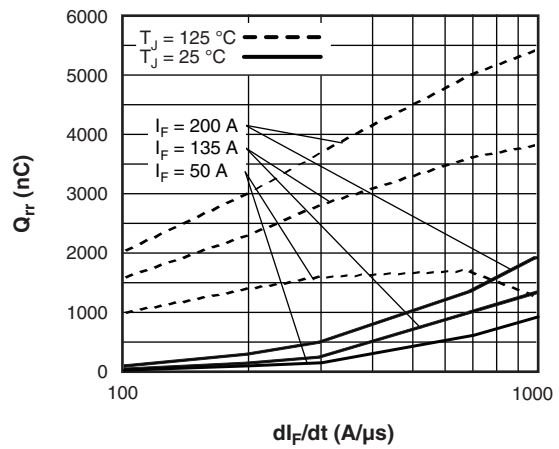

Fig. 7 - Typical Stored Charge vs.  $di_F/dt$

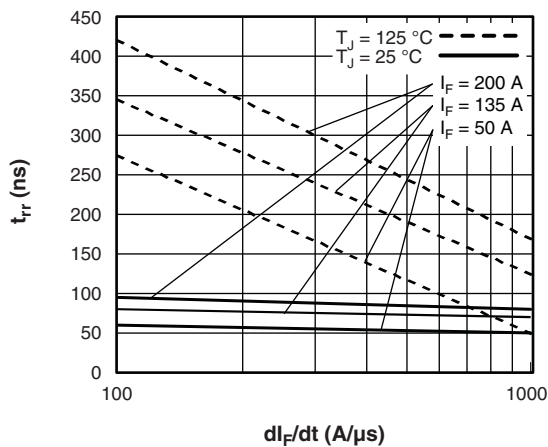

Fig. 5 - Typical Reverse Recovery Time vs.  $di_F/dt$

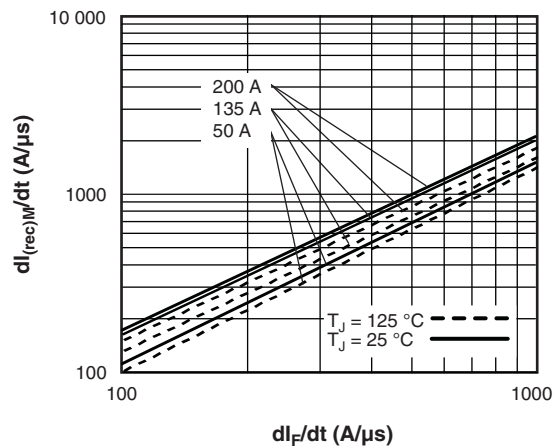

Fig. 8 - Typical  $di_{(rec)M}/dt$  vs.  $di_F/dt$

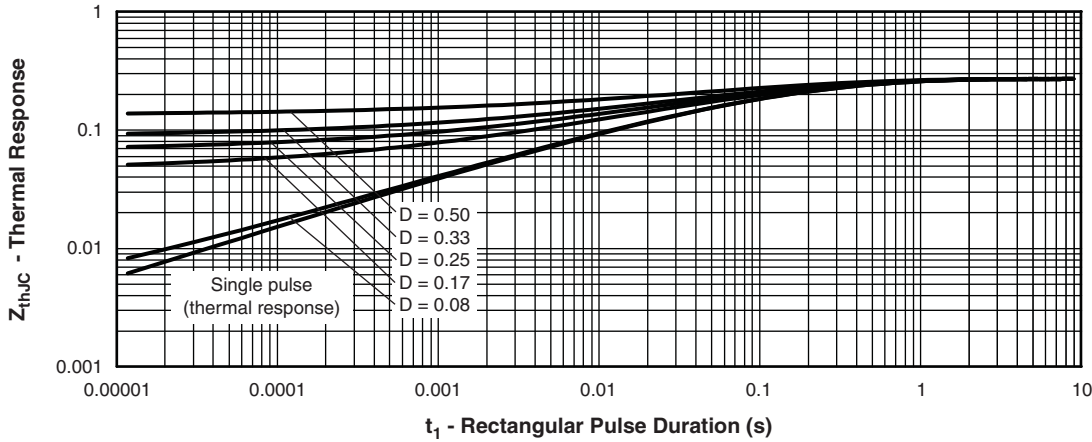

Fig. 9 - Maximum Thermal Impedance  $Z_{thJC}$  Characteristics

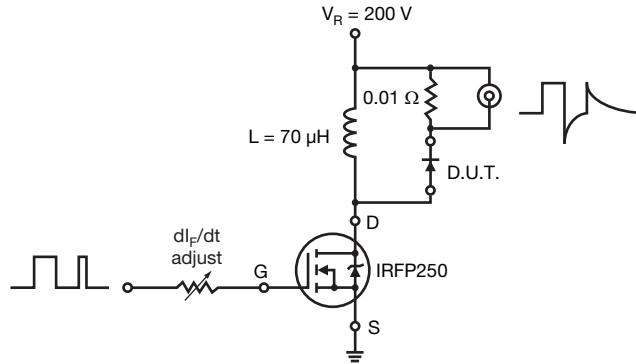
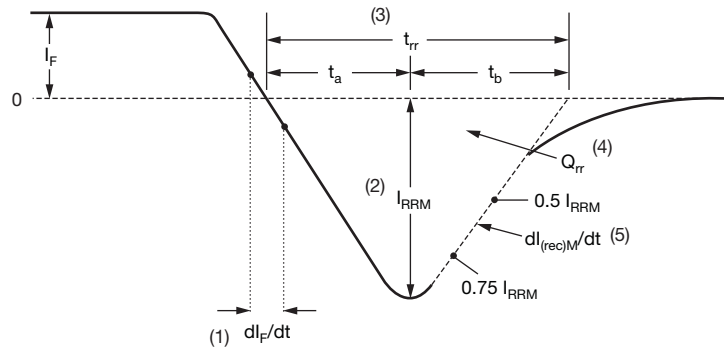

Fig. 10 - Reverse Recovery Parameter Test Circuit



- (1)  $di_F/dt$  - rate of change of current through zero crossing
- (2)  $I_{RRM}$  - peak reverse recovery current
- (3)  $t_{rr}$  - reverse recovery time measured from zero crossing point of negative going  $I_F$  to point where a line passing through  $0.75 I_{RRM}$  and  $0.50 I_{RRM}$  extrapolated to zero current.
- (4)  $Q_{rr}$  - area under curve defined by  $t_{rr}$  and  $I_{RRM}$
- (5)  $di_{(rec)M}/dt$  - peak rate of change of current during  $t_b$  portion of  $t_{rr}$

$$Q_{rr} = \frac{t_{rr} \times I_{RRM}}{2}$$

Fig. 11 - Reverse Recovery Waveform and Definitions

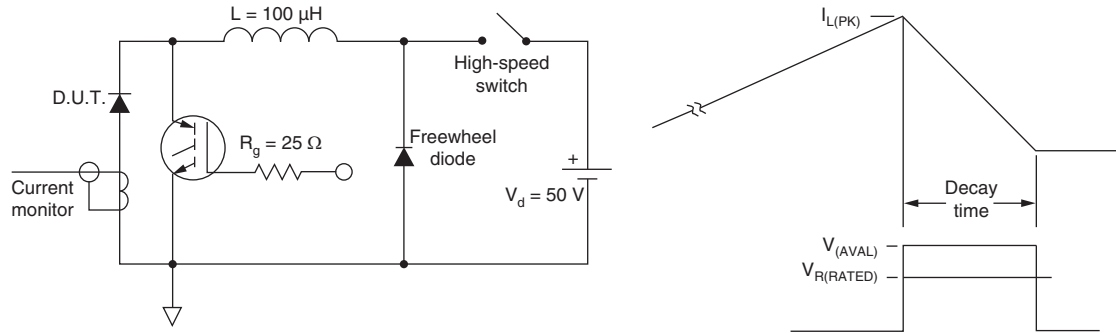

Fig. 12 - Avalanche Test Circuit and Waveforms

**ORDERING INFORMATION TABLE**

Device code	<b>VS-</b>	<b>HFA</b>	<b>135</b>	<b>N</b>	<b>H</b>	<b>40</b>	<b>PbF</b>
	①	②	③	④	⑤	⑥	⑦
	1	2	3	4	5	6	7

- 1 - Vishay Semiconductors product
- 2 - HEXFRED® family
- 3 - Average current rating
- 4 - N = Not isolated
- 5 - H = HALF-PAK
- 6 - Voltage rating (400 V)
- 7 - Lead (Pb)-free

**LINKS TO RELATED DOCUMENTS**

Dimensions	<a href="http://www.vishay.com/doc?95020">www.vishay.com/doc?95020</a>
------------	--

## D-67 HALF-PAK

**DIMENSIONS** in millimeters (inches)

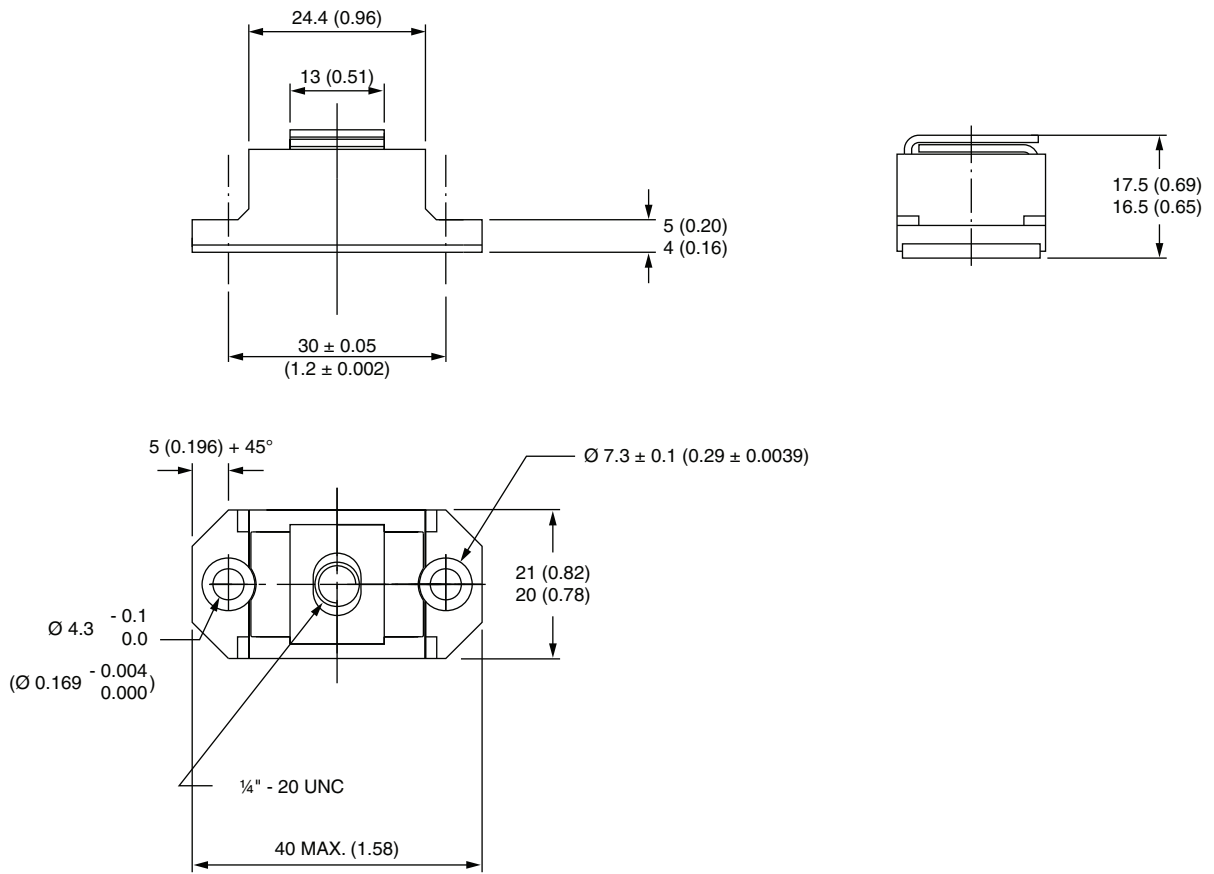



## Disclaimer

ALL PRODUCT, PRODUCT SPECIFICATIONS AND DATA ARE SUBJECT TO CHANGE WITHOUT NOTICE TO IMPROVE RELIABILITY, FUNCTION OR DESIGN OR OTHERWISE.

Vishay Intertechnology, Inc., its affiliates, agents, and employees, and all persons acting on its or their behalf (collectively, "Vishay"), disclaim any and all liability for any errors, inaccuracies or incompleteness contained in any datasheet or in any other disclosure relating to any product.

Vishay makes no warranty, representation or guarantee regarding the suitability of the products for any particular purpose or the continuing production of any product. To the maximum extent permitted by applicable law, Vishay disclaims (i) any and all liability arising out of the application or use of any product, (ii) any and all liability, including without limitation special, consequential or incidental damages, and (iii) any and all implied warranties, including warranties of fitness for particular purpose, non-infringement and merchantability.

Statements regarding the suitability of products for certain types of applications are based on Vishay's knowledge of typical requirements that are often placed on Vishay products in generic applications. Such statements are not binding statements about the suitability of products for a particular application. It is the customer's responsibility to validate that a particular product with the properties described in the product specification is suitable for use in a particular application. Parameters provided in datasheets and/or specifications may vary in different applications and performance may vary over time. All operating parameters, including typical parameters, must be validated for each customer application by the customer's technical experts. Product specifications do not expand or otherwise modify Vishay's terms and conditions of purchase, including but not limited to the warranty expressed therein.

Except as expressly indicated in writing, Vishay products are not designed for use in medical, life-saving, or life-sustaining applications or for any other application in which the failure of the Vishay product could result in personal injury or death. Customers using or selling Vishay products not expressly indicated for use in such applications do so at their own risk. Please contact authorized Vishay personnel to obtain written terms and conditions regarding products designed for such applications.

No license, express or implied, by estoppel or otherwise, to any intellectual property rights is granted by this document or by any conduct of Vishay. Product names and markings noted herein may be trademarks of their respective owners.

## Material Category Policy

**Vishay Intertechnology, Inc. hereby certifies that all its products that are identified as RoHS-Compliant fulfill the definitions and restrictions defined under Directive 2011/65/EU of The European Parliament and of the Council of June 8, 2011 on the restriction of the use of certain hazardous substances in electrical and electronic equipment (EEE) - recast, unless otherwise specified as non-compliant.**

**Please note that some Vishay documentation may still make reference to RoHS Directive 2002/95/EC. We confirm that all the products identified as being compliant to Directive 2002/95/EC conform to Directive 2011/65/EU.**

**Vishay Intertechnology, Inc. hereby certifies that all its products that are identified as Halogen-Free follow Halogen-Free requirements as per JEDEC JS709A standards. Please note that some Vishay documentation may still make reference to the IEC 61249-2-21 definition. We confirm that all the products identified as being compliant to IEC 61249-2-21 conform to JEDEC JS709A standards.**



Компания «ЭлектроПласт» предлагает заключение долгосрочных отношений при поставках импортных электронных компонентов на взаимовыгодных условиях!

Наши преимущества:

- Оперативные поставки широкого спектра электронных компонентов отечественного и импортного производства напрямую от производителей и с крупнейших мировых складов;
- Поставка более 17-ти миллионов наименований электронных компонентов;
- Поставка сложных, дефицитных, либо снятых с производства позиций;
- Оперативные сроки поставки под заказ (от 5 рабочих дней);
- Экспресс доставка в любую точку России;
- Техническая поддержка проекта, помощь в подборе аналогов, поставка прототипов;
- Система менеджмента качества сертифицирована по Международному стандарту ISO 9001;
- Лицензия ФСБ на осуществление работ с использованием сведений, составляющих государственную тайну;
- Поставка специализированных компонентов (Xilinx, Altera, Analog Devices, Intersil, Interpoint, Microsemi, Aeroflex, Peregrine, Syfer, Eurofarad, Texas Instrument, Miteq, Cobham, E2V, MA-COM, Hittite, Mini-Circuits, General Dynamics и др.);

Помимо этого, одним из направлений компании «ЭлектроПласт» является направление «Источники питания». Мы предлагаем Вам помощь Конструкторского отдела:

- Подбор оптимального решения, техническое обоснование при выборе компонента;
- Подбор аналогов;
- Консультации по применению компонента;
- Поставка образцов и прототипов;
- Техническая поддержка проекта;
- Защита от снятия компонента с производства.



#### Как с нами связаться

**Телефон:** 8 (812) 309 58 32 (многоканальный)

**Факс:** 8 (812) 320-02-42

**Электронная почта:** [org@eplast1.ru](mailto:org@eplast1.ru)

**Адрес:** 198099, г. Санкт-Петербург, ул. Калинина, дом 2, корпус 4, литера А.