

**SURFACE MOUNT
HIGH EFFICIENCY RECTIFIER**
VOLTAGE RANGE 50 to 1000 Volts CURRENT 1.0 Ampere

FEATURES

- * Low power loss, high efficiency
- * Low leakage
- * Low forward voltage
- * High current capability
- * High speed switching
- * High surge capability
- * High reliability

MECHANICAL DATA

- * Epoxy: Device has UL flammability classification 94V-0
- * Mounting position: Any
- * Weight: 0.018 gram

SOD-123F

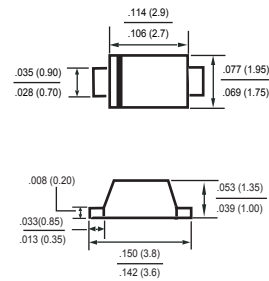

Dimensions in inches and (millimeters)

MAXIMUM RATINGS AND ELECTRICAL CHARACTERISTICS

Ratings at 25 °C ambient temperature unless otherwise specified.
Single phase, half wave, 60 Hz, resistive or inductive load.
For capacitive load, derate current by 20%.

MAXIMUM RATINGS (@ TA=25 °C unless otherwise noted)

RATINGS	SYMBOL	SH1	SH2	SH3	SH4	SH5	SH6	SH7	SH8	UNITS
Maximum Recurrent Peak Reverse Voltage	V _{RRM}	50	100	200	300	400	600	800	1000	Volts
Maximum RMS Voltage	V _{RMS}	35	70	140	210	280	420	420	700	Volts
Maximum DC Blocking Voltage	V _{DC}	50	100	200	300	400	600	600	1000	Volts
Maximum Average Forward Rectified Current at T _A = 55°C	I _O	1.0								Amps
Peak Forward Surge Current 8.3 ms single half sine-wave superimposed on rated load (JEDEC method)	I _{FSM}	30								Amps
Current Squared Time	I ² t	3.7								A ² /Sec
Typical Thermal Resistance (Note 1)	R _{θJA}	130								°C/W
Typical Thermal Resistance (Note 1)	R _{θJL}	30								°C/W
Typical Junction Capacitance (Note 2)	C _J	15						12		pF
Operating Temperature Range	T _J	-55 to + 150								°C
Storage Temperature Range	T _{STG}	-55 to + 150								°C

ELECTRICAL CHARACTERISTICS (@TA=25 °C unless otherwise noted)

CHARACTERISTICS	SYMBOL	SH1	SH2	SH3	SH4	SH5	SH6	SH7	SH8	UNITS	
Maximum Instantaneous Forward Voltage at 1.0A DC	V _F	1.0				1.3		1.7			Volts
Maximum Average Reverse Current at Rated DC Blocking Voltage	I _R	@ T _A = 25°C				5.0					uA
		@ T _A = 125°C				1.0					mA
Maximum Reverse Recovery Time (Note 4)	t _{rr}	50						75			nSec

- NOTES :
1. Thermal Resistance :Mounted on PCB.
 2. Measured at 1 MHz and applied reverse voltage of 4.0 volts.
 3. "ROHS compliant"
 4. Test Conditions: I_F= 0.5A, I_R= -1.0A, I_{RR}= -0.25A.
 5. Available in Halogen-free epoxy by adding suffix -HF after the part nbr.

2020-04
REV:B

RATING AND CHARACTERISTICS CURVES (SH1 THRU SH8)

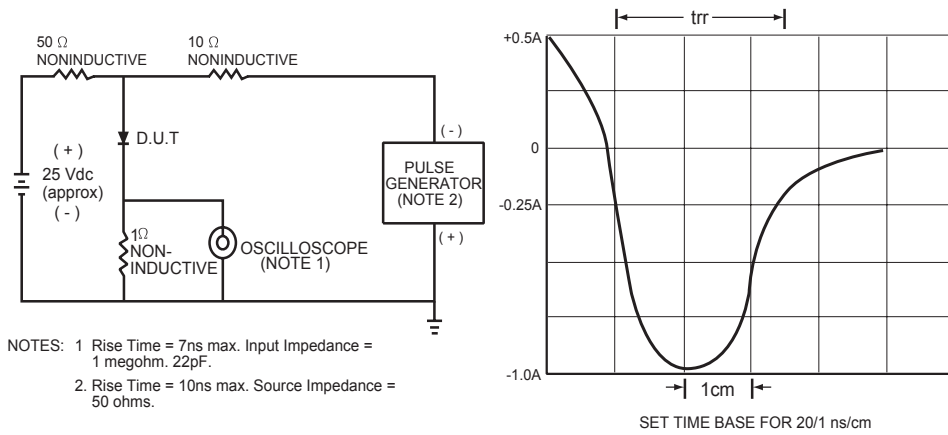

FIG.1 TEST CIRCUIT DIAGRAM AND REVERSE RECOVERY TIME CHARACTERISTIC

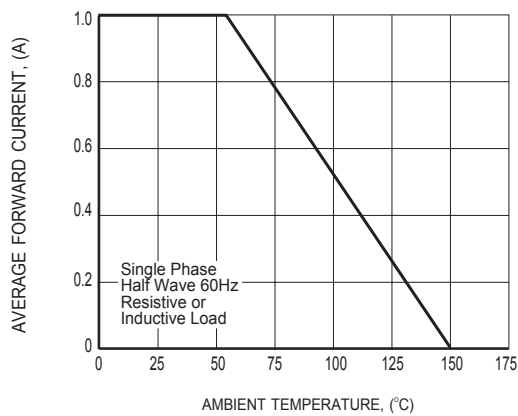

FIG.2 TYPICAL FORWARD CURRENT DERATING CURVE

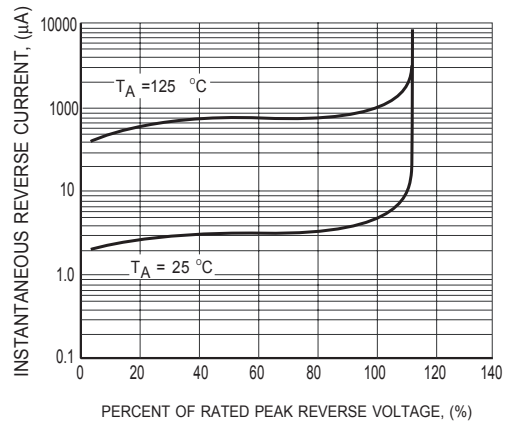

FIG.3 MAXIMUM REVERSE CHARACTERISTICS

RATING AND CHARACTERISTICS CURVES (SH1 THRU SH8)

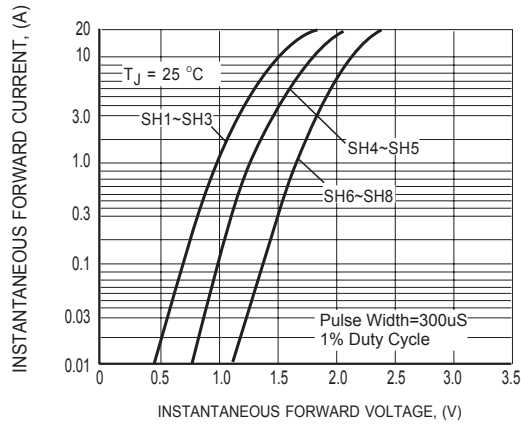

FIG.4 MAXIMUM INSTANTANEOUS FORWARD CHARACTERISTICS

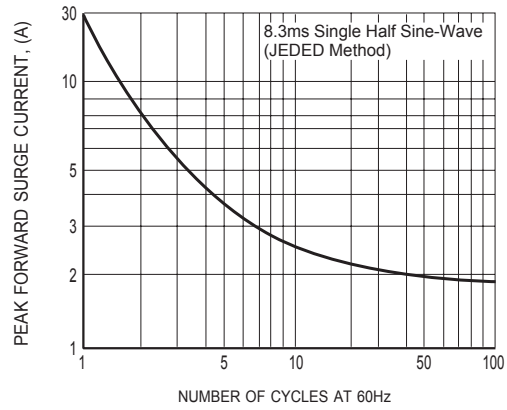

FIG.5 MAXIMUM NON-REPETITIVE FORWARD SURGE CURRENT

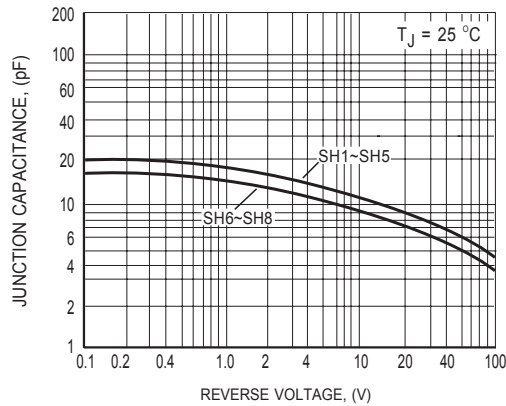
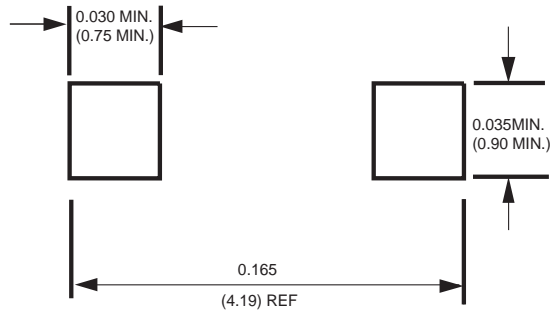

FIG.6 TYPICAL JUNCTION CAPACITANCE

Mounting Pad Layout



Dimensions in inches and (millimeters)

Marking Description

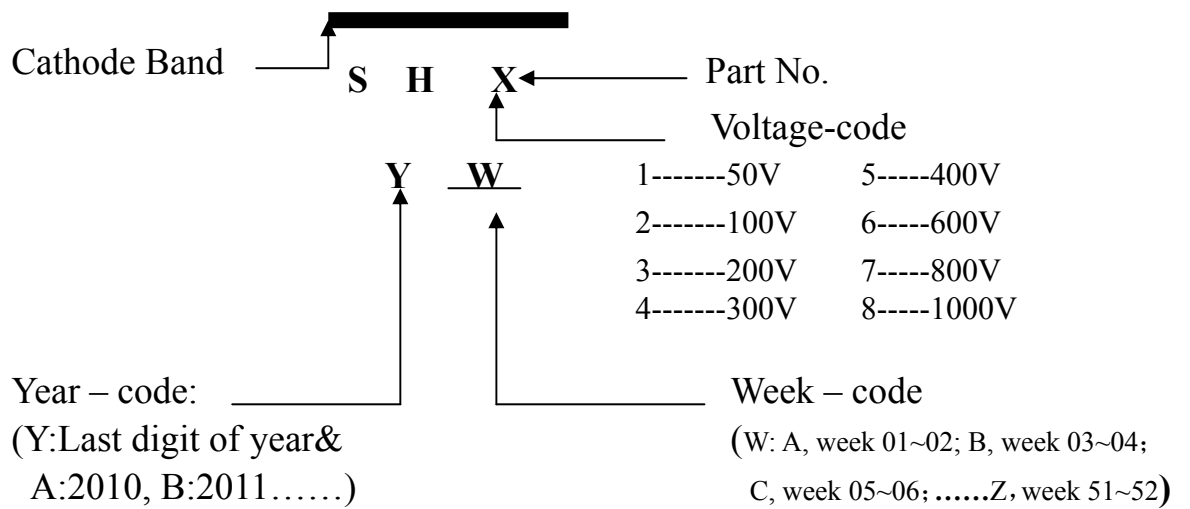

PACKAGING OF DIODE AND BRIDGE RECTIFIERS

REEL PACK

PACKAGE	PACKING CODE	EA PER REEL	EA PER INNER BOX	COMPONENT SPACE (mm)	TAPE SPACE (mm)	REEL DIA (mm)	CARTON SIZE (mm)	EA PER CARTON	GROSS WEIGHT(Kg)
SOD-123F/ SOD-123FL	-W	3,000	15,000	---	---	178	390*205*31	120,000	6.964

DISCLAIMER NOTICE

Rectron Inc reserves the right to make changes without notice to any product specification herein, to make corrections, modifications, enhancements or other changes. Rectron Inc or anyone on its behalf assumes no responsibility or liability for any errors or inaccuracies. Data sheet specifications and its information contained are intended to provide a product description only. "Typical" parameters which may be included on RECTRON data sheets and/ or specifications can and do vary in different applications and actual performance may vary over time. Rectron Inc does not assume any liability arising out of the application or use of any product or circuit.

Rectron products are not designed, intended or authorized for use in medical, life-saving implant or other applications intended for life-sustaining or other related applications where a failure or malfunction of component or circuitry may directly or indirectly cause injury or threaten a life without expressed written approval of Rectron Inc. Customers using or selling Rectron components for use in such applications do so at their own risk and shall agree to fully indemnify Rectron Inc and its subsidiaries harmless against all claims, damages and expenditures.



Компания «ЭлектроПласт» предлагает заключение долгосрочных отношений при поставках импортных электронных компонентов на взаимовыгодных условиях!

Наши преимущества:

- Оперативные поставки широкого спектра электронных компонентов отечественного и импортного производства напрямую от производителей и с крупнейших мировых складов;
- Поставка более 17-ти миллионов наименований электронных компонентов;
- Поставка сложных, дефицитных, либо снятых с производства позиций;
- Оперативные сроки поставки под заказ (от 5 рабочих дней);
- Экспресс доставка в любую точку России;
- Техническая поддержка проекта, помощь в подборе аналогов, поставка прототипов;
- Система менеджмента качества сертифицирована по Международному стандарту ISO 9001;
- Лицензия ФСБ на осуществление работ с использованием сведений, составляющих государственную тайну;
- Поставка специализированных компонентов (Xilinx, Altera, Analog Devices, Intersil, Interpoint, Microsemi, Aeroflex, Peregrine, Syfer, Eurofarad, Texas Instrument, Miteq, Cobham, E2V, MA-COM, Hittite, Mini-Circuits, General Dynamics и др.);

Помимо этого, одним из направлений компании «ЭлектроПласт» является направление «Источники питания». Мы предлагаем Вам помощь Конструкторского отдела:

- Подбор оптимального решения, техническое обоснование при выборе компонента;
- Подбор аналогов;
- Консультации по применению компонента;
- Поставка образцов и прототипов;
- Техническая поддержка проекта;
- Защита от снятия компонента с производства.



Как с нами связаться

Телефон: 8 (812) 309 58 32 (многоканальный)

Факс: 8 (812) 320-02-42

Электронная почта: org@eplast1.ru

Адрес: 198099, г. Санкт-Петербург, ул. Калинина, дом 2, корпус 4, литера А.