

High Performance IEC Inlet Filter



- Rated currents up to 20 A
- Optional medical versions (B type)
- Rear mounting
- Excellent attenuation in the lower frequency range



Performance indicators

Attenuation performance



Rated current [A]



Approvals



The FN 9246 IEC inlet filter combines an IEC inlet and mains filter with excellent filter attenuation in a small form factor. Choosing the FN 9246 product line brings you the rapid availability of a standard filter associated with the necessary safety acceptances. Standard IEC connector filters are a practical solution helping you to pass EMI system approval in a short time. A wide selection on current ratings and low leakage versions for medical applications are designed to offer you the desired solution.

Features and benefits

- Excellent conducted attenuation performance, based on chokes with high saturation resistance and excellent thermal behavior
- Rear mounting
- Optional low leakage current versions for medical applications
- Rated currents up to 20 A
- Custom-specific versions are available on request

Technical specifications

Maximum continuous operating voltage	250 VAC, 50/60 Hz
Operating frequency	DC to 400 Hz
Rated currents	1 to 20 A @ 50°C
Approvals by rated current	1 to 10 A (Semko) 16 A (Semko) for 16 and 20 A types 1 to 20 A (UL, CSA)
High potential test voltage	P → PE 2000 VAC for 2 sec (standard types) P → PE 2500 VAC for 2 sec (B types) P → N 1100 VAC for 2 sec (1 to 10 A types) P → N 1100 VDC for 2 sec (16 and 20 A types)
Protection category	IP 40 according to IEC 60529
Temperature range (operation and storage)	-25°C to +85°C (25/85/21)
Design corresponding to	UL 1283, CSA 22.2 No. 8 1986, IEC/EN 60939
Flammability corresponding to	UL 94 V-2 or better
MTBF @ 40°C/230 V (Mil-HB-217F)	1,600,000 hours

Typical applications

- Electrical and electronic equipment
- Small to medium-sized machines and household equipment
- Single-phase power supplies, switch-mode power supplies
- Test and measurement equipment
- Building automation
- Medical equipment
- Lighting application

Typical electrical schematic

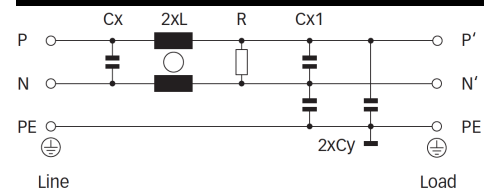

Filter selection table

Filter	Rated current @ 40°C (25°C) [A]	Leakage current* @ 250 VAC/50 Hz (@ 120 VAC/60 Hz) [mA]	Inductance L [mH]	Capacitance		Resistance R [kΩ]	Output connections 	Weight [g]
				Cx [μF]	Cy [nF]			
FN 9246-1-06	1 (1.2)	0.31 (0.18)	50	1.22	2.2	470	-06	140
FN 9246-3-06	3 (3.5)	0.31 (0.18)	14	1.22	2.2	470	-06	140
FN 9246-6-06	6 (7.2)	0.31 (0.18)	7	1.22	2.2	470	-06	140
FN 9246-10-06	10 (12)	0.31 (0.18)	3	1.22	2.2	470	-06	140
FN 9246-12-06	12 (14)	0.31 (0.18)	1.85	1.22	2.2	470	-06	140
FN 9246-15-06	15 (18)	0.31 (0.18)	0.89	1.22	2.2	470	-06	140
FN 9246-16-06	16 (18.5)	0.66 (0.38)	2.5	1.22	4.7	470	-06	275
FN 9246-20-06	20 (23)	0.66 (0.38)	1.5	1.22	4.7	470	-06	275
FN 9246 B-1-06	1 (1.2)	0.00	50	1.22		470	-06	140
FN 9246 B-3-06	3 (3.5)	0.00	14	1.22		470	-06	140
FN 9246 B-6-06	6 (7.2)	0.00	7	1.22		470	-06	140
FN 9246 B-10-06	10 (11.6)	0.00	3	1.22		470	-06	140
FN 9246 B-12-06	12 (14)	0.00	1.85	1.22		470	-06	140
FN 9246 B-15-06	15 (18)	0.00	0.89	1.22		470	-06	140
FN 9246 B-16-06	16 (18.5)	0.00	2.5	1.22		470	-06	275
FN 9246 B-20-06	20 (23)	0.00	1.5	1.22		470	-06	275

* Maximum leakage under normal operating conditions (acc. to IEC60939-3). Note: if the neutral line is interrupted, worst case leakage could reach twice this level.

Typical filter attenuation

Per CISPR 17; A=50 Ω/50 Ω sym; B=50 Ω/50 Ω asym; C=0.1 Ω/100 Ω sym; D=100 Ω/0.1 Ω sym

1 A types

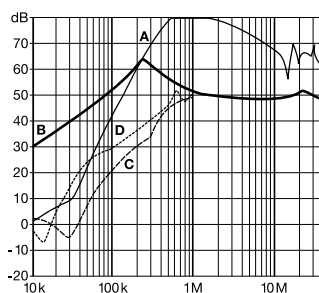

3 to 10 A types

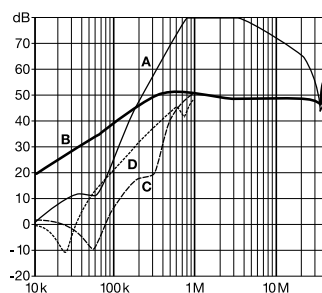

12 and 15 A types

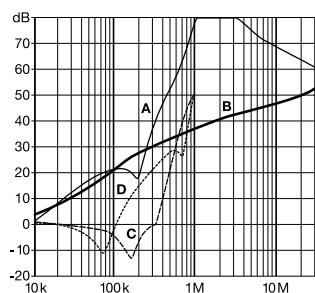

16 and 20 A types

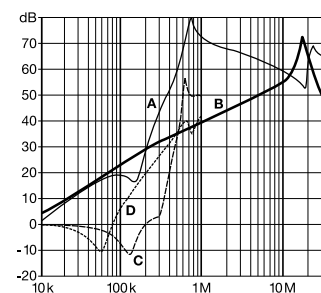

Product selector

FN 9246x-yy--

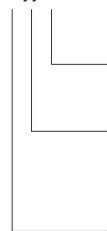

- 06: Faston 6.3 x 0.8mm (spade/soldering)
- 1 to 20: Rated current
Standard IEC inlet type C14 (1 to 15A types), C20 (16 and 20A types)
- Blank: Standard version
- B: Medical version (with bleed resistor and without Y2-capacitor)

For example: FN 9246-6-06, FN 9246 B-10-06

Mechanical data

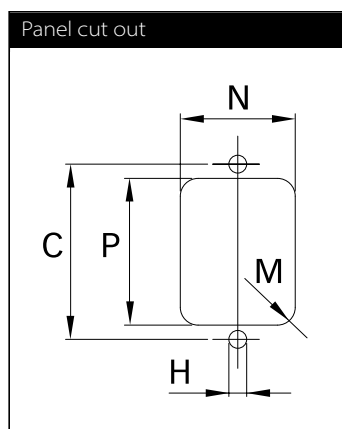
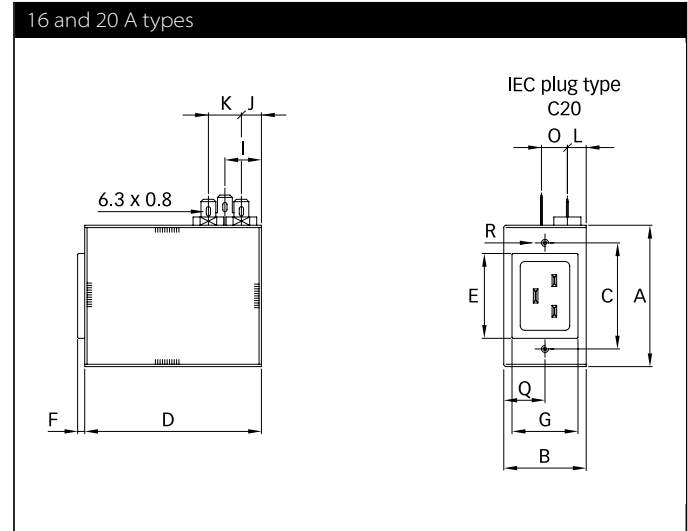
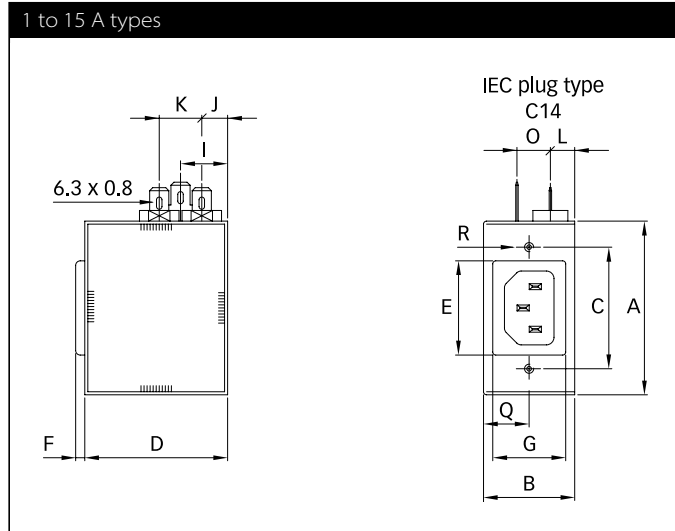

	1 A	3 A	6 A	10 A	12 A	15 A	16 A	20 A
A	57.15	57.15	57.15	57.15	57.15	57.15	60	60
B	30	30	30	30	30	30	35	35
C	40	40	40	40	40	40	45	45
D	47	47	47	47	47	47	75	75
E	31	31	31	31	31	31	36	36
F	3	3	3	3	3	3	3	3
G	24	24	24	24	24	24	28	28
H	Ø3.5	Ø3.5	Ø3.5	Ø3.5	Ø3.5	Ø3.5	Ø3.5	Ø3.5
I	15.5	15.5	15.5	15.5	15.5	15.5	15.5	15.5
J	8.5	8.5	8.5	8.5	8.5	8.5	8.5	8.5
K	14	14	14	14	14	14	14	14
L	8	8	8	8	8	8	8	8
M	R ≤ 1.5	R ≤ 1.5	R ≤ 1.5	R ≤ 1.5	R ≤ 1.5	R ≤ 1.5	R ≤ 1.5	R ≤ 1.5
N	25	25	25	25	25	25	29	29
O	11	11	11	11	11	11	11	11
P	32	32	32	32	32	32	37	37
Q	15	15	15	15	15	15	17.5	17.5
R				M3 x 10 max.				

All dimensions in mm; 1 inch = 25.4 mm
Tolerances according: ISO 2768-m/EN 22768-m



Headquarters, global innovation and development

Switzerland

Schaffner Group

Nordstrasse 11
4542 Luterbach
T +41 32 681 66 26
info@schaffner.com
www.schaffner.com



Sales and application centers

China

Schaffner EMC Ltd. Shanghai

T20-3 C, No 565 Chuangye Road,
Pudong district
201201 Shanghai
T +86 21 3813 9500
cschina@schaffner.com
www.schaffner.com.cn

Finland

Schaffner Oy

Sauvonrinne 19 H
08500 Lohja
T +358 50 468 7284
finlandsales@schaffner.com

France

Schaffner EMC S.A.S.

16-20 Rue Louis Rameau
95875 Bezons
T +33 1 34 34 30 60
F +33 1 39 47 02 28
francesales@schaffner.com

Germany

Schaffner Deutschland GmbH

Schoemperlenstrasse 12B
76185 Karlsruhe
T +49 721 56910
F +49 721 569110
germanysales@schaffner.com

India

Schaffner India Pvt. Ltd

REGUS WORLD TRADE CENTRE
WTC, 22nd Floor Unit No 2238, Brigade
Gateway Campus, 26/1, Dr. Rajkumar Road
Malleswaram (W)
560055 Bangalore
T +91 80 67935355
indiasales@schaffner.com

Italy

Schaffner EMC S.r.l.

Via Ticino, 30
20900 Monza (MB)
T +39 039 21 41 070
italysales@schaffner.com

Japan

Schaffner EMC K.K.

1-32-12, Kamiyama, Setagaya-ku
7F Mitsui-seimei Sangenjaya Bldg.
154-0011 Tokyo
T +81 3 5712 3650
F +81 3 5712 3651
japansales@schaffner.com
www.schaffner.jp

Singapore

Schaffner EMC Pte Ltd.

#05-09, Kg Ubi Ind. Estate
408705 Singapore
T +65 6377 3283
F +65 6377 3281
singaporesales@schaffner.com

Spain

Schaffner EMC España

Calle Caléndula 93, Miniparc III, Edificio E
El Soto de Moraleja, Alcobendas
28109 Madrid
T +34 917 912 900
F +34 917 912 901
spainsales@schaffner.com

Sweden

Schaffner EMC AB

Tegeluddsvägen 76, 2tr
115 28 Stockholm
T +46 8 5050 2425
swedensales@schaffner.com
www.schaffner.com

Switzerland

Schaffner EMV AG

Nordstrasse 11
4542 Luterbach
T +41 32 681 66 26
switzerlandsales@schaffner.com

Taiwan R.O.C.

Schaffner EMV Ltd.

20 Floor-2, No 97, Section 1, XinTai 5th Road
22175 XiZhi District New Taipei City 22175
T +886 2 2697 5500
F +886 2 2697 5533
taiwansales@schaffner.com
www.schaffner.com.tw

Thailand

Schaffner EMC Co. Ltd.

Northern Region Industrial Estate
67 Moo 4 Tambon Ban Klang
Amphur Muangng P.O. Box 14
51000 Lamphun
T +66 53 58 11 04
F +66 53 58 10 19
thailandsales@schaffner.com

United Kingdom

Schaffner Ltd.

5 Ashville Way, Molly Millars Lane
Wokingham
RG41 2PL Berkshire
T +44 118 9770070
F +44 118 9792969
uksales@schaffner.com

USA

Schaffner EMC Inc.

52 Mayfield Avenue
08837 Edison, New Jersey
T +1 800 367 5566
T +1 732 225 9533
F +1 732 225 4789
usasales@schaffner.com
www.schaffnerusa.com

Schaffner North America

6722 Thirlane Road
24019 Roanoke, Virginia
T +1 276 228 7943
F +1 276 228 7953

Schaffner North America

823 Fairview Road
24382 Wytheville, Virginia
T +1 276 228 7943
F +1 276 228 7258

To find your local partner within Schaffner's global network: www.schaffner.com

© 2018 Schaffner Group

The content of this document has been carefully checked and understood. However, neither Schaffner nor its subsidiaries assume any liability whatsoever for any errors or inaccuracies of this document and the consequences thereof. Published specifications are subject to change without notice. Product suitability for any area of application must ultimately be determined by the customer. In all cases, products must never be operated outside their published specifications. Schaffner does not guarantee the availability of all published products. This disclaimer shall be governed by substantive Swiss law and resulting disputes shall be settled by the courts at the place of business of Schaffner Holding AG. Latest publications and a complete disclaimer can be downloaded from the Schaffner website. All trademarks recognized.



Компания «ЭлектроПласт» предлагает заключение долгосрочных отношений при поставках импортных электронных компонентов на взаимовыгодных условиях!

Наши преимущества:

- Оперативные поставки широкого спектра электронных компонентов отечественного и импортного производства напрямую от производителей и с крупнейших мировых складов;
- Поставка более 17-ти миллионов наименований электронных компонентов;
- Поставка сложных, дефицитных, либо снятых с производства позиций;
- Оперативные сроки поставки под заказ (от 5 рабочих дней);
- Экспресс доставка в любую точку России;
- Техническая поддержка проекта, помощь в подборе аналогов, поставка прототипов;
- Система менеджмента качества сертифицирована по Международному стандарту ISO 9001;
- Лицензия ФСБ на осуществление работ с использованием сведений, составляющих государственную тайну;
- Поставка специализированных компонентов (Xilinx, Altera, Analog Devices, Intersil, Interpoint, Microsemi, Aeroflex, Peregrine, Syfer, Eurofarad, Texas Instrument, Miteq, Cobham, E2V, MA-COM, Hittite, Mini-Circuits, General Dynamics и др.);

Помимо этого, одним из направлений компании «ЭлектроПласт» является направление «Источники питания». Мы предлагаем Вам помощь Конструкторского отдела:

- Подбор оптимального решения, техническое обоснование при выборе компонента;
- Подбор аналогов;
- Консультации по применению компонента;
- Поставка образцов и прототипов;
- Техническая поддержка проекта;
- Защита от снятия компонента с производства.



Как с нами связаться

Телефон: 8 (812) 309 58 32 (многоканальный)

Факс: 8 (812) 320-02-42

Электронная почта: org@eplast1.ru

Адрес: 198099, г. Санкт-Петербург, ул. Калинина, дом 2, корпус 4, литера А.