

SERIES D16, P16, L16 SWITCHES

PUSHBUTTON SWITCHES - ILLUMINATED

TACT SWITCHES

NAVIGATION SWITCHES

PUSHBUTTON SWITCHES

TOGGLE SWITCHES

ROCKER SWITCHES

SLIDE SWITCHES

SNAP-ACTION SWITCHES

DIP SWITCHES

KEYLOCK SWITCHES

ROTARY SWITCHES

DETECTOR SWITCHES

CAP OPTIONS



SPECIFICATIONS

Contact Rating:	5A@250 VAC-UL, VDE 8A@125 VAC - UL, CSA 6A@24 VDC - UL, CSA
Life Expectancy (Mechanical):	100,000 cycles
Life Expectancy (Electrical):	50,000 cycles
Contact Resistance:	100mΩ max. typical; initial @ 2-4 VDC
Insulation Resistance:	> 1,000MΩ
Dielectric Strength:	> 1,500 volts 1 minute > 3,000 volts between poles
Actuation Force:	300g/pole
Operating Temperature:	-20°C to 55°C

FEATURES & BENEFITS

- ▶ Modular interface/contact block design
- ▶ Robust product for industrial applications
- ▶ Attractive front panel design
- ▶ Illuminated options available

APPLICATIONS/MARKETS

- ▶ Industrial controls
- ▶ Instrumentation
- ▶ Transportation
- ▶ Telecommunications

MATERIALS

Switch Housing:	Polyetherimide (PEI)
Contact Housing:	Diallyl Phthalate (DAP)
Lens:	Polycarbonate (PC)
Contacts:	Silver plated copper alloy
Terminals:	Silver plated copper alloy

HOW TO ORDER

SERIES	MECHANICAL CONFIGURATION	PUSHBUTTON HEAD	CIRCUIT	LAMP TYPE & VOLTAGE	LAMP COLOR (WHERE APPLICABLE)	LENS COLOR
D16 = Solder Lug P16 = Socket L16 = Pilot Indicator	EE = Latching OA = Momentary PL* = Pilot Indicator *For L16 (Pilot Indicator)	S1 S2 T1 T2 R* R1 *R (Mushroom Head) Available for D16 & P16 Only.	0* = Pilot Ind. 1**= SPDT 2 = DPDT 3 = 3PDT 4 = 4PDT *For L16 only (Pilot Indicator) **P16 available SPDT only	0 = None A B C F G H J K M N L D E	F Red G Grn H Red J Grn K Yel	RED= Red GRN= Green BLU= Blue* WHT= White* ORG= Orange* YEL= Yellow* *Not Available For 'R' Mushroom Head.

▶ ▶ ▶ **Example Ordering Number**
D16-EE-R1-3-A-BLU

Specifications subject to change without notice.



SERIES D16 SWITCHES

PUSHBUTTON SWITCHES - ILLUMINATED

D16 (SOLDER LUG)

R

MUSHROOM

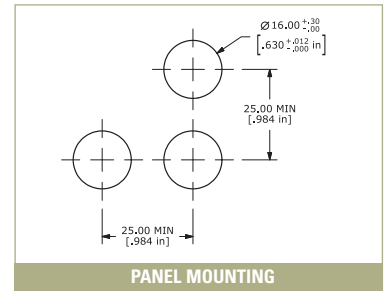
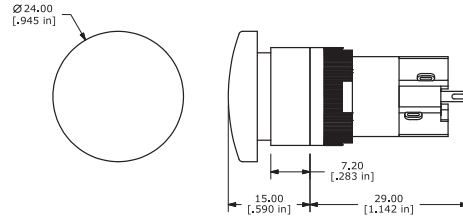

D16 (SOLDER LUG)

R1

ROUND

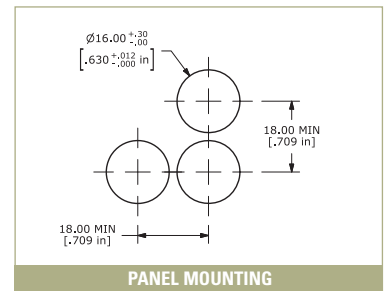
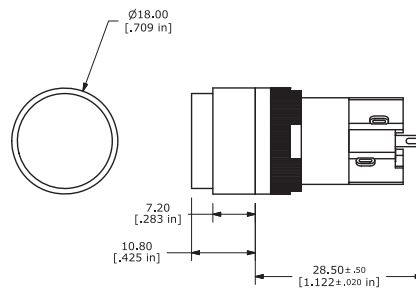

D16 (SOLDER LUG)

S1

SQUARE

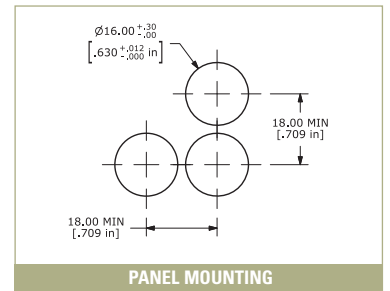
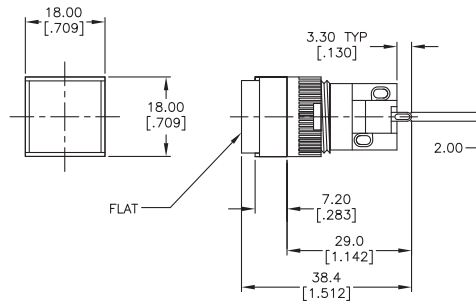

D16 (SOLDER LUG)

T1

RECTANGULAR

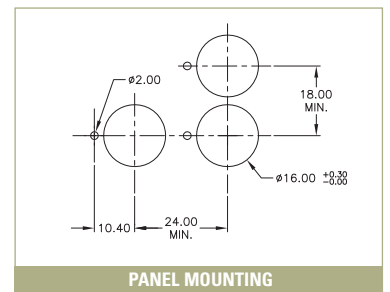
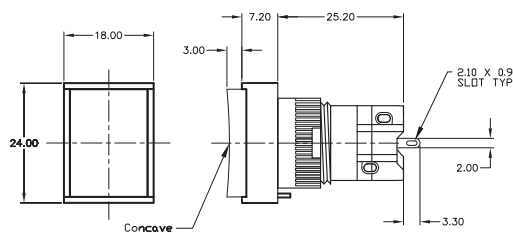

BOTTOM VIEW

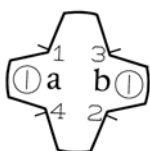

SCHEMATIC

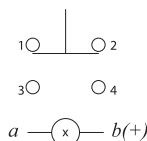

MOUNTING LENGTH

	Mounting Length (A)
SPDT	29.0 mm
DPDT	36.5 mm
3PDT	44.0 mm
4PDT	51.5 mm

SERIES P16 SWITCHES

PUSHBUTTON SWITCHES - ILLUMINATED

TACT SWITCHES

NAVIGATION SWITCHES

PUSHBUTTON SWITCHES

TOGGLE SWITCHES

ROCKER SWITCHES

SLIDE SWITCHES

SNAP-ACTION SWITCHES

DIP SWITCHES

KEYLOCK SWITCHES

ROTARY SWITCHES

DETECTOR SWITCHES

CAP OPTIONS

P16 (SOCKET)

R

MUSHROOM

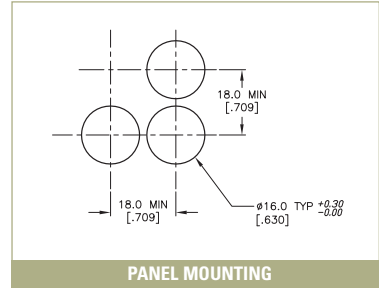
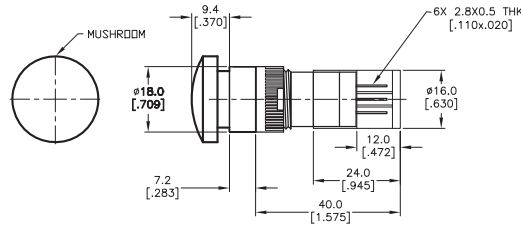

PANEL MOUNTING

P16 (SOCKET)

R1

ROUND

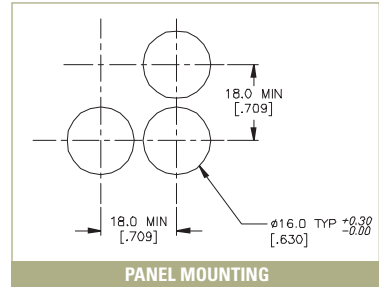
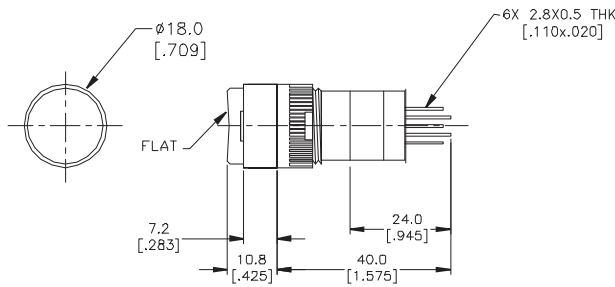

PANEL MOUNTING

P16 (SOCKET)

S1

SQUARE

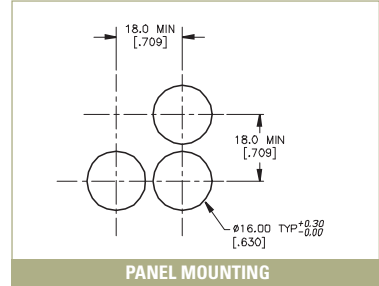
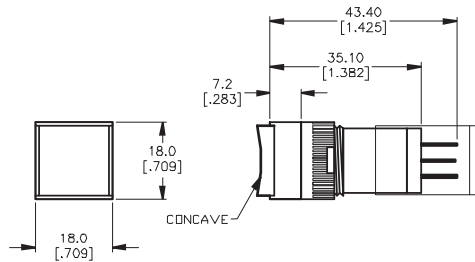

PANEL MOUNTING

P16 (SOCKET)

T1

RECTANGULAR

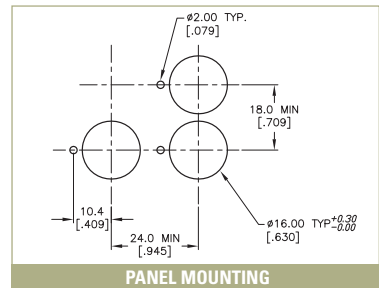
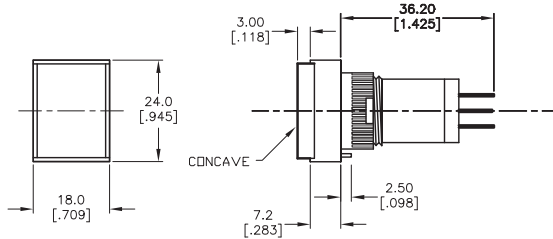

PANEL MOUNTING

BOTTOM VIEW

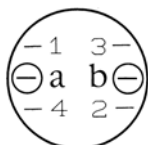

SCHEMATIC

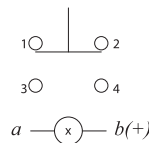



SERIES L16 SWITCHES

PUSHBUTTON SWITCHES - ILLUMINATED

L16 (PILOT INDICATOR)

R1

ROUND

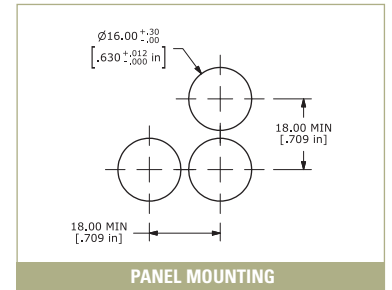
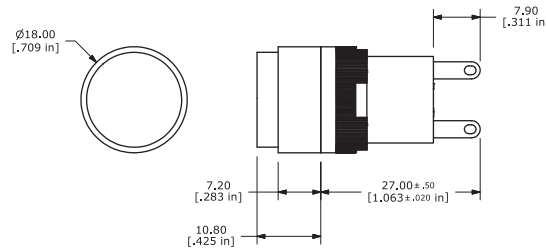

PANEL MOUNTING

L16 (PILOT INDICATOR)

S1

SQUARE

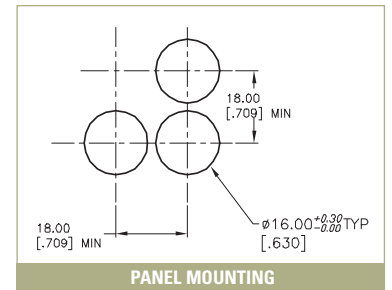
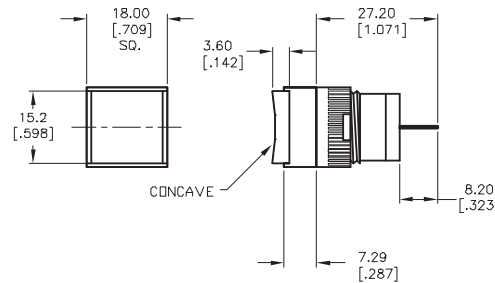

PANEL MOUNTING

L16 (PILOT INDICATOR)

T1

RECTANGULAR

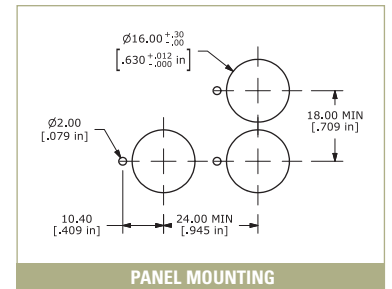
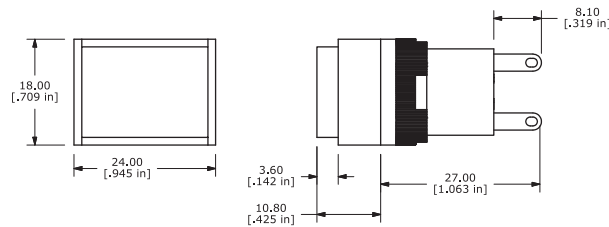

PANEL MOUNTING

BOTTOM VIEW

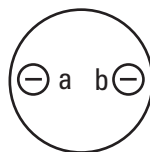

SCHEMATIC

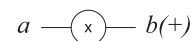

SERIES D16, P16, L16 SWITCHES

PUSHBUTTON SWITCHES - ILLUMINATED

TACT SWITCHES

NAVIGATION SWITCHES

PUSHBUTTON SWITCHES

TOGGLE SWITCHES

ROCKER SWITCHES

SLIDE SWITCHES

SNAP-ACTION SWITCHES

DIP SWITCHES

KEYLOCK SWITCHES

ROTARY SWITCHES

DETECTOR SWITCHES

CAP OPTIONS

MECHANICAL CONFIGURATION & CIRCUIT OPTIONS

0 PILOT INDICATOR

Available 'L16' Pilot Indicator Type



SCHEMATIC

1 SPDT**

Available for 'P16' Socket Type and 'D16' Solder Lug

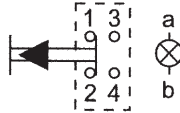

SCHEMATIC

2 DPDT

Available for 'D16' Solder Lug

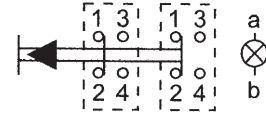

SCHEMATIC

3 3PDT

Available for 'D16' Solder Lug

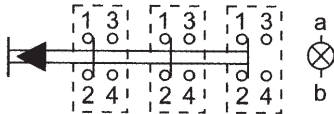

SCHEMATIC

4 4PDT

Available for 'D16' Solder Lug

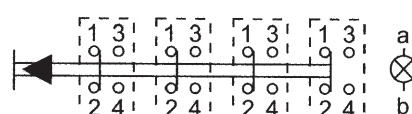

SCHEMATIC

Mechanical Configuration Code

EE	Latching
OA	Momentary
PL	Pilot Indicator*

*L16' Series only

LAMP TYPE & VOLTAGE OPTIONS

ILLUSTRATION	CATEGORY	DESCRIPTION	COLOR	PART NO.
	Incandescent	A = 6V AC/DC 200 mA	Not Applicable	50-004-02
		B = 14V AC/DC 80 mA		50-004-04
		C = 28V AC/DC 40 mA		50-004-05
		D = 48V AC/DC 25 mA		50-004-06
		E = 60V AC/DC 20 mA		50-004-07
		L = 33V AC/DC 35 mA		50-004-08
		N = 14V AC/DC 40 mA		50-004-03
M = 6V AC/DC 40 mA	50-004-01			
	Neon	F = 110V AC	green	50-004-11
			red	50-004-12
		G = 220V AC	green	50-004-13
			red	50-004-14
	LED	H = 6V DC	green	50-004-16
			red	50-004-17
			yellow	50-004-18
		J = 12V DC	green	50-004-19
			red	50-004-20
			yellow	50-004-21
K = 24V DC	green	50-004-22		
	red	50-004-23		
	yellow	50-004-24		



ILLUSTRATION		STYLE	SHAPE	COLOR	PART NO.
	Available Color Lens (Acrylic Resin)	Round	Concave	blue green orange red white yellow	50-001-01 50-001-02 50-001-03 50-001-04 50-001-05 50-001-06
		Rectangular	Concave	blue green orange red white yellow	50-002-01 50-002-02 50-002-03 50-002-04 50-002-05 50-002-06
		Square	Concave	blue green orange red white yellow	50-003-01 50-003-02 50-003-03 50-003-04 50-003-05 50-003-06
		Mushroom Head	Convex	green red	50-012-01 50-012-02
		Round	Flat	blue green orange red white yellow	50-001-11 50-001-12 50-001-13 50-001-14 50-001-15 50-001-16
		Rectangular	Flat	blue green orange red white yellow	50-002-11 50-002-12 50-002-13 50-002-14 50-002-15 50-002-16
		Square	Flat	blue green orange red white yellow	50-003-11 50-003-12 50-003-13 50-003-14 50-003-15 50-003-16

TACT SWITCHES

NAVIGATION SWITCHES

PUSHBUTTON SWITCHES

TOGGLE SWITCHES

ROCKER SWITCHES

SLIDE SWITCHES

SNAP-ACTION SWITCHES

DIP SWITCHES

KEYLOCK SWITCHES

ROTARY SWITCHES

DETECTOR SWITCHES

CAP OPTIONS

SERIES D16, P16, L16 SWITCHES

PUSHBUTTON SWITCHES - ILLUMINATED

TACT SWITCHES

NAVIGATION SWITCHES

PUSHBUTTON SWITCHES

TOGGLE SWITCHES

ROCKER SWITCHES

SLIDE SWITCHES

SNAP-ACTION SWITCHES









DIP SWITCHES

KEYLOCK SWITCHES

ROTARY SWITCHES

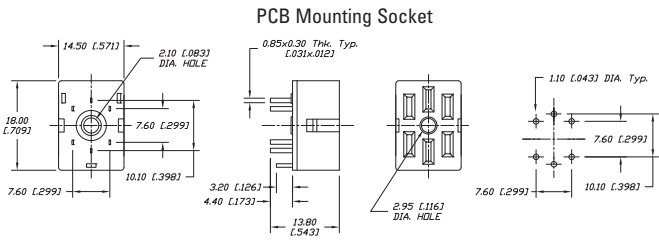
DETECTOR SWITCHES

CAP OPTIONS

ILLUSTRATION	CATEGORY	DESCRIPTION	PART NO.
	Lamp Extractor * Also available for LA Series	Lamp removing tool	50-005-01
	Blanking Plate Block	PVC stopper to stuff the superfluous hole of the panel board	50-013-01
	Connector * Also available for LA Series	Insulation Socket 2.8 x 0.5 mm	50-014-01
	PCB Mounting Socket		50-015-01
	Mounting Wrench * Also available for LA Series	Use this for tightening the switch in the mounting hole	50-006-01
	Lens Removing Tool	Use this for replacing the fitted color lens	50-007-01
	Spray Cover	Meets requirement of IP65, two pieces of transparent plastic, rectangular head	50-010-01
	Protection Cap	To avoid faulty operation, housing for locking, transparent For square head (90°) For square head (180°) For rectangular head (90°) For rectangular head (180°)	50-011-01 50-011-11 50-011-02 50-011-12



Компания «ЭлектроПласт» предлагает заключение долгосрочных отношений при поставках импортных электронных компонентов на взаимовыгодных условиях!

Наши преимущества:

- Оперативные поставки широкого спектра электронных компонентов отечественного и импортного производства напрямую от производителей и с крупнейших мировых складов;
- Поставка более 17-ти миллионов наименований электронных компонентов;
- Поставка сложных, дефицитных, либо снятых с производства позиций;
- Оперативные сроки поставки под заказ (от 5 рабочих дней);
- Экспресс доставка в любую точку России;
- Техническая поддержка проекта, помощь в подборе аналогов, поставка прототипов;
- Система менеджмента качества сертифицирована по Международному стандарту ISO 9001;
- Лицензия ФСБ на осуществление работ с использованием сведений, составляющих государственную тайну;
- Поставка специализированных компонентов (Xilinx, Altera, Analog Devices, Intersil, Interpoint, Microsemi, Aeroflex, Peregrine, Syfer, Eurofarad, Texas Instrument, Miteq, Cobham, E2V, MA-COM, Hittite, Mini-Circuits, General Dynamics и др.);

Помимо этого, одним из направлений компании «ЭлектроПласт» является направление «Источники питания». Мы предлагаем Вам помощь Конструкторского отдела:

- Подбор оптимального решения, техническое обоснование при выборе компонента;
- Подбор аналогов;
- Консультации по применению компонента;
- Поставка образцов и прототипов;
- Техническая поддержка проекта;
- Защита от снятия компонента с производства.



Как с нами связаться

Телефон: 8 (812) 309 58 32 (многоканальный)

Факс: 8 (812) 320-02-42

Электронная почта: org@eplast1.ru

Адрес: 198099, г. Санкт-Петербург, ул. Калинина, дом 2, корпус 4, литера А.