

Keywords: Fresno, MAXREFDES11, subsystem reference design, analog front end, AFE, industrial sensors, isolated power and data, industrial automation, PLC, medical

REFERENCE DESIGN 5563 INCLUDES: ✓Tested Circuit ✓Schematic ✓BOM ✓Board Available ✓Description ✓Test Data ✓Layout
Fresno (MAXREFDES11#): 16-Bit High-Accuracy 0 to 10V Input Isolated Analog Front End (AFE)

Jan 19, 2013

Abstract: This document explains how the Fresno (MAXREFDES11#) subsystem reference design meets the higher resolution and higher voltage needs of industrial control and industrial automation applications. Hardware and firmware design files as well as FFTs and histograms from lab measurements are provided.

Introduction

Low resolution and low input voltage analog-to-digital converters (ADCs) are integrated in many of today's field programmable gate arrays (FPGAs) and microcontrollers. However, they fall short on meeting the needs of industrial control and industrial automation applications that require higher resolutions and higher input voltages. The Fresno (MAXREFDES11#) subsystem reference design is a 16-bit high-accuracy industrial analog front end (AFE) that accepts 0 to 10V signals and features isolated power and data—all integrated into a small form factor. The Fresno design integrates an ultra-precision low-noise buffer (MAX44250); a highly accurate ADC (MAX11100); an ultra-high-precision 4.096V voltage reference (MAX6126); 600V_{RMS} data isolation (MAX14850); and isolated/regulated +5.5V, +5V, and -3V power rails (MAX256/MAX1659/MAX1735). This AFE solution can be used in any application that needs high-accuracy analog-to-digital conversion, but it is mainly targeted for industrial sensors, industrial automation, process control, programmable logic controllers (PLCs), and medical applications.

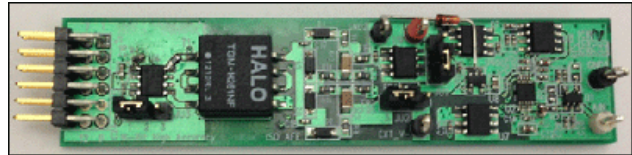

[More detailed image \(JPG\)](#)

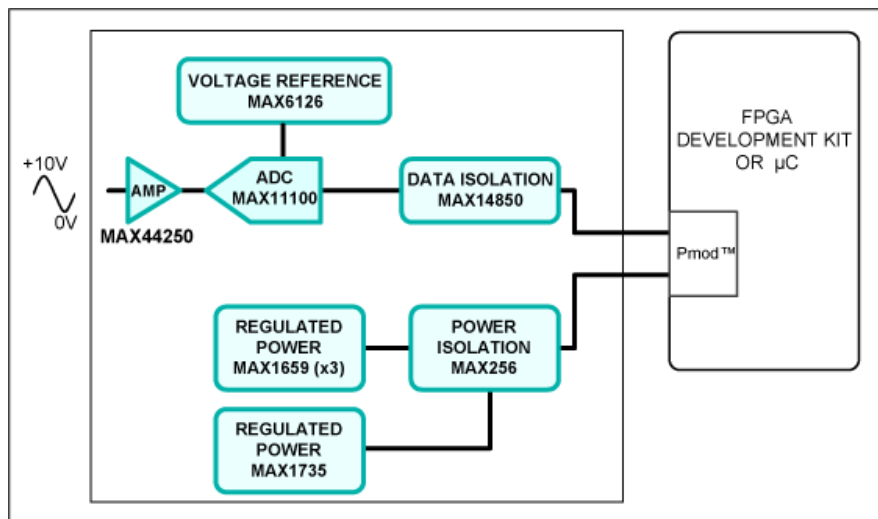

Figure 1. The Fresno subsystem design block diagram.

Features

- High accuracy
- 0 to 10V input range
- Isolated power and data
- Small PCB area
- Pmod™-compatible form factor
- Industrial sensors
- Process control
- Industrial automation
- PLC
- Medical

Applications

Detailed Description of Hardware

The Pmod specification allows for both 3.3V and 5V modules as well as various pin assignments. This module is designed only for a supply voltage of 3.3V and uses the SPI pin assignments as illustrated on the right.

The power requirements are shown in **Table 1**. The currently supported platforms and ports are shown in **Table 2**.

Power Type	Jumper Shunt	Input Voltage (V)	Input Current (mA, typ)
On-board isolated power	JU1: 1–2	3.3	71
	JU2: 2–3		
	JU3: 1–2		
External power	JU1: 2–3	6	10
	JU2: 1–2	-5	2
	JU3: 2–3		

Supported Platforms	Port
Nexys™ 3 platform (Spartan®-6)	JB1

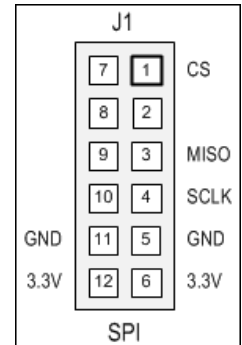

The Fresno hardware design provides isolated power (MAX256) and isolated data (MAX14850) for a high-accuracy, 0 to 10V signal, analog-to-digital conversion application.

The MAX44250 (U1) op amp input circuit attenuates and buffers a 0 to 10V signal to match the input range of the ADC (MAX11100), which is 0 to 4.096V.

The MAX11100 (U2) is a 16-bit, successive-approximation register (SAR) ADC with AutoShutdown™ and fast 1.1µs wake-up features. The ADC's reference input is driven by an ultra-high-precision 4.096V voltage reference, the MAX6126 (U3), with 0.02% initial accuracy and a 3ppm/°C maximum temperature coefficient (tempco).

The MAX256 (U4) provides an isolated, functional insulation class power solution that accepts 3.3V and converts it to ±6V using an off-the-shelf TGN-H251NF Halo® transformer with a 1:1 primary to secondary turns ratio plus an external on-board voltage-doubler circuit. Post-regulation is accomplished using the MAX1659 low dropout (LDO) regulator (for +5V) and the MAX1735 low dropout (LDO) regulator (for -3V). Data isolation is accomplished using the MAX14850 (U5) digital data isolator. The combined power and data isolation achieved is 600V_{RMS}.

The signal input impedance of the Fresno subsystem is 5kΩ (R19 + R20). Ideally, the input impedance should be high, but larger resistors induce higher thermal noise and degrade the noise performance. Therefore, the values of the input resistors R19 and R20 are application dependent. Note that when choosing different values for the input resistors to properly attenuate a 10V signal to a 4V signal, $R19 = 1.5 \times R20$.

To use the on-board isolated power supplies, move the shunts on jumper JU1 and JU3 to the 1–2 position and move the shunt on jumper JU2 to the 2–3 position. To use an external power supply, move the shunts on jumper JU1 and JU3 to the 2–3 position and move the shunt on jumper JU2 to the 1–2 position. Connect the ground terminal of the external power supply to the GND2 connector, the +6V to +12V supply to the EXT_V+ connector, and the -3.3V to -5V supply to the EXT_V- connector. See Table 1 for the jumper settings and the input current requirements.

Detailed Description of Firmware

The Fresno firmware design was initially released for the Nexys 3 development kit and targeted a Microblaze™ soft core microcontroller placed inside a Xilinx® Spartan-6 FPGA. Support for additional platforms may be added periodically under [Firmware Files](#) in the [All Design Files](#) section. The currently supported platforms and ports are shown in Table 2.

The firmware is a working example of how to interface to the hardware, collect samples, and save them to memory. The simple process flow is shown in **Figure 2**. The firmware is written in C using the Xilinx SDK tool, which is based on the Eclipse™ open source standard. Custom Fresno-specific design functions were created utilizing the standard Xilinx XSpi core version 3.03a. The SPI clock frequency is set to 3.125MHz.

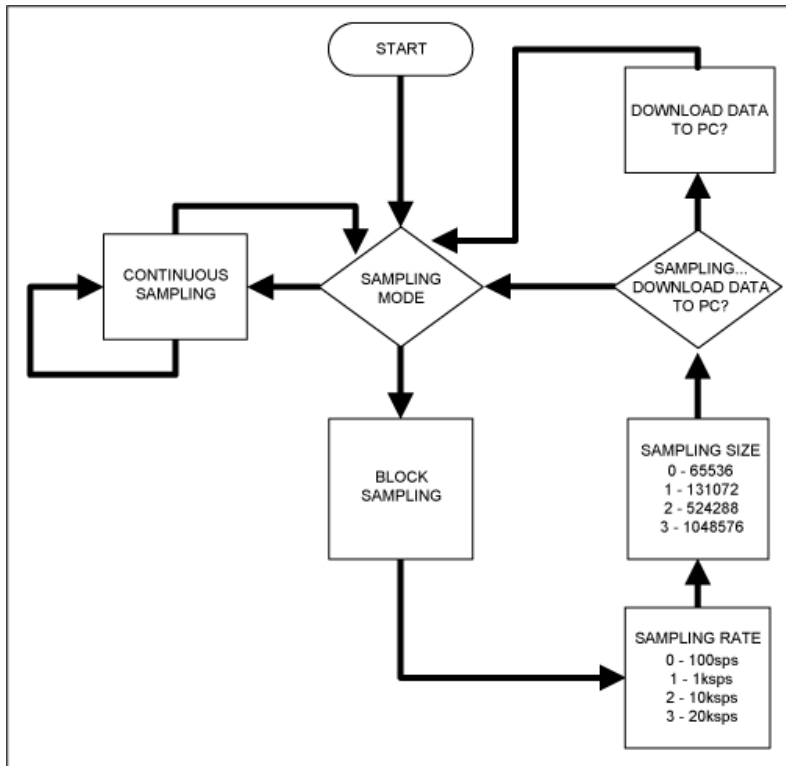

Figure 2. The Fresno firmware flowchart.

The firmware accepts commands, writes status, and is capable of downloading blocks of sampled data to a standard terminal program via a virtual COM port. The complete source code is provided to speed up customer development. Code documentation can be found in the corresponding firmware platform files.

Quick Start

Required equipment:

- Windows® PC with two USB ports
- Fresno (MAXREFDES11#) Board
- Fresno-supported Platform (i.e., Nexys 3 development kit)
- Industrial sensor or signal source

Download, read, and carefully follow each step in the [Fresno \(MAXREFDES11#\) Nexys 3 Quick Start Guide](#).

Lab Measurements

Equipment used:

- Audio Precision® SYS-2722 signal source or equivalent
- Voltage calibrator DVC-8500
- Windows PC with two USB ports
- Fresno (MAXREFDES11#) board
- Nexys 3 development kit
- +10V power supply
- -5V power supply

Special care must be taken and the proper equipment must be used when testing the Fresno design. The key to testing any high-accuracy design is to use sources and measurement equipment that are of higher accuracy than the design under test. A low distortion signal source is absolutely required in order to duplicate the presented results. The input signal was generated using the Audio Precision SYS-2722. The FFTs were created using the FFT control in SignalLab from [Mitov Software](#).

AC and DC performance for on-board isolated power is shown in **Figure 3** and **Figure 4**. AC and DC performance for external power is shown in **Figure 5** and **Figure 6**.

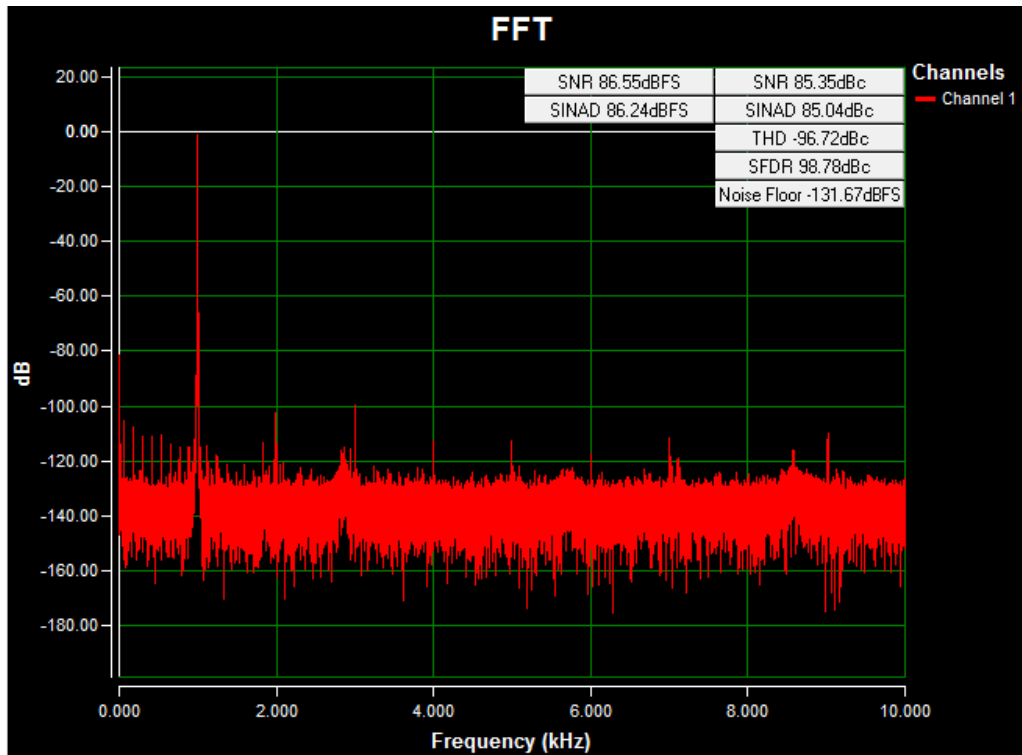

Figure 3. AC FFT using on-board isolated power, a 0 to 10V 1kHz sine wave input signal, high-impedance input, a 20ksps sample rate, and a Blackman-Harris window.

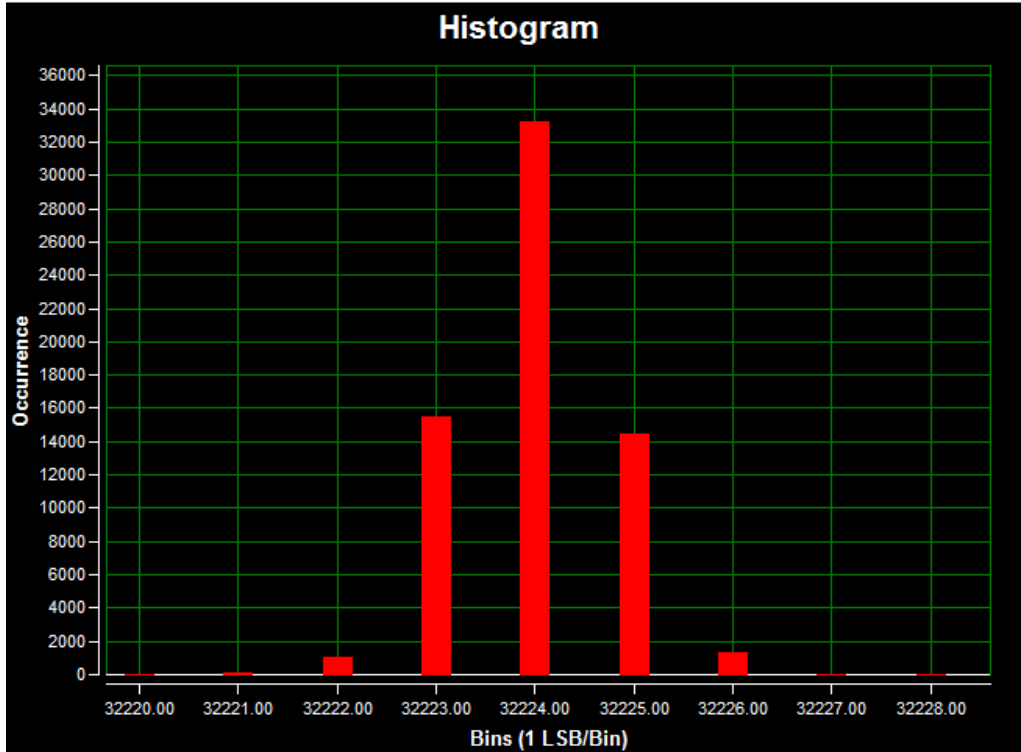

Figure 4. DC histogram using on-board isolated power; a 5V input signal; a 20ksp/s sample rate; 65,536 samples; a code spread of 8 LSBs with 96.3% of the codes falling within the three center LSBs; and a standard deviation of 0.785.

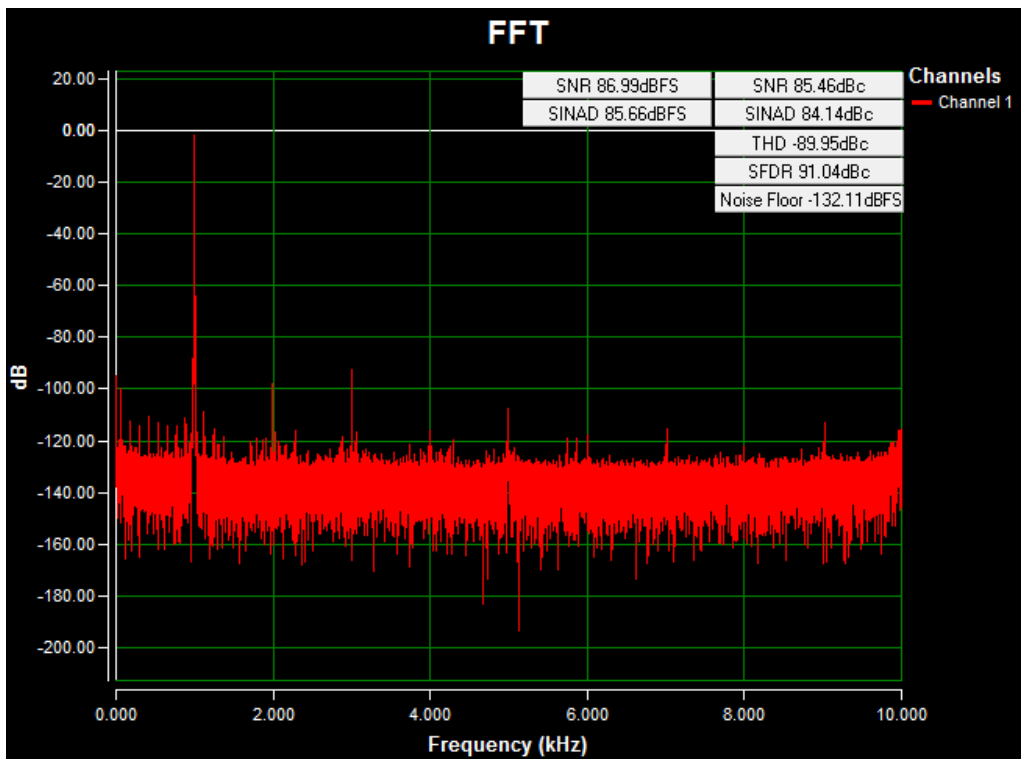

Figure 5. AC FFT using external power, a 0 to 10V 1kHz sine wave input signal, a 20ksp/s sample rate, and a Blackman-Harris window.

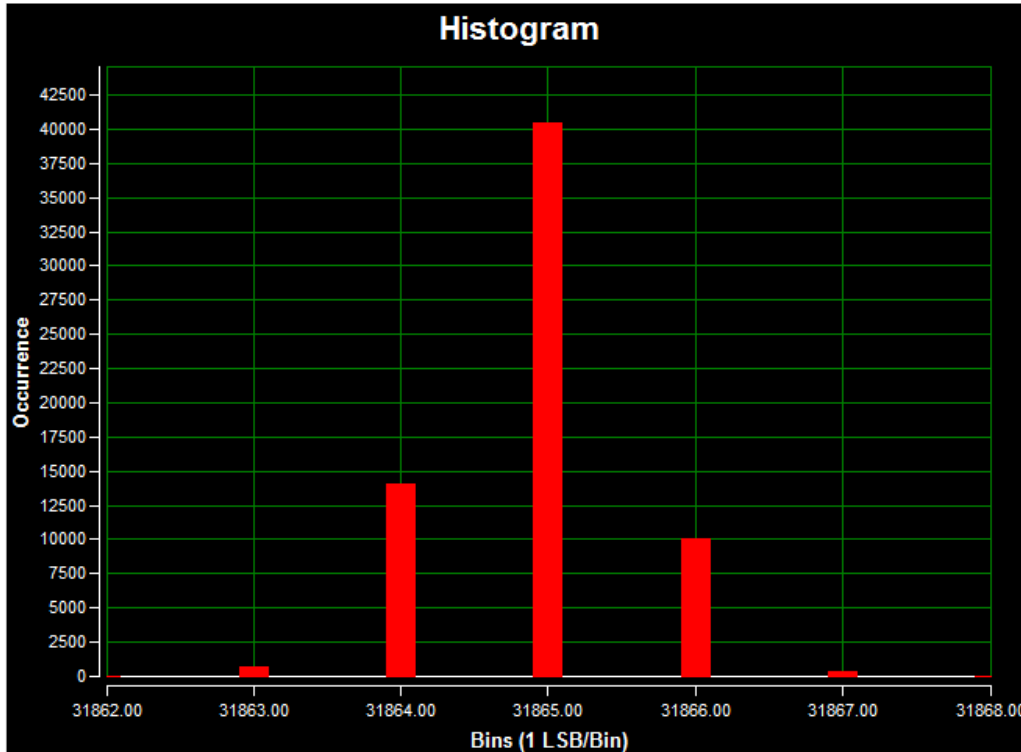

Figure 6. DC histogram using external power; a 5V input signal; a 20ksps sample rate; 65,536 samples; a code spread of 7 LSBs with 98.5% of the codes falling within the three center LSBs; and a standard deviation of 0.651.

All Design Files

[Download all design files.](#)

Hardware Files

[Schematic](#)
[Bill of materials \(BOM\)](#)
[PCB layout](#)
[PCB Gerber](#)
[PCB CAD \(PADS 9.0\)](#)

Firmware Files

[Nexys 3 platform \(Spartan-6\)](#)

Buy Reference Design

[Fresno \(MAXREFDES11#\)](#)

Audio Precision is a registered trademark of Audio Precision, Inc.
 AutoShutdown is a trademark of Maxim Integrated Products, Inc.
 Eclipse is a trademark of Eclipse Foundation, Inc.
 Halo is a registered trademark of Halo Electronics, Inc.
 MicroBlaze is a trademark of Xilinx, Inc.
 Nexys is a trademark of Digilent Inc.
 Pmod is a trademark of Digilent Inc.
 Spartan is a registered trademark of Xilinx, Inc.
 Windows is a registered trademark and registered service mark of Microsoft Corporation.

Xilinx is a registered trademark and registered service mark of Xilinx, Inc.

Related Parts		
MAX11100	16-Bit, +5V, 200ksps ADC with 10µA Shutdown	Free Samples
MAX14850	Six-Channel Digital Isolator	
MAX1659	350mA, 16.5V Input, Low-Dropout Linear Regulators	Free Samples
MAX1735	200mA, Negative-Output, Low-Dropout Linear Regulator in SOT23	Free Samples
MAX256	3W Primary-Side Transformer H-Bridge Driver for Isolated Supplies	Free Samples
MAX44250	20V, Ultra-Precision, Low-Noise Op Amps	Free Samples
MAX6126	Ultra-High-Precision, Ultra-Low-Noise, Series Voltage Reference	Free Samples
MAXREFDES11	Fresno (MAXREFDES11#): 16-Bit High-Accuracy 0 to 10V Input Isolated Analog Front End (AFE)	

More Information

For Technical Support: <http://www.maximintegrated.com/support>

For Samples: <http://www.maximintegrated.com/samples>

Other Questions and Comments: <http://www.maximintegrated.com/contact>

Application Note 5563: <http://www.maximintegrated.com/an5563>

REFERENCE DESIGN 5563, AN5563, AN 5563, APP5563, Appnote5563, Appnote 5563

© 2013 Maxim Integrated Products, Inc.

Additional Legal Notices: <http://www.maximintegrated.com/legal>



Компания «ЭлектроПласт» предлагает заключение долгосрочных отношений при поставках импортных электронных компонентов на взаимовыгодных условиях!

Наши преимущества:

- Оперативные поставки широкого спектра электронных компонентов отечественного и импортного производства напрямую от производителей и с крупнейших мировых складов;
- Поставка более 17-ти миллионов наименований электронных компонентов;
- Поставка сложных, дефицитных, либо снятых с производства позиций;
- Оперативные сроки поставки под заказ (от 5 рабочих дней);
- Экспресс доставка в любую точку России;
- Техническая поддержка проекта, помощь в подборе аналогов, поставка прототипов;
- Система менеджмента качества сертифицирована по Международному стандарту ISO 9001;
- Лицензия ФСБ на осуществление работ с использованием сведений, составляющих государственную тайну;
- Поставка специализированных компонентов (Xilinx, Altera, Analog Devices, Intersil, Interpoint, Microsemi, Aeroflex, Peregrine, Syfer, Eurofarad, Texas Instrument, Miteq, Cobham, E2V, MA-COM, Hittite, Mini-Circuits, General Dynamics и др.);

Помимо этого, одним из направлений компании «ЭлектроПласт» является направление «Источники питания». Мы предлагаем Вам помощь Конструкторского отдела:

- Подбор оптимального решения, техническое обоснование при выборе компонента;
- Подбор аналогов;
- Консультации по применению компонента;
- Поставка образцов и прототипов;
- Техническая поддержка проекта;
- Защита от снятия компонента с производства.



Как с нами связаться

Телефон: 8 (812) 309 58 32 (многоканальный)

Факс: 8 (812) 320-02-42

Электронная почта: org@eplast1.ru

Адрес: 198099, г. Санкт-Петербург, ул. Калинина, дом 2, корпус 4, литера А.