

## Optocoupler, Phototransistor Output (Dual, Quad Channel)

Dual Channel

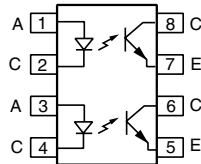

Quad Channel

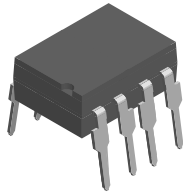
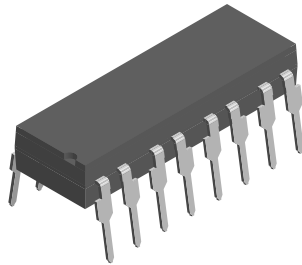

I179052

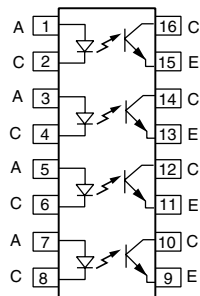

### FEATURES

- Identical channel to channel footprint
- Dual and quad packages feature:
  - Reduced board space
  - Lower pin and parts count
  - Better channel to channel CTR match
  - Improved common mode rejection
- Isolation test voltage from double molded package, 5300 V<sub>RMS</sub>
- Lead (Pb)-free component
- Component in accordance to RoHS 2002/95/EC and WEEE 2002/96/EC

**RoHS**  
COMPLIANT

### AGENCY APPROVALS

- UL1577, file no. E52744 system code H or J, double protection
- CSA 93751
- BSI IEC 60950; IEC 60065
- DIN EN 60747-5-2 (VDE 0884)/DIN EN 60747-5-5 pending available with option 1

### DESCRIPTION

The ILD615/ILQ615 are multi-channel phototransistor optocouplers that use GaAs IRLED emitters and high gain NPN phototransistors. These devices are constructed using over/under leadframe optical coupling and double molded insulation technology resulting a withstand test voltage of 7500 V<sub>AC PEAK</sub> and a working voltage of 1700 V<sub>RMS</sub>.

The binned min./max. and linear CTR characteristics make these devices well suited for DC or AC voltage detection. Eliminating the phototransistor base connection provides added electrical noise immunity from the transients found in many industrial control environments.

Because of guaranteed maximum non-saturated and saturated switching characteristics, the ILD615/ILQ615 can be used in medium speed data I/O and control systems. The binned min./max. CTR specification allow easy worst case interface calculations for both level detection and switching applications. Interfacing with a CMOS logic is enhanced by the guaranteed CTR at I<sub>F</sub> = 1.0 mA.

ORDER INFORMATION	
PART	REMARKS
ILD615-1	CTR 40 to 80 %, dual channel, DIP-8
ILD615-2	CTR 63 to 125 %, dual channel, DIP-8
ILD615-3	CTR 100 to 200 %, dual channel, DIP-8
ILD615-4	CTR 160 to 320 %, dual channel, DIP-8
ILQ615-1	CTR 40 to 80 %, quad channel, DIP-16
ILQ615-2	CTR 63 to 125 %, quad channel, DIP-16
ILQ615-3	CTR 100 to 200 %, quad channel, DIP-16
ILQ615-4	CTR 160 to 320 %, quad channel, DIP-16
ILD615-1X007	CTR 40 to 80 %, dual channel, SMD-8 (option 7)
ILD615-2X006	CTR 63 to 125 %, dual channel, DIP-8 400 mil (option 6)
ILD615-2X009	CTR 63 to 125 %, dual channel, SMD-8 (option 9)
ILD615-3X006	CTR 100 to 200 %, dual channel, DIP-8 400 mil (option 6)
ILD615-3X007	CTR 100 to 200 %, dual channel, SMD-8 (option 7)
ILD615-3X009	CTR 100 to 200 %, dual channel, SMD-8 (option 9)
ILD615-4X006	CTR 160 to 320 %, dual channel, DIP-8 400 mil (option 6)
ILD615-4X009	CTR 160 to 320 %, dual channel, SMD-8 400 mil (option 9)
ILQ615-1X009	CTR 40 to 80 %, quad channel, SMD-16 (option 9)
ILQ615-2X007	CTR 63 to 125 %, quad channel, SMD-16 (option 7)
ILQ615-3X006	CTR 100 to 200 %, quad channel, DIP-16 400 mil (option 6)
ILQ615-3X009	CTR 100 to 200 %, quad channel, SMD-16 (option 9)
ILQ615-4X007	CTR 160 to 320 %, quad channel, SMD-16 (option 7)
ILQ615-4X009	CTR 160 to 320 %, quad channel, SMD-16 (option 9)

**Note**

For additional information on the available options refer to option information.

ABSOLUTE MAXIMUM RATINGS (1)				
PARAMETER	TEST CONDITION	SYMBOL	VALUE	UNIT
<b>INPUT</b>				
Reverse voltage		$V_R$	6.0	V
Forward current		$I_F$	60	mA
Surge current		$I_{FSM}$	1.5	A
Power dissipation		$P_{diss}$	100	mW
Derate linearly from 25 °C			1.33	mW/°C
<b>OUTPUT</b>				
Collector emitter breakdown voltage		$BV_{CEO}$	70	V
Emitter collector breakdown voltage		$BV_{ECO}$	7.0	V
Collector current		$I_C$	50	mA
	t < 1.0 ms	$I_C$	100	mA
Power dissipation		$P_{diss}$	150	mW
Derate linearly from 25 °C			2.0	mW/°C



ABSOLUTE MAXIMUM RATINGS <sup>(1)</sup>				
PARAMETER	TEST CONDITION	SYMBOL	VALUE	UNIT
<b>COUPLER</b>				
Storage temperature		$T_{stg}$	- 55 to + 150	°C
Operating temperature		$T_{amb}$	- 55 to + 100	°C
Junction temperature		$T_j$	100	°C
Soldering temperature <sup>(2)</sup>	2.0 mm distance from case bottom	$T_{sld}$	260	°C
Package power dissipation ILD615			400	mW
Derate linearly from 25 °C			5.33	mW/°C
Package power dissipation ILQ615			500	mW
Derate linearly from 25 °C			6.67	mW/°C
Isolation test voltage	t = 1.0 s	$V_{ISO}$	5300	$V_{RMS}$
Creepage distance			≥ 7.0	mm
Clearance distance			≥ 7.0	mm
Isolation resistance	$V_{IO} = 500\text{ V}, T_{amb} = 25\text{ °C}$	$R_{IO}$	≥ 10 <sup>12</sup>	Ω
	$V_{IO} = 500\text{ V}, T_{amb} = 100\text{ °C}$	$R_{IO}$	≥ 10 <sup>11</sup>	Ω

**Notes**(1)  $T_{amb} = 25\text{ °C}$ , unless otherwise specified.

Stresses in excess of the absolute maximum ratings can cause permanent damage to the device. Functional operation of the device is not implied at these or any other conditions in excess of those given in the operational sections of this document. Exposure to absolute maximum ratings for extended periods of the time can adversely affect reliability.

(2) Refer to reflow profile for soldering conditions for surface mounted devices (SMD). Refer to wave profile for soldering conditions for through hole devices (DIP).

ELECTRICAL CHARACTERISTICS						
PARAMETER	TEST CONDITION	SYMBOL	MIN.	TYP.	MAX.	UNIT
<b>INPUT</b>						
Forward voltage	$I_F = 10\text{ mA}$	$V_F$	1.0	1.15	1.3	V
Breakdown voltage	$I_R = 10\text{ }\mu\text{A}$	$V_{BR}$	6.0	30		V
Reverse current	$V_R = 6.0\text{ V}$	$I_R$		0.01	10	μA
Capacitance	$V_R = 0\text{ V}, f = 1.0\text{ MHz}$	$C_O$		25		pF
Thermal resistance, junction to lead		$R_{THJL}$		750		K/W
<b>OUTPUT</b>						
Collector emitter capacitance	$V_{CE} = 5.0\text{ V}, f = 1.0\text{ MHz}$	$C_{CE}$		6.8		pF
Collector emitter leakage current, -1, -2	$V_{CE} = 10\text{ V}$	$I_{CEO}$		2.0	50	nA
Collector emitter leakage current, -3, -4	$V_{CE} = 10\text{ V}$	$I_{CEO}$		5.0	100	nA
Collector emitter breakdown voltage	$I_{CE} = 0.5\text{ mA}$	$BV_{CEO}$	70			V
Emitter collector breakdown voltage	$I_E = 0.1\text{ mA}$	$BV_{ECO}$	7.0			V
Thermal resistance, junction to lead		$R_{THJL}$		500		K/W
<b>PACKAGE TRANSFER CHARACTERISTICS</b>						
Channel/channel CTR match	$I_F = 10\text{ mA}, V_{CE} = 5.0\text{ V}$	CTR <sub>X</sub> /CTR <sub>Y</sub>	1 to 1		2 to 1	
<b>COUPLER</b>						
Capacitance (input to output)	$V_{IO} = 0\text{ V}, f = 1.0\text{ MHz}$	$C_{IO}$		0.8		pF
Insulation resistance	$V_{IO} = 500\text{ V}, T_A = 25\text{ °C}$	$R_S$	10 <sup>12</sup>	10 <sup>14</sup>		Ω
Channel to channel isolation			500			VAC

**Note** $T_{amb} = 25\text{ °C}$ , unless otherwise specified.

Minimum and maximum values are tested requirements. Typical values are characteristics of the device and are the result of engineering evaluations. Typical values are for information only and are not part of the testing requirements.

CURRENT TRANSFER RATIO								
PARAMETER	TEST CONDITION	PART	SYMBOL	MIN.	TYP.	MAX.	UNIT	
Current transfer ratio (collector emitter saturated)	$I_F = 10 \text{ mA}, V_{CE} = 0.4 \text{ V}$	ILD615-1	$CTR_{CEsat}$		25		%	
		ILQ615-1						
		ILD615-2	$CTR_{CEsat}$		40		%	
		ILQ615-2						
		ILD615-3	$CTR_{CEsat}$		60		%	
		ILQ615-3						
ILD615-4	$CTR_{CEsat}$		100		%			
ILQ615-4								
Current transfer ratio (collector emitter)	$I_F = 1.0 \text{ mA}, V_{CE} = 5.0 \text{ V}$	ILD615-1	$CTR_{CE}$	13	30		%	
		ILQ615-1						
		ILD615-2	$CTR_{CE}$	22	45		%	
		ILQ615-2						
		ILD615-3	$CTR_{CE}$	34	70		%	
		ILQ615-3						
	ILD615-4	$CTR_{CE}$	56	90		%		
	ILQ615-4							
	$I_F = 10 \text{ mA}, V_{CE} = 5.0 \text{ V}$	ILD615-1	$CTR_{CE}$	40	60	80		%
		ILQ615-1						
		ILD615-2	$CTR_{CE}$	63	80	125		%
		ILQ615-2						
ILD615-3		$CTR_{CE}$	100	150	200		%	
ILQ615-3								
ILD615-4	$CTR_{CE}$	160	200	320		%		
ILQ615-4								

SWITCHING CHARACTERISTICS							
PARAMETER	TEST CONDITION	PART	SYMBOL	MIN.	TYP.	MAX.	UNIT
<b>NON-SATURATED</b>							
Current	$V_{CC} = 5.0 \text{ V}, R_L = 75 \Omega, 50 \% \text{ of } V_{PP}$		$I_F$		10		mA
Turn-on time	$V_{CC} = 5.0 \text{ V}, R_L = 75 \Omega, 50 \% \text{ of } V_{PP}$		$t_{on}$		3.0		$\mu\text{s}$
Rise time	$V_{CC} = 5.0 \text{ V}, R_L = 75 \Omega, 50 \% \text{ of } V_{PP}$		$t_r$		2.0		$\mu\text{s}$
Turn-off time	$V_{CC} = 5.0 \text{ V}, R_L = 75 \Omega, 50 \% \text{ of } V_{PP}$		$t_{off}$		2.3		$\mu\text{s}$
Fall time	$V_{CC} = 5.0 \text{ V}, R_L = 75 \Omega, 50 \% \text{ of } V_{PP}$		$t_f$		2.0		$\mu\text{s}$
Propagation H to L	$V_{CC} = 5.0 \text{ V}, R_L = 75 \Omega, 50 \% \text{ of } V_{PP}$		$t_{PHL}$		1.1		$\mu\text{s}$
Propagation L to H	$V_{CC} = 5.0 \text{ V}, R_L = 75 \Omega, 50 \% \text{ of } V_{PP}$		$t_{PLH}$		2.5		$\mu\text{s}$
<b>SATURATED</b>							
Current	$V_{CC} = 5.0 \text{ V}, R_L = 1.0 \text{ k}\Omega, V_{TH} = 1.5 \text{ V}$	ILD615-1	$I_F$		20		mA
		ILQ615-1					
		ILD615-2	$I_F$		10		mA
		ILQ615-2					
		ILD615-3	$I_F$		10		mA
		ILQ615-3					
ILD615-4	$I_F$		5.0		mA		
ILQ615-4							



<b>SWITCHING CHARACTERISTICS</b>							
PARAMETER	TEST CONDITION	PART	SYMBOL	MIN.	TYP.	MAX.	UNIT
<b>SATURATED</b>							
Turn-on time	$V_{CC} = 5.0\text{ V}, R_L = 1.0\text{ k}\Omega,$ $V_{TH} = 1.5\text{ V}$	ILD615-1	$t_{on}$		3.0		$\mu\text{s}$
		ILQ615-1					
		ILD615-2	$t_{on}$		4.3		$\mu\text{s}$
		ILQ615-2					
		ILD615-3	$t_{on}$		4.3		$\mu\text{s}$
		ILQ615-3					
ILD615-4	$t_{on}$		6.0		$\mu\text{s}$		
ILQ615-4							
Rise time	$V_{CC} = 5.0\text{ V}, R_L = 1.0\text{ k}\Omega,$ $V_{TH} = 1.5\text{ V}$	ILD615-1	$t_r$		2.0		$\mu\text{s}$
		ILQ1615-1					
		ILD615-2	$t_r$		2.8		$\mu\text{s}$
		ILQ615-2					
		ILD615-3	$t_r$		2.8		$\mu\text{s}$
		ILQ615-3					
ILD615-4	$t_r$		4.6		$\mu\text{s}$		
ILQ615-4							
Turn-off time	$V_{CC} = 5.0\text{ V}, R_L = 1.0\text{ k}\Omega,$ $V_{TH} = 1.5\text{ V}$	ILD615-1	$t_{off}$		18		$\mu\text{s}$
		ILQ615-1					
		ILD615-2	$t_{off}$		25		$\mu\text{s}$
		ILQ615-2					
		ILD615-3	$t_{off}$		25		$\mu\text{s}$
		ILQ615-3					
ILD615-4	$t_{off}$		25		$\mu\text{s}$		
ILQ615-4							
Fall time	$V_{CC} = 5.0\text{ V}, R_L = 1.0\text{ k}\Omega,$ $V_{TH} = 1.5\text{ V}$	ILD615-1	$t_f$		11		$\mu\text{s}$
		ILQ615-1					
		ILD615-2	$t_f$		14		$\mu\text{s}$
		ILQ615-2					
		ILD615-3	$t_f$		14		$\mu\text{s}$
		ILQ615-3					
ILD615-4	$t_f$		15		$\mu\text{s}$		
ILQ615-4							
Propagation H to L	$V_{CC} = 5.0\text{ V}, R_L = 1.0\text{ k}\Omega,$ $V_{TH} = 1.5\text{ V}$	ILD615-1	$t_{PHL}$		1.6		$\mu\text{s}$
		ILQ615-1					
		ILD615-2	$t_{PHL}$		2.6		$\mu\text{s}$
		ILQ615-2					
		ILD615-3	$t_{PHL}$		2.6		$\mu\text{s}$
		ILQ615-3					
ILD615-4	$t_{PHL}$		5.4		$\mu\text{s}$		
ILQ615-4							

SWITCHING CHARACTERISTICS							
PARAMETER	TEST CONDITION	PART	SYMBOL	MIN.	TYP.	MAX.	UNIT
<b>SATURATED</b>							
Propagation L to H	$V_{CC} = 5.0\text{ V}$ , $R_L = 1.0\text{ k}\Omega$ , $V_{TH} = 1.5\text{ V}$	ILD615-1	$t_{PLH}$		8.6		$\mu\text{s}$
		ILQ615-1					
		ILD615-2	$t_{PLH}$		7.2		$\mu\text{s}$
		ILQ615-2					
		ILD615-3	$t_{PLH}$		7.2		$\mu\text{s}$
		ILQ615-3					
ILD615-4	$t_{PLH}$		7.4		$\mu\text{s}$		
ILQ615-4							

COMMON MODE TRANSIENT IMMUNITY							
PARAMETER	TEST CONDITION	SYMBOL	MIN.	TYP.	MAX.	UNIT	
Common mode rejection output high	$V_{CM} = 50\text{ V}_{P-P}$ , $R_L = 1.0\text{ k}\Omega$ , $I_F = 0\text{ mA}$	$CM_H$		5000		$\text{V}/\mu\text{s}$	
Common mode rejection output low	$V_{CM} = 50\text{ V}_{P-P}$ , $R_L = 1.0\text{ k}\Omega$ , $I_F = 0\text{ mA}$	$CM_L$		5000		$\text{V}/\mu\text{s}$	
Common mode coupling capacitance		$C_{CM}$		0.01		$\text{pF}$	

### TYPICAL CHARACTERISTICS

$T_{amb} = 25\text{ }^\circ\text{C}$ , unless otherwise specified

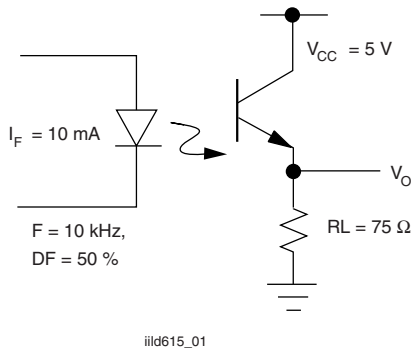

Fig. 1 - Non-Saturated Switching Timing

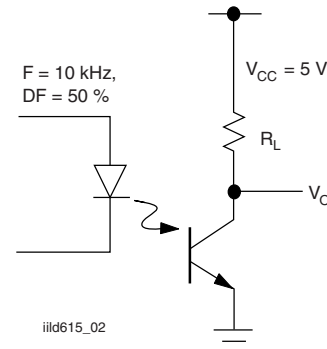

Fig. 2 - Saturated Switching Timing

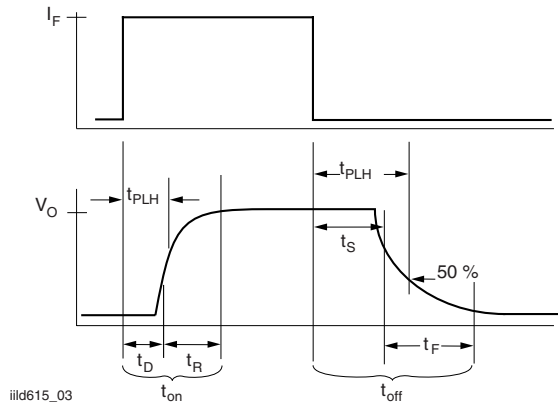

Fig. 3 - Non-Saturated Switching Timing

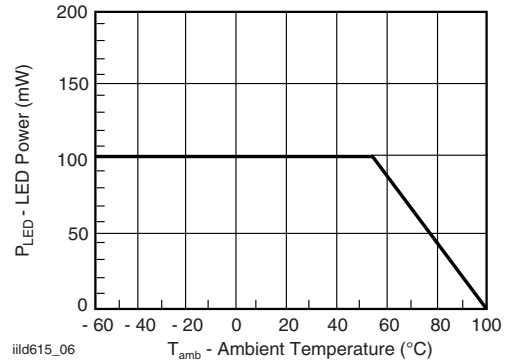

Fig. 6 - Maximum LED Power Dissipation

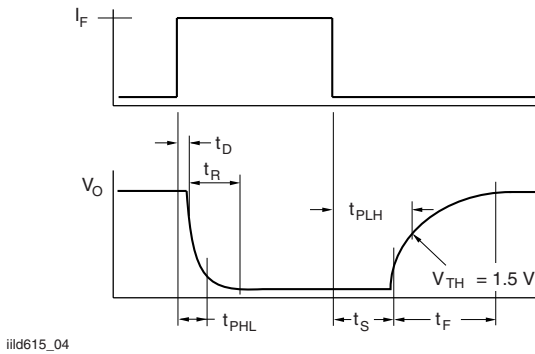

Fig. 4 - Saturated Switching Timing

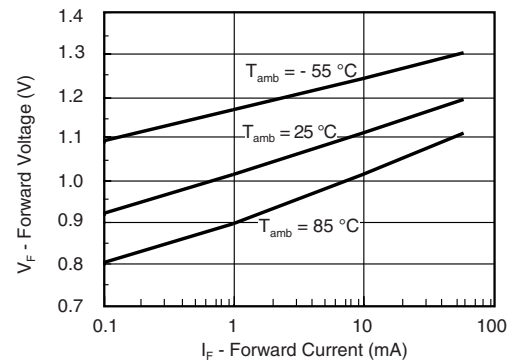

Fig. 7 - Forward Voltage vs. Forward Current

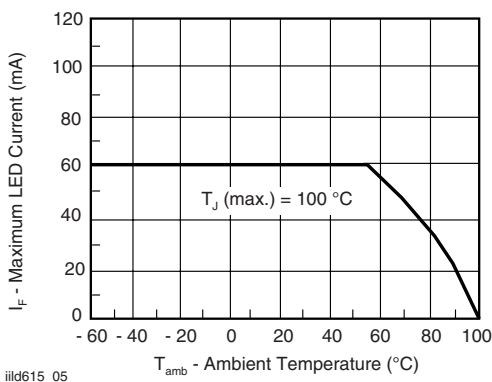

Fig. 5 - Maximum LED Current vs. Ambient Temperature

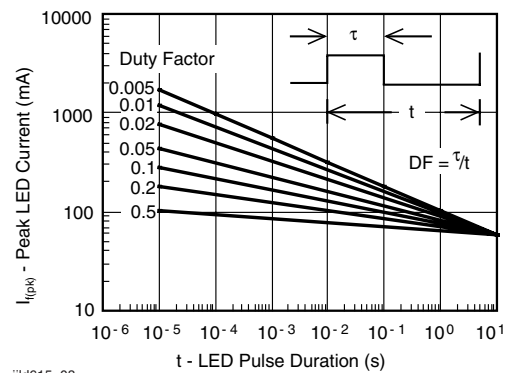
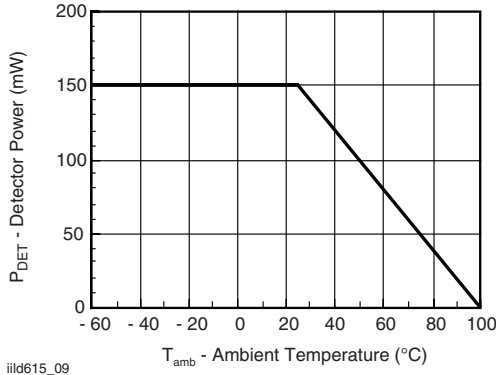
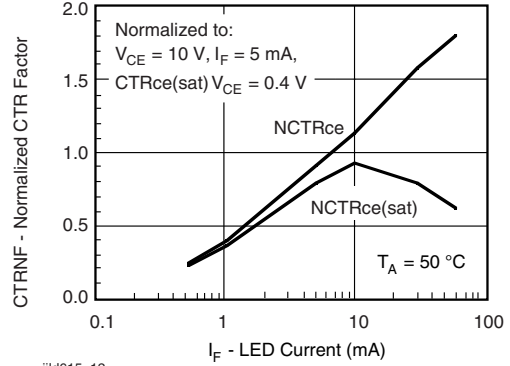

Fig. 8 - Peak LED Current vs. Pulse Duration,  $\tau$



iiid615\_09

Fig. 9 - Maximum Detector Power Dissipation



iiid615\_12

Fig. 12 - Normalization Factor for Non-Saturated and Saturated CTR vs.  $I_F$

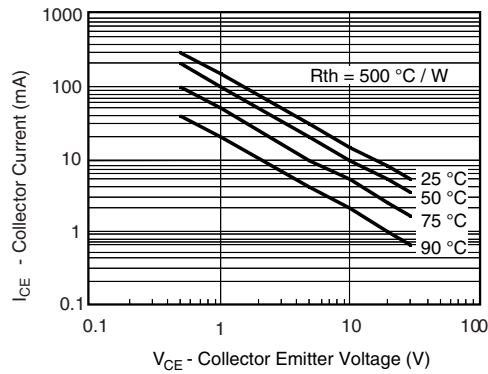

iiid615\_10

Fig. 10 - Maximum Collector Current vs. Collector Voltage

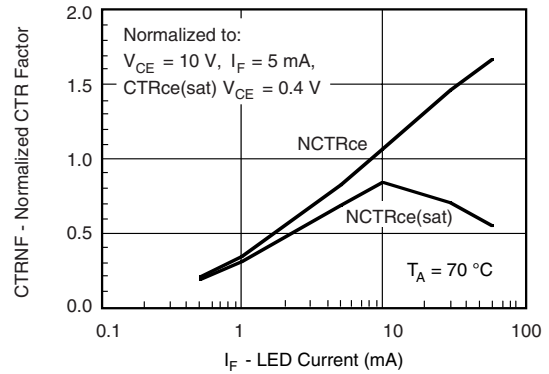

iiid615\_13

Fig. 13 - Normalization Factor for Non-Saturated and Saturated CTR vs.  $I_F$

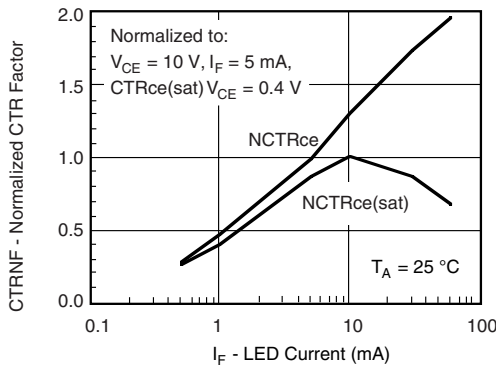

iiid615\_11

Fig. 11 - Normalization Factor for Non-Saturated and Saturated CTR vs.  $I_F$

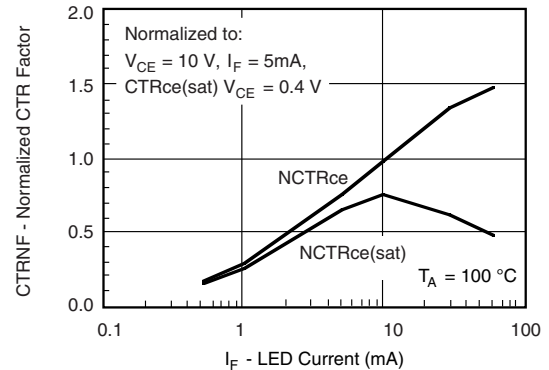

iiid615\_14

Fig. 14 - Normalization Factor for Non-Saturated and Saturated CTR vs.  $I_F$



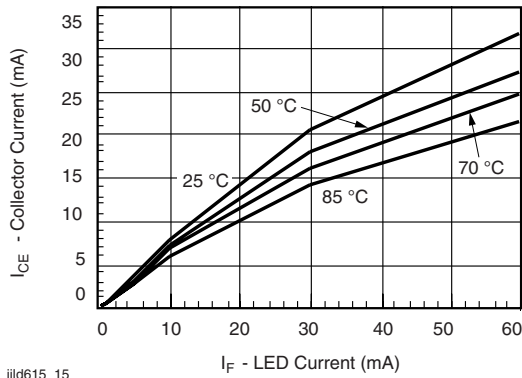

iiid615\_15

Fig. 15 - Collector Emitter Current vs. Temperature and LED Current

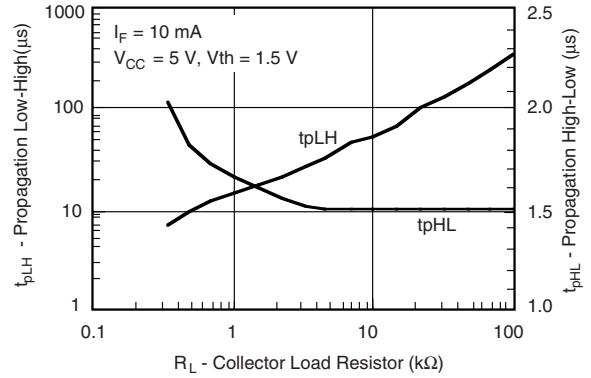

iiid615\_18

Fig. 18 - -2, -3, Propagation Delay vs. Collector Load Resistor

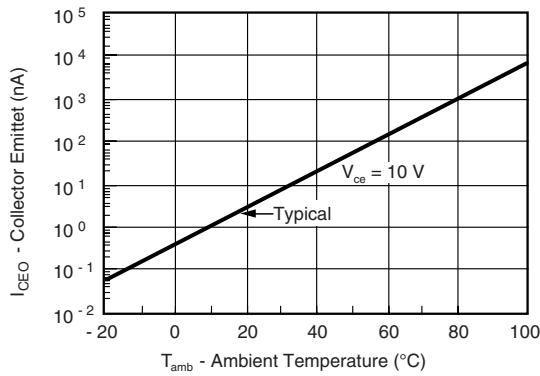

iiid615\_16

Fig. 16 - Collector Emitter Leakage vs. Temperature

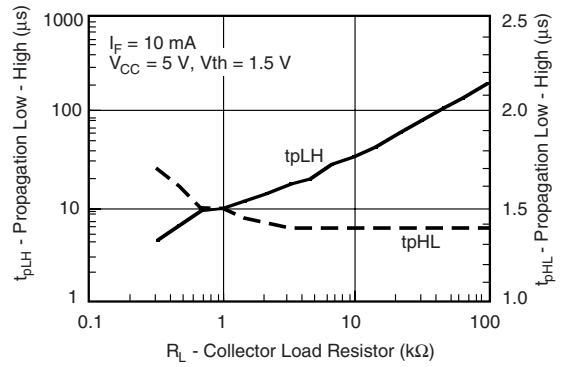

iiid615\_19

Fig. 19 - -4, Propagation Delay vs. Collector Load Resistor

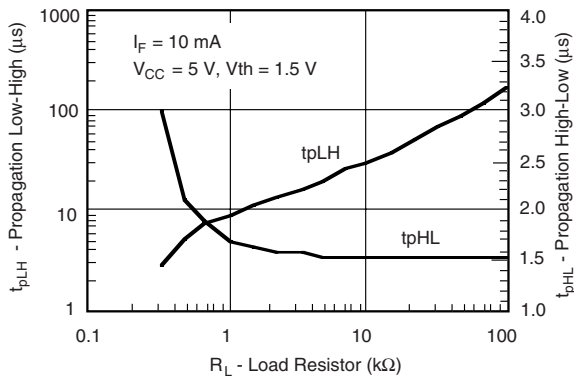

iiid615\_17

Fig. 17 - -1, Propagation Delay vs. Collector Load Resistor

# ILD615/ILQ615



Vishay Semiconductors Optocoupler, Phototransistor Output  
(Dual, Quad Channel)

## PACKAGE DIMENSIONS in inches (millimeters)

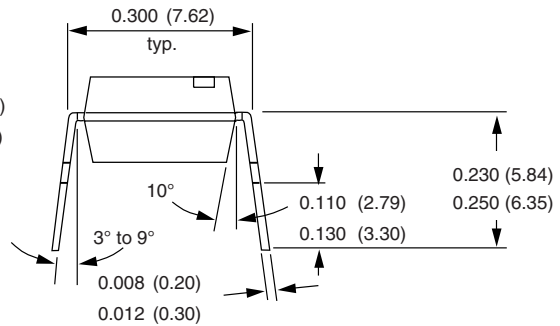
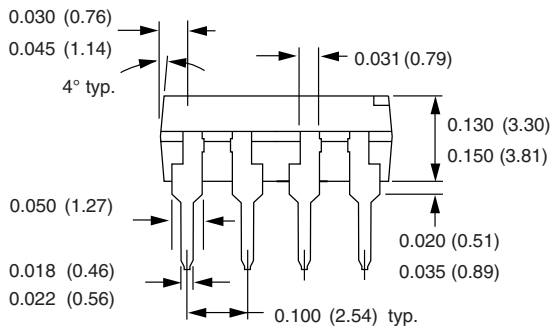
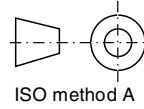
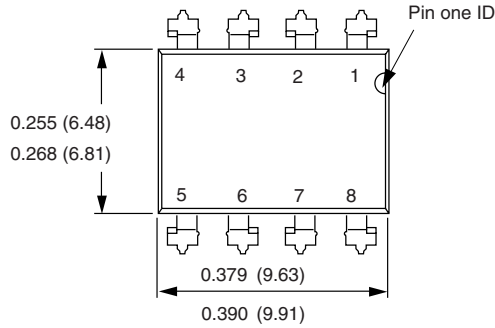

i178006

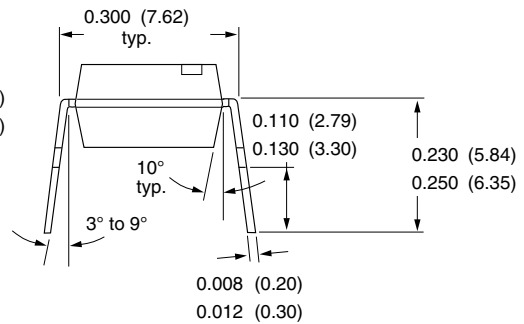
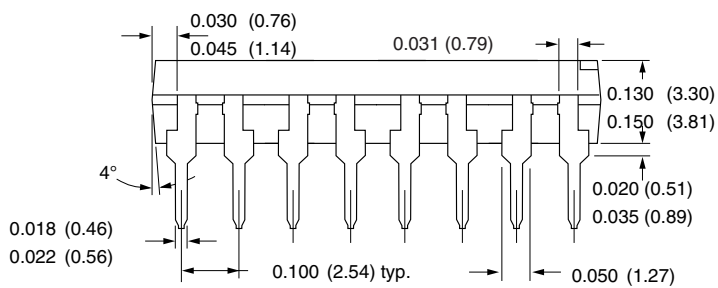
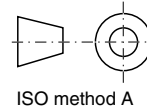
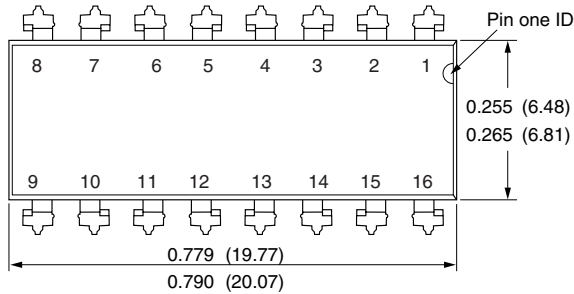

i178007



Option 6

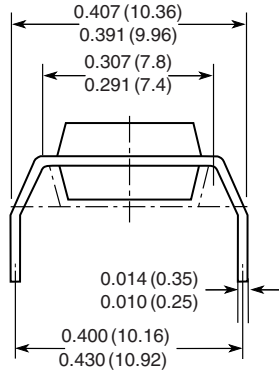

Option 7

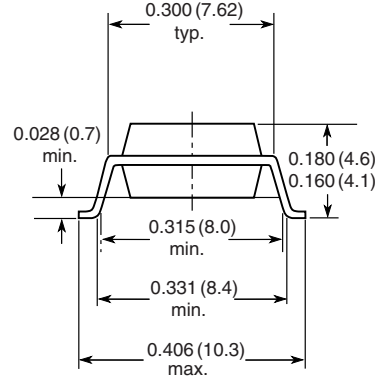

Option 9

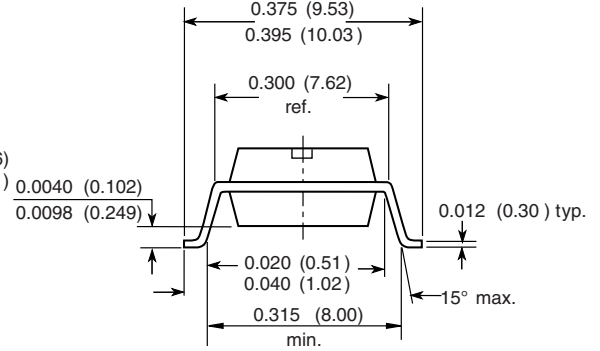

18450



## **OZONE DEPLETING SUBSTANCES POLICY STATEMENT**

It is the policy of Vishay Semiconductor GmbH to

1. Meet all present and future national and international statutory requirements.
2. Regularly and continuously improve the performance of our products, processes, distribution and operating systems with respect to their impact on the health and safety of our employees and the public, as well as their impact on the environment.

It is particular concern to control or eliminate releases of those substances into the atmosphere which are known as ozone depleting substances (ODSs).

The Montreal Protocol (1987) and its London Amendments (1990) intend to severely restrict the use of ODSs and forbid their use within the next ten years. Various national and international initiatives are pressing for an earlier ban on these substances.

Vishay Semiconductor GmbH has been able to use its policy of continuous improvements to eliminate the use of ODSs listed in the following documents.

1. Annex A, B and list of transitional substances of the Montreal Protocol and the London Amendments respectively.
2. Class I and II ozone depleting substances in the Clean Air Act Amendments of 1990 by the Environmental Protection Agency (EPA) in the USA.
3. Council Decision 88/540/EEC and 91/690/EEC Annex A, B and C (transitional substances) respectively.

Vishay Semiconductor GmbH can certify that our semiconductors are not manufactured with ozone depleting substances and do not contain such substances.

We reserve the right to make changes to improve technical design  
and may do so without further notice.

Parameters can vary in different applications. All operating parameters must be validated for each customer application by the customer. Should the buyer use Vishay Semiconductors products for any unintended or unauthorized application, the buyer shall indemnify Vishay Semiconductors against all claims, costs, damages, and expenses, arising out of, directly or indirectly, any claim of personal damage, injury or death associated with such unintended or unauthorized use.

Vishay Semiconductor GmbH, P.O.B. 3535, D-74025 Heilbronn, Germany



### Disclaimer

All product specifications and data are subject to change without notice.

Vishay Intertechnology, Inc., its affiliates, agents, and employees, and all persons acting on its or their behalf (collectively, "Vishay"), disclaim any and all liability for any errors, inaccuracies or incompleteness contained herein or in any other disclosure relating to any product.

Vishay disclaims any and all liability arising out of the use or application of any product described herein or of any information provided herein to the maximum extent permitted by law. The product specifications do not expand or otherwise modify Vishay's terms and conditions of purchase, including but not limited to the warranty expressed therein, which apply to these products.

No license, express or implied, by estoppel or otherwise, to any intellectual property rights is granted by this document or by any conduct of Vishay.

The products shown herein are not designed for use in medical, life-saving, or life-sustaining applications unless otherwise expressly indicated. Customers using or selling Vishay products not expressly indicated for use in such applications do so entirely at their own risk and agree to fully indemnify Vishay for any damages arising or resulting from such use or sale. Please contact authorized Vishay personnel to obtain written terms and conditions regarding products designed for such applications.

Product names and markings noted herein may be trademarks of their respective owners.



Компания «ЭлектроПласт» предлагает заключение долгосрочных отношений при поставках импортных электронных компонентов на взаимовыгодных условиях!

Наши преимущества:

- Оперативные поставки широкого спектра электронных компонентов отечественного и импортного производства напрямую от производителей и с крупнейших мировых складов;
- Поставка более 17-ти миллионов наименований электронных компонентов;
- Поставка сложных, дефицитных, либо снятых с производства позиций;
- Оперативные сроки поставки под заказ (от 5 рабочих дней);
- Экспресс доставка в любую точку России;
- Техническая поддержка проекта, помощь в подборе аналогов, поставка прототипов;
- Система менеджмента качества сертифицирована по Международному стандарту ISO 9001;
- Лицензия ФСБ на осуществление работ с использованием сведений, составляющих государственную тайну;
- Поставка специализированных компонентов (Xilinx, Altera, Analog Devices, Intersil, Interpoint, Microsemi, Aeroflex, Peregrine, Syfer, Eurofarad, Texas Instrument, Miteq, Cobham, E2V, MA-COM, Hittite, Mini-Circuits, General Dynamics и др.);

Помимо этого, одним из направлений компании «ЭлектроПласт» является направление «Источники питания». Мы предлагаем Вам помощь Конструкторского отдела:

- Подбор оптимального решения, техническое обоснование при выборе компонента;
- Подбор аналогов;
- Консультации по применению компонента;
- Поставка образцов и прототипов;
- Техническая поддержка проекта;
- Защита от снятия компонента с производства.



#### Как с нами связаться

**Телефон:** 8 (812) 309 58 32 (многоканальный)

**Факс:** 8 (812) 320-02-42

**Электронная почта:** [org@eplast1.ru](mailto:org@eplast1.ru)

**Адрес:** 198099, г. Санкт-Петербург, ул. Калинина, дом 2, корпус 4, литера А.