

## Overview

The KEMET EC2/EE2 miniature signal relays offer a compact case size in a slim package. Minimal board space is consumed with either a through-hole or surface mount configuration. These relays are recognized by UL and CSA, while also being compliant with Part 68 of the FCC's 1,500 V surge capacity.

## Applications

- Electronic switching systems
- PBX
- Terminal equipment
- Telephone systems

## Benefits

- Low power consumption (< 200 mW)
- Compact and lightweight
- Low magnetic interference
- Tube or embossed tape and reel packaging
- UL recognized (E73266) and CSA certified (LR46266)
- Surface mount and through-hole options
- High Breakdown Voltage (NKX) type can withstand 1.5 kVAC at open contacts

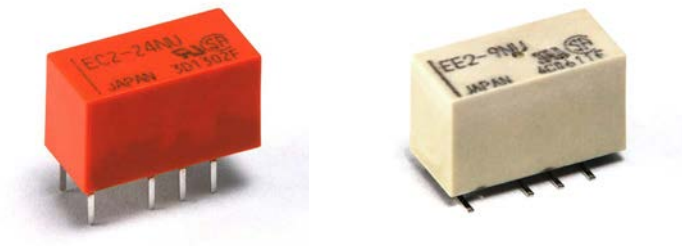

## Part Number System

EE2-	3	S	NU	-L
Series	Coil Voltage	Latch Type	Lead Type	Packaging
EC2- = Through-hole mount EE2- = Surface mount	3 = 3 VDC 4.5 = 4.5 VDC 5 = 5 VDC 12 = 12 VDC 24 = 24 VDC	Blank = Non-latch type S = Single coil latch type T = Double coil latch type	NU = Standard NUH = Minimum footprint NUX = High solder joint reliability NKX = High breakdown voltage and high solder joint reliability	Blank = Tube -L = Embossed tape on reel

## Dimensions – Millimeters

### EC2 Series

Non-latch type and single coil latch type



Double coil latch type

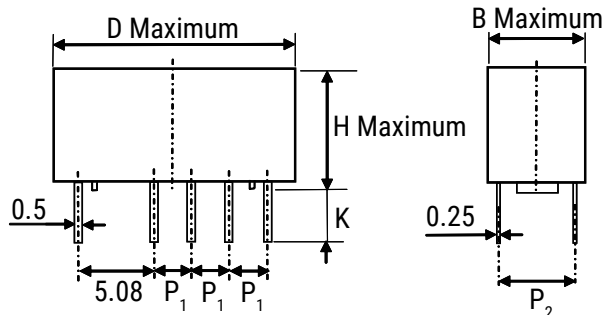

### EE2 Series

Non-latch type and single coil latch type



Double coil latch type



Series	D	H	B	P <sub>1</sub>	P <sub>2</sub>	P <sub>3</sub>	K
EC2 (NU)	15.0	9.4	7.5	2.54	5.08	–	3.2
EE2 (NU)	15.0	10.0	7.5	2.54	5.08	9.5	1.0
EE2 (NUH)	15.0	10.0	7.5	2.54	5.08	7.5	1.0
EE2 (NUX, NKX)	15.0	10.35	7.5	2.54	5.08	9.0	1.35



General tolerance: ±0.2

## Pin Configurations

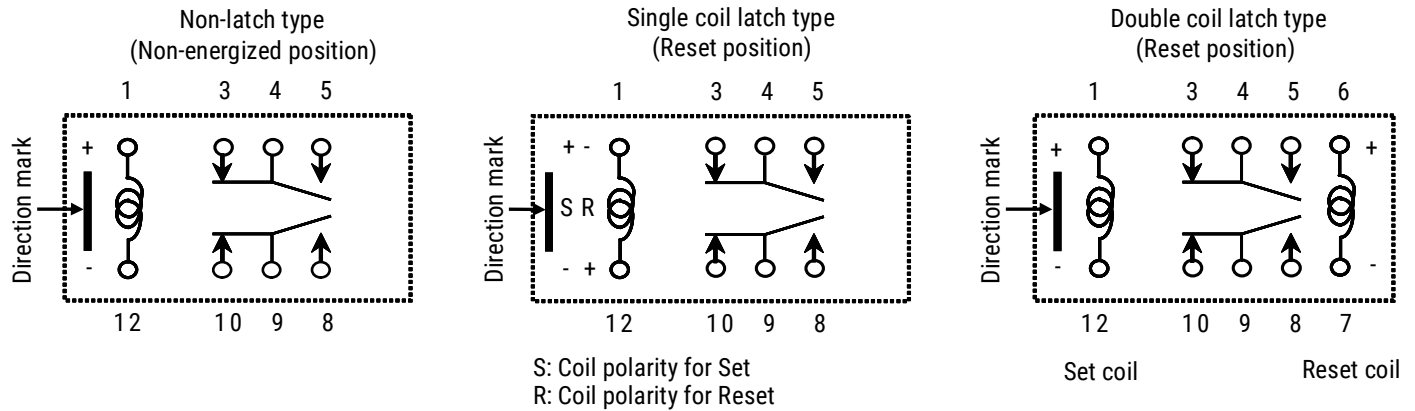
### Bottom view



## Safety Standards and Ratings

Certification Body	Mark	Specification	File Number	Rating
UL		UL Recognized (UL508) <sup>1</sup>	E73266	30 VDC, 2 A (resistive) 110 VDC, 0.3 A (resistive) 125 VAC, 0.5 A (resistive)
CSA		CSA Certified (CSA 22.2 #14)	LR46266	

<sup>1</sup> Spacing: UL114, UL478

Certification Body	Mark	Lead Type	Specification	File Number	Class	Rating
TUV		NU, NUH, NUX (Non-latch and Single coil)	TUV Certified (EN61810)	R 9751153	Basic insulation	Creepage and clearance of coil to contact is more than 2 mm (According to EN60950)

## Environmental Compliance

All KEMET relays are RoHS Compliant.



RoHS Compliant

**Table 1 – Ratings & Part Number Reference**

Part Number	Nominal Coil Voltage (VDC)	Lead Type	Packaging
EC2-3(1)NU	3	Radial	Tube
EC2-4.5(1)NU	4.5	Radial	Tube
EC2-5(1)NU	5	Radial	Tube
EC2-12(1)NU	12	Radial	Tube
EC2-24(1)NU	24	Radial	Tube
EE2-3(1)NU	3	Surface mount	Tube
EE2-4.5(1)NU	4.5	Surface mount	Tube
EE2-5(1)NU	5	Surface mount	Tube
EE2-12(1)NU	12	Surface mount	Tube
EE2-24(1)NU	24	Surface mount	Tube
EE2-3(1)NU-L	3	Surface mount	Tape on Reel
EE2-4.5(1)NU-L	4.5	Surface mount	Tape on Reel
EE2-5(1)NU-L	5	Surface mount	Tape on Reel
EE2-12(1)NU-L	12	Surface mount	Tape on Reel
EE2-24(1)NU-L	24	Surface mount	Tape on Reel
EE2-3(1)NUH	3	Surface mount, Minimum footprint	Tube
EE2-4.5(1)NUH	4.5	Surface mount, Minimum footprint	Tube
EE2-5(1)NUH	5	Surface mount, Minimum footprint	Tube
EE2-12(1)NUH	12	Surface mount, Minimum footprint	Tube
EE2-24(1)NUH	24	Surface mount, Minimum footprint	Tube
EE2-3(1)NUH-L	3	Surface mount, Minimum footprint	Tape on Reel
EE2-4.5(1)NUH-L	4.5	Surface mount, Minimum footprint	Tape on Reel
EE2-5(1)NUH-L	5	Surface mount, Minimum footprint	Tape on Reel
EE2-12(1)NUH-L	12	Surface mount, Minimum footprint	Tape on Reel
EE2-24(1)NUH-L	24	Surface mount, Minimum footprint	Tape on Reel
EE2-3(1)NUX	3	Surface mount, High solder joint reliability	Tube
EE2-4.5(1)NUX	4.5	Surface mount, High solder joint reliability	Tube
EE2-5(1)NUX	5	Surface mount, High solder joint reliability	Tube
EE2-12(1)NUX	12	Surface mount, High solder joint reliability	Tube
EE2-24(1)NUX	24	Surface mount, High solder joint reliability	Tube
EE2-3(1)NUX-L	3	Surface mount, High solder joint reliability	Tape on Reel
EE2-4.5(1)NUX-L	4.5	Surface mount, High solder joint reliability	Tape on Reel
EE2-5(1)NUX-L	5	Surface mount, High solder joint reliability	Tape on Reel
EE2-12(1)NUX-L	12	Surface mount, High solder joint reliability	Tape on Reel
EE2-24(1)NUX-L	24	Surface mount, High solder joint reliability	Tape on Reel
EE2-3NKX <sup>1</sup>	3	Surface mount, High breakdown voltage, High solder joint reliability	Tube
EE2-4.5NKX <sup>1</sup>	4.5	Surface mount, High breakdown voltage, High solder joint reliability	Tube
EE2-12NKX <sup>1</sup>	12	Surface mount, High breakdown voltage, High solder joint reliability	Tube
EE2-3NKX-L <sup>1</sup>	3	Surface mount, High breakdown voltage, High solder joint reliability	Tape on Reel
EE2-4.5NKX-L <sup>1</sup>	4.5	Surface mount, High breakdown voltage, High solder joint reliability	Tape on Reel
EE2-12NKX-L <sup>1</sup>	12	Surface mount, High breakdown voltage, High solder joint reliability	Tape on Reel

(1) To complete KEMET part number, leave blank for Non-latch, insert S for Single coil, or T for Double coil. Designates latch type.

<sup>1</sup> NKX type only available as Non-latch. Non-standard part, please contact KEMET to special order.

## Land Pattern – Millimeters

### EC2 Series (bottom view)

Non-latch type and single coil latch type



Double coil latch type



### EE2 Series (top view)

Non-latch type and single coil latch type



Double coil latch type



Series	V	X
EC2	5.08	–
EE2 (NU)	7.29	3.0
EE2 (NUH)	6.29	2.0
EE2 (NUX, NKX)	7.02	2.73

## Soldering Process

### EC2 – Through-hole Mounting

#### Automatic Soldering

Preheating: 110–120°C/110 seconds (maximum)

Solder temperature: 260°C maximum

Solder time: 5 seconds maximum

*Note: KEMET recommends cooling down a printed circuit board to less than 110°C within 40 seconds after soldering.*

#### Manual Soldering

Solder temperature: 350°C maximum

Solder time: 3 seconds maximum

### EE2 – Surface Mounting

IRS Method



*Note: Temperature profile shows printed circuit board surface temperature on the relay terminal portion. Please consult KEMET if you wish to use a temperature profile other than above.*

## Contact Specifications

Item		EC2/EE2
Contact Form		2 Form C
Contact Material		Silver alloy with gold alloy overlay
Contact Ratings	Maximum Switching Power	60 W, 125 VA
	Maximum Switching Voltage	220 VDC, 250 VAC
	Maximum Switching Current	2 A
	Maximum Carrying Current	2 A
Minimum Contact Ratings		10 mVDC, 10 $\mu$ A* <sup>1</sup>
Initial Contact Resistance		75 m $\Omega$ maximum (initial)
Operating Time (excluding bounce)		Approximately 2 milliseconds
Release Time (excluding bounce)		Approximately 1 millisecond
Insulation Resistance		1,000 M $\Omega$ at 500 VDC
Withstand Voltage	Between Open Contacts	NU, NUH, NUX: 1,000 VAC (for one minute), 1,500 V surge (10 x 160 $\mu$ s)* <sup>2</sup>
		NKX: Make contact: 1,500 VAC (for one minute), 2,500 V surge (2 x 10 $\mu$ s)* <sup>3</sup> Break contact: 1,000 VAC (for one minute), 1,500 V surge (10 x 160 $\mu$ s)* <sup>2</sup>
	Between Adjacent Contacts	1,000 VAC (for one minute), 1,500 V surge (10 x 160 $\mu$ s)* <sup>2</sup>
Between Coil and Contacts	Non-latch and single coil latch type: 1,500 VAC (for one minute), 2,500 V surge (2 x 10 $\mu$ s)* <sup>3</sup>	
	Double coil latch type: 1,000 VAC (for one minute), 1,500 V surge (10 x 160 $\mu$ s)* <sup>2</sup>	
Shock Resistance		735 m/s <sup>2</sup> (75 G) – misoperation 980 m/s <sup>2</sup> (100 G) – destructive failure
Vibration Resistance		10 to 55 Hz, double amplitude 3 mm (20 G) – misoperation 10 to 55 Hz, double amplitude 5 mm (30 G) – destructive failure
Ambient Temperature		-40 to +85°C
Coil Temperature Rise		18°C at nominal coil voltage (140 mW)
Running Specifications	Non-load	1 x 10 <sup>8</sup> operations (Non-latch type)* <sup>4</sup> 1 x 10 <sup>7</sup> operations (Latch type)
	Load	50 VDC 0.1 A (resistive), 1 x 10 <sup>6</sup> operations at 85°C, 5 Hz 10 VDC 10 mA (resistive), 1 x 10 <sup>6</sup> operations at 85°C, 2 Hz
Weight		Approximately 1.9 g

\*<sup>1</sup> This value is a reference value in the resistance load. Minimum capacity changes depending on the switching frequency, environment temperature, and load.

\*<sup>2</sup> Rise time: 10  $\mu$ s; decay time to half crest: 160  $\mu$ s.

\*<sup>3</sup> Rise time: 2  $\mu$ s; decay time to half crest: 10  $\mu$ s.

\*<sup>4</sup> This shows the number of operations with fatal defects. Stable characteristics are maintained for 1 x 10<sup>7</sup> operations.

## Coil Specifications

Non-latch Type (at 20°C)				
Nominal Coil Voltage (VDC)	Coil Resistance (Ω) ±10%	Operating Voltage <sup>1</sup> (VDC)	Release Voltage <sup>1</sup> (VDC)	Nominal Operating Power (mW)
3	64.3	2.25	0.3	140
4.5	145	3.38	0.45	140
5	178	3.75	0.5	140
12	1028	9.0	1.2	140
24	2880	18.0	2.4	200

<sup>1</sup> Test by pulse voltage.

Single Coil Latch Type (at 20°C) <sup>2</sup>				
Nominal Coil Voltage (VDC)	Coil Resistance (Ω) ±10%	Set Voltage <sup>1</sup> (VDC)	Reset Voltage <sup>1</sup> (VDC)	Nominal Operating Power (mW)
3	90	2.25	2.25	100
4.5	202.5	3.38	3.38	100
5	250	3.75	3.75	100
12	1440	9.0	9.0	100
24	3840	18.0	18.0	150

<sup>1</sup> Test by pulse voltage.

<sup>2</sup> Latch type relays should be initialized to a known position before using. Only the specified polarity should be used to energize the coil.

Double Coil Latch Type (at 20°C) <sup>2,3</sup>					
Nominal Coil Voltage (VDC)	Coil Resistance (Ω) ±10%		Set Voltage <sup>4</sup> (VDC)	Release Voltage <sup>4</sup> (VDC)	Nominal Operating Power (mW)
3	S	64.3	2.25	–	140
	R	64.3	–	2.25	
4.5	S	145	3.38	–	140
	R	145	–	3.38	
5	S	178	3.75	–	140
	R	178	–	3.75	
12	S	1028	9.0	–	140
	R	1028	–	9.0	
24	S	2880	18.0	–	200
	R	2880	–	18.0	

<sup>2</sup> Latch type relays should be initialized to a known position before using. Only the specified polarity should be used to energize the coil.

<sup>3</sup> Can not be driven by reverse polarity for reverse operation.

<sup>4</sup> S = Set coil [pin #1 (+), pin #12 (-)], R = Reset coil [pin #6 (+), pin #7 (-)].



## Coil Specifications cont'd

Non-latch, High Breakdown Voltage (NKX) Type (at 20°C)				
Nominal Coil Voltage (VDC)	Coil Resistance (Ω) ±10%	Operating Voltage <sup>1</sup> (VDC)	Release Voltage <sup>1</sup> (VDC)	Nominal Operating Power (mW)
3	39.1	2.25	0.3	230
4.5	88.0	3.38	0.45	230
12	626.0	9.0	1.2	230

<sup>1</sup> Test by pulse voltage.

## Recommended Relay Drive Conditions

Coil Type	Rating	Ambient Temperature
Non-latch	Voltage: ≤ ±5% of nominal voltage	-40 to +85°C
Single Coil Double Coil	Square pulse (rise and fall time is rapid) Pulse height: ≤ ±5% of nominal voltage Pulse Width: > 10 ms	

## Marking

### Top view



## Performance Data

### Coil Temperature Rise

Temperature is measured by coil resistance

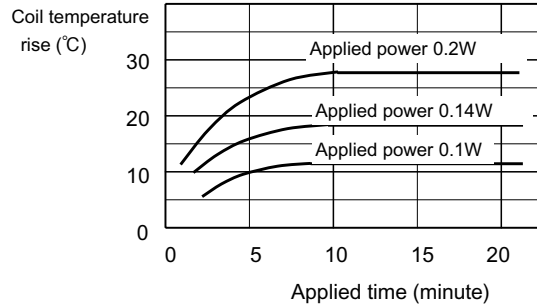

### Switching Capacity

Maximum Values

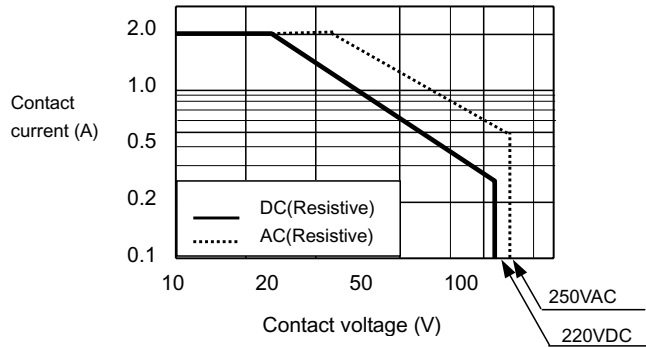

### Maximum Coil Voltage

Maximum value of permissible alteration

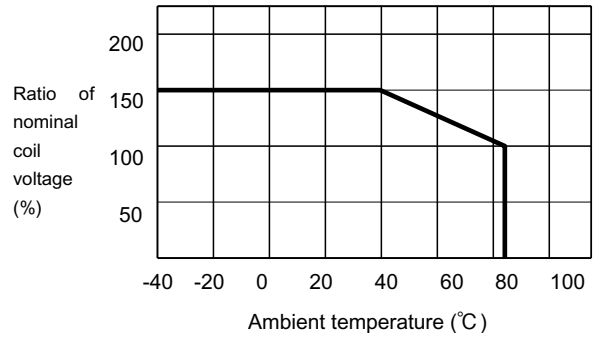

### Applied Voltage vs. Timing

(Sample: EE2-5NU)

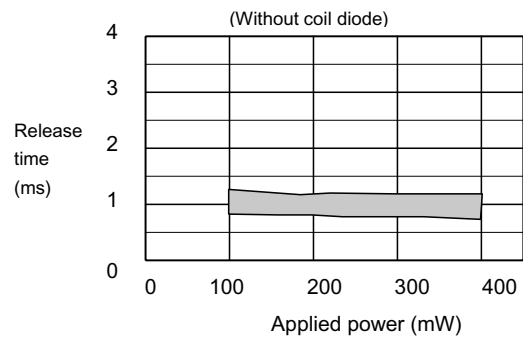
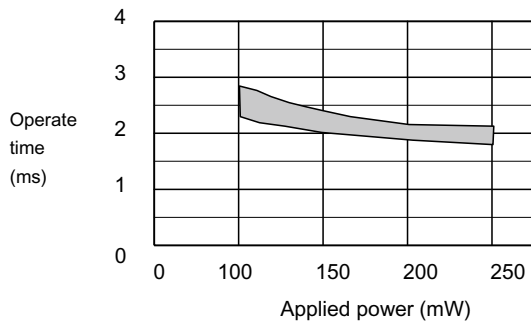

## Performance Data cont'd

### Operate and Release Voltage vs. Ambient Temperature

This shows a typical change of operate (release) voltage. The value of must operate is estimated, so coil voltage must be applied higher than this value for safe operation. For hot start operation, please inquire with KEMET.



### Running Test (Non-load)

(Load: none; Drive: 5 VDC, 50 Hz, 50% duty; Ambient Temperature: room temperature; Sample: EE2-5NU, 20 pieces)



### Running Test (Load)

(Load: 50 VDC, 0.1 A resistive; Drive: 5 VDC, 5 Hz, 50% duty; Ambient Temperature: 85°C; Sample: EE2-5NU, 10 pieces)



## Performance Data cont'd

### Breakdown Voltage

(Sample: EE2-5NU, 10 pieces)

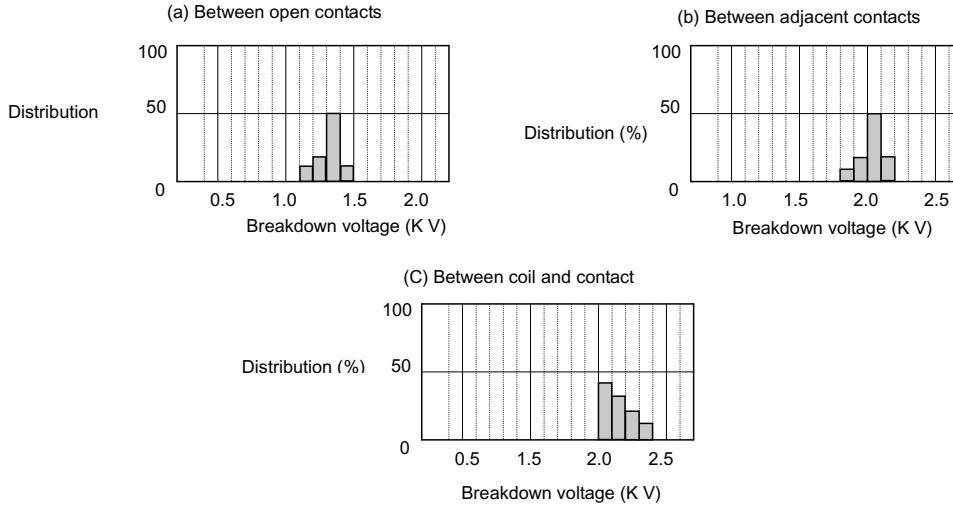

### Alteration of Voltage in Dense Mounting

(magnetic interference)

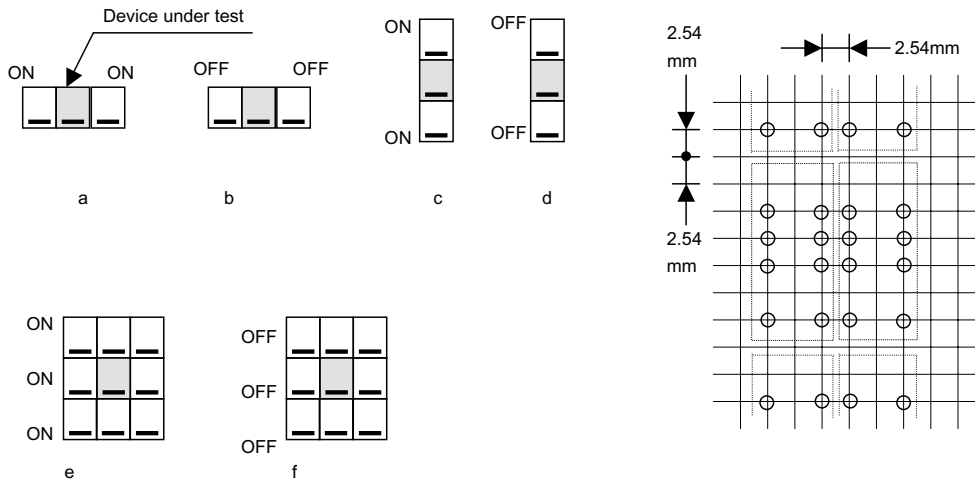
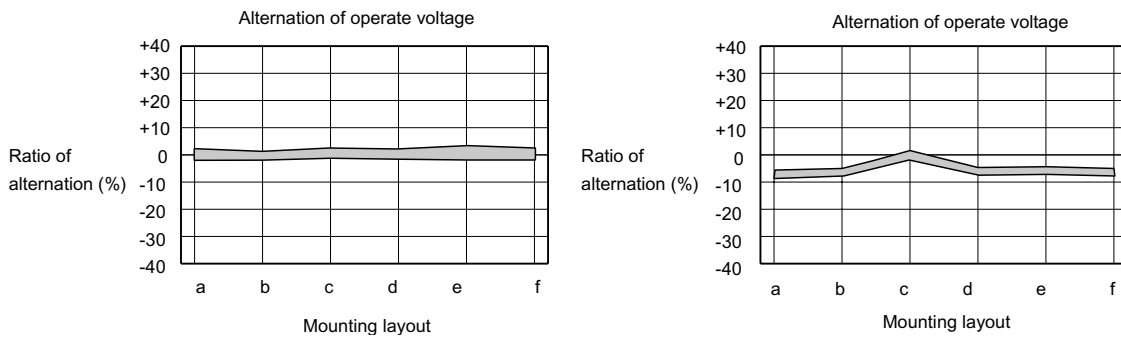

## Tube Packing – Millimeters

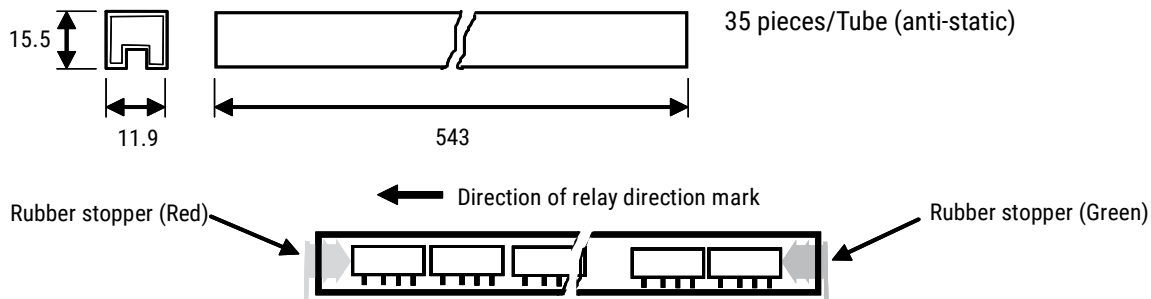

## Tape & Reel Packaging Information (EE2 only) – Millimeters

### Appearance

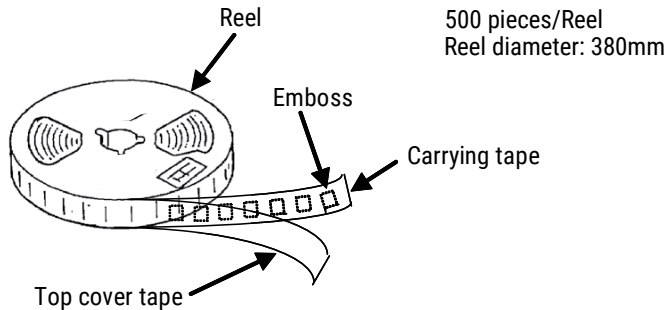

### Tape Dimensions

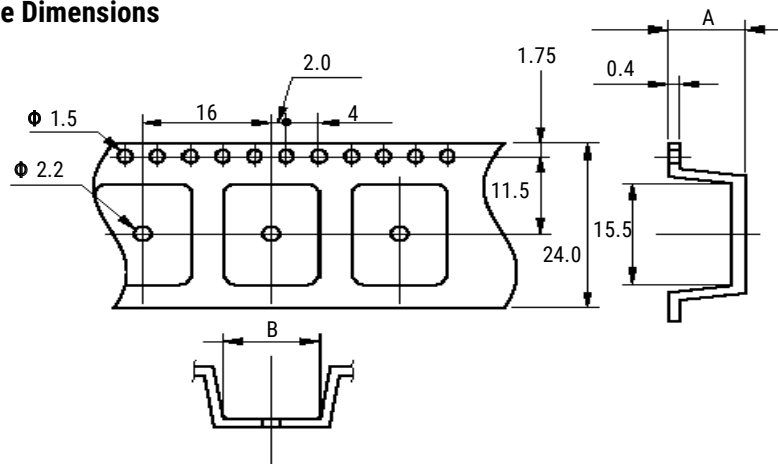

Series	A	B
NU-L, NUX-L, NKX-L	Maximum 10.9	10.0
NUH-L	Maximum 11.1	8.0

### Relay Direction Mark and Tape Carrying Direction

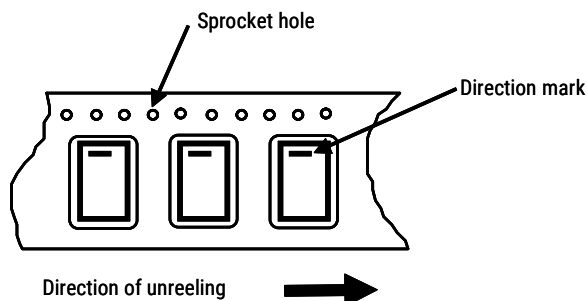

## Notes on Using Relays

### 1. Contact Load

Make sure that the contact load is within the specified range; otherwise, the lifetime of the contacts will be shortened considerably. Note that the running performance shown is an example, and that it varies depending on parameters such as the type of load, switching frequency, driver circuit, and ambient temperature under the actual operating conditions.

### 2. Driving Relays

- If the internal connection diagram of a relay shows + and - symbols on the coil, apply the rated voltage to the relay in the specified direction. If a rippled DC current source is used, abnormalities such as heat at the coil may occur.
- The maximum voltage that can be applied to the coil of the relay varies depending on the ambient temperature. Generally, the higher the voltage applied to the coil, the shorter the operating time. Note, however, that high voltage also increases the bounce of the contacts and the contact opening and closing frequency, which may shorten the lifetime of the contacts.

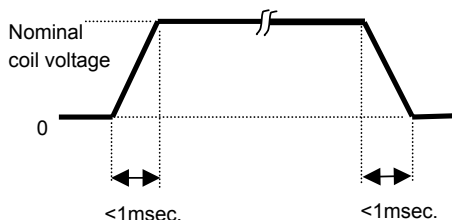

- For consistent operation, the driving voltage should have rise and fall times of less than 1 ms.
- For a latching relay, apply a voltage to the coil according to the polarity specified in the internal connection diagram of the relay.
- If a current is applied to the coil over a long period of time, the coil temperature rises, promoting generation of organic gas inside the relay, which may result in faulty contacts. In this case, use of a latching relay is recommended.
- The operating time and release time indicate the time required for each contact to close after the voltage has been applied to or removed from the coil. However, because the relay has a mechanical structure, a bounce state exists at the end of the operating and release times. Furthermore, because additional time is required until the contact stabilizes after being in a high-resistance state, care must be taken when using the relay at high speeds.

### 3. Operating Environment

- Make sure that the relay mounted in the application set is used within the specified temperature range. Use of a relay at a temperature outside this range may adversely affect insulation or contact performance.
- If the relay is used for a long period of time in highly humid (RH 85% or higher) environment, moisture may be absorbed into the relay. This moisture may react with the NO<sub>x</sub> and SO<sub>x</sub> generated by glow discharges that occur when the contacts are opened or closed, producing nitric or sulfuric acid. If this happens, the acid produced may corrode the metallic parts of the relay, causing operational malfunction.
- If any material containing silicon (silicon rubber, silicon oil, and silicon based coating material) is used in the neighborhood of relay, there is some possibility that these materials will emit silicon gas that will penetrate the relay. In this case, the switching contact may generate silicon compounds on the surface of contacts. This silicon compound may result in contact failure. Avoid use of relay in such an environment.

## Notes on Using Relays cont'd

- Because the operating temperature range varies depending on the humidity, use the relay in the temperature range illustrated in the figure below. Prevent the relay from being frozen and avoid the generation of condensation.

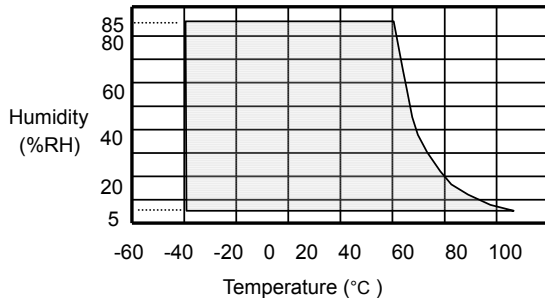

- The relay maintains constant sealability under normal atmospheric pressure (810 to 1,200 hpa). Its sealability may be degraded or the relay may be deformed and malfunction if it is used under barometric conditions exceeding the specified range.
- The same applies when the relay is stored or transported. Keep the upper-limit value of the temperature to which the relay is exposed after it is removed from the carton box to within 50°C.
- Permanent magnets are used in polarized relays. For this reason, when magnets, transformers, or speakers are located nearby the relay characteristics may change and faulty operations may result.
- If excessive vibration or shock is applied to the relay, it may malfunction and the contacts remain closed. Vibration or shock applied to the relay during operation may cause considerable damage to or wearing of the contacts. Note that operation of a snap switch mounted close to the relay or shock due to the operation of magnetic solenoid may also cause malfunctioning.

### 4. Mounting

- When mounting a relay onto a PC board using an automatic chip moulder, if excessive force is applied to the cover of the relay when the relay is chucked or inserted, the cover may be damaged or the characteristics of the relay degraded. Keep the force applied to the relay to within 1 kg.
- Avoid bending the pins to temporarily secure the relay to the PC board. Bending the pins may degrade sealability or adversely affect the internal mechanism.
- Ventilation immediately after soldering is recommended. Avoid immersing the relay in cleaning solvent immediately after soldering due to the danger of thermal shock being applied to the relay.
- Use an alcohol-based or water-based cleaning solvent. Never use thinner and benzene because they may damage the relay housing.
- Do not use ultrasonic cleaning because the vibration energy generated by the ultrasonic waves may cause the contacts to remain closed.

## Notes on Using Relays cont'd

### 5. Handling and Storage

- Relays are packaged in magazine cases for shipment. If a space is created in the case after some relays have been removed, be sure to insert a stopper to secure the remaining relays in the case. If relays are not well secured, vibration during transportation may cause malfunctioning of the contacts.
- Exercise care in handling the relay so as to avoid dropping it or allowing it to fall. Do not use a relay that has been dropped. If a relay drops from a workbench to the floor, a shock of 9,800 m/s<sup>2</sup> (1,000 G) or more is applied to the relay, possibly damaging its functions. Even if a light shock has been applied to the relay, thoroughly evaluate its operation before using it.
- Latching relays are factory-set to reset state for shipment. A latching relay may be set, however, by vibration or shock applied while being transported. Be sure to forcibly reset the relay before using it in the application set. Also note that the relay may be set by unexpected vibration or shock when it is used in a portable set.
- The sealability of a surface mount (SMT) relay may be lost if the relay absorbs and is then heated during soldering.

When storing relays, therefore, observe the following points:

1. For standard packing, please use relays within 12 months after delivery (storage conditions: 30°C/60% RH). If the relays have moisture absorption, dehumidify as follows:
  - Tape Packaging: 50 ±5°C, 200–300 hours.
  - Simple Relay: 85 ±5°C, 48 hours.
2. For MBB packing, please use relays within 2 years after delivery (storage conditions: 30°C/60% RH). After opening MBB packing, please use within 3 months (storage conditions: 30°C/60% RH).



## KEMET Electronics Corporation Sales Offices

For a complete list of our global sales offices, please visit [www.kemet.com/sales](http://www.kemet.com/sales).

---

### Disclaimer

All product specifications, statements, information and data (collectively, the "Information") in this datasheet are subject to change. The customer is responsible for checking and verifying the extent to which the Information contained in this publication is applicable to an order at the time the order is placed.

All Information given herein is believed to be accurate and reliable, but it is presented without guarantee, warranty, or responsibility of any kind, expressed or implied.

Statements of suitability for certain applications are based on KEMET Electronics Corporation's ("KEMET") knowledge of typical operating conditions for such applications, but are not intended to constitute – and KEMET specifically disclaims – any warranty concerning suitability for a specific customer application or use. The Information is intended for use only by customers who have the requisite experience and capability to determine the correct products for their application. Any technical advice inferred from this Information or otherwise provided by KEMET with reference to the use of KEMET's products is given gratis, and KEMET assumes no obligation or liability for the advice given or results obtained.

Although KEMET designs and manufactures its products to the most stringent quality and safety standards, given the current state of the art, isolated component failures may still occur. Accordingly, customer applications which require a high degree of reliability or safety should employ suitable designs or other safeguards (such as installation of protective circuitry or redundancies) in order to ensure that the failure of an electrical component does not result in a risk of personal injury or property damage.

Although all product-related warnings, cautions and notes must be observed, the customer should not assume that all safety measures are indicated or that other measures may not be required.

*KEMET is a registered trademark of KEMET Electronics Corporation.*



Компания «ЭлектроПласт» предлагает заключение долгосрочных отношений при поставках импортных электронных компонентов на взаимовыгодных условиях!

Наши преимущества:

- Оперативные поставки широкого спектра электронных компонентов отечественного и импортного производства напрямую от производителей и с крупнейших мировых складов;
- Поставка более 17-ти миллионов наименований электронных компонентов;
- Поставка сложных, дефицитных, либо снятых с производства позиций;
- Оперативные сроки поставки под заказ (от 5 рабочих дней);
- Экспресс доставка в любую точку России;
- Техническая поддержка проекта, помощь в подборе аналогов, поставка прототипов;
- Система менеджмента качества сертифицирована по Международному стандарту ISO 9001;
- Лицензия ФСБ на осуществление работ с использованием сведений, составляющих государственную тайну;
- Поставка специализированных компонентов (Xilinx, Altera, Analog Devices, Intersil, Interpoint, Microsemi, Aeroflex, Peregrine, Syfer, Eurofarad, Texas Instrument, Miteq, Cobham, E2V, MA-COM, Hittite, Mini-Circuits, General Dynamics и др.);

Помимо этого, одним из направлений компании «ЭлектроПласт» является направление «Источники питания». Мы предлагаем Вам помощь Конструкторского отдела:

- Подбор оптимального решения, техническое обоснование при выборе компонента;
- Подбор аналогов;
- Консультации по применению компонента;
- Поставка образцов и прототипов;
- Техническая поддержка проекта;
- Защита от снятия компонента с производства.



#### Как с нами связаться

**Телефон:** 8 (812) 309 58 32 (многоканальный)

**Факс:** 8 (812) 320-02-42

**Электронная почта:** [org@eplast1.ru](mailto:org@eplast1.ru)

**Адрес:** 198099, г. Санкт-Петербург, ул. Калинина, дом 2, корпус 4, литера А.