

4V Drive Nch+Nch MOS FET

SM6K2

●Structure

Silicon N-channel
MOSFET transistor

●Features

- 1) Two RHU002N06 chips in a SMT package.
- 2) Mounting possible with SMT3 automatic mounting machines.
- 3) Transistor elements are independent, eliminating mutual interference.
- 4) Mounting cost and area can be cut in half.

●External dimensions (Unit : mm)

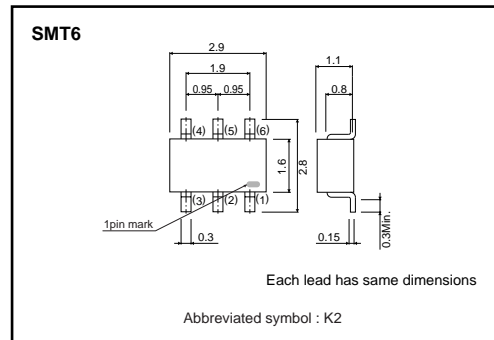

●Packaging specifications

	Package	Taping
	Code	T110
Type	Basic ordering unit (pieces)	3000
SM6K2		○

●Equivalent circuit

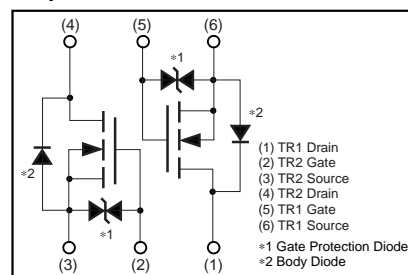

* A protection diode has been built in between the gate and the source to protect against static electricity when the product is in use.
Use the protection circuit when fixed voltages are exceeded.

●Absolute maximum ratings (Ta=25°C)

<It is the same ratings for the Tr1 and Tr2.>

Parameter	Symbol	Limits	Unit
Drain-source voltage	V _{DSS}	60	V
Gate-source voltage	V _{GSS}	±20	V
Drain current	Continuous	I _D	200 mA
	Pulsed	I _{DP} *1	800 mA
Drain reverse current	Continuous	I _{DR}	200 mA
	Pulsed	I _{DRP} *1	800 mA
Total power dissipation	P _D *2	300	mW / TOTAL
		200	mW / ELEMENT
Channel temperature	T _{ch}	150	°C
Storage temperature	T _{stg}	-55 to +150	°C

*1 P_{ws}≤10μs, Duty cycles≤1%

*2 With each pin mounted on the recommended lands.

●Thermal resistance

Parameter	Symbol	Limits	Unit
Channel to ambient	R _{th(ch-a)} *	416.7	°C / W / TOTAL
		625	°C / W / ELEMENT

* With each pin mounted on the recommended lands.

Transistors

●Electrical characteristics (Ta=25°C)

<It is the same characteristics for the Tr1 and Tr2.>

Parameter	Symbol	Min.	Typ.	Max.	Unit	Test Conditions
Gate leakage current	I _{GSS}	–	–	±10	μA	V _{GS} =±20V, V _{DS} =0V
Drain-source breakdown voltage	V _{(BR)DSS}	60	–	–	V	I _D =1mA, V _{GS} =0V
Drain cutoff current	I _{DSS}	–	–	1	μA	V _{DS} =60V, V _{GS} =0V
Gate threshold voltage	V _{GS(th)}	1	–	2.5	V	V _{DS} =10V, I _D =1mA
Drain-source on-state resistance	R _{DS(on)} *	–	1.7	2.4	Ω	I _D =200mA, V _{GS} =10V
		–	2.8	4.0		I _D =200mA, V _{GS} =4V
Forward transfer admittance	Y _{fs} *	0.1	–	–	S	V _{DS} =10V, I _D =200mA
Input capacitance	C _{iss}	–	15	–	pF	V _{DS} =10V
Output capacitance	C _{oss}	–	8	–	pF	V _{GS} =0V
Reverse transfer capacitance	C _{rss}	–	4	–	pF	f=1MHz
Turn-on delay time	t _{d(on)} *	–	6	–	ns	I _D =100mA, V _{DD} =30V
Rise time	t _r *	–	5	–	ns	V _{GS} =10V
Turn-off delay time	t _{d(off)} *	–	12	–	ns	R _L =300Ω
Fall time	t _f *	–	95	–	ns	R _G =10Ω
Total gate charge	Q _g *	–	2.2	4.4	nC	V _{DD} =30V
Gate-source charge	Q _{gs} *	–	0.6	–	nC	V _{GS} =10V
Gate-drain charge	Q _{gd} *	–	0.3	–	nC	I _D =200mA

* Pulsed

●Body diode characteristics (Source-drain) (Ta=25°C)

<It is the same characteristics for the Tr1 and Tr2.>

Parameter	Symbol	Min.	Typ.	Max.	Unit	Conditions
Forward voltage	V _{SD}	–	–	1.2	V	I _S =200mA, V _{GS} =0V

Transistors

●Electrical characteristic curves

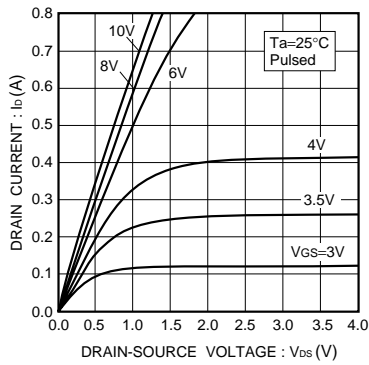

Fig.1 Typical output characteristics

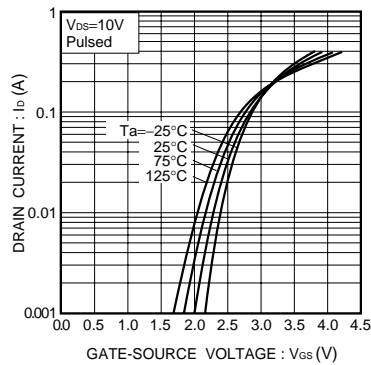

Fig.2 Typical transfer characteristics

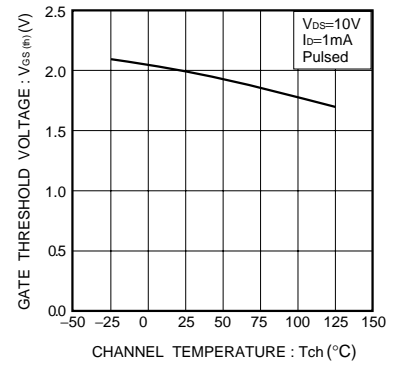

Fig.3 Gate threshold voltage vs. channel temperature

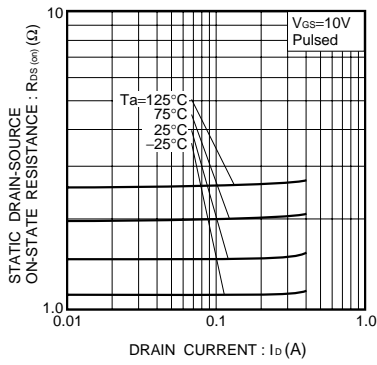

Fig.4 Static drain-source on-State resistance vs. drain current (I)

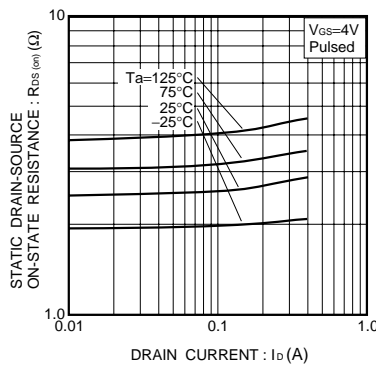

Fig.5 Static drain-source on-state resistance vs. drain current (II)

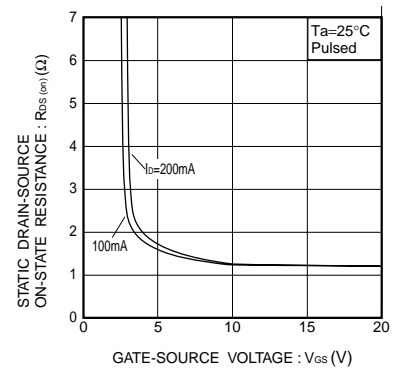

Fig.6 Static drain-source on-state resistance vs. gate-source voltage

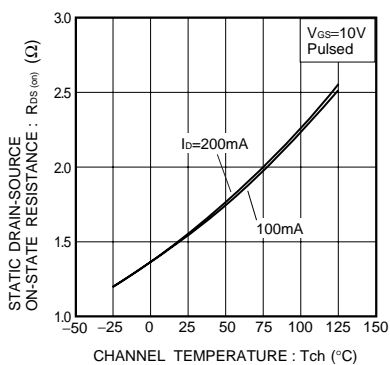

Fig.7 Static drain-source on-state resistance vs. channel temperature

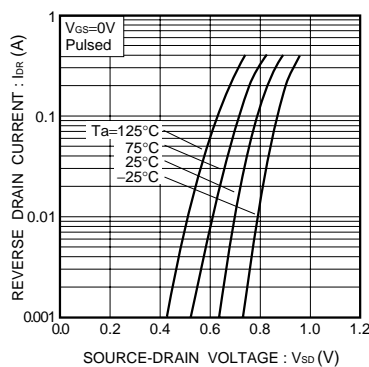

Fig.8 Reverse drain current vs. source-drain voltage (I)

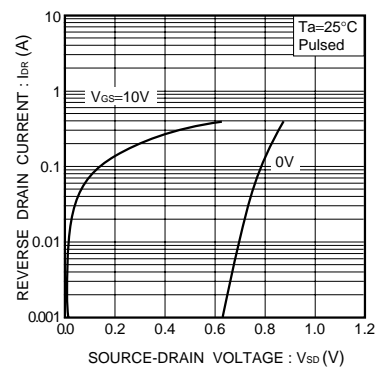

Fig.9 Reverse drain current vs. source-drain voltage (II)

Transistors

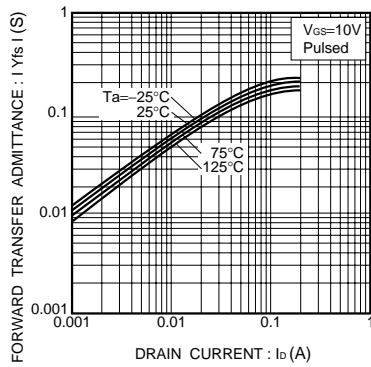

Fig.10 Forward transfer admittance vs. drain current

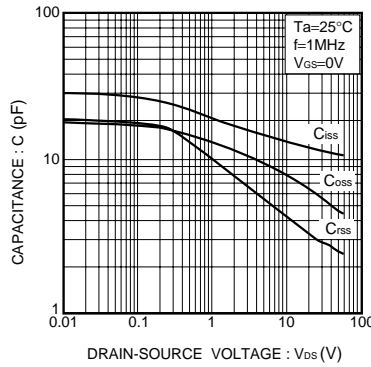

Fig.11 Typical capacitance vs. drain-source voltage

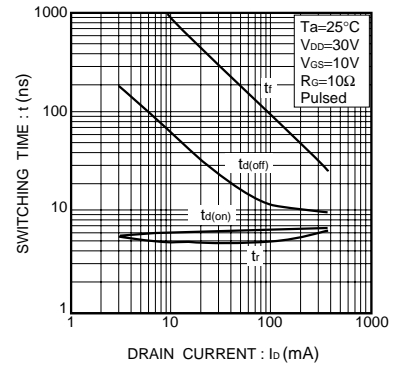

Fig.12 Switching characteristics

● Switching characteristics measurement circuit

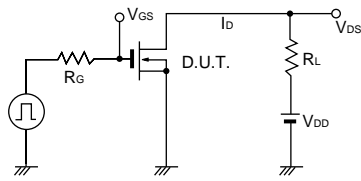

Fig.13 Switching time test circuit

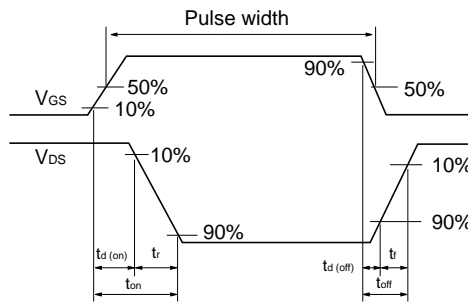

Fig.14 Switching time waveforms

Notes

- No technical content pages of this document may be reproduced in any form or transmitted by any means without prior permission of ROHM CO.,LTD.
- The contents described herein are subject to change without notice. The specifications for the product described in this document are for reference only. Upon actual use, therefore, please request that specifications to be separately delivered.
- Application circuit diagrams and circuit constants contained herein are shown as examples of standard use and operation. Please pay careful attention to the peripheral conditions when designing circuits and deciding upon circuit constants in the set.
- Any data, including, but not limited to application circuit diagrams information, described herein are intended only as illustrations of such devices and not as the specifications for such devices. ROHM CO.,LTD. disclaims any warranty that any use of such devices shall be free from infringement of any third party's intellectual property rights or other proprietary rights, and further, assumes no liability of whatsoever nature in the event of any such infringement, or arising from or connected with or related to the use of such devices.
- Upon the sale of any such devices, other than for buyer's right to use such devices itself, resell or otherwise dispose of the same, no express or implied right or license to practice or commercially exploit any intellectual property rights or other proprietary rights owned or controlled by
- ROHM CO., LTD. is granted to any such buyer.
- Products listed in this document are no antiradiation design.

The products listed in this document are designed to be used with ordinary electronic equipment or devices (such as audio visual equipment, office-automation equipment, communications devices, electrical appliances and electronic toys).

Should you intend to use these products with equipment or devices which require an extremely high level of reliability and the malfunction of which would directly endanger human life (such as medical instruments, transportation equipment, aerospace machinery, nuclear-reactor controllers, fuel controllers and other safety devices), please be sure to consult with our sales representative in advance.

About Export Control Order in Japan

Products described herein are the objects of controlled goods in Annex 1 (Item 16) of Export Trade Control Order in Japan.

In case of export from Japan, please confirm if it applies to "objective" criteria or an "informed" (by MITI clause) on the basis of "catch all controls for Non-Proliferation of Weapons of Mass Destruction.



Компания «ЭлектроПласт» предлагает заключение долгосрочных отношений при поставках импортных электронных компонентов на взаимовыгодных условиях!

Наши преимущества:

- Оперативные поставки широкого спектра электронных компонентов отечественного и импортного производства напрямую от производителей и с крупнейших мировых складов;
- Поставка более 17-ти миллионов наименований электронных компонентов;
- Поставка сложных, дефицитных, либо снятых с производства позиций;
- Оперативные сроки поставки под заказ (от 5 рабочих дней);
- Экспресс доставка в любую точку России;
- Техническая поддержка проекта, помощь в подборе аналогов, поставка прототипов;
- Система менеджмента качества сертифицирована по Международному стандарту ISO 9001;
- Лицензия ФСБ на осуществление работ с использованием сведений, составляющих государственную тайну;
- Поставка специализированных компонентов (Xilinx, Altera, Analog Devices, Intersil, Interpoint, Microsemi, Aeroflex, Peregrine, Syfer, Eurofarad, Texas Instrument, Miteq, Cobham, E2V, MA-COM, Hittite, Mini-Circuits, General Dynamics и др.);

Помимо этого, одним из направлений компании «ЭлектроПласт» является направление «Источники питания». Мы предлагаем Вам помощь Конструкторского отдела:

- Подбор оптимального решения, техническое обоснование при выборе компонента;
- Подбор аналогов;
- Консультации по применению компонента;
- Поставка образцов и прототипов;
- Техническая поддержка проекта;
- Защита от снятия компонента с производства.



Как с нами связаться

Телефон: 8 (812) 309 58 32 (многоканальный)

Факс: 8 (812) 320-02-42

Электронная почта: org@eplast1.ru

Адрес: 198099, г. Санкт-Петербург, ул. Калинина, дом 2, корпус 4, литера А.