

Notice for TAIYO YUDEN Products

[For High Quality and/or Reliability Equipment
(Automotive Electronic Equipment / Industrial Equipment)]

Please read this notice before using the TAIYO YUDEN products.

REMINDERS

- Product information in this catalog is as of October 2018. All of the contents specified herein are subject to change without notice due to technical improvements, etc. Therefore, please check for the latest information carefully before practical application or use of our products.

Please note that TAIYO YUDEN shall not be in any way responsible for any damages and defects in products or equipment incorporating our products, which are caused under the conditions other than those specified in this catalog or individual product specification sheets.

- Please contact TAIYO YUDEN for further details of product specifications as the individual product specification sheets are available.
- Please conduct validation and verification of our products in actual condition of mounting and operating environment before using our products.
- The products listed in this catalog are intended for use in general electronic equipment (e.g., AV equipment, OA equipment, home electric appliances, office equipment, information and communication equipment), medical equipment classified as Class I or II by IMDRF, industrial equipment, and automotive interior applications, etc. Please be sure to contact TAIYO YUDEN for further information before using the products for any equipment which may directly cause loss of human life or bodily injury (e.g., transportation equipment including, without limitation, automotive powertrain control system, train control system, and ship control system, traffic signal equipment, medical equipment classified as Class III by IMDRF).

Please do not incorporate our products into any equipment requiring high levels of safety and/or reliability (e.g., aerospace equipment, aviation equipment*, medical equipment classified as Class IV by IMDRF, nuclear control equipment, undersea equipment, military equipment).

*Note: There is a possibility that our products can be used only for aviation equipment that does not directly affect the safe operation of aircraft (e.g., in-flight entertainment, cabin light, electric seat, cooking equipment) if such use meets requirements specified separately by TAIYO YUDEN. Please be sure to contact TAIYO YUDEN for further information before using our products for such aviation equipment.

When our products are used even for high safety and/or reliability-required devices or circuits of general electronic equipment, it is strongly recommended to perform a thorough safety evaluation prior to use of our products and to install a protection circuit as necessary.

Please note that unless you obtain prior written consent of TAIYO YUDEN, TAIYO YUDEN shall not be in any way responsible for any damages incurred by you or third parties arising from use of the products listed in this catalog for any equipment requiring inquiry to TAIYO YUDEN or prohibited for use by TAIYO YUDEN as described above.

- Information contained in this catalog is intended to convey examples of typical performances and/or applications of our products and is not intended to make any warranty with respect to the intellectual property rights or any other related rights of TAIYO YUDEN or any third parties nor grant any license under such rights.
- Please note that the scope of warranty for our products is limited to the delivered our products themselves and TAIYO YUDEN shall not be in any way responsible for any damages resulting from a fault or defect in our products. Notwithstanding the foregoing, if there is a written agreement (e.g., supply and purchase agreement, quality assurance agreement) signed by TAIYO YUDEN and your company, TAIYO YUDEN will warrant our products in accordance with such agreement.
- The contents of this catalog are applicable to our products which are purchased from our sales offices or authorized distributors (hereinafter "TAIYO YUDEN's official sales channel"). Please note that the contents of this catalog are not applicable to our products purchased from any seller other than TAIYO YUDEN's official sales channel.

■ Caution for Export

Some of our products listed in this catalog may require specific procedures for export according to "U.S. Export Administration Regulations", "Foreign Exchange and Foreign Trade Control Law" of Japan, and other applicable regulations. Should you have any questions on this matter, please contact our sales staff.

Automotive Application Guide

We classify automotive electronic equipment into the following four application categories and set usable application categories for each of our products. When using our products for automotive electronic equipment, please be sure to check such application categories and use our products accordingly. Should you have any questions on this matter, please contact us.

| Category | Automotive Electronic Equipment (Typical Example) |
|----------------|---|
| POWERTRAIN | <ul style="list-style-type: none"> • Engine ECU (Electronically Controlled Fuel Injector) • Cruise Control Unit • 4WS (4 Wheel Steering) • Automatic Transmission • Power Steering • HEV/PHV/EV Core Control (Battery, Inverter, DC-DC) • Automotive Locator (Car location information providing device), etc. |
| SAFETY | <ul style="list-style-type: none"> • ABS (Anti-Lock Brake System) • ESC (Electronic Stability Control) • Airbag • ADAS (Equipment that directly controls running, turning and stopping), etc. |
| BODY & CHASSIS | <ul style="list-style-type: none"> • Wiper • Automatic Door • Power Window • Keyless Entry System • Electric Door Mirror • Interior Lighting • LED Headlight • TPMS (Tire Pressure Monitoring System) • Anti-Theft Device (Immobilizer), etc. |
| INFOTAINMENT | <ul style="list-style-type: none"> • Car Infotainment System • ITS/Telematics System • Instrument Cluster • ADAS (Sensor, Equipment that is not interlocked with safety equipment or powertrain), etc. |

MULTILAYER CHIP INDUCTORS(LK SERIES)

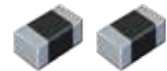

REFLOW
AEC-Q200

■ PART NUMBER

*Operating Temp. : -40~85°C

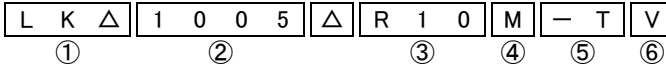

△=Blank space

①Series name

| Code | Series name |
|------|--------------------------|
| LK△ | Multilayer chip inductor |

②Dimensions (L×W)

| Code | Type (inch) | Dimensions (L×W) [mm] |
|------|-------------|-----------------------|
| 1005 | 1005 (0402) | 1.0×0.5 |

③Nominal inductance

| Code (example) | Nominal inductance [μH] |
|----------------|-------------------------|
| R12 | 0.12 |
| R22 | 0.22 |
| 1R0 | 1.0 |
| 2R2 | 2.2 |

※R=Decimal point

④Inductance tolerance

| Code | Inductance tolerance |
|------|----------------------|
| K | ±10% |
| M | ±20% |

⑤Packaging

| Code | Packaging |
|------|-----------|
| -T | Taping |

⑥Internal code

| Code | Internal code |
|------|------------------------------------|
| V | MLCI for Industrial and Automotive |

■ STANDARD EXTERNAL DIMENSIONS / STANDARD QUANTITY



| Type | L | W | T | e | Standard quantity [pcs] | |
|----------------|----------------------------|----------------------------|----------------------------|----------------------------|-------------------------|---------------|
| | | | | | Paper tape | Embossed tape |
| LK 1005 (0402) | 1.00±0.05 (0.039±0.002) | 0.50±0.05 (0.020±0.002) | 0.50±0.05 (0.020±0.002) | 0.25±0.10 (0.010±0.004) | 10000 | - |

Unit: mm (inch)

► This catalog contains the typical specification only due to the limitation of space. When you consider the purchase of our products, please check our product specification sheets. For details of each product (characteristics graph, reliability information, precautions for use, and so on), see our website (<http://www.ty-top.com/>).

■ PART NUMBER

• All the Multilayer Chip Inductors of the catalog lineup are RoHS compliant.

Note)

- The exchange of individual specifications is necessary depending on the application and circuit condition. Please contact Taiyo Yuden sales channels.
- *1: Automotive (AEC-Q200 Qualified) products for BODY & CHASSIS, and INFOTAINMENT. Please check "Automotive Application Guide" for further details before using the products.
 - < **AEC-Q200** : AEC-Q200 qualified >
 - All the Multilayer Chip Inductors of *1 marks are tested based on the test conditions and methods defined in AEC-Q200 by family item.
 - 85°C products: AEC-Q200 Grade3 (we conduct the evaluation at the test condition of Grade3.)
 - Please consult with TAIYO YUDEN's official sales channel for the details of the product specification and AEC-Q200 test results, etc., and please review and approve TAIYO YUDEN's product specification before ordering.
- *2: Industrial products and Medical products

● LK1005

| Part number | Nominal inductance [μH] | Inductance tolerance | Q (min.) | Self-resonant frequency [MHz] (min.) | DC Resistance [Ω] (max.) | Rated current [mA] (max.) | Measuring frequency [MHz] | Thickness [mm] | Note |
|-----------------|-------------------------|----------------------|----------|--------------------------------------|--------------------------|---------------------------|---------------------------|----------------|-------|
| LK 1005 R12□-TV | 0.12 | ±10%, ±20% | 10 | 180 | 0.59 | 25 | 25 | 0.50 ±0.05 | *1,*2 |
| LK 1005 R15□-TV | 0.15 | ±10%, ±20% | 10 | 165 | 0.63 | 25 | 25 | 0.50 ±0.05 | *1,*2 |
| LK 1005 R18□-TV | 0.18 | ±10%, ±20% | 10 | 150 | 0.76 | 25 | 25 | 0.50 ±0.05 | *1,*2 |
| LK 1005 R22□-TV | 0.22 | ±10%, ±20% | 10 | 135 | 0.79 | 25 | 25 | 0.50 ±0.05 | *1,*2 |
| LK 1005 R27□-TV | 0.27 | ±10%, ±20% | 10 | 120 | 0.91 | 25 | 25 | 0.50 ±0.05 | *1,*2 |
| LK 1005 R33□-TV | 0.33 | ±10%, ±20% | 10 | 105 | 1.05 | 25 | 25 | 0.50 ±0.05 | *1,*2 |
| LK 1005 R39□-TV | 0.39 | ±10%, ±20% | 20 | 85 | 0.41 | 20 | 10 | 0.50 ±0.05 | *1,*2 |
| LK 1005 R47□-TV | 0.47 | ±10%, ±20% | 20 | 80 | 0.42 | 20 | 10 | 0.50 ±0.05 | *1,*2 |
| LK 1005 R56□-TV | 0.56 | ±10%, ±20% | 20 | 75 | 0.47 | 20 | 10 | 0.50 ±0.05 | *1,*2 |
| LK 1005 R68□-TV | 0.68 | ±10%, ±20% | 20 | 70 | 0.55 | 20 | 10 | 0.50 ±0.05 | *1,*2 |
| LK 1005 R82□-TV | 0.82 | ±10%, ±20% | 20 | 65 | 0.59 | 20 | 10 | 0.50 ±0.05 | *1,*2 |
| LK 1005 R10□-TV | 1.0 | ±10%, ±20% | 20 | 60 | 0.64 | 20 | 10 | 0.50 ±0.05 | *1,*2 |
| LK 1005 R12□-TV | 1.2 | ±10%, ±20% | 20 | 55 | 0.79 | 20 | 10 | 0.50 ±0.05 | *1,*2 |
| LK 1005 R15□-TV | 1.5 | ±10%, ±20% | 20 | 50 | 0.95 | 20 | 10 | 0.50 ±0.05 | *1,*2 |
| LK 1005 R18□-TV | 1.8 | ±10%, ±20% | 20 | 45 | 1.16 | 20 | 10 | 0.50 ±0.05 | *1,*2 |
| LK 1005 R22□-TV | 2.2 | ±10%, ±20% | 20 | 40 | 1.15 | 20 | 10 | 0.50 ±0.05 | *1,*2 |

※ □ mark indicates the Inductance tolerance code.

※) The rated current is either the DC value at which the internal L value is decreased within 5% with the application of DC bias, or the value of current at which the temperature of the element is increased within 20°C.

■ Derating of Rated Current

- LK series
Until 85 °C ambient temperature, LK series is available at 100% of the rated current. Please refer to the chart shown below.

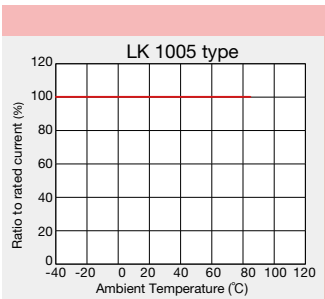

▶ This catalog contains the typical specification only due to the limitation of space. When you consider the purchase of our products, please check our product specification sheets. For details of each product (characteristics graph, reliability information, precautions for use, and so on), see our website (<http://www.ty-top.com/>).

Multilayer chip inductors

Multilayer chip inductors for high frequency, Multilayer chip bead inductors

Multilayer common mode choke coils (MC series F type)

Metal Multilayer Chip Power Inductors (MCOIL™ MC series)

PACKAGING

① Minimum Quantity

● Tape & Reel Packaging

| Type | Thickness mm (inch) | Standard Quantity [pcs] | |
|----------------|------------------------|-------------------------|---------------|
| | | Paper Tape | Embossed Tape |
| CK1608(0603) | 0.8 (0.031) | 4000 | — |
| CK2125(0805) | 0.85(0.033) | 4000 | — |
| | 1.25(0.049) | — | 2000 |
| CKS2125(0805) | 0.85(0.033) | 4000 | — |
| | 1.25(0.049) | — | 2000 |
| CKP1608(0603) | 0.8 (0.031) | 4000 | — |
| CKP2012(0805) | 0.9 (0.035) | — | 3000 |
| CKP2016(0806) | 0.9 (0.035) | — | 3000 |
| CKP2520(1008) | 0.7 (0.028) | — | 3000 |
| | 0.9 (0.035) | — | 3000 |
| | 1.1 (0.043) | — | 2000 |
| LK1005(0402) | 0.5 (0.020) | 10000 | — |
| LK1608(0603) | 0.8 (0.031) | 4000 | — |
| LK2125(0805) | 0.85(0.033) | 4000 | — |
| | 1.25(0.049) | — | 2000 |
| HK0603(0201) | 0.3 (0.012) | 15000 | — |
| HK1005(0402) | 0.5 (0.020) | 10000 | — |
| HK1608(0603) | 0.8 (0.031) | 4000 | — |
| HK2125(0805) | 0.85(0.033) | — | 4000 |
| | 1.0 (0.039) | — | 3000 |
| HKQ0603W(0201) | 0.3 (0.012) | 15000 | — |
| HKQ0603S(0201) | 0.3 (0.012) | 15000 | — |
| HKQ0603U(0201) | 0.3 (0.012) | 15000 | — |
| AQ105(0402) | 0.5 (0.020) | 10000 | — |
| BK0603(0201) | 0.3 (0.012) | 15000 | — |
| BK1005(0402) | 0.5 (0.020) | 10000 | — |
| BKH0603(0201) | 0.3 (0.012) | 15000 | — |
| BKH1005(0402) | 0.5 (0.020) | 10000 | — |
| BK1608(0603) | 0.8 (0.031) | 4000 | — |
| BK2125(0805) | 0.85(0.033) | 4000 | — |
| | 1.25(0.049) | — | 2000 |
| BK2010(0804) | 0.45(0.018) | 4000 | — |
| BK3216(1206) | 0.8 (0.031) | — | 4000 |
| BKP0603(0201) | 0.3 (0.012) | 15000 | — |
| BKP1005(0402) | 0.5 (0.020) | 10000 | — |
| BKP1608(0603) | 0.8 (0.031) | 4000 | — |
| BKP2125(0805) | 0.85(0.033) | 4000 | — |
| MCF0605(0202) | 0.3 (0.012) | 15000 | — |
| MCF0806(0302) | 0.4 (0.016) | — | 10000 |
| MCF1210(0504) | 0.55(0.022) | — | 5000 |
| MCF2010(0804) | 0.45(0.018) | — | 4000 |
| MCEE1005(0402) | 0.55(0.022) | 10000 | — |
| MCFK1608(0603) | 0.6 (0.024) | 4000 | — |
| MCFE1608(0603) | 0.65(0.026) | 4000 | — |
| MCKK1608(0603) | 1.0 (0.039) | — | 3000 |
| MCHK2012(0806) | 0.8 (0.031) | 4000 | — |
| MCKK2012(0805) | 1.0 (0.039) | — | 3000 |

▶ This catalog contains the typical specification only due to the limitation of space. When you consider the purchase of our products, please check our specification. For details of each product (characteristics graph, reliability information, precautions for use, and so on), see our Web site (<http://www.ty-top.com/>).

② Taping material

● Card board carrier tape

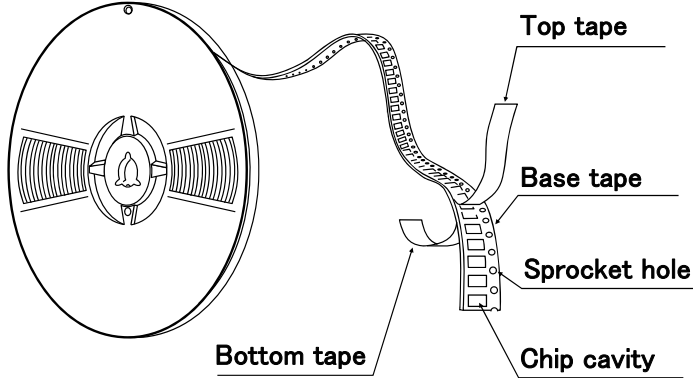

| | |
|-----|------|
| CK | 1608 |
| CKP | 1608 |
| CK | 2125 |
| CKS | 2125 |
| LK | 1005 |
| LK | 1608 |
| LK | 2125 |
| HK | 0603 |
| HK | 1005 |
| HK | 1608 |
| HKQ | 0603 |
| AQ | 105 |

| | |
|-----|------|
| BK | 0603 |
| BK | 1005 |
| BK | 1608 |
| BK | 2125 |
| BK | 2010 |
| BKP | 0603 |
| BKP | 1005 |
| BKP | 1608 |
| BKP | 2125 |
| BKH | 0603 |
| BKH | 1005 |
| MCF | 0605 |
| MC | 1005 |
| MC | 1608 |
| MC | 2012 |

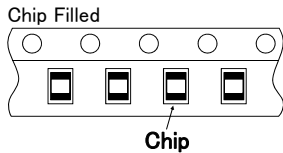

● Embossed Tape

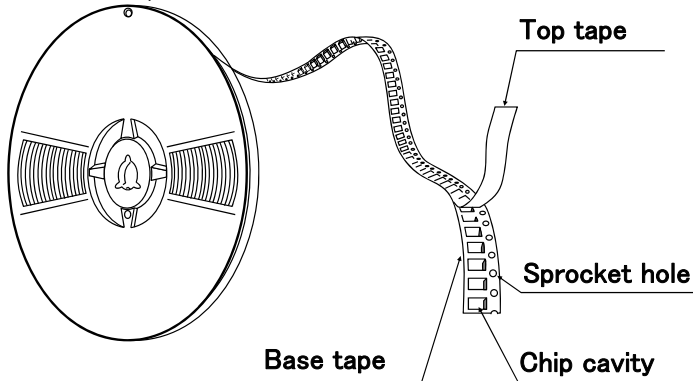

| | |
|-----|------|
| CK | 2125 |
| CKS | 2125 |
| CKP | 2012 |
| CKP | 2016 |
| CKP | 2520 |
| LK | 2125 |
| HK | 2125 |

| | |
|-----|------|
| BK | 2125 |
| BK | 3216 |
| MCF | 0806 |
| MCF | 1210 |
| MCF | 2010 |
| MC | 1608 |
| MC | 2012 |



③ Taping Dimensions

● Paper tape (8mm wide)

Unit: mm (inch)



▶ This catalog contains the typical specification only due to the limitation of space. When you consider the purchase of our products, please check our specification. For details of each product (characteristics graph, reliability information, precautions for use, and so on), see our Web site (<http://www.ty-top.com/>).

| Type | Thickness mm (inch) | Chip cavity | | Insertion Pitch | Tape Thickness |
|----------------|------------------------|----------------------------|----------------------------|---------------------------|-----------------------|
| | | A | B | F | T |
| CK1608(0603) | 0.8 (0.031) | 1.0±0.2 (0.039±0.008) | 1.8±0.2 (0.071±0.008) | 4.0±0.1 (0.157±0.004) | 1.1max (0.043max) |
| CK2125(0805) | 0.85(0.033) | 1.5±0.2 (0.059±0.008) | 2.3±0.2 (0.091±0.008) | 4.0±0.1 (0.157±0.004) | 1.1max (0.043max) |
| CKS2125(0805) | 0.85(0.033) | 1.5±0.2 (0.059±0.008) | 2.3±0.2 (0.091±0.008) | 4.0±0.1 (0.157±0.004) | 1.1max (0.043max) |
| CKP1608(0603) | 0.8 (0.031) | 1.0±0.2 (0.039±0.008) | 1.8±0.2 (0.071±0.008) | 4.0±0.1 (0.157±0.004) | 1.1max (0.043max) |
| LK1005(0402) | 0.5 (0.020) | 0.65±0.1 (0.026±0.004) | 1.15±0.1 (0.045±0.004) | 2.0±0.05 (0.079±0.002) | 0.8max (0.031max) |
| LK1608(0603) | 0.8 (0.031) | 1.0±0.2 (0.039±0.008) | 1.8±0.2 (0.071±0.008) | 4.0±0.1 (0.157±0.004) | 1.1max (0.043max) |
| LK2125(0805) | 0.85(0.033) | 1.5±0.2 (0.059±0.008) | 2.3±0.2 (0.091±0.008) | 4.0±0.1 (0.157±0.004) | 1.1max (0.043max) |
| HK0603(0201) | 0.3 (0.012) | 0.40±0.06 (0.016±0.002) | 0.70±0.06 (0.028±0.002) | 2.0±0.05 (0.079±0.002) | 0.45max (0.018max) |
| HK1005(0402) | 0.5 (0.020) | 0.65±0.1 (0.026±0.004) | 1.15±0.1 (0.045±0.004) | 2.0±0.05 (0.079±0.002) | 0.8max (0.031max) |
| HK1608(0603) | 0.8 (0.031) | 1.0±0.2 (0.039±0.008) | 1.8±0.2 (0.071±0.008) | 4.0±0.1 (0.157±0.004) | 1.1max (0.043max) |
| HKQ0603W(0201) | 0.3 (0.012) | 0.40±0.06 (0.016±0.002) | 0.70±0.06 (0.028±0.002) | 2.0±0.05 (0.079±0.002) | 0.45max (0.018max) |
| HKQ0603S(0201) | 0.3 (0.012) | 0.40±0.06 (0.016±0.002) | 0.70±0.06 (0.028±0.002) | 2.0±0.05 (0.079±0.002) | 0.45max (0.018max) |
| HKQ0603U(0201) | 0.3 (0.012) | 0.40±0.06 (0.016±0.002) | 0.70±0.06 (0.028±0.002) | 2.0±0.05 (0.079±0.002) | 0.45max (0.018max) |
| AQ105(0402) | 0.5 (0.020) | 0.75±0.1 (0.030±0.004) | 1.15±0.1 (0.045±0.004) | 2.0±0.05 (0.079±0.002) | 0.8max (0.031max) |
| BK0603(0201) | 0.3 (0.012) | 0.40±0.06 (0.016±0.002) | 0.70±0.06 (0.028±0.002) | 2.0±0.05 (0.079±0.002) | 0.45max (0.018max) |
| BK1005(0402) | 0.5 (0.020) | 0.65±0.1 (0.026±0.004) | 1.15±0.1 (0.045±0.004) | 2.0±0.05 (0.079±0.002) | 0.8max (0.031max) |
| BK1608(0603) | 0.8 (0.031) | 1.0±0.2 (0.039±0.008) | 1.8±0.2 (0.071±0.008) | 4.0±0.1 (0.157±0.004) | 1.1max (0.043max) |
| BK2125(0805) | 0.85(0.033) | 1.5±0.2 (0.059±0.008) | 2.3±0.2 (0.091±0.008) | 4.0±0.1 (0.157±0.004) | 1.1max (0.043max) |
| BK2010(0804) | 0.45(0.018) | 1.2±0.1 (0.047±0.004) | 2.17±0.1 (0.085±0.004) | 4.0±0.1 (0.157±0.004) | 0.8max (0.031max) |
| BKP0603(0201) | 0.3 (0.012) | 0.40±0.06 (0.016±0.002) | 0.70±0.06 (0.028±0.002) | 2.0±0.05 (0.079±0.002) | 0.45max (0.018max) |
| BKP1005(0402) | 0.5 (0.020) | 0.65±0.1 (0.026±0.004) | 1.15±0.1 (0.045±0.004) | 2.0±0.05 (0.079±0.002) | 0.8max (0.031max) |
| BKP1608(0603) | 0.8 (0.031) | 1.0±0.2 (0.039±0.008) | 1.8±0.2 (0.071±0.008) | 4.0±0.1 (0.157±0.004) | 1.1max (0.043max) |
| BKP2125(0805) | 0.85(0.033) | 1.5±0.2 (0.059±0.008) | 2.3±0.2 (0.091±0.008) | 4.0±0.1 (0.157±0.004) | 1.1max (0.043max) |
| BKH0603(0201) | 0.3 (0.012) | 0.40±0.06 (0.016±0.002) | 0.70±0.06 (0.028±0.002) | 2.0±0.05 (0.079±0.002) | 0.45max (0.018max) |
| BKH1005(0402) | 0.5 (0.020) | 0.65±0.1 (0.026±0.004) | 1.15±0.1 (0.045±0.004) | 2.0±0.05 (0.079±0.002) | 0.8max (0.031max) |
| MCF0605(0202) | 0.3 (0.012) | 0.62±0.03 (0.024±0.001) | 0.77±0.03 (0.030±0.001) | 2.0±0.05 (0.079±0.002) | 0.45max (0.018max) |
| MCFK1608(0603) | 0.6 (0.024) | 1.1±0.05 (0.043±0.002) | 1.9±0.05 (0.075±0.002) | 4.0±0.1 (0.157±0.004) | 0.72max (0.028max) |
| MCEE1005(0402) | 0.55(0.021) | 0.8±0.05 (0.031±0.002) | 1.3±0.05 (0.051±0.002) | 2.0±0.05 (0.079±0.002) | 0.6max (0.016max) |
| MCFE1608(0603) | 0.65(0.026) | 1.1±0.05 (0.043±0.002) | 1.9±0.05 (0.075±0.002) | 4.0±0.1 (0.157±0.004) | 0.9max (0.035max) |
| MCHK2012(0805) | 0.8 (0.031) | 1.55±0.2 (0.061±0.008) | 2.3±0.2 (0.091±0.008) | 4.0±0.1 (0.157±0.004) | 0.9max (0.035max) |

Unit : mm (inch)

● Embossed Tape (8mm wide)



| Type | Thickness mm (inch) | Chip cavity | | Insertion Pitch | Tape Thickness | |
|-----------------|------------------------|--------------------------------|--------------------------------|-------------------------------|-----------------|-----------------|
| | | A | B | F | K | T |
| CK2125 (0805) | 1.25 (0.049) | 1.5 ± 0.2 (0.059 ± 0.008) | 2.3 ± 0.2 (0.091 ± 0.008) | 4.0 ± 0.1 (0.157 ± 0.004) | 2.0 (0.079) | 0.3 (0.012) |
| CKS2125 (0805) | 1.25 (0.049) | 1.5 ± 0.2 (0.059 ± 0.008) | 2.3 ± 0.2 (0.091 ± 0.008) | 4.0 ± 0.1 (0.157 ± 0.004) | 2.0 (0.079) | 0.3 (0.012) |
| CKP2012 (0805) | 0.9 (0.035) | 1.55 ± 0.2 (0.061 ± 0.008) | 2.3 ± 0.2 (0.091 ± 0.008) | 4.0 ± 0.1 (0.157 ± 0.004) | 1.3 (0.051) | 0.3 (0.012) |
| CKP2016 (0806) | 0.9 (0.035) | 1.8 ± 0.1 (0.071 ± 0.004) | 2.2 ± 0.1 (0.087 ± 0.004) | 4.0 ± 0.1 (0.157 ± 0.004) | 1.3 (0.051) | 0.25 (0.01) |
| CKP2520 (1008) | 0.7 (0.028) | 2.3 ± 0.1 (0.091 ± 0.004) | 2.8 ± 0.1 (0.110 ± 0.004) | 4.0 ± 0.1 (0.157 ± 0.004) | 1.4 (0.055) | 0.3 (0.012) |
| | 0.9 (0.035) | | | | 1.4 (0.055) | |
| | 1.1 (0.043) | | | | 1.7 (0.067) | |
| | 1.1 (0.043) | | | | 1.7 (0.067) | |
| LK2125 (0805) | 1.25 (0.049) | 1.5 ± 0.2 (0.059 ± 0.008) | 2.3 ± 0.2 (0.091 ± 0.008) | 4.0 ± 0.1 (0.157 ± 0.004) | 2.0 (0.079) | 0.3 (0.012) |
| HK2125 (0805) | 0.85 (0.033) | 1.5 ± 0.2 (0.059 ± 0.008) | 2.3 ± 0.2 (0.091 ± 0.008) | 4.0 ± 0.1 (0.157 ± 0.004) | 1.5 (0.059) | 0.3 (0.012) |
| | 1.0 (0.039) | | | | 2.0 (0.079) | |
| BK2125 (0805) | 1.25 (0.049) | 1.5 ± 0.2 (0.059 ± 0.008) | 2.3 ± 0.2 (0.091 ± 0.008) | 4.0 ± 0.1 (0.157 ± 0.004) | 2.0 (0.079) | 0.3 (0.012) |
| BK3216 (1206) | 0.8 (0.031) | 1.9 ± 0.1 (0.075 ± 0.004) | 3.5 ± 0.1 (0.138 ± 0.004) | 4.0 ± 0.1 (0.157 ± 0.004) | 1.4 (0.055) | 0.3 (0.012) |
| MCF0806 (0302) | 0.4 (0.016) | 0.75 ± 0.05 (0.030 ± 0.002) | 0.95 ± 0.05 (0.037 ± 0.002) | 2.0 ± 0.05 (0.079 ± 0.002) | 0.55 (0.022) | 0.3 (0.012) |
| MCF1210 (0504) | 0.55 (0.022) | 1.15 ± 0.05 (0.045 ± 0.002) | 1.40 ± 0.05 (0.055 ± 0.002) | 4.0 ± 0.1 (0.157 ± 0.004) | 0.65 (0.026) | 0.3 (0.012) |
| MCF2010 (0804) | 0.45 (0.018) | 1.1 ± 0.1 (0.043 ± 0.004) | 2.3 ± 0.1 (0.091 ± 0.004) | 4.0 ± 0.1 (0.157 ± 0.004) | 0.85 (0.033) | 0.3 (0.012) |
| MCKK1608 (0603) | 1.0 (0.039) | 1.1 ± 0.1 (0.043 ± 0.004) | 1.95 ± 0.1 (± 0.004) | 4.0 ± 0.1 (0.157 ± 0.004) | 1.4 (0.055) | 0.25 (0.01) |
| MCKK2012 (0805) | 1.0 (0.039) | 1.55 ± 0.2 (0.061 ± 0.008) | 2.3 ± 0.2 (0.091 ± 0.008) | 4.0 ± 0.1 (0.157 ± 0.004) | 1.35 (0.053) | 0.25 (0.010) |

Unit : mm (inch)

④ LEADER AND BLANK PORTION



⑤ Reel Size



| A | B | C | D | E | R |
|--------------------|-------------------|---------------------|---------------------|---------------|-----|
| $\phi 178 \pm 2.0$ | $\phi 60$ or more | $\phi 13.0 \pm 0.2$ | $\phi 21.0 \pm 0.8$ | 2.0 ± 0.5 | 1.0 |

| | t | W |
|----------------|---------|--------------|
| 4mm width tape | 1.5max. | 5 ± 1.0 |
| 8mm width tape | 2.5max. | 10 ± 1.5 |

(Unit : mm)

⑥ Top tape strength

The top tape requires a peel-off force of 0.1~0.7N in the direction of the arrow as illustrated below.



Multilayer chip inductors

Multilayer chip inductors for high frequency, Multilayer chip bead inductors

RELIABILITY DATA

| 1. Operating Temperature Range | | |
|--------------------------------|---|---|
| Specified Value | BK series | -55~+125°C |
| | BKP series | -55~+125°C (Including self-generated heat) |
| | LK series | -40~+85°C |
| | HK series | -55~+125°C |
| 2. Storage Temperature Range | | |
| Specified Value | BK series | -55~+125°C |
| | BKP series | -55~+125°C |
| | LK series | -40~+85°C |
| | HK series | -55~+125°C |
| 3. Rated Current | | |
| Specified Value | BK series | The temperature of the element is increased within 20°C. |
| | BKP series | The temperature of the element is increased within 40°C |
| | LK series | The decreasing-rate of inductance value is within 5 % |
| | HK series | The decreasing-rate of inductance value is within 5 %, or the temperature of the element is increased within 20°C |
| 4. Impedance | | |
| Specified Value | BK series | Refer to each specification. |
| | BKP series | |
| | LK series | |
| | HK series | |
| Test Methods and Remarks | Measuring frequency : 100±1MHz Measuring equipment : 4291A (or its equivalent) Measuring jig : 16192A (or its equivalent), HW:16193A (or its equivalent) | |
| 5. Inductance | | |
| Specified Value | BK series | Refer to each specification. |
| | BKP series | |
| | LK series | |
| | HK series | |
| Test Methods and Remarks | LK Series Measuring frequency : 10~25MHz Measuring equipment /jig : 4291A+16193A (or its equivalent) Measuring current : 1mA rms HK Series Measuring frequency : 100MHz Measuring equipment /jig : 4291A+16193A (or its equivalent) | |
| 6. Q | | |
| Specified Value | BK series | Refer to each specification. |
| | BKP series | |
| | LK series | |
| | HK series | |
| Test Methods and Remarks | LK Series Measuring frequency : Refer to each specification. Measuring equipment /jig : 4291A+16193A (or its equivalent) Measuring current : 1mA rms HK Series Measuring frequency : 100MHz Measuring equipment /jig : 4291A+16193A (or its equivalent) | |
| 7. DC Resistance | | |
| Specified Value | BK series | Refer to each specification. |
| | BKP series | |
| | LK series | |
| | HK series | |
| Test Methods and Remarks | Measuring equipment : VOAC-7412, VOAC-7512, VOAC-7521 (made by Iwasaki Tsushinki) | |

▶ This catalog contains the typical specification only due to the limitation of space. When you consider the purchase of our products, please check our specification. For details of each product (characteristics graph, reliability information, precautions for use, and so on), see our Web site (<http://www.ty-top.com/>).

| 8. Self Resonance Frequency (SRF) | | |
|-----------------------------------|--|---|
| Specified Value | BK series | — |
| | BKP series | |
| | LK series | |
| | HK series | |
| Refer to each specification. | | |
| Test Methods and Remarks | LK Series Measuring equipment : 4195A (or its equivalent) Measuring jig : 41951 + 16092A (or its equivalent) HK Series : Measuring equipment : 8719C (or its equivalent) | |

| 9. Temperature Characteristic | | |
|--------------------------------------|---|---|
| Specified Value | BK series | — |
| | BKP series | |
| | LK series | |
| | HK series | |
| Inductance change: Within $\pm 10\%$ | | |
| Test Methods and Remarks | Temperature range : $-30 \sim +85^{\circ}\text{C}$ Reference temperature : $+20^{\circ}\text{C}$ | |

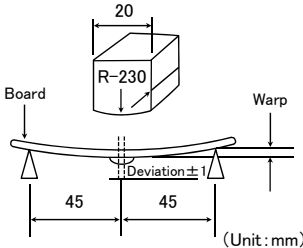
| 10. Resistance to Flexure of Substrate | | |
|--|--|-----------------------|
| Specified Value | BK series | No mechanical damage. |
| | BKP series | |
| | LK series | |
| | HK series | |
| Test Methods and Remarks | Warp : 2mm Testing board : glass epoxy-resin substrate Thickness : 0.8mm  | |

| 11. Solderability | | |
|--------------------------|--|--|
| Specified Value | BK series | At least 90% of terminal electrode is covered by new solder. |
| | BKP series | |
| | LK series | |
| | HK series | |
| Test Methods and Remarks | Solder temperature : $230 \pm 5^{\circ}\text{C}$ (JIS Z 3282 H60A or H63A) Solder temperature : $245 \pm 3^{\circ}\text{C}$ (Sn/3.0Ag/0.5Cu) Duration : 4 ± 1 sec. | |

| 12. Resistance to Soldering | | |
|-----------------------------|--|--|
| Specified Value | BK series | Appearance: No significant abnormality |
| | BKP series | Impedance change: Within $\pm 30\%$ |
| | LK series | Appearance: No significant abnormality Inductance change: Within $\pm 15\%$ |
| | HK series | Appearance: No significant abnormality Inductance change: Within $\pm 5\%$ |
| Test Methods and Remarks | Solder temperature : $260 \pm 5^{\circ}\text{C}$ Duration : 10 ± 0.5 sec. Preheating temperature : 150 to 180°C Preheating time : 3 min. Flux : Immersion into methanol solution with colophony for 3 to 5 sec. Recovery : 2 to 3 hrs of recovery under the standard condition after the test. (See Note 1) | |

▶ This catalog contains the typical specification only due to the limitation of space. When you consider the purchase of our products, please check our specification. For details of each product (characteristics graph, reliability information, precautions for use, and so on), see our Web site (<http://www.ty-top.com/>).

| 13. Thermal Shock | | | | | | | | | | | | | | | | |
|--------------------------|--|---|------------------|-------------|---|-------------|------|---|------------------|-----|---|--------------|------|---|------------------|-----|
| Specified Value | BK series | Appearance : No significant abnormality | | | | | | | | | | | | | | |
| | BKP series | Impedance change : Within $\pm 30\%$ | | | | | | | | | | | | | | |
| | LK series | Appearance : No significant abnormality Inductance change : Within $\pm 10\%$ Q change : Within $\pm 30\%$ | | | | | | | | | | | | | | |
| | HK series | Appearance : No significant abnormality Inductance change : Within $\pm 10\%$ Q change : Within $\pm 20\%$ | | | | | | | | | | | | | | |
| Test Methods and Remarks | BK, BKP, HK Series Conditions for 1 cycle | | | | | | | | | | | | | | | |
| | <table border="1"> <thead> <tr> <th>Step</th> <th>temperature (°C)</th> <th>time (min.)</th> </tr> </thead> <tbody> <tr> <td>1</td> <td>-40°C +0/-3</td> <td>30±3</td> </tr> <tr> <td>2</td> <td>Room temperature</td> <td>2~3</td> </tr> <tr> <td>3</td> <td>+125°C +3/-0</td> <td>30±3</td> </tr> <tr> <td>4</td> <td>Room temperature</td> <td>2~3</td> </tr> </tbody> </table> | Step | temperature (°C) | time (min.) | 1 | -40°C +0/-3 | 30±3 | 2 | Room temperature | 2~3 | 3 | +125°C +3/-0 | 30±3 | 4 | Room temperature | 2~3 |
| Step | temperature (°C) | time (min.) | | | | | | | | | | | | | | |
| 1 | -40°C +0/-3 | 30±3 | | | | | | | | | | | | | | |
| 2 | Room temperature | 2~3 | | | | | | | | | | | | | | |
| 3 | +125°C +3/-0 | 30±3 | | | | | | | | | | | | | | |
| 4 | Room temperature | 2~3 | | | | | | | | | | | | | | |
| Test Methods and Remarks | LK Series Conditions for 1 cycle | | | | | | | | | | | | | | | |
| | <table border="1"> <thead> <tr> <th>Step</th> <th>temperature (°C)</th> <th>time (min.)</th> </tr> </thead> <tbody> <tr> <td>1</td> <td>-40°C +0/-3</td> <td>30±3</td> </tr> <tr> <td>2</td> <td>Room temperature</td> <td>2~3</td> </tr> <tr> <td>3</td> <td>+85°C +3/-0</td> <td>30±3</td> </tr> <tr> <td>4</td> <td>Room temperature</td> <td>2~3</td> </tr> </tbody> </table> | Step | temperature (°C) | time (min.) | 1 | -40°C +0/-3 | 30±3 | 2 | Room temperature | 2~3 | 3 | +85°C +3/-0 | 30±3 | 4 | Room temperature | 2~3 |
| Step | temperature (°C) | time (min.) | | | | | | | | | | | | | | |
| 1 | -40°C +0/-3 | 30±3 | | | | | | | | | | | | | | |
| 2 | Room temperature | 2~3 | | | | | | | | | | | | | | |
| 3 | +85°C +3/-0 | 30±3 | | | | | | | | | | | | | | |
| 4 | Room temperature | 2~3 | | | | | | | | | | | | | | |

(Note 1) When there are questions concerning measurement result; measurement shall be made after 48 ± 2 hrs of recovery under the standard condition.

| 14. Damp Heat (Steady state) | | |
|-------------------------------|--|---|
| Specified Value | BK series | Appearance : No significant abnormality |
| | BKP series | Impedance change : Within $\pm 30\%$ |
| | LK series | Appearance : No significant abnormality Inductance change : Within $\pm 10\%$ Q change : Within $\pm 30\%$ |
| | HK series | Appearance : No significant abnormality Inductance change : Within $\pm 10\%$ Q change : Within $\pm 20\%$ |
| Test Methods and Remarks | Temperature : $85 \pm 2^\circ\text{C}$ Humidity : 80 to 85%RH Duration : $1000 + 24 / - 0$ hrs Recovery : 2 to 3 hrs of recovery under the standard condition after the removal from test chamber. (See Note 1) | |

| 15. Loading under Damp Heat | | |
|-----------------------------|---|---|
| Specified Value | BK series | Appearance : No significant abnormality |
| | BKP series | Impedance change : Within $\pm 30\%$ |
| | LK series | Appearance : No significant abnormality Inductance change : Within $\pm 10\%$ Q change : Within $\pm 30\%$ |
| | HK series | Appearance : No significant abnormality Inductance change : Within $\pm 10\%$ Q change : Within $\pm 20\%$ |
| Test Methods and Remarks | Temperature : $85 \pm 2^\circ\text{C}$ Humidity : 80 to 85%RH Applied current : Rated current Duration : $1000 + 24 / - 0$ hrs Recovery : 2 to 3 hrs of recovery under the standard condition after the removal from test chamber. (See Note 1) | |

Note on standard condition: "standard condition" referred to herein is defined as follows:

5 to 35°C of temperature, 45 to 85% relative humidity, and 86 to 106kPa of air pressure.

When there are questions concerning measurement results:

In order to provide correlation data, the test shall be conducted under condition of $20 \pm 2^\circ\text{C}$ of temperature, 60 to 70% relative humidity, and 86 to 106kPa of air pressure.

Unless otherwise specified, all the tests are conducted under the "standard condition."

(Note 1) Measurement shall be made after 48 ± 2 hrs of recovery under the standard condition.

| 16. Loading at High Temperature | | |
|---------------------------------|---|--|
| Specified Value | BK series | Appearance: No significant abnormality |
| | BKP series | Impedance change: Within $\pm 30\%$ |
| | LK series | Appearance: No significant abnormality Inductance change: Within $\pm 10\%$ Q change: Within $\pm 30\%$ |
| | HK series | Appearance: No significant abnormality Inductance change: Within $\pm 10\%$ Q change: Within $\pm 20\%$ |
| Test Methods and Remarks | Temperature : Maximum operating Temperature Applied current : Rated current Duration : 1000+24/-0 hrs Recovery : 2 to 3 hrs of recovery under the standard condition after the removal from test chamber. (See Note 1) | |

Note on standard condition: "standard condition" referred to herein is defined as follows:

5 to 35°C of temperature, 45 to 85% relative humidity, and 86 to 106kPa of air pressure.

When there are questions concerning measurement results:

In order to provide correlation data, the test shall be conducted under condition of $20\pm 2^\circ\text{C}$ of temperature, 60 to 70% relative humidity, and 86 to 106kPa of air pressure. Unless otherwise specified, all the tests are conducted under the "standard condition."

(Note 1) Measurement shall be made after 48 ± 2 hrs of recovery under the standard condition.

Precautions on the use of Multilayer chip inductors

Multilayer chip inductors for high frequency, Multilayer chip bead inductors

PRECAUTIONS

1. Circuit Design

Precautions

- ◆ Verification of operating environment, electrical rating and performance
 1. A malfunction in medical equipment, spacecraft, nuclear reactors, etc. may cause serious harm to human life or have severe social ramifications. As such, any inductors to be used in such equipment may require higher safety and/or reliability considerations and should be clearly differentiated from components used in general purpose applications.
- ◆ Operating Current (Verification of Rated current)
 1. The operating current for inductors must always be lower than their rated values.
 2. Do not apply current in excess of the rated value because the inductance may be reduced due to the magnetic saturation effect.

2. PCB Design

Precautions

- ◆ Pattern configurations (Design of Land-patterns)
 1. When inductors are mounted on a PCB, the size of land patterns and the amount of solder used (size of fillet) can directly affect inductor performance. Therefore, the following items must be carefully considered in the design of solder land patterns:
 - (1) The amount of solder applied can affect the ability of chips to withstand mechanical stresses which may lead to breaking or cracking. Therefore, when designing land-patterns it is necessary to consider the appropriate size and configuration of the solder pads which in turn determines the amount of solder necessary to form the fillets.
 - (2) When more than one part is jointly soldered onto the same land or pad, the pad must be designed so that each component's soldering point is separated by solder-resist.
 - (3) The larger size of land patterns and amount of solder, the smaller Q value after mounting on PCB. It makes higher the Q value to design land patterns smaller than terminal electrode of chips.
- ◆ Pattern configurations (Inductor layout on panelized [breakaway] PC boards)
 1. After inductors have been mounted on the boards, chips can be subjected to mechanical stresses in subsequent manufacturing processes (PCB cutting, board inspection, mounting of additional parts, assembly into the chassis, wave soldering the reflow soldered boards etc.) For this reason, planning pattern configurations and the position of SMD inductors should be carefully performed to minimize stress.

Technical considerations

- ◆ Pattern configurations (Design of Land-patterns)
 1. The following diagrams and tables show some examples of recommended patterns to prevent excessive solder amounts (larger fillets which extend above the component end terminations). Examples of improper pattern designs are also shown.
 - (1) Recommended land dimensions for a typical chip inductor land patterns for PCBs



Recommended land dimensions for wave-soldering (Unit: mm)

| Type | 1608 | 2125 | |
|------|---------|---------|------|
| Size | L | 1.6 | 2.0 |
| | W | 0.8 | 1.25 |
| A | 0.8~1.0 | 1.0~1.4 | |
| B | 0.5~0.8 | 0.8~1.5 | |
| C | 0.6~0.8 | 0.9~1.2 | |

Recommended land dimensions for reflow-soldering (Unit: mm)

| Type | 1005 | 1608 | 2125 | |
|------|-----------|---------|---------|-----|
| Size | L | 1.0 | 2.0 | 1.6 |
| | W | 0.5 | 1.25 | 0.8 |
| A | 0.45~0.55 | 0.8~1.0 | 0.8~1.2 | |
| B | 0.40~0.50 | 0.6~0.8 | 0.8~1.2 | |
| C | 0.45~0.55 | 0.6~0.8 | 0.9~1.6 | |

Excess solder can affect the ability of chips to withstand mechanical stresses. Therefore, please take proper precautions when designing land-patterns.

▶ This catalog contains the typical specification only due to the limitation of space. When you consider the purchase of our products, please check our specification. For details of each product (characteristics graph, reliability information, precautions for use, and so on), see our Web site (<http://www.ty-top.com/>).

(2) Examples of good and bad solder application

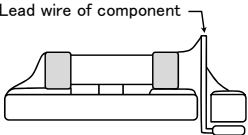
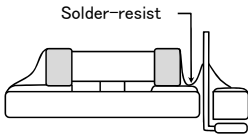
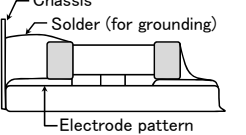
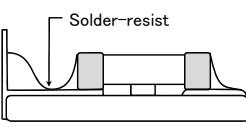
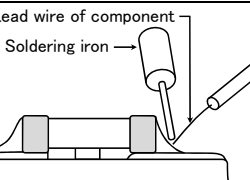
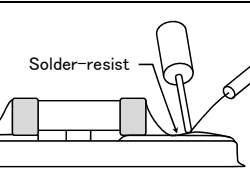
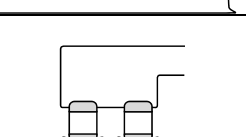
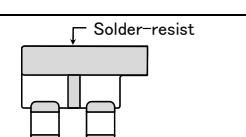
| Item | Not recommended | Recommended |
|---|---|---|
| Mixed mounting of SMD and leaded components |  |  |
| Component placement close to the chassis |  |  |
| Hand-soldering of leaded components near mounted components |  |  |
| Horizontal component placement |  |  |

◆Pattern configurations (Inductor layout on panelized [breakaway] PC boards)

1-1. The following are examples of good and bad inductor layout; SMD inductors should be located to minimize any possible mechanical stresses from board warp or deflection.

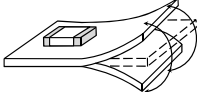
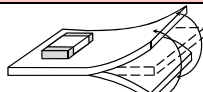
| Item | Not recommended | Recommended |
|-------------------------|--|---|
| Deflection of the board |  |  |

Position the component at a right angle to the direction of the mechanical stresses that are anticipated.

1-2. To layout the inductors for the breakaway PC board, it should be noted that the amount of mechanical stresses given will vary depending on inductor layout.

An example below should be counted for better design.

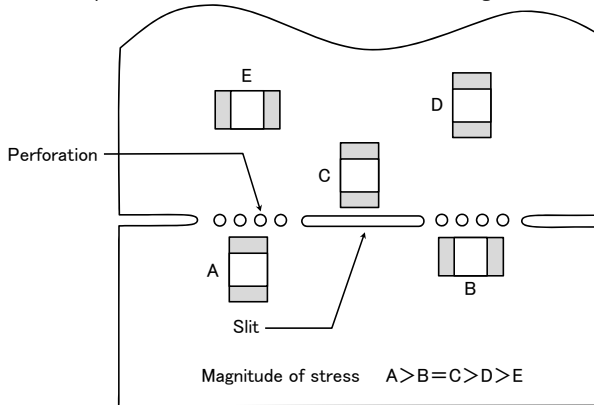

1-3. When breaking PC boards along their perforations, the amount of mechanical stress on the inductors can vary according to the method used. The following methods are listed in order from least stressful to most stressful: push-back, slit, V-grooving, and perforation. Thus, any ideal SMD inductor layout must also consider the PCB splitting procedure.

3. Considerations for automatic placement

Precautions

- ◆ Adjustment of mounting machine
 1. Excessive impact load should not be imposed on the inductors when mounting onto the PC boards.
 2. The maintenance and inspection of the mounter should be conducted periodically.
- ◆ Selection of Adhesives
 1. Mounting inductors with adhesives in preliminary assembly, before the soldering stage, may lead to degraded inductor characteristics unless the following factors are appropriately checked; the size of land patterns, type of adhesive, amount applied, hardening temperature and hardening period. Therefore, it is imperative to consult the manufacturer of the adhesives on proper usage and amounts of adhesive to use.

Technical considerations

- ◆ Adjustment of mounting machine
 1. If the lower limit of the pick-up nozzle is low, too much force may be imposed on the inductors, causing damage. To avoid this, the following points should be considered before lowering the pick-up nozzle:
 - (1) The lower limit of the pick-up nozzle should be adjusted to the surface level of the PC board after correcting for deflection of the board.
 - (2) The pick-up pressure should be adjusted between 1 and 3N static loads.
 - (3) To reduce the amount of deflection of the board caused by impact of the pick-up nozzle, supporting pins or back-up pins should be used under the PC board. The following diagrams show some typical examples of good pick-up nozzle placement:

| Item | Improper method | Proper method |
|-----------------------|---|---|
| Single-sided mounting |  |  |
| Double-sided mounting |  |  |

2. As the alignment pin wears out, adjustment of the nozzle height can cause chipping or cracking of the inductors because of mechanical impact on the inductors. To avoid this, the monitoring of the width between the alignment pin in the stopped position, and maintenance, inspection and replacement of the pin should be conducted periodically.

- ◆ Selection of Adhesives
 1. Some adhesives may cause reduced insulation resistance. The difference between the shrinkage percentage of the adhesive and that of the inductors may result in stresses on the inductors and lead to cracking. Moreover, too little or too much adhesive applied to the board may adversely affect component placement, so the following precautions should be noted in the application of adhesives.

- (1) Required adhesive characteristics
 - a. The adhesive should be strong enough to hold parts on the board during the mounting & solder process.
 - b. The adhesive should have sufficient strength at high temperatures.
 - c. The adhesive should have good coating and thickness consistency.
 - d. The adhesive should be used during its prescribed shelf life.
 - e. The adhesive should harden rapidly.
 - f. The adhesive must not be contaminated.
 - g. The adhesive should have excellent insulation characteristics.
 - h. The adhesive should not be toxic and have no emission of toxic gasses.
- (2) When using adhesives to mount inductors on a PCB, inappropriate amounts of adhesive on the board may adversely affect component placement. Too little adhesive may cause the inductors to fall off the board during the solder process. Too much adhesive may cause defective soldering due excessive flow of adhesive on to the land or solder pad.

[Recommended conditions]

| Figure | 0805 case sizes as examples |
|--------|-----------------------------|
| a | 0.3mm min |
| b | 100~120 μm |
| c | Area with no adhesive |

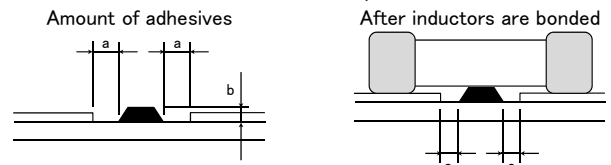

4. Soldering

Precautions

- ◆ Selection of Flux
 1. Since flux may have a significant effect on the performance of inductors, it is necessary to verify the following conditions prior to use;
 - (1) Flux used should be with less than or equal to 0.1 wt% (Chlorine conversion method) of halogenated content. Flux having a strong acidity content should not be applied.
 - (2) When soldering inductors on the board, the amount of flux applied should be controlled at the optimum level.
 - (3) When using water-soluble flux, special care should be taken to properly clean the boards.
- ◆ Soldering
 1. Temperature, time, amount of solder, etc. are specified in accordance with the following recommended conditions, and please contact us about peak temperature when you use lead-free paste.

▶ This catalog contains the typical specification only due to the limitation of space. When you consider the purchase of our products, please check our specification. For details of each product (characteristics graph, reliability information, precautions for use, and so on), see our Web site (<http://www.ty-top.com/>).

◆ Selection of Flux

- 1-1. When too much halogenated substance (Chlorine, etc.) content is used to activate the flux, or highly acidic flux is used, an excessive amount of residue after soldering may lead to corrosion of the terminal electrodes or degradation of insulation resistance on the surface of the Inductor.
- 1-2. Flux is used to increase solderability in flow soldering, but if too much is applied, a large amount of flux gas may be emitted and may detrimentally affect solderability. To minimize the amount of flux applied, it is recommended to use a flux-bubbling system.
- 1-3. Since the residue of water-soluble flux is easily dissolved by water content in the air, the residue on the surface of Inductor in high humidity conditions may cause a degradation of insulation resistance and therefore affect the reliability of the components. The cleaning methods and the capability of the machines used should also be considered carefully when selecting water-soluble flux.

◆ Soldering

1-1. Preheating when soldering

Heating: Chip inductor components should be preheated to within 100 to 130°C of the soldering. Cooling: The temperature difference between the components and cleaning process should not be greater than 100°C.

Chip inductors are susceptible to thermal shock when exposed to rapid or concentrated heating or rapid cooling. Therefore, the soldering process must be conducted with a great care so as to prevent malfunction of the components due to excessive thermal shock.

[Reflow soldering]

【Recommended conditions for eutectic soldering】



【Recommended condition for Pb-free soldering】



- ※Ceramic chip components should be preheated to within 100 to 130°C of the soldering.
- ※Assured to be reflow soldering for 2 times.

Caution

1. The ideal condition is to have solder mass (fillet) controlled to 1/2 to 1/3 of the thickness of the inductor, as shown below:



2. Because excessive dwell times can detrimentally affect solderability, soldering duration should be kept as close to recommended times as possible.

[Wave soldering]

【Recommended conditions for eutectic soldering】



【Recommended condition for Pb-free soldering】



- ※Ceramic chip components should be preheated to within 100 to 130°C of the soldering.
- ※Assured to be wave soldering for 1 time.
- ※Except for reflow soldering type.

Caution

1. Make sure the inductors are preheated sufficiently.
2. The temperature difference between the inductor and melted solder should not be greater than 100 to 130°C.
3. Cooling after soldering should be as gradual as possible.
4. Wave soldering must not be applied to the inductors designated as for reflow soldering only.

[Hand soldering]

【Recommended conditions for eutectic soldering】



【Recommended condition for Pb-free soldering】



- (※) ΔT: 190°C
- ※It is recommended to use 20W soldering iron and the tip is 1 φ or less.
- ※The soldering iron should not directly touch the components.
- ※Assured to be soldering iron for 1 time.
- Note: The above profiles are the maximum allowable soldering condition, therefore these profiles are not always recommended.

Technical considerations

| | |
|--|--|
| | <p>Caution</p> <ol style="list-style-type: none"> 1. Use a 20W soldering iron with a maximum tip diameter of 1.0 mm. 2. The soldering iron should not directly touch the inductor. |
|--|--|

5. Cleaning

| | | | | | | | |
|---------------------------|--|-------------------|-------------|----------------------|-------------|---------------------------|----------------|
| Precautions | <p>◆Cleaning conditions</p> <ol style="list-style-type: none"> 1. When cleaning the PC board after the Inductors are all mounted, select the appropriate cleaning solution according to the type of flux used and purpose of the cleaning (e.g. to remove soldering flux or other materials from the production process.) 2. Cleaning conditions should be determined after verifying, through a test run, that the cleaning process does not affect the inductor's characteristics. | | | | | | |
| Technical considerations | <p>◆Cleaning conditions</p> <ol style="list-style-type: none"> 1. The use of inappropriate solutions can cause foreign substances such as flux residue to adhere to the inductor, resulting in a degradation of the inductor's electrical properties (especially insulation resistance). 2. Inappropriate cleaning conditions (insufficient or excessive cleaning) may detrimentally affect the performance of the inductors. <ol style="list-style-type: none"> (1) Excessive cleaning <ol style="list-style-type: none"> a. In the case of ultrasonic cleaning, too much power output can cause excessive vibration of the PC board which may lead to the cracking of the inductor or the soldered portion, or decrease the terminal electrodes' strength. Thus the following conditions should be carefully checked; <table style="margin-left: 20px; border: none;"> <tr> <td style="padding-right: 20px;">Ultrasonic output</td> <td>Below 20W/l</td> </tr> <tr> <td>Ultrasonic frequency</td> <td>Below 40kHz</td> </tr> <tr> <td>Ultrasonic washing period</td> <td>5 min. or less</td> </tr> </table> | Ultrasonic output | Below 20W/l | Ultrasonic frequency | Below 40kHz | Ultrasonic washing period | 5 min. or less |
| Ultrasonic output | Below 20W/l | | | | | | |
| Ultrasonic frequency | Below 40kHz | | | | | | |
| Ultrasonic washing period | 5 min. or less | | | | | | |

6. Post cleaning processes

| | |
|-------------|---|
| Precautions | <p>◆Application of resin coatings, moldings, etc. to the PCB and components.</p> <ol style="list-style-type: none"> 1. With some type of resins a decomposition gas or chemical reaction vapor may remain inside the resin during the hardening period or while left under normal storage conditions resulting in the deterioration of the inductor's performance. 2. When a resin's hardening temperature is higher than the inductor's operating temperature, the stresses generated by the excess heat may lead to inductor damage or destruction. 3. Stress caused by a resin's temperature generated expansion and contraction may damage inductors. The use of such resins, molding materials etc. is not recommended. When inductors are coated/molded with resin, please check effects on the inductors by analyzing them in actual applications prior to use. |
|-------------|---|

7. Handling

| | |
|-------------|---|
| Precautions | <p>◆Breakaway PC boards (splitting along perforations)</p> <ol style="list-style-type: none"> 1. When splitting the PC board after mounting inductors and other components, care is required so as not to give any stresses of deflection or twisting to the board. 2. Board separation should not be done manually, but by using the appropriate devices. <p>◆General handling precautions</p> <ol style="list-style-type: none"> 1. Always wear static control bands to protect against ESD. 2. Keep the inductors away from all magnets and magnetic objects. 3. Use non-magnetic tweezers when handling inductors. 4. Any devices used with the inductors (soldering irons, measuring instruments) should be properly grounded. 5. Keep bare hands and metal products (i.e., metal desk) away from chip electrodes or conductive areas that lead to chip electrodes. 6. Keep inductors away from items that generate magnetic fields such as speakers or coils. <p>◆Mechanical considerations</p> <ol style="list-style-type: none"> 1. Be careful not to subject the inductors to excessive mechanical shocks. <ol style="list-style-type: none"> (1) If inductors are dropped on the floor or a hard surface they should not be used. (2) When handling the mounted boards, be careful that the mounted components do not come in contact with or bump against other boards or components. |
|-------------|---|

8. Storage conditions

| | | | |
|---------------------------------|--|---------------------------------|------------------------|
| Precautions | <p>◆Storage</p> <ol style="list-style-type: none"> 1. To maintain the solderability of terminal electrodes and to keep the packaging material in good condition, care must be taken to control temperature and humidity in the storage area. Humidity should especially be kept as low as possible. <ul style="list-style-type: none"> •Recommended conditions <table style="margin-left: 20px; border: none;"> <tr> <td style="padding-right: 20px;">Ambient temperature: Below 30°C</td> <td>Humidity: Below 70% RH</td> </tr> </table> The ambient temperature must be kept below 40°C. Even under ideal storage conditions, solderability of inductor is deteriorated as time passes, so inductors should be used within 6 months from the time of delivery. <ul style="list-style-type: none"> •Inductor should be kept where no chlorine or sulfur exists in the air. | Ambient temperature: Below 30°C | Humidity: Below 70% RH |
| Ambient temperature: Below 30°C | Humidity: Below 70% RH | | |
| Technical considerations | <p>◆Storage</p> <ol style="list-style-type: none"> 1. If the parts are stocked in a high temperature and humidity environment, problems such as reduced solderability caused by oxidation of terminal electrodes and deterioration of taping/packaging materials may take place. For this reason, components should be used within 6 months from the time of delivery. If exceeding the above period, please check solderability before using the inductors. | | |

▶ This catalog contains the typical specification only due to the limitation of space. When you consider the purchase of our products, please check our specification. For details of each product (characteristics graph, reliability information, precautions for use, and so on), see our Web site (<http://www.ty-top.com/>).



Компания «ЭлектроПласт» предлагает заключение долгосрочных отношений при поставках импортных электронных компонентов на взаимовыгодных условиях!

Наши преимущества:

- Оперативные поставки широкого спектра электронных компонентов отечественного и импортного производства напрямую от производителей и с крупнейших мировых складов;
- Поставка более 17-ти миллионов наименований электронных компонентов;
- Поставка сложных, дефицитных, либо снятых с производства позиций;
- Оперативные сроки поставки под заказ (от 5 рабочих дней);
- Экспресс доставка в любую точку России;
- Техническая поддержка проекта, помощь в подборе аналогов, поставка прототипов;
- Система менеджмента качества сертифицирована по Международному стандарту ISO 9001;
- Лицензия ФСБ на осуществление работ с использованием сведений, составляющих государственную тайну;
- Поставка специализированных компонентов (Xilinx, Altera, Analog Devices, Intersil, Interpoint, Microsemi, Aeroflex, Peregrine, Syfer, Eurofarad, Texas Instrument, Miteq, Cobham, E2V, MA-COM, Hittite, Mini-Circuits, General Dynamics и др.);

Помимо этого, одним из направлений компании «ЭлектроПласт» является направление «Источники питания». Мы предлагаем Вам помощь Конструкторского отдела:

- Подбор оптимального решения, техническое обоснование при выборе компонента;
- Подбор аналогов;
- Консультации по применению компонента;
- Поставка образцов и прототипов;
- Техническая поддержка проекта;
- Защита от снятия компонента с производства.



Как с нами связаться

Телефон: 8 (812) 309 58 32 (многоканальный)

Факс: 8 (812) 320-02-42

Электронная почта: org@eplast1.ru

Адрес: 198099, г. Санкт-Петербург, ул. Калинина, дом 2, корпус 4, литера А.