

# NZ9F2V4T5G, SZNZ9F2V4T5G SERIES

## Zener Voltage Regulators

### 200 mW SOD-923 Surface Mount

This series of Zener diodes is packaged in a SOD-923 surface mount package. They are designed to provide voltage regulation protection and are especially attractive in situations where space is at a premium. They are well suited for applications such as cellular phones, hand held portables, and high density PC boards.

#### Specification Features:

- Standard Zener Breakdown Voltage Range – 2.4 V to 24 V
- Steady State Power Rating of 200 mW
- Small Body Outline Dimensions:  
0.039" x 0.024" (1.00 mm x 0.60 mm)
- Low Body Height: 0.016" (0.40 mm)
- ESD Rating of Class 3 (>16 kV) per Human Body Model
- SZ Prefix for Automotive and Other Applications Requiring Unique Site and Control Change Requirements; AEC-Q101 Qualified and PPAP Capable
- These are Pb-Free Devices

#### Mechanical Characteristics:

**CASE:** Void-free, transfer-molded, thermosetting plastic  
Epoxy Meets UL 94 V-0

**LEAD FINISH:** 100% Matte Sn (Tin)

**MOUNTING POSITION:** Any

**QUALIFIED MAX REFLOW TEMPERATURE:** 260°C  
Device Meets MSL 1 Requirements

#### MAXIMUM RATINGS

Rating	Symbol	Max	Unit
Total Device Dissipation FR-5 Board, (Note 1) @ $T_A = 25^\circ\text{C}$ Derate above $25^\circ\text{C}$	$P_D$	250 2.0	mW mW/°C
Thermal Resistance from Junction-to-Ambient	$R_{\theta JA}$	500	°C/W
Junction and Storage Temperature Range	$T_J, T_{stg}$	-65 to +150	°C

Stresses exceeding Maximum Ratings may damage the device. Maximum Ratings are stress ratings only. Functional operation above the Recommended Operating Conditions is not implied. Extended exposure to stresses above the Recommended Operating Conditions may affect device reliability.

1. FR-4 Minimum Pad.



**ON Semiconductor®**

<http://onsemi.com>

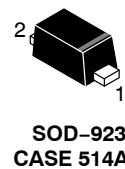
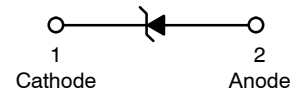

#### MARKING DIAGRAM

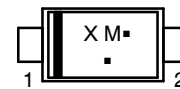

- X = Specific Device Code  
M = Month Code  
▪ = Pb-Free Package  
(Note: Microdot may be in either location)

#### ORDERING INFORMATION

Device	Package	Shipping†
NZ9FxxxxT5G, SZNZ9FxxxxT5G	SOD-923 (Pb-Free)	8000/Tape & Reel

†For information on tape and reel specifications, including part orientation and tape sizes, please refer to our Tape and Reel Packaging Specifications Brochure, BRD8011/D.

#### DEVICE MARKING INFORMATION

See specific marking information in the device marking column of the Electrical Characteristics tables starting on page 3 of this data sheet.

# NZ9F2V4T5G, SZNZ9F2V4T5G SERIES

## ELECTRICAL CHARACTERISTICS

( $T_A = 25^\circ\text{C}$  unless otherwise noted,  
 $V_F = 0.9\text{ V Max. @ } I_F = 10\text{ mA}$  for all types)

Symbol	Parameter
$V_Z$	Reverse Zener Voltage @ $I_{ZT}$
$I_{ZT}$	Reverse Current
$Z_{ZT}$	Maximum Zener Impedance @ $I_{ZT}$
$I_{ZK}$	Reverse Current
$Z_{ZK}$	Maximum Zener Impedance @ $I_{ZK}$
$I_R$	Reverse Leakage Current @ $V_R$
$V_R$	Reverse Voltage
$I_F$	Forward Current
$V_F$	Forward Voltage @ $I_F$
$\Theta_{VZ}$	Maximum Temperature Coefficient of $V_Z$
C	Max. Capacitance @ $V_R = 0$ and $f = 1\text{ MHz}$

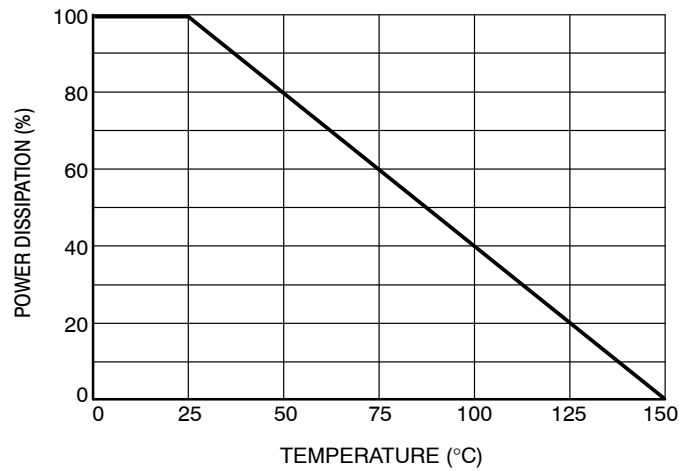
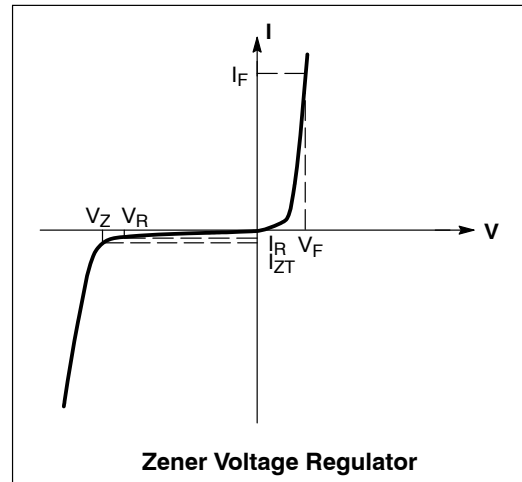

**Figure 1. Steady State Power Derating**

## NZ9F2V4T5G, SZNZ9F2V4T5G SERIES

**ELECTRICAL CHARACTERISTICS** ( $T_A = 25^\circ\text{C}$  unless otherwise noted,  $V_F = 0.9\text{ V Max.}$  @  $I_F = 10\text{ mA}$  for all types)

Device***	Device Marking	Zener Voltage (Note 1)			Zener Impedance			Leakage Current		$\theta_{V_Z}$ (mV/k) @ $I_{ZT}$		C @ $V_R = 0$ f = 1 MHz
		$V_Z$ (Volts)		@ $I_{ZT}$	$Z_{ZT}$ @ $I_{ZT}$	$Z_{ZK}$ @ $I_{ZK}$		$I_R$ @ $V_R$				
		Min	Max	mA	$\Omega$	$\Omega$	mA	$\mu\text{A}$	Volts	Min	Max	pF
SZ, NZ9F2V4T5G	J	2.28	2.52	5	100	1000	1	50	1	-3.5	0	210
SZ, NZ9F2V7T5G	E**	2.57	2.84	5	100	1000	1	20	1	-3.5	0	210
SZ, NZ9F3V0T5G	T**	2.85	3.15	5	100	1000	1	10	1	-3.5	0	210
SZ, NZ9F3V3T5G	Q	3.14	3.47	5	100	1000	1	10	1	-3.5	0	210
SZ, NZ9F3V6T5G	3**	3.42	3.78	5	100	1000	1	10	1	-3.5	0	210
SZ, NZ9F3V9T5G	V**	3.71	4.10	5	100	1000	1	5	1	-3.5	-2.5	210
SZ, NZ9F4V3T5G	Y**	4.09	4.52	5	100	1000	1	5	1	-3.5	0	210
SZ, NZ9F4V7T5G	3	4.47	4.94	5	100	800	0.5	2	1	-3.5	0.2	150
SZ, NZ9F5V1T5G	4	4.85	5.36	5	80	500	0.5	2	1.5	-2.7	1.2	130
SZ, NZ9F5V6T5G	5	5.32	5.88	5	60	200	0.5	1	2.5	-2.0	2.5	115
SZ, NZ9F6V2T5G	6	5.89	6.51	5	60	100	0.5	1	3	0.4	3.7	110
SZ, NZ9F6V8T5G	A*	6.46	7.14	5	40	60	0.5	0.5	3.5	1.2	4.5	105
SZ, NZ9F7V5T5G	D*	7.13	7.88	5	30	60	0.5	0.5	4	2.5	5.3	100
SZ, NZ9F8V2T5G	E*	7.79	8.61	5	30	60	0.5	0.5	5	3.2	6.2	90
SZ, NZ9F9V1T5G	F*	8.65	9.56	5	30	60	0.5	0.5	6	3.8	7	80
SZ, NZ9F10VT5G	J*	9.50	10.50	5	30	60	0.5	0.1	7	4.5	8	80
SZ, NZ9F11VT5G	K*	10.45	11.55	5	30	60	0.5	0.1	8	5.4	9	80
SZ, NZ9F12VT5G	L*	11.40	12.60	5	30	80	0.5	0.1	9	6	10	80
SZ, NZ9F13VT5G	P*	12.35	13.65	5	37	80	0.5	0.1	10	7	11	75
SZ, NZ9F15VT5G	Q*	14.25	15.75	5	42	80	0.5	0.1	11	9.2	13	70
SZ, NZ9F16VT5G	R*	15.20	16.80	5	50	80	0.5	0.1	12	10.4	14	65
SZ, NZ9F18VT5G	T*	17.10	18.90	5	50	80	0.5	0.1	14	12.4	16	60
SZ, NZ9F20VT5G	V*	19.00	21.00	5	55	100	0.5	0.1	15.4	14.4	18	55
SZ, NZ9F22VT5G	Y*	20.90	23.10	5	55	100	0.5	0.1	16.8	15.4	20	55
SZ, NZ9F24VT5G	F	22.80	25.20	5	70	120	0.5	0.1	18.9	16.8	22	50

\*Rotated 90°.

\*\*Rotated 270°.

\*\*\*SZ Prefix for Automotive and Other Applications Requiring Unique Site and Control Change Requirements; AEC-Q101 Qualified and PPAP Capable.

1. Zener voltage is measured with a pulse test current  $I_Z$  at an ambient temperature of 25°C.

# NZ9F2V4T5G, SZNZ9F2V4T5G SERIES

## PACKAGE DIMENSIONS

**SOD-923**  
CASE 514AB  
ISSUE C

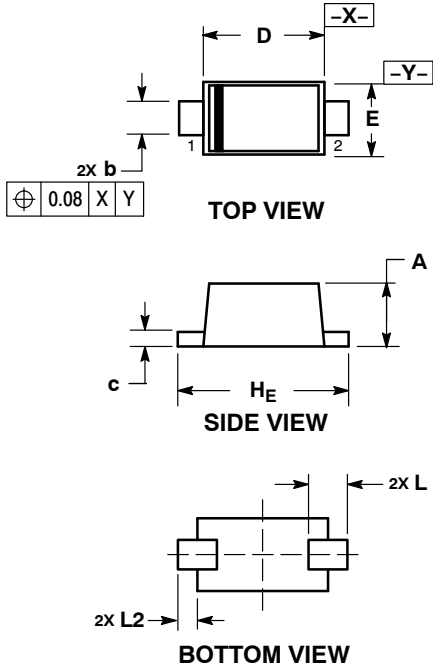

- NOTES:
1. DIMENSIONING AND TOLERANCING PER ASME Y14.5M, 1994.
  2. CONTROLLING DIMENSION: MILLIMETERS.
  3. MAXIMUM LEAD THICKNESS INCLUDES LEAD FINISH. MINIMUM LEAD THICKNESS IS THE MINIMUM THICKNESS OF BASE MATERIAL.
  4. DIMENSIONS D AND E DO NOT INCLUDE MOLD FLASH, PROTRUSIONS, OR GATE BURRS.

DIM	MILLIMETERS			INCHES		
	MIN	NOM	MAX	MIN	NOM	MAX
A	0.34	0.37	0.40	0.013	0.015	0.016
b	0.15	0.20	0.25	0.006	0.008	0.010
c	0.07	0.12	0.17	0.003	0.005	0.007
D	0.75	0.80	0.85	0.030	0.031	0.033
E	0.55	0.60	0.65	0.022	0.024	0.026
H <sub>E</sub>	0.95	1.00	1.05	0.037	0.039	0.041
L	0.19 REF			0.007 REF		
L <sub>2</sub>	0.05	0.10	0.15	0.002	0.004	0.006

### SOLDERING FOOTPRINT\*

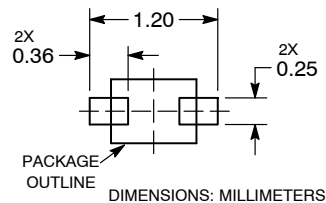

See Application Note AND8455/D for more mounting details

\*For additional information on our Pb-Free strategy and soldering details, please download the ON Semiconductor Soldering and Mounting Techniques Reference Manual, SOLDERRM/D.

ON Semiconductor and are registered trademarks of Semiconductor Components Industries, LLC (SCILLC). SCILLC owns the rights to a number of patents, trademarks, copyrights, trade secrets, and other intellectual property. A listing of SCILLC's product/patent coverage may be accessed at [www.onsemi.com/site/pdf/Patent-Marking.pdf](http://www.onsemi.com/site/pdf/Patent-Marking.pdf). SCILLC reserves the right to make changes without further notice to any products herein. SCILLC makes no warranty, representation or guarantee regarding the suitability of its products for any particular purpose, nor does SCILLC assume any liability arising out of the application or use of any product or circuit, and specifically disclaims any and all liability, including without limitation special, consequential or incidental damages. "Typical" parameters which may be provided in SCILLC data sheets and/or specifications can and do vary in different applications and actual performance may vary over time. All operating parameters, including "Typicals" must be validated for each customer application by customer's technical experts. SCILLC does not convey any license under its patent rights nor the rights of others. SCILLC products are not designed, intended, or authorized for use as components in systems intended for surgical implant into the body, or other applications intended to support or sustain life, or for any other application in which the failure of the SCILLC product could create a situation where personal injury or death may occur. Should Buyer purchase or use SCILLC products for any such unintended or unauthorized application, Buyer shall indemnify and hold SCILLC and its officers, employees, subsidiaries, affiliates, and distributors harmless against all claims, costs, damages, and expenses, and reasonable attorney fees arising out of, directly or indirectly, any claim of personal injury or death associated with such unintended or unauthorized use, even if such claim alleges that SCILLC was negligent regarding the design or manufacture of the part. SCILLC is an Equal Opportunity/Affirmative Action Employer. This literature is subject to all applicable copyright laws and is not for resale in any manner.

### PUBLICATION ORDERING INFORMATION

**LITERATURE FULFILLMENT:**  
Literature Distribution Center for ON Semiconductor  
P.O. Box 5163, Denver, Colorado 80217 USA  
**Phone:** 303-675-2175 or 800-344-3860 Toll Free USA/Canada  
**Fax:** 303-675-2176 or 800-344-3867 Toll Free USA/Canada  
**Email:** [orderlit@onsemi.com](mailto:orderlit@onsemi.com)

**N. American Technical Support:** 800-282-9855 Toll Free  
USA/Canada  
**Europe, Middle East and Africa Technical Support:**  
Phone: 421 33 790 2910  
**Japan Customer Focus Center**  
Phone: 81-3-5817-1050

**ON Semiconductor Website:** [www.onsemi.com](http://www.onsemi.com)  
**Order Literature:** <http://www.onsemi.com/orderlit>  
For additional information, please contact your local Sales Representative



Компания «ЭлектроПласт» предлагает заключение долгосрочных отношений при поставках импортных электронных компонентов на взаимовыгодных условиях!

Наши преимущества:

- Оперативные поставки широкого спектра электронных компонентов отечественного и импортного производства напрямую от производителей и с крупнейших мировых складов;
- Поставка более 17-ти миллионов наименований электронных компонентов;
- Поставка сложных, дефицитных, либо снятых с производства позиций;
- Оперативные сроки поставки под заказ (от 5 рабочих дней);
- Экспресс доставка в любую точку России;
- Техническая поддержка проекта, помощь в подборе аналогов, поставка прототипов;
- Система менеджмента качества сертифицирована по Международному стандарту ISO 9001;
- Лицензия ФСБ на осуществление работ с использованием сведений, составляющих государственную тайну;
- Поставка специализированных компонентов (Xilinx, Altera, Analog Devices, Intersil, Interpoint, Microsemi, Aeroflex, Peregrine, Syfer, Eurofarad, Texas Instrument, Miteq, Cobham, E2V, MA-COM, Hittite, Mini-Circuits, General Dynamics и др.);

Помимо этого, одним из направлений компании «ЭлектроПласт» является направление «Источники питания». Мы предлагаем Вам помощь Конструкторского отдела:

- Подбор оптимального решения, техническое обоснование при выборе компонента;
- Подбор аналогов;
- Консультации по применению компонента;
- Поставка образцов и прототипов;
- Техническая поддержка проекта;
- Защита от снятия компонента с производства.



#### Как с нами связаться

**Телефон:** 8 (812) 309 58 32 (многоканальный)

**Факс:** 8 (812) 320-02-42

**Электронная почта:** [org@eplast1.ru](mailto:org@eplast1.ru)

**Адрес:** 198099, г. Санкт-Петербург, ул. Калинина, дом 2, корпус 4, литера А.