



$V_{(BR)DSX} / V_{(BR)DGX}$	$R_{DS(on)}$ (max)	$I_{DSS}$ (min)	Package
350V <sub>P</sub>	35Ω	140mA	SOT-89

### Features

- Low  $R_{DS(on)}$  at Cold Temperatures
- $R_{DS(on)}$  35Ω max. at 25°C
- High Input Impedance
- High Breakdown Voltage: 350V<sub>P</sub>
- Low  $V_{GS(off)}$  Voltage: -1.6 to -3.9V
- Small Package Size: SOT-89

### Applications

- Ignition Modules
- Normally-On Switches
- Solid State Relays
- Converters
- Telecommunications
- Power Supply

### Description

The CPC3730 is an N-channel, depletion mode, field effect transistor (FET) that utilizes IXYS Integrated Circuits Division's proprietary third-generation vertical DMOS process. The third-generation process realizes world class, high voltage MOSFET performance in an economical silicon gate process. Our vertical DMOS process yields a robust device, with high input impedance, for use in high power applications. The CPC3730 is a highly reliable FET device that has been used extensively in our solid state relays for industrial and telecommunications applications.

This device excels in power applications requiring low drain-source resistance, particularly in cold environments such as automotive ignition modules. The CPC3730 offers a low, 35Ω maximum, on-state resistance at 25°C.

The CPC3730 has a minimum breakdown voltage of 350V<sub>P</sub>, and is available in an SOT-89 package. As with all MOS devices, the FET structure prevents thermal runaway and thermal-induced secondary breakdown.

### Ordering Information

Part #	Description
CPC3730CTR	N-Channel Depletion Mode FET, SOT-89 Pkg. Tape and Reel (1000/Reel)

### Package Pinout

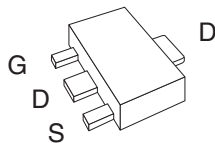

(SOT-89)

### Circuit Symbol

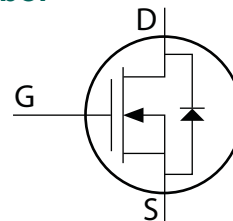

### Absolute Maximum Ratings @ 25°C

Parameter	Ratings	Units
Drain-to-Source Voltage	350	V <sub>P</sub>
Gate-to-Source Voltage	±15	V <sub>P</sub>
Pulsed Drain Current	600	mA
Power Dissipation <sup>1</sup>	1.4	W
Junction Temperature	+125	°C
Operational Temperature	-55 to +125	°C
Storage Temperature	-55 to +125	°C

<sup>1</sup> Mounted on FR4 board 1"x1"x0.062"

Absolute Maximum Ratings are stress ratings. Stresses in excess of these ratings can cause permanent damage to the device. Functional operation of the device at conditions beyond those indicated in the operational sections of this data sheet is not implied.

Typical values are characteristic of the device at +25°C, and are the result of engineering evaluations. They are provided for information purposes only, and are not part of the manufacturing testing requirements.

### Electrical Characteristics @ 25°C (Unless Otherwise Noted)

Parameter	Symbol	Conditions	Min	Typ	Max	Units
Drain-to-Source Breakdown Voltage	V <sub>(BR)DSX</sub>	V <sub>GS</sub> = -5V, I <sub>D</sub> =100µA	350	-	-	V <sub>P</sub>
Gate-to-Source Off Voltage	V <sub>GS(off)</sub>	I <sub>DS</sub> = 5V, I <sub>D</sub> =1mA	-1.6	-	-3.9	V
Change in V <sub>GS(off)</sub> with Temperatures	dV <sub>GS(off)</sub> /dT	V <sub>DS</sub> = 5V, I <sub>D</sub> =1µA	-	-	4.5	mV/°C
Gate Body Leakage Current	I <sub>GSS</sub>	V <sub>GS</sub> =±15V, V <sub>DS</sub> =0V	-	-	100	nA
Drain-to-Source Leakage Current	I <sub>D(off)</sub>	V <sub>GS</sub> = -5V, V <sub>DS</sub> =350V	-	-	1	µA
		V <sub>GS</sub> = -5V, V <sub>DS</sub> =280V, T <sub>A</sub> =125°C	-	-	1	mA
Saturated Drain-to-Source Current	I <sub>DSS</sub>	V <sub>GS</sub> = 0V, V <sub>DS</sub> =15V	140	-	-	mA
Static Drain-to-Source On-State Resistance	R <sub>DS(on)</sub>	V <sub>GS</sub> = 0V, I <sub>D</sub> =140mA	-	-	35	Ω
Change in R <sub>DS(on)</sub> with Temperatures	dR <sub>DS(on)</sub> /dT	V <sub>GS</sub> = 0V, I <sub>D</sub> =140mA	-	-	1.1	%/°C
Forward Transconductance	G <sub>FS</sub>	I <sub>D</sub> = 100mA, V <sub>DS</sub> = 10V	150	-	-	mS
Input Capacitance	C <sub>ISS</sub>	V <sub>GS</sub> = -5V V <sub>DS</sub> = 25V f= 1MHz	-	100	200	pF
Common Source Output Capacitance	C <sub>OSS</sub>		20	100		
Reverse Transfer Capacitance	C <sub>RSS</sub>		5	80		
Turn-On Delay Time	t <sub>d(on)</sub>	V <sub>DD</sub> = 25V I <sub>D</sub> = 150mA V <sub>GS</sub> = 0V to -10V R <sub>gen</sub> = 50Ω	-	20	-	ns
Rise Time	t <sub>r</sub>		10	-		
Turn-Off Delay Time	t <sub>d(off)</sub>		20	-		
Fall time	t <sub>f</sub>		50	-		
Source-Drain Diode Voltage Drop	V <sub>SD</sub>	V <sub>GS</sub> = -5V, I <sub>SD</sub> = 150mA	-	0.6	1.8	V
Thermal Resistance (Junction to Ambient)	R <sub>θJA</sub>	-	-	90	-	°C/W

### Thermal Characteristics

Thermal Impedance	Symbol	Rating	Units
Junction to ambient	Θ <sub>JA</sub>	90	°C/W
Junction to case	Θ <sub>JC</sub>	50	°C/W

### Switching Waveform & Test Circuit

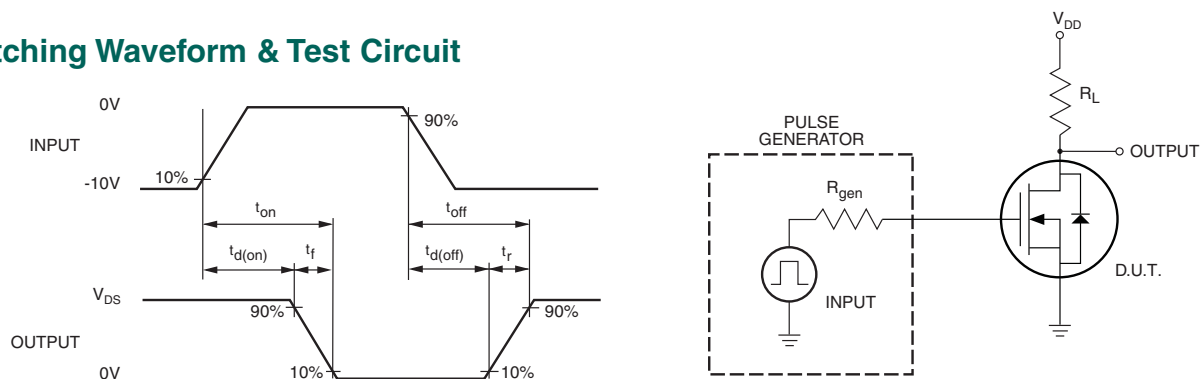

**PERFORMANCE DATA \***

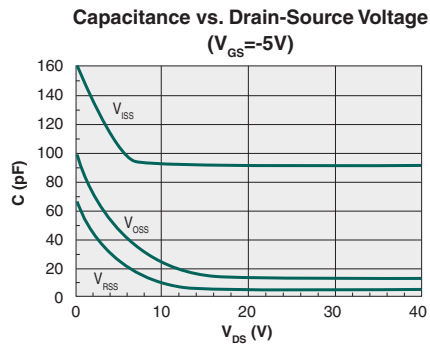
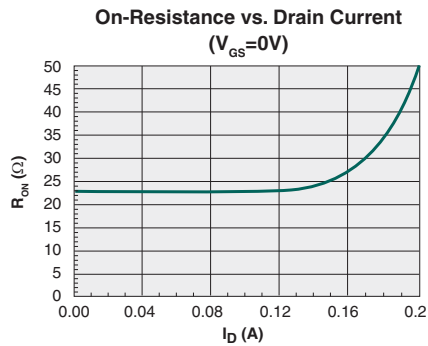
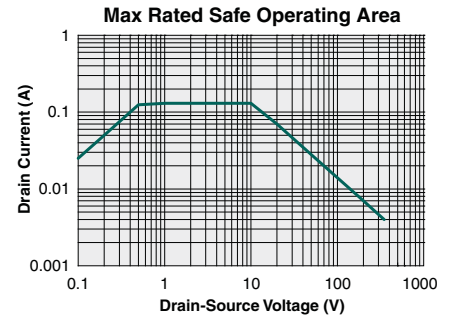
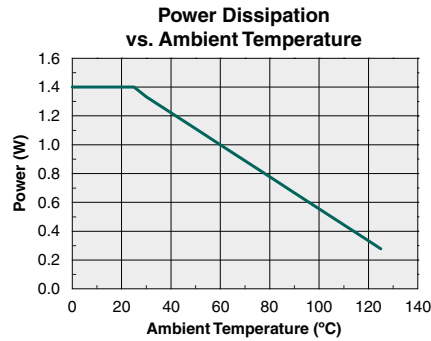
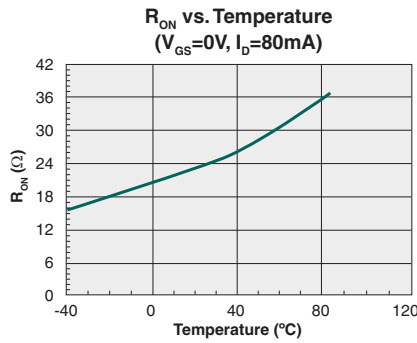
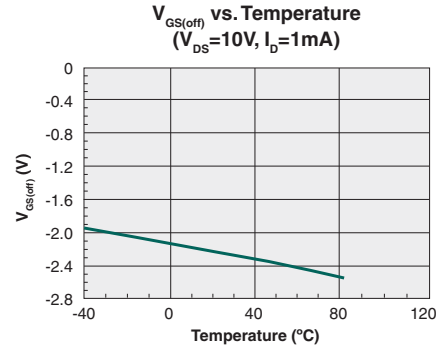
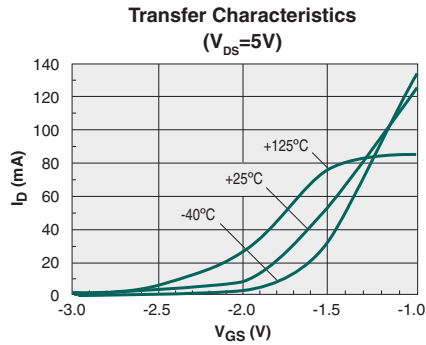
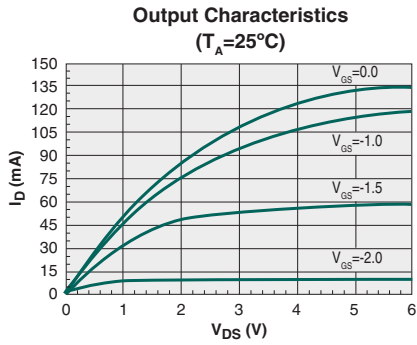

\*The Performance data shown in the graphs above is typical of device performance. For guaranteed parameters not indicated in the written specifications, please contact our application department.

## Manufacturing Information

### Moisture Sensitivity



All plastic encapsulated semiconductor packages are susceptible to moisture ingress. IXYS Integrated Circuits Division classifies its plastic encapsulated devices for moisture sensitivity according to the latest version of the joint industry standard, **IPC/JEDEC J-STD-020**, in force at the time of product evaluation. We test all of our products to the maximum conditions set forth in the standard, and guarantee proper operation of our devices when handled according to the limitations and information in that standard as well as to any limitations set forth in the information or standards referenced below.

Failure to adhere to the warnings or limitations as established by the listed specifications could result in reduced product performance, reduction of operable life, and/or reduction of overall reliability.

This product carries a Moisture Sensitivity Level (MSL) classification as shown below, and should be handled according to the requirements of the latest version of the joint industry standard **IPC/JEDEC J-STD-033**.

Device	Moisture Sensitivity Level (MSL) Classification
CPC3730C	MSL 1

### ESD Sensitivity



This product is **ESD Sensitive**, and should be handled according to the industry standard **JESD-625**.

### Soldering Profile

Provided in the table below is the Classification Temperature ( $T_c$ ) of this product and the maximum dwell time the body temperature of this device may be ( $T_c - 5$ )°C or greater. The classification temperature sets the Maximum Body Temperature allowed for this device during lead-free reflow processes. For through-hole devices, and any other processes, the guidelines of **J-STD-020** must be observed.

Device	Classification Temperature ( $T_c$ )	Dwell Time ( $t_p$ )	Max Reflow Cycles
CPC3730C	260°C	30 seconds	3

### Board Wash

IXYS Integrated Circuits Division recommends the use of no-clean flux formulations. Board washing to reduce or remove flux residue following the solder reflow process is acceptable provided proper precautions are taken to prevent damage to the device. These precautions include, but are not limited to: using a low pressure wash and providing a follow up bake cycle sufficient to remove any moisture trapped within the device due to the washing process. Due to the variability of the wash parameters used to clean the board, determination of the bake temperature and duration necessary to remove the moisture trapped within the package is the responsibility of the user (assembler). Cleaning or drying methods that employ ultrasonic energy may damage the device and should not be used. Additionally, the device must not be exposed to flux or solvents that are Chlorine- or Fluorine-based.



## MECHANICAL DIMENSIONS

### CPC3730C

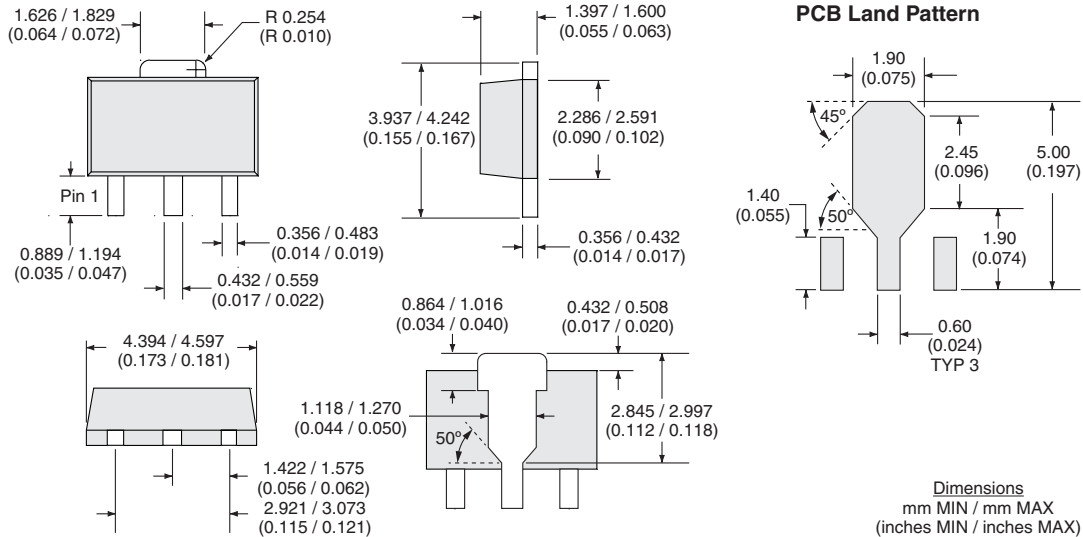

### CPC3730CTR Tape & Reel

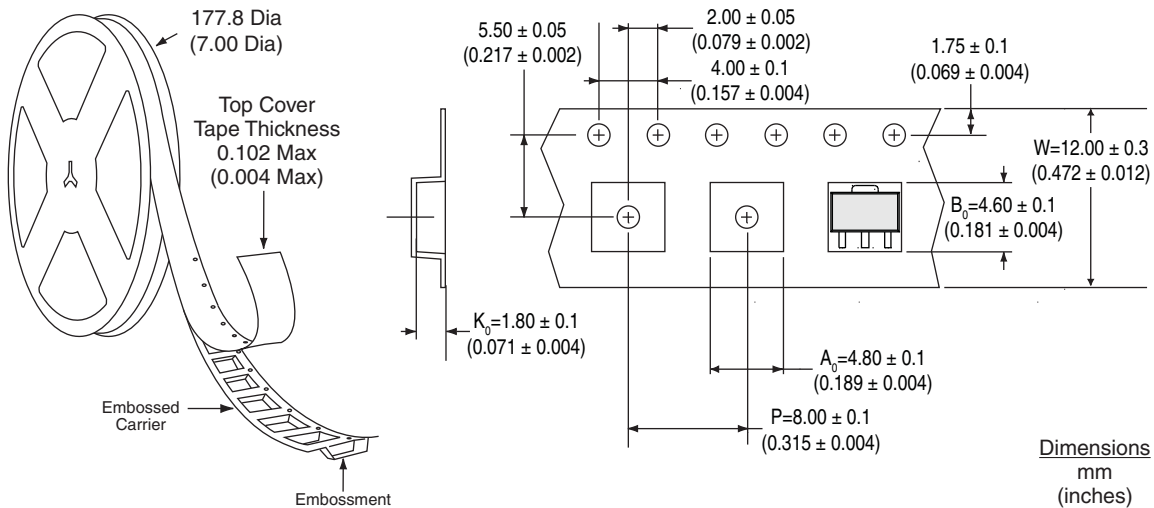

For additional information please visit our website at: [www.ixysic.com](http://www.ixysic.com)

IXYS Integrated Circuits Division makes no representations or warranties with respect to the accuracy or completeness of the contents of this publication and reserves the right to make changes to specifications and product descriptions at any time without notice. Neither circuit patent licenses nor indemnity are expressed or implied. Except as set forth in IXYS Integrated Circuits Division's Standard Terms and Conditions of Sale, IXYS Integrated Circuits Division assumes no liability whatsoever, and disclaims any express or implied warranty, relating to its products including, but not limited to, the implied warranty of merchantability, fitness for a particular purpose, or infringement of any intellectual property right.

The products described in this document are not designed, intended, authorized or warranted for use as components in systems intended for surgical implant into the body, or in other applications intended to support or sustain life, or where malfunction of IXYS Integrated Circuits Division's product may result in direct physical harm, injury, or death to a person or severe property or environmental damage. IXYS Integrated Circuits Division reserves the right to discontinue or make changes to its products at any time without notice.



Компания «ЭлектроПласт» предлагает заключение долгосрочных отношений при поставках импортных электронных компонентов на взаимовыгодных условиях!

Наши преимущества:

- Оперативные поставки широкого спектра электронных компонентов отечественного и импортного производства напрямую от производителей и с крупнейших мировых складов;
- Поставка более 17-ти миллионов наименований электронных компонентов;
- Поставка сложных, дефицитных, либо снятых с производства позиций;
- Оперативные сроки поставки под заказ (от 5 рабочих дней);
- Экспресс доставка в любую точку России;
- Техническая поддержка проекта, помощь в подборе аналогов, поставка прототипов;
- Система менеджмента качества сертифицирована по Международному стандарту ISO 9001;
- Лицензия ФСБ на осуществление работ с использованием сведений, составляющих государственную тайну;
- Поставка специализированных компонентов (Xilinx, Altera, Analog Devices, Intersil, Interpoint, Microsemi, Aeroflex, Peregrine, Syfer, Eurofarad, Texas Instrument, Miteq, Cobham, E2V, MA-COM, Hittite, Mini-Circuits, General Dynamics и др.);

Помимо этого, одним из направлений компании «ЭлектроПласт» является направление «Источники питания». Мы предлагаем Вам помощь Конструкторского отдела:

- Подбор оптимального решения, техническое обоснование при выборе компонента;
- Подбор аналогов;
- Консультации по применению компонента;
- Поставка образцов и прототипов;
- Техническая поддержка проекта;
- Защита от снятия компонента с производства.



#### Как с нами связаться

**Телефон:** 8 (812) 309 58 32 (многоканальный)

**Факс:** 8 (812) 320-02-42

**Электронная почта:** [org@eplast1.ru](mailto:org@eplast1.ru)

**Адрес:** 198099, г. Санкт-Петербург, ул. Калинина, дом 2, корпус 4, литера А.