

PLC-RS.../21

PLC INTERFACE With PDT Relay, Universal Version

INTERFACE

Data Sheet
101780_en_02

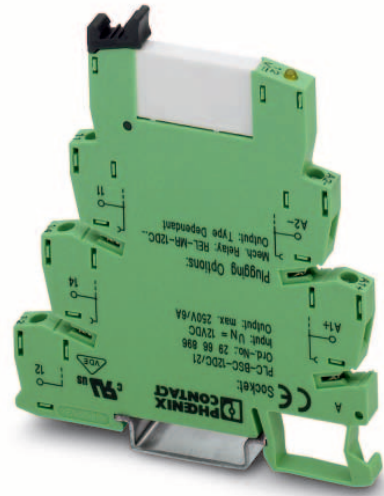

© PHOENIX CONTACT - 03/2008

1 Description

PLC-RS.../21 relay modules, which can be used universally, comprise 6.2 mm basic terminal blocks and plug-in miniature relays with PDT contact and screw or spring-cage connection.

1.1 PDT Offers a High Degree of Flexibility

The PLC-RS.../21 universal PDT module is used whenever an application requires a high degree of flexibility. It can be used either as an input or output module or in N/O, N/C or PDT contact applications.

This offers the advantage of fewer ordering and warehousing items. PLC INTERFACE modules are supplied fully equipped with a relay as standard.

1.2 Input Voltages From 12 V to 230 V

PLC-RS.../21 is available on the coil side in all common industrial voltages from 12 V to 230 V. A further advantage is the ready-integrated input circuit. It consists of a status indicator as well as free-wheeling diode and polarity reversal protection function, and ensures that the operating state is displayed clearly, also offering reliable EMI suppression for the coils and preventing destruction should the polarity be accidentally reversed.

1.3 Optimum Use of Plug-In Bridges

The PLC INTERFACE module achieves maximum efficiency with the user-friendly FBST plug-in bridge system. The PLC-RS.../21 makes effective use of the bridging options for the A1/A2 connection on the coil side and for the grouped power supply at connection 11 on the contact side. Especially effective here are the 500 mm long color-insulated continuous plug-in bridges that can easily be cut to the required length and quickly inserted in the bridge shafts. They eliminate the need for complicated and time-consuming loop bridges.

1.4 Additional Advantages

- Operational safety with RT III (IP67)-protected mechanics
- Environmentally friendly, cadmium-free power contact material for loads up to 250 V AC/6 A
- Available with gold coating for low power levels (mA) as an option
- Integrated input circuit
- Relay can be replaced using an engagement lever
- Safe isolation according to DIN EN 50178
- Inflammability class V0 according to UL94





Make sure you always use the latest documentation.
It can be downloaded at www.download.phoenixcontact.com.
A conversion table is available on the Internet at
www.download.phoenixcontact.com/general/7000_en_00.pdf.



This data sheet is valid for all products listed on the following page:



2 Ordering Data

PLC INTERFACE With Screw Connection

| Description | Type | Order No. | Pcs./Pck. | |
|---|--------------------------------|-------------------|-----------|----|
| PLC INTERFACE With Multi-Layer Contact Relay, Universal Version | | | | |
| PLC INTERFACE, comprising PLC-BSC.../21 basic terminal block and plug-in miniature relay (see INTERFACE catalog), for mounting on  | 12 V DC | PLCRSC- 12DC/21AU | 2966919 | 10 |
| | 24 V DC | PLCRSC- 24DC/21AU | 2966265 | 10 |
| | 24 V AC/DC | PLCRSC- 24UC/21AU | 2966278 | 10 |
| | 48 V DC | PLCRSC- 48DC/21AU | 2966126 | 10 |
| | 60 V DC | PLCRSC- 60DC/21AU | 2966142 | 10 |
| | 120 V AC/110 V DC | PLCRSC-120UC/21AU | 2966281 | 10 |
| | 230 V AC/220 V DC ¹ | PLCRSC-230UC/21AU | 2966294 | 10 |
| PLC INTERFACE With Power Contact Relay, Universal Version | | | | |
| PLC INTERFACE, comprising PLC-BSC.../21 basic terminal block and plug-in miniature relay (see INTERFACE catalog), for mounting on  | 12 V DC | PLCRSC- 12DC/21 | 2966906 | 10 |
| | 24 V DC | PLCRSC- 24DC/21 | 2966171 | 10 |
| | 24 V AC/DC | PLCRSC- 24UC/21 | 2966184 | 10 |
| | 48 V DC | PLCRSC- 48DC/21 | 2966113 | 10 |
| | 60 V DC | PLCRSC- 60DC/21 | 2966139 | 10 |
| | 120 V AC/110 V DC | PLCRSC-120UC/21 | 2966197 | 10 |
| | 230 V AC/220 V DC ¹ | PLCRSC-230UC/21 | 2966207 | 10 |

¹ The PLC-ATP BK insulating plate must be installed for voltages greater than 250 V (L1, L2, L3) between the same terminal points on adjacent modules (see "Accessories"). FBST 8-PLC... or FBST 500... is then used for potential bridging.

PLC INTERFACE With Spring-Cage Connection

| Description | Type | Order No. | Pcs./Pck. | |
|---|--------------------------------|-------------------|-----------|----|
| PLC INTERFACE With Multi-Layer Contact Relay, Universal Version | | | | |
| PLC INTERFACE, comprising PLC-BSC.../21 basic terminal block and plug-in miniature relay (see INTERFACE catalog), for mounting on  | 12 V DC | PLCRSP- 12DC/21AU | 2967442 | 10 |
| | 24 V DC | PLCRSP- 24DC/21AU | 2966540 | 10 |
| | 24 V AC/DC | PLCRSP- 24UC/21AU | 2966553 | 10 |
| | 48 V DC | PLCRSP- 48DC/21AU | 2966566 | 10 |
| | 60 V DC | PLCRSP- 60DC/21AU | 2966579 | 10 |
| | 120 V AC/110 V DC | PLCRSP-120UC/21AU | 2966582 | 10 |
| | 230 V AC/220 V DC ¹ | PLCRSP-230UC/21AU | 2966647 | 10 |
| PLC INTERFACE With Power Contact Relay, Universal Version | | | | |
| PLC INTERFACE, comprising PLC-BSC.../21 basic terminal block and plug-in miniature relay (see INTERFACE catalog), for mounting on  | 12 V DC | PLCRSP- 12DC/21 | 2967439 | 10 |
| | 24 V DC | PLCRSP- 24DC/21 | 2966472 | 10 |
| | 24 V AC/DC | PLCRSP- 24UC/21 | 2966485 | 10 |
| | 48 V DC | PLCRSP- 48DC/21 | 2966498 | 10 |
| | 60 V DC | PLCRSP- 60DC/21 | 2966511 | 10 |
| | 120 V AC/110 V DC | PLCRSP-120UC/21 | 2966524 | 10 |
| | 230 V AC/220 V DC ¹ | PLCRSP-230UC/21 | 2966537 | 10 |

¹ The PLC-ATP BK insulating plate must be installed for voltages greater than 250 V (L1, L2, L3) between the same terminal points on adjacent modules (see "Accessories"). FBST 8-PLC... or FBST 500... is then used for potential bridging.



With the 120 V and 230 V modules, an REL-MR-60DC/... 60 V relay is normally used due to the input circuit integrated in the basic terminal block. For the protection of input and output, inductive loads must be dampened with an effective protective circuit.

Accessories

| Description | Type | Order No. | Pcs./Pck. |
|------------------|------------|-----------|-----------|
| Insulating plate | PLC-ATP BK | 2966841 | 25 |



The PLC-ATP BK insulating plate should be used in the following cases: always fit at the start and end of a PLC terminal strip for voltages greater than 250 V (L1, L2, L3) between the same terminal points on adjacent modules (FBST 8-PLC... or FBST 500... can be used for potential bridging) and for safe isolation between adjacent modules.

For additional accessories such as power terminal blocks and plug-in bridges, please refer to the INTERFACE catalog or www.phoenixcontact.com.

3 Technical Data

| Input Data | ...24DC... | ...24UC... | ...120UC... | ...230UC... |
|--|--|------------------------------|-----------------------|-----------------------|
| Nominal input voltage ¹ | 24 V DC | 24 V AC/DC | 120 V AC/ 110 V DC | 230 V AC/ 220 V DC |
| Permissible range (with reference to U_N) | See "Operating Voltage Ranges" on page 5 | | | |
| Typical input current at U_N | 9 mA | 11 mA/8.5 mA | 3.5 mA/3 mA | 3 mA |
| Typical response time at U_N | 4 ms | 6 ms | 6 ms | 7 ms |
| Typical release time at U_N | 8 ms | 15 ms | 15 ms | 15 ms |
| Input circuit | Yellow LED, protection against polarity reversal, free- wheeling diode | Yellow LED, bridge rectifier | | |

¹ The PLC-ATP BK insulating plate must be installed for voltages greater than 250 V (L1, L2, L3) between the same terminal points on adjacent modules (see "Accessories"). FBST 8-PLC... or FBST 500... is then used for potential bridging.

| Output Data | PLC-...21 | PLC-...21AU |
|-----------------------------|----------------------------|--------------------------------|
| Contact type | Single contact, SPDT | |
| Contact material | AgSnO | AgSnO + 5 μ A ¹ |
| Maximum switching voltage | 250 V AC/DC ² | 30 V AC/36 V DC |
| Minimum switching voltage | 12 V AC/DC | 100 mV |
| Limiting continuous current | 6 A | 50 mA |
| Maximum inrush current | 30 A (for AC 15 operation) | 50 mA |
| Minimum switching current | 10 mA | 1 mA |
| Maximum shutdown power | Ohmic load $\tau = 0$ ms | Ohmic load $\tau = 0$ ms |
| | 24 V DC | 140 W |
| | 48 V DC | 20 W |
| | 60 V DC | 18 W |
| | 110 V DC | 23 W |
| | 220 V DC | 40 W |
| | 250 V AC | 1500 VA |
| Minimum switching power | 120 mW | 10 μ W |

¹ If the specified maximum values are exceeded, the gold coating will be damaged. In subsequent operation, the AgSnO contact values given here will apply. This can then result in reduced service life, similar to dedicated power contacts.

² The PLC-ATP BK insulating plate must be installed for voltages greater than 250 V (L1, L2, L3) between the same terminal points on adjacent modules (see "Accessories"). FBST 8-PLC... or FBST 500... is then used for potential bridging.

General Data

| | |
|---|--|
| Impulse voltage withstand level | 4 kV, 50 Hz, 1 min. |
| Ambient temperature range | |
| Operation | -25°C ... 60°C (230 V type -25°C ... 55°C) |
| Storage/transport | -40°C ... 85°C |
| Nominal operating mode | 100% operating factor |
| Inflammability class according to UL 94 (housing) | V0 |
| Mechanical service life | 2 x 10 ⁷ cycles |

General Data (Continued)

| | |
|--|---|
| Air and creepage distances between the circuits ¹ | IEC 60664, IEC 60664 A, DIN VDE 0110, DIN EN 50178/VDE 0106-160, IEC 60255/DIN VDE 0435 |
| Pollution degree | 3 |
| Surge voltage category | III |
| Mounting position | Any |
| Mounting | Can be aligned without spacing |
| Conductor cross-section | |
| Solid, with screw connection | 0.14 mm ² ... 2.5 mm ² (26 - 14 AWG) |
| Stranded, with screw connection | 0.14 mm ² ... 1.5 mm ² (26 - 14 AWG) |
| Solid, with spring-cage connection | 0.2 mm ² ... 2.5 mm ² (24 - 14 AWG) |
| Stranded, with spring-cage connection | 0.2 mm ² ... 1.5 mm ² (24 - 14 AWG) |
| Stripping length | |
| Screw connection | 10 mm |
| Spring-cage connection | 8 mm |
| Dimensions (W x H x D) | 6.2 mm x 94 mm x 80 mm |
| Housing material | Polyamide PA, green |

¹ The PLC-ATP BK insulating plate must be installed for safe isolation between adjacent modules (see "Accessories"). FBST 8-PLC... or FBST 500... is then used for potential bridging.

Tests/Approvals

| | |
|----|-------------------------------------|
| CE | CE |
| UL | UL [®] cUL [®] US |
| GL | GL |

4 Block Diagram

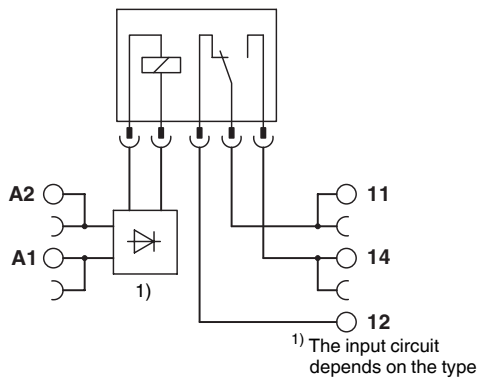

5 Operating Voltage Ranges

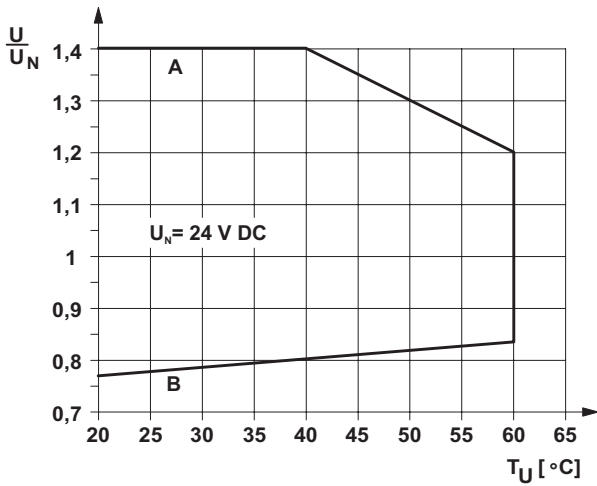

Figure 1 Operating voltage range for 24 V DC

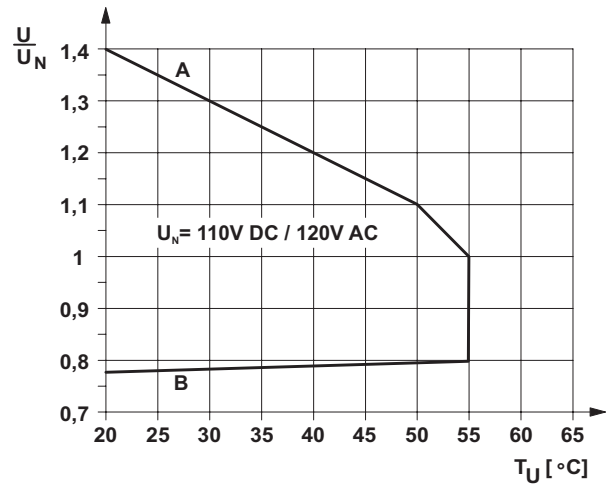

Figure 3 Operating voltage range for 120 V AC/DC

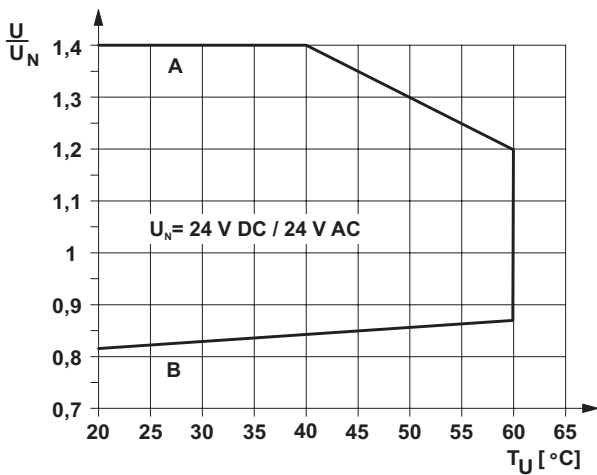

Figure 2 Operating voltage range for 24 V AC/DC

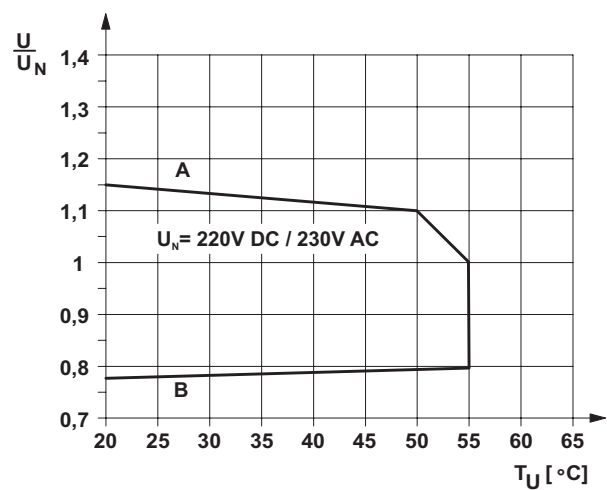

Figure 4 Operating voltage range for 230 V AC/DC

General Conditions

Direct alignment in the block, all devices 100% operating factor, horizontal or vertical mounting.

Curve A

Maximum permissible continuous voltage U_{max} with limiting continuous current on the contact side

Curve B

Minimum permissible operate voltage U_{op} following pre-excitation



Компания «ЭлектроПласт» предлагает заключение долгосрочных отношений при поставках импортных электронных компонентов на взаимовыгодных условиях!

Наши преимущества:

- Оперативные поставки широкого спектра электронных компонентов отечественного и импортного производства напрямую от производителей и с крупнейших мировых складов;
- Поставка более 17-ти миллионов наименований электронных компонентов;
- Поставка сложных, дефицитных, либо снятых с производства позиций;
- Оперативные сроки поставки под заказ (от 5 рабочих дней);
- Экспресс доставка в любую точку России;
- Техническая поддержка проекта, помощь в подборе аналогов, поставка прототипов;
- Система менеджмента качества сертифицирована по Международному стандарту ISO 9001;
- Лицензия ФСБ на осуществление работ с использованием сведений, составляющих государственную тайну;
- Поставка специализированных компонентов (Xilinx, Altera, Analog Devices, Intersil, Interpoint, Microsemi, Aeroflex, Peregrine, Syfer, Eurofarad, Texas Instrument, Miteq, Cobham, E2V, MA-COM, Hittite, Mini-Circuits, General Dynamics и др.);

Помимо этого, одним из направлений компании «ЭлектроПласт» является направление «Источники питания». Мы предлагаем Вам помощь Конструкторского отдела:

- Подбор оптимального решения, техническое обоснование при выборе компонента;
- Подбор аналогов;
- Консультации по применению компонента;
- Поставка образцов и прототипов;
- Техническая поддержка проекта;
- Защита от снятия компонента с производства.



Как с нами связаться

Телефон: 8 (812) 309 58 32 (многоканальный)

Факс: 8 (812) 320-02-42

Электронная почта: org@eplast1.ru

Адрес: 198099, г. Санкт-Петербург, ул. Калинина, дом 2, корпус 4, литера А.