



## FEATURES

- Cermet resistive element.
- IP54 protection according to IEC 60529.
- Plastic material according to UL94V-0.
- Alumina substrate.
- Also upon request:
  - Low torque version.
  - Available as SPDT switch.
  - Laser trimming for tighter tolerances.
  - Wiper positioned at initial, 50% or fully clockwise.
  - Supplied in magazines for automatic insertion.
  - Long life model for low cost control applications.
  - Special tapers.
  - Mechanical detents.

## MECHANICAL SPECIFICATIONS

- Mechanical rotation angle:  $235^\circ \pm 5^\circ$
- Electrical rotation angle:  $220^\circ \pm 20^\circ$
- Torque: 0.4 to 2 Ncm. (0.6 to 2.7 in-oz)
- Stop torque: > 5 Ncm. (>7 in-oz)
- Life\*: Up to 10K cycles

## ELECTRICAL SPECIFICATIONS

- Range of values\*:  $100\Omega \leq R_n \leq 5\text{ M}$  (Decad. 1.0 - 2.0 - 2.2 - 2.5 - 4.7 - 5.0)
- Tolerance\*:  $100\Omega \leq R_n \leq 1\text{M}\Omega$  .....  $\pm 20\%$   
 $1\text{M}\Omega < R_n \leq 5\text{M}\Omega$  .....  $\pm 30\%$
- Max. Voltage: 200 VDC (lin) 100 VDC (no lin)
- Nominal Power 70°C (158°F) (see power rating curve)  
 0.33 W (lin) 0.17 W (no lin)
- Taper\* (Log. & Alog. only  $R_n \geq 1\text{K}$ ) Lin ; Log; Alog.
- Residual resistance\*:  $\leq 0.5\% R_n$  (5Ω min.)
- Equivalent Noise Resistance:  $\leq 3\% R_n$  (3Ω min.)
- Operating temperature: standard: -40°C to +90°C (-40°F to +194°F)  
 upon request: -40°C to +120°C (-40°F to +248°F)

\* Others check availability

## HOW TO ORDER

PTC-10 L H01 101 A 2020		OPTIONAL EXTRAS										
<b>Series</b>	<b>Code</b>	<b>Mounting Method</b>	<b>Taper</b>	<b>Value</b>	<b>Tolerance</b>	<b>Life</b>	<b>Magazine</b>	<b>Detents</b>	<b>Shaft / Thum.</b>	<b>Shaft / rotor colour</b>	<b>Torque</b>	<b>Wiper position</b>
PTC-10	H01 H05 H02 H10 V05 V10 V11 V13	H2.5 H5 H2.5P H5P V5 VP VJ	A = Lin. B = Log. C = Alog.	101 = 100Ω 504 = 500 K 505 = 5 M 000 = C M	0505 = ± 5% 0707 = ± 7% 1010 = ± 10% 2020 = ± 20% 3030 = ± 30%	E = Long life (See note 5)	T (See note 6)	PAI PAM PAF P11 P1F P02 ... P16	01 = Fig. 1 02 = Fig. 2 ... 17 = Fig. 17 (See note 9)	AM = Yellow AZ = Blue BL = White CR = Cream GR = Grey MA = Brown NA = Orange NE = Black RO = Red VE = Green VI = Violet (See note 7)	- = Standard L = Low Torque (See note 8)	PM = 50% PF = Final
<b>Rotors</b>	(See note 2)			(See note 3)	(See note 4)							
B G K L M R W X Y Z												
(See note 1)												

### NOTES:

- (1) "Z" adjustment only available on "H" versions. Rotor "G" only available in purple (shaft/rotor colour "VI").
- (2) Terminal styles: "P" & "J" are crimped terminals. V=Vertical adjust; H=Horizontal Adjust
- (3) Value Example: Code: 10 1 = 100 Ω  
 ↳ Num of zeros  
 ↳ First two digits of the value.
- (4) Non standard tolerance, check Example: +7% Code: 07 05  
 ↳ negative tolerance  
 ↳ positive tolerance
- (5) • Standard = 1000 cycles • Long = 10K cycles  
 Others check availability.
- (6) Magazines: not available with the H10, V05 and V13 models, nor with adjustment types X, W, Y, Z.  
 Non flammable: housing, rotor and shaft.
- (7) Colour shaft/rotor: • Potentiometer without shaft: only rotor • Potentiometer with shaft: only shaft
- (8) Low Torque:  $\leq 1\text{ Ncm}$   
 No detent option available for low torque models.
- (9) If you want to use your own custom plastic shaft/knob/actuator please contact Piher for advice about compatible materials.

## HOW TO ORDER CUSTOM DRAWING

PTC-10 LH 01 + DRAWING NUMBER (Max. 16 characters)

This way of ordering should be used for options which are not included in the "How to order" standard and optional extras.

## STANDARD OPTIONS

Detents .....	None
Packing .....	Bulk
Rotor colour .....	Natural
Shaft colour .....	Natural
Wiper position .....	Initial
Torque .....	Standard
Life .....	1000 cycles

## ROTORS

Rotors (Default delivery is at initial position. Wipers are shown positioned at 50% for the picture)

Without shaft or knob.

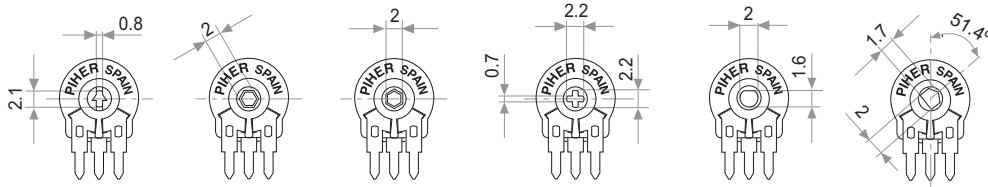

**L** = Screwdriver    **M** = Hexagonal    **G** = Hexagonal    **K** = Cross slot    **R**    **B**

All rotors are thru-hole.

With inserted shaft.

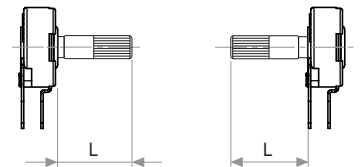

**X** = Adjustable from collector side

**W** = Adjustable from terminal side

## With knob/humbwheel inserted

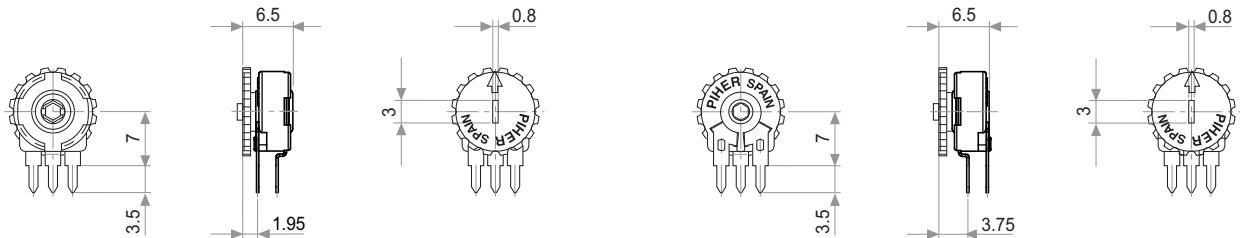

**Y** = Adjustable from terminal side (default knob is 5034).

**Z** = Adjustable from collector side (default knob is 5034).

## MOUNTING METHODS

V = horizontal mounting – vertical adjustment

H = vertical mounting – horizontal adjustment

### V05

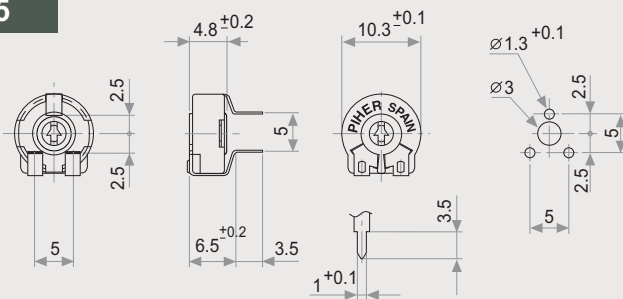

### V10

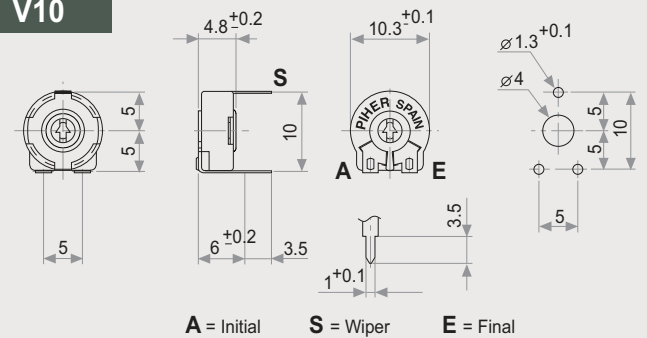

**A** = Initial    **S** = Wiper    **E** = Final

### V11

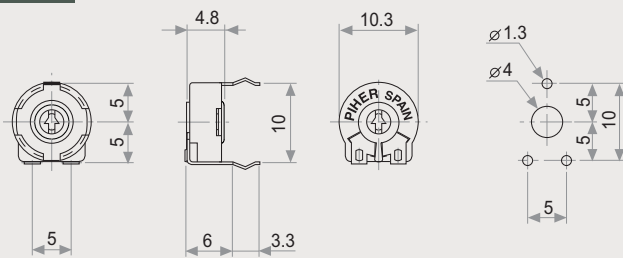

### V13

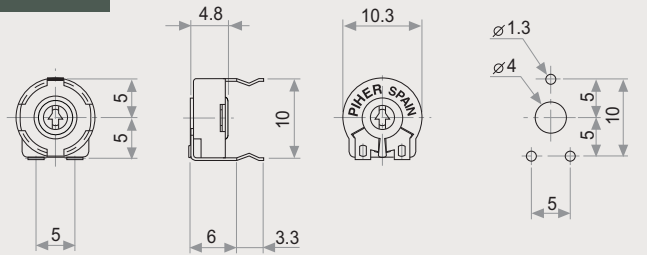

Download 3D - STEP files here: <https://piher.net/piher/?p=913>

## ROTORS

V = horizontal mounting – vertical adjustment

H = vertical mounting – horizontal adjustment



### Crimped terminals - detail

V11, V13, H02, H10 models feature "crimped" terminals that provide greater stability during the soldering process.

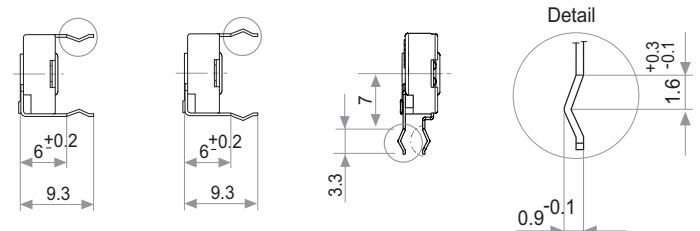

## OPTIONS



**SW Standard specs.**  
 Power Rating:  
 24V / 15mA  
 ON position resistance:  
 ≤ 5 Ω  
 Insulation Resistance:  
 ≥ 30 MΩ  
 Please contact Piher  
 for ordering information.

## TAPERS

A = Linear  
B = Log.  
C = Alog.



Standard



Special example



Std. Position = CCW

NOTE = Please note relative terminal positions when ordering non linear tapers.

## TESTS

## TYPICAL VARIATIONS

ELECTRICAL LIFE	1.000 h. @ 70°C; 0.33 W	±5 %
MECHANICAL LIFE (CYCLES)	1000 @ 10 CPM ...15 CPM	±2 % (Rn < 1 MΩ)
TEMPERATURE COEFFICIENT	-40°C; +90°C	±100 ppm (Rn <100 K)
THERMAL CYCLING	16 h. @ 90°C; 2h. @ -40°C	±2.5 %
DAMP HEAT	500 h. @ 40°C @ 95% HR	±5 %
VIBRATION (for each plane X,Y,Z)	2 h. @ 10 Hz. ... 55 Hz.	±2 %

NOTE: Out of range values may not comply these results.

## PACKAGING

### BOXES

Model	Units
Without shaft	1000 (80 x 85 x 185 mm.)
With thumbwheel	800 (80 x 85 x 185 mm.)
With shaft	400 (80 x 85 x 185 mm.)



Magazines for PTC-10 h 2.5; h 5  
Also crimped term. h 2.5 P

### AUTOMATIC INSERTION

Magazines	Units
PTC-10H & PTC-10V	50 Pieces



Magazines for PTC-10 V  
Also crimped term. VP

## POWER RATING CURVE



## SHAFTS (for G and M rotor types, top view)

Shafts, knobs & thumbwheels are delivered at random position. Positioning available check availability.



Fig. 1 / Ref. 5016



Fig. 2 / Ref. 5053



Fig. 3 / Ref. 5012



Fig. 4 / Ref. 6053



Fig. 6 / Ref. 5035



Fig. 7 / Ref. 5115



Fig. 8 / Ref. 5116

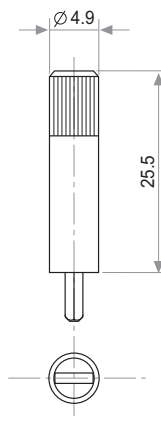

Fig. 9 / Ref. 5119

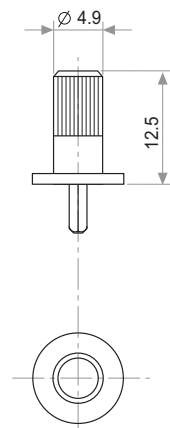

Fig. 10 / Ref. 5120



Fig. 12 / Ref. 6052



Fig. 14 / Ref. 5055



Fig. 18 / Ref. 6064

## THUMBWHEELS (for G and M rotor types, top view)

Shafts, knobs & thumbwheels are delivered at random position. Positioning available check availability.



Fig. 5 / Ref. 5034



Fig. 15 / Ref. 6008



Fig. 16 / Ref. 5039

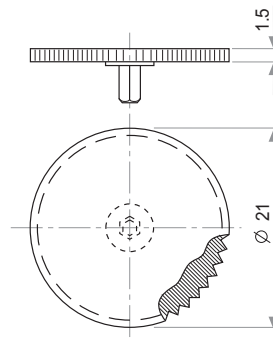

Fig. 17 / Ref. 5062

## THUMBWHEEL For R rotor type only

Marking: configurable number of positions.

Example of four positions marking:



check availability

## DETENT CONFIGURATIONS EXAMPLES

This innovative PT's with detents family has been specifically developed to allow the integration of otherwise large and expensive external mechanisms into the body of the majority of the 10 & 15 mm. PS/PT/PTC potentiometer series thus allowing a high range of configurations: special tapers, torque, tolerances, linearity, cut track, etc.

This detent design not only adds a "click" sensation of position, but also offers enormous savings in both cost and space for any given application.

Strong and weak detents can be mixed as per customer's request.

Detent number and positions can be made or fitted to the customer needs or preferences.

 Relative detent positions along the total mechanical travel. Unless otherwise specified the detents are evenly spaced (using the end points as reference)



### NOTES FOR DETENTED VERSIONS:

- (1) Detents not available for V05 mounting. These cases are studied individually.
- (2) For more than 10 detents versions please contact your nearest PIHER authorised distributor.
- (3) Standard mechanical life is 500 cycles.
- (4) Long life versions are available under request and have the following characteristics at T<sup>a</sup>:
  - Potentiometers with 1 to 3 detents: up to 10K cycles
  - Potentiometers with 4 and more detents: up to 5K cycles
- (5) Detent torque can vary from 1.2 to 2.5 times the standard potentiometer torque.
- (6) Please consult your nearest Piher supplier if unique non-overlapping values at each detent position or LOG/ALOG tapers are required.
- (7) Different output voltage values can be matched at each detent position (upon request).

Detents detail.  
(7 detents example)



For custom voltage outputs in any detent position see next page.

## STEPPED OUTPUTS

Constant value zones can be combined with strategically located stops matching the flat areas of the output. If you require this feature, please, send us your requirements to [sales@piher.net](mailto:sales@piher.net)

### Stepped outputs version example (10 steps version):



when the potentiometer's wiper position is located at detent n°9, the output voltage will be 88.9% Un ± % tolerance.



### Improved repeatability

By combining the constant value zones with the detents, engineers can align the same voltage values with each of the detent stops when rotating the control both forward and backward.

This provides clear mechanical positions that are not only repeatable, but perfectly aligned electrical outputs at each of the (detent) angles.

Piher's detents also prevent output values from changing due to vibration or accidental rotor movements, furthering reliable control consistency.



PIHER's potentiometers can feature special stepped outputs or 'constant voltage zones' for the 10mm and 15mm product families.

These constant voltage zones can be combined with PIHER's mechanical detents to provide exact alignment between the electrical output (flat areas) and the mechanical detent position. The result is a higher level of precision in controlling lighting, temperature, motor or other electronic control systems.

In addition to established catalogue detent configurations, we will design and manufacture any other configuration on our tried-and-tested carbon/cermet & THM/SMD potentiometer technology and processes.

With its precise control capabilities, our 10mm and 15mm potentiometers series are well suited for many consumer applications such as lighting (dimmers), power hand tools, relays, timers and HVAC systems.

### Design tip. Cost-effectiveness

Absolute encoders can easily be replaced connecting the potentiometer to the microprocessor's analogue input.



### Main advantages

- ✓ Unique, non-overlapping values at each step (detent position)
- ✓ It prevents changes in the output value due to light vibration or accidental rotor micro-movements
- ✓ Fully customisable according to customer's needs
- ✓ Cost effective replacement for absolute encoders

## RECOMMENDED CONNECTIONS

Piher potentiometer's recommended connection circuit for a position sensor or control application. (voltage divider circuit electronic design).



## Disclaimer

The product information in this catalogue is for reference purposes. Please consult for the most up to date and accurate design information.

Piher Sensors & Controls S.A., its affiliates, agents, and employees, and all persons acting on its or their behalf (collectively, "Piher"), disclaim any and all liability for any errors, inaccuracies or incompleteness contained herein or in any other disclosure relating to any product described herein.

Piher disclaims any and all liability arising out of the use or application of any product described herein or of any information provided herein to the maximum extent permitted by law. The product specifications do not expand or otherwise modify Piher's terms and conditions of sale, including but not limited to the warranty expressed therein, which apply to these products.

No licence, express or implied, by estoppel or otherwise, to any intellectual property rights is granted by this document or by any conduct of Piher.

The products shown herein are not designed for use in medical, life-saving, or life-sustaining applications unless otherwise expressly indicated. Customers using or selling Piher products not expressly indicated for use in such applications do so entirely at their own risk and agree to fully indemnify Piher for any damages arising or resulting from such use or sale. Please contact authorised Piher personnel to obtain written terms and conditions regarding products designed for such applications.

Product names and markings noted herein may be trademarks of their respective owners.

Information contained in and/or attached to this catalogue may be subject to export control regulations of the European Community, USA, or other countries. Each recipient of this document is responsible to ensure that usage and/or transfer of any information contained in this document complies with all relevant export control regulations. If you are in any doubt about the export control restrictions that apply to this information, please contact the sender immediately. For any Piher International Corp. Exports, Note: All products / technologies are EAR99 Classified commodities. Exports from the United States are in accordance with the Export Administration Regulations. Diversion contrary to US law is prohibited.

Piher is an Amphenol™ company.



**RoHS**  
compliant

Note: Piher products can be adapted to meet customer's requirements.  
Due to continuous process improvement, specifications are subject to change without notice.

v040719

## Contact

Piher Sensors & Controls SA  
Polígono Industrial Municipal  
Vial T2, 22,  
31500 Tudela - Spain.  
t. +34-948-820450  
f. +34-948-824050

sales@piher.net

www.piher.net





Компания «ЭлектроПласт» предлагает заключение долгосрочных отношений при поставках импортных электронных компонентов на взаимовыгодных условиях!

Наши преимущества:

- Оперативные поставки широкого спектра электронных компонентов отечественного и импортного производства напрямую от производителей и с крупнейших мировых складов;
- Поставка более 17-ти миллионов наименований электронных компонентов;
- Поставка сложных, дефицитных, либо снятых с производства позиций;
- Оперативные сроки поставки под заказ (от 5 рабочих дней);
- Экспресс доставка в любую точку России;
- Техническая поддержка проекта, помощь в подборе аналогов, поставка прототипов;
- Система менеджмента качества сертифицирована по Международному стандарту ISO 9001;
- Лицензия ФСБ на осуществление работ с использованием сведений, составляющих государственную тайну;
- Поставка специализированных компонентов (Xilinx, Altera, Analog Devices, Intersil, Interpoint, Microsemi, Aeroflex, Peregrine, Syfer, Eurofarad, Texas Instrument, Miteq, Cobham, E2V, MA-COM, Hittite, Mini-Circuits, General Dynamics и др.);

Помимо этого, одним из направлений компании «ЭлектроПласт» является направление «Источники питания». Мы предлагаем Вам помощь Конструкторского отдела:

- Подбор оптимального решения, техническое обоснование при выборе компонента;
- Подбор аналогов;
- Консультации по применению компонента;
- Поставка образцов и прототипов;
- Техническая поддержка проекта;
- Защита от снятия компонента с производства.



#### Как с нами связаться

**Телефон:** 8 (812) 309 58 32 (многоканальный)

**Факс:** 8 (812) 320-02-42

**Электронная почта:** [org@eplast1.ru](mailto:org@eplast1.ru)

**Адрес:** 198099, г. Санкт-Петербург, ул. Калинина, дом 2, корпус 4, литера А.