

---

**I<sup>2</sup>C-Compatible (2-Wire) Serial EEPROM**  
**128-Kbit (16,384 x 8)**

---

**DATASHEET**

---

**Features**

---

- Low-voltage and Standard-voltage Operation
  - $V_{CC} = 1.7V$  to 5.5V
- Internally Organized as 16,384 x 8
- 2-wire Serial Interface
- Schmitt Trigger, Filtered Inputs for Noise Suppression
- Bidirectional Data Transfer Protocol
- 400kHz (1.7V) and 1MHz (2.5V, 2.7V, 5.0V) Compatibility
- Write Protect Pin for Hardware Protection
- 64-byte Page Write Mode
  - Partial Page Writes Allowed
- Self-timed Write Cycle (5ms Max)
- High Reliability
  - Endurance: 1,000,000 Write Cycles
  - Data Retention: 40 Years
- Lead-free/Halogen-free Devices Available
- Green Package Options (Pb/Halide-free/RoHS Compliant)
  - 8-lead JEDEC SOIC, 8-lead TSSOP, 8-pad UDFN, 8-pad XDFN, 8-ball VFBGA, and 4-ball WLCSP Packages
- Die Sale Options: Wafer Form, Waffle Pack, and Bumped Wafers

---

**Description**

---

The Atmel® AT24C128C provides 131,072-bits of Serial Electrically Erasable and Programmable Read-Only Memory (EEPROM) organized as 16,384 words of 8 bits each. The device's cascading feature allows up to eight devices to share a common 2-wire bus. The device is optimized for use in many industrial and commercial applications where low-power and low-voltage operation are essential. The devices are available in space-saving 8-lead JEDEC SOIC, 8-lead TSSOP, 8-pad UDFN, 8-pad XDFN, 8-ball VFBGA, and 4-ball WLCSP packages. In addition, this device operates from 1.7V to 5.5V.

# 1. Pin Configurations and Pinouts

**Table 1-1. Pin Configuration**

Pin	Function
A <sub>0</sub>	Address Input
A <sub>1</sub>	Address Input
A <sub>2</sub>	Address Input
GND	Ground
SDA	Serial Data
SCL	Serial Clock Input
WP	Write Protect
V <sub>CC</sub>	Device Power Supply

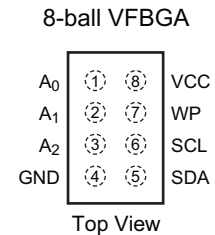
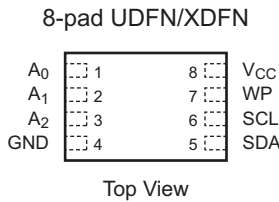
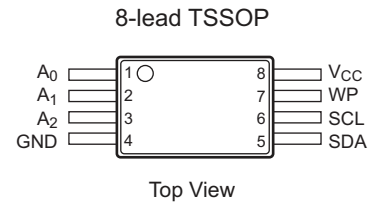
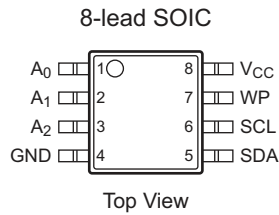

4-ball WLCSP

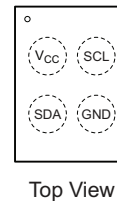

# 2. Absolute Maximum Ratings\*

Operating Temperature . . . . .	-55°C to +125°C
Storage Temperature . . . . .	-65°C to + 150°C
Voltage on any pin with respect to ground . . . . .	-1.0 V +7.0V
Maximum Operating Voltage . . . . .	6.25V
DC Output Current . . . . .	.5.0mA

\*Notice: Stresses beyond those listed under “Absolute Maximum Ratings” may cause permanent damage to the device. This is a stress rating only and functional operation of the device at these or any other conditions beyond those indicated in the operational sections of this specification are not implied. Exposure to absolute maximum rating conditions for extended periods may affect device reliability.

### 3. Block Diagram

Figure 3-1. Block Diagram

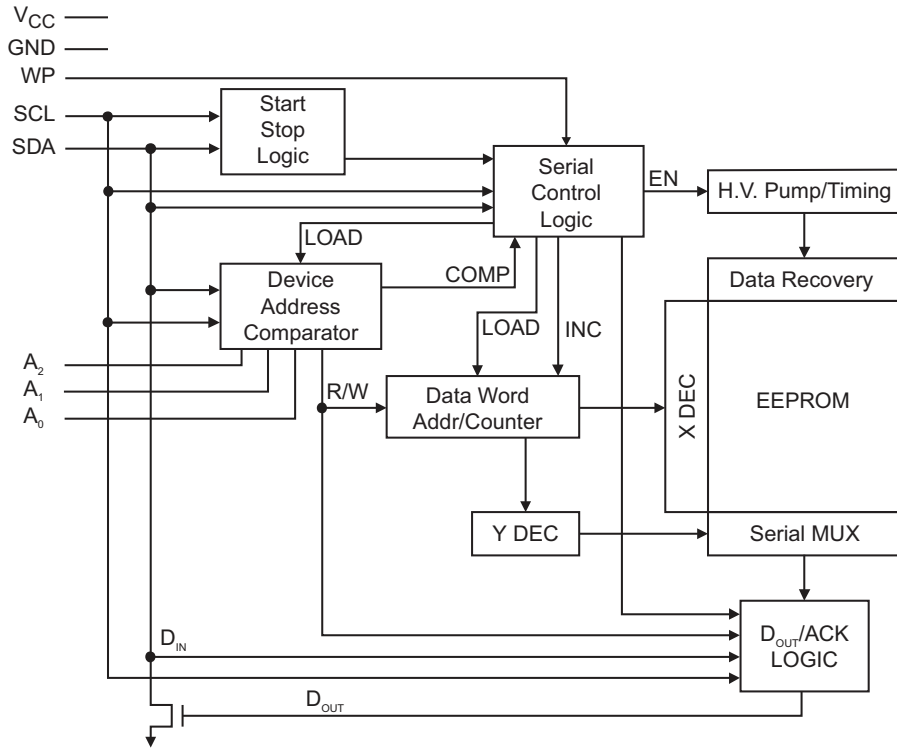

### 4. Pin Descriptions

**Serial Clock (SCL):** The SCL input is used to positive-edge clock data into each EEPROM device and negative-edge clock data out of each device.

**Serial Data (SDA):** The SDA pin is bidirectional for serial data transfer. This pin is open drain driven and may be wire-ORed with any number of other open-drain or open-collector devices.

**Device Addresses (A<sub>2</sub>, A<sub>1</sub>, A<sub>0</sub>):** The A<sub>2</sub>, A<sub>1</sub>, and A<sub>0</sub> pins are device address inputs that are hard wired (directly to GND or to V<sub>CC</sub>) for compatibility with other Atmel AT24C devices. When the pins are hard wired, as many as eight 128K devices may be addressed on a single bus system. (Device addressing is discussed in detail in [Section 7. “Device Addressing” on page 9](#)). A device is selected when a corresponding hardware and software match is true. If these pins are left floating, the A<sub>2</sub>, A<sub>1</sub>, and A<sub>0</sub> pins will be internally pulled down to GND. However, due to capacitive coupling that may appear during customer applications, Atmel recommends always connecting the address pins to a known state. When using a pull-up resistor, Atmel recommends using 10kΩ or less.

**Write Protect (WP):** The Write Protect input, when connected to GND, allows normal write operations. When WP is connected directly to V<sub>CC</sub>, all write operations to the memory are inhibited. If the pin is left floating, the WP pin will be internally pulled down to GND. However, due to capacitive coupling that may appear during customer applications, Atmel recommends always connecting the WP pins to a known state. When using a pull-up resistor, Atmel recommends using 10kΩ or less.

Table 4-1. Write Protect

WP Pin Status	Part of the Array Protected
At V <sub>CC</sub>	Full Array
At GND	Normal Read/Write Operations

## 5. Memory Organization

**AT24C128C, 128K Serial EEPROM:** The 128K is internally organized as 256 pages of 64-bytes each. Random word addressing requires a 14-bit data word address.

### 5.1 Pin Capacitance

**Table 5-1. Pin Capacitance<sup>(1)</sup>**

Applicable over recommended operating range from:  $T_A = 25^\circ\text{C}$ ,  $f = 1.0\text{MHz}$ ,  $V_{CC} = 1.7\text{V}$  to  $5.5\text{V}$ .

Symbol	Test Condition	Max	Units	Conditions
$C_{I/O}$	Input/Output Capacitance (SDA)	8	pF	$V_{I/O} = 0\text{V}$
$C_{IN}$	Input Capacitance ( $A_0$ , $A_1$ , $A_2$ , and SCL)	6	pF	$V_{IN} = 0\text{V}$

Note: 1. This parameter is characterized and is not 100% tested.

### 5.2 DC Characteristics

**Table 5-2. DC Characteristics**

Applicable over recommended operating range from:  $T_{AI} = -40^\circ\text{C}$  to  $+85^\circ\text{C}$ ,  $V_{CC} = 1.7\text{V}$  to  $5.5\text{V}$  (unless otherwise noted).

Symbol	Parameter	Test Condition		Min	Typ	Max	Units
$V_{CC1}$	Supply Voltage			1.7		5.5	V
$I_{CC1}$	Supply Current	$V_{CC} = 5.0\text{V}$	Read at 400kHz		1.0	2.0	mA
$I_{CC2}$	Supply Current	$V_{CC} = 5.0\text{V}$	Write at 400kHz		2.0	3.0	mA
$I_{SB1}$	Standby Current	$V_{CC} = 1.7\text{V}$	$V_{IN} = V_{CC}$ or $V_{SS}$			1.0	$\mu\text{A}$
		$V_{CC} = 5.0\text{V}$				6.0	$\mu\text{A}$
$I_{LI}$	Input Leakage Current $V_{CC} = 5.0\text{V}$	$V_{IN} = V_{CC}$ or $V_{SS}$			0.10	3.0	$\mu\text{A}$
$I_{LO}$	Output Leakage Current $V_{CC} = 5.0\text{V}$	$V_{OUT} = V_{CC}$ or $V_{SS}$			0.05	3.0	$\mu\text{A}$
$V_{IL}$	Input Low Level <sup>(1)</sup>			-0.6		$V_{CC} \times 0.3$	V
$V_{IH}$	Input High Level <sup>(1)</sup>			$V_{CC} \times 0.7$		$V_{CC} + 0.5$	V
$V_{OL1}$	Output Low Level	$V_{CC} = 1.7\text{V}$	$I_{OL} = 0.15\text{mA}$			0.2	V
$V_{OL2}$	Output Low Level	$V_{CC} = 3.0\text{V}$	$I_{OL} = 2.1\text{mA}$			0.4	V

Note: 1.  $V_{IL}$  min and  $V_{IH}$  max are reference only and are not tested.

## 5.3 AC Characteristics

**Table 5-3. AC Characteristics (Industrial Temperature)**

Applicable over recommended operating range from:  $T_{AI} = -40^{\circ}\text{C}$  to  $+85^{\circ}\text{C}$ ,  $V_{CC} = 1.7\text{V}$  to  $5.5\text{V}$ ,  $CL = 100\text{pF}$  (unless otherwise noted). Test conditions are listed in Note 2.

Symbol	Parameter	1.7V		2.5V, 5.0V		Units
		Min	Max	Min	Max	
$f_{SCL}$	Clock Frequency, SCL		400		1000	kHz
$t_{LOW}$	Clock Pulse Width Low	1300		400		ns
$t_{HIGH}$	Clock Pulse Width High	600		400		ns
$t_I$	Noise Suppression Time <sup>(1)</sup>		100		50	ns
$t_{AA}$	Clock Low to Data Out Valid	50	900	50	550	ns
$t_{BUF}$	Time the bus must be free before a new transmission can start <sup>(1)</sup>	1300		500		ns
$t_{HD.STA}$	Start Hold Time	600		250		ns
$t_{SU.STA}$	Start Set-up Time	600		250		ns
$t_{HD.DAT}$	Data In Hold Time	0		0		ns
$t_{SU.DAT}$	Data In Set-up Time	100		100		ns
$t_R$	Inputs Rise Time <sup>(1)</sup>		300		300	ns
$t_F$	Inputs Fall Time <sup>(1)</sup>		300		100	ns
$t_{SU.STO}$	Stop Set-up Time	600		250		ns
$t_{DH}$	Data Out Hold Time	50		50		ns
$t_{WR}$	Write Cycle Time		5		5	ms
Endurance <sup>(1)</sup>	25°C, Page Mode, 3.3V	1,000,000				Write Cycles

Notes: 1. This parameter is ensured by characterization and is not 100% tested.

2. AC measurement conditions:

- $R_L$  (connects to  $V_{CC}$ ): 1.3k $\Omega$  (2.5V, 5.5V), 10k $\Omega$  (1.7V)
- Input pulse voltages: 0.3 $V_{CC}$  to 0.7 $V_{CC}$
- Input rise and fall times:  $\leq 50\text{ns}$
- Input and output timing reference voltages: 0.5 x  $V_{CC}$

## 6. Device Operation

**Clock and Data Transitions:** The SDA pin is normally pulled high with an external device. Data on the SDA pin may change only during SCL low time periods. Data changes during SCL high periods will indicate a start or stop condition as defined below.

**Figure 6-1. Data Validity**



**Start Condition:** A high-to-low transition of SDA with SCL high is a start condition that must precede any other command.

**Stop Condition:** A low-to-high transition of SDA with SCL high is a stop condition. After a read sequence, the stop command will place the EEPROM in a standby power mode.

**Figure 6-2. Start and Stop Definition**

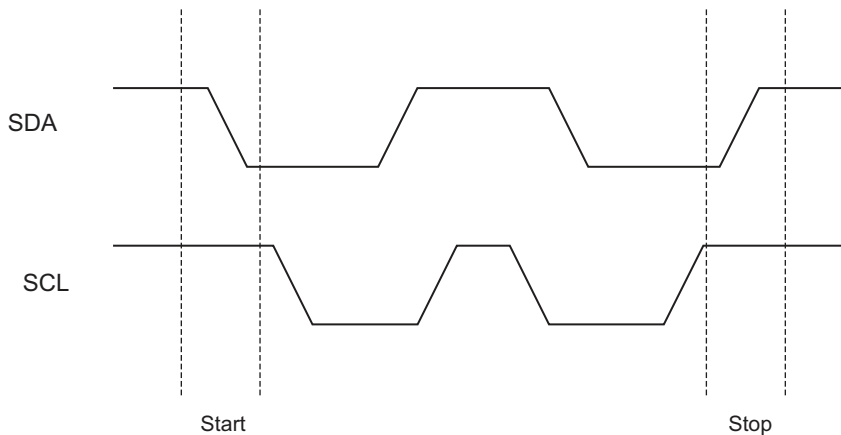

**Acknowledge:** All addresses and data words are serially transmitted to and from the EEPROM in 8-bit words. The EEPROM sends a zero during the ninth clock cycle to acknowledge that it has received each word.

**Figure 6-3. Output Acknowledge**

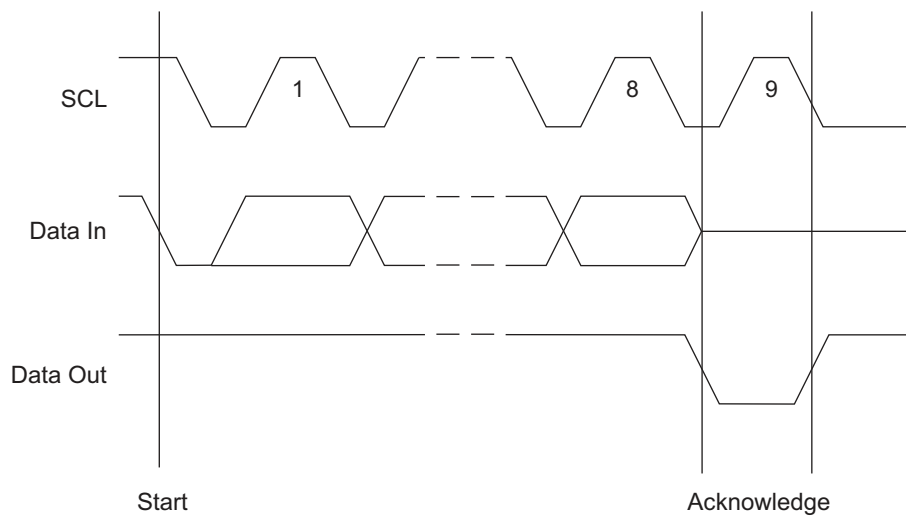

**Standby Mode:** AT24C128C features a low-power standby mode that is enabled upon power-up and after the receipt of the stop bit and the completion of any internal operations.

**Software Reset:** After an interruption in protocol, power loss or system reset, any 2-wire part can be protocol reset by following these steps:

1. Create a Start condition (if possible).
2. Clock nine cycles.
3. Create another Start condition followed by Stop condition as shown below.

The device should be ready for the next communication after above steps have been completed. In the event that the device is still non-responsive or remains active on the SDA bus, a power cycle must be used to reset the device.

**Figure 6-4. Software Reset**

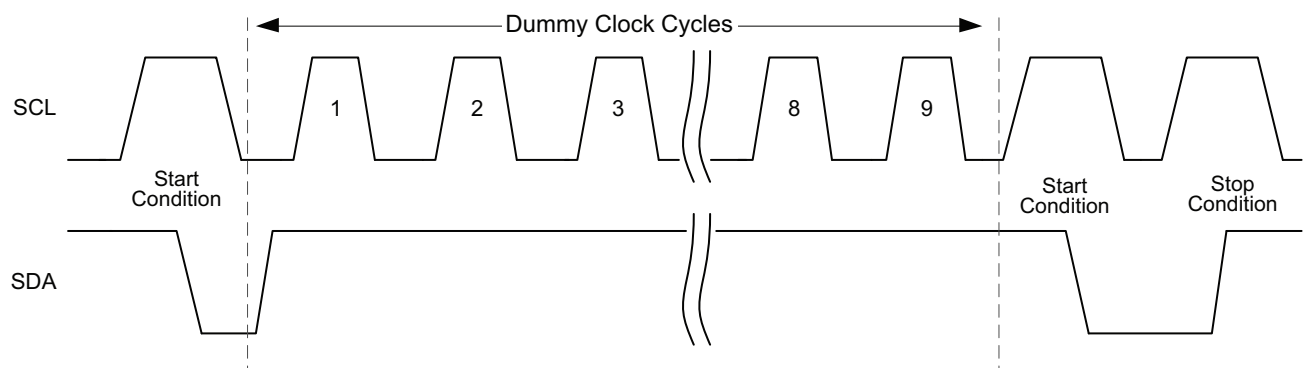

Figure 6-5. Bus Timing

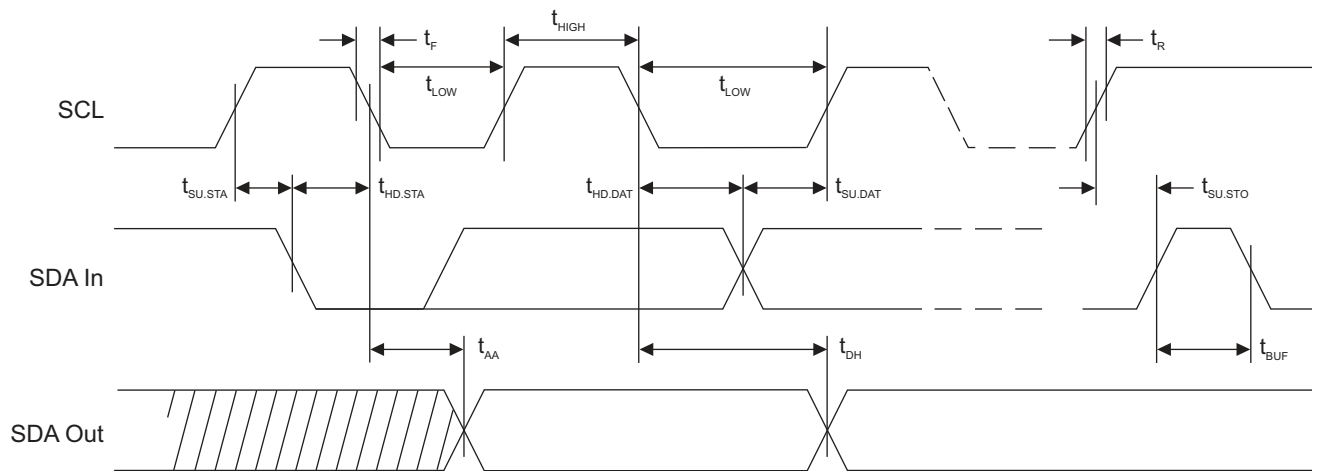
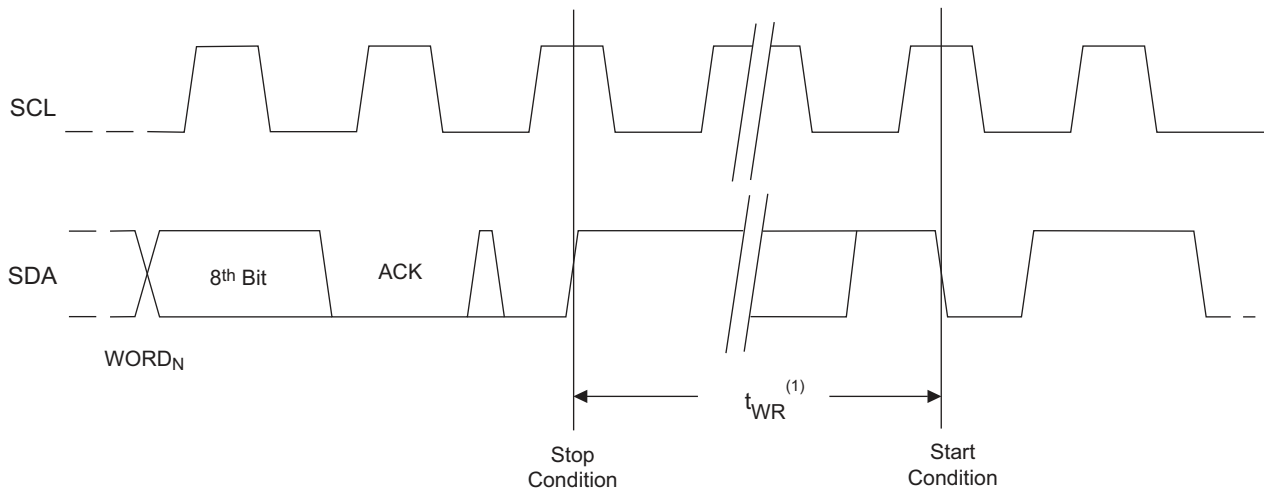

Figure 6-6. Write Cycle Timing



Note: 1. The write cycle time  $t_{WR}$  is the time from a valid stop condition of a write sequence to the end of the internal clear/write cycle.



## 7. Device Addressing

The 128K EEPROM requires an 8-bit device address word following a start condition to enable the chip for a read or write operation. The device address word consists of a mandatory one, zero sequence for the first four most significant bits as shown. This is common to all 2-wire EEPROM devices.

**Table 7-1. Device Address Byte**

Package	Device Type Identifier				Hardware Slave Address Bits			Read/ Write
	Bit 7	Bit 6	Bit 5	Bit 4	Bit 3	Bit 2	Bit 1	Bit 0
SOIC, TSSOP, UDFN, XDFN, VFBGA	1	0	1	0	A <sub>2</sub>	A <sub>1</sub>	A <sub>0</sub>	R/ $\overline{W}$
WLCSP	1	0	1	0	0	0	1	R/ $\overline{W}$

The next three bits are the A<sub>2</sub>, A<sub>1</sub>, and A<sub>0</sub> device address bits to allow as many as eight devices on the same bus. These bits must compare to their corresponding hard wired input pins. The A<sub>2</sub>, A<sub>1</sub>, and A<sub>0</sub> pins use an internal proprietary circuit that biases them to a logic low condition if the pins are allowed to float.

When using the WLCSP package, the A<sub>2</sub>, A<sub>1</sub>, and A<sub>0</sub> signals are not accessible. The A<sub>2</sub> and A<sub>1</sub> pins are left floating, and the previously mentioned automatic pull-down circuit will set these signals to a Logic 0 state. The A<sub>0</sub> signal is internally connected to V<sub>CC</sub>. As a result, to properly communicate with the device in the WLCSP package, the A<sub>2</sub> and A<sub>1</sub> software bits must always be set to a Logic 0, and the A<sub>0</sub> software bit must be set to Logic 1 for any operation. This requirement has been shown in [Table 7-1](#).

The eighth bit of the device address is the read/write operation select bit. A read operation is initiated if this bit is high, and a write operation is initiated if this bit is low.

Upon a compare of the device address, the EEPROM will output a zero. If a compare is not made, the device will return to a standby state.

**Data Security:** AT24C128C has a hardware data protection scheme that allows the user to write protect the whole memory when the WP pin is at V<sub>CC</sub>.

## 8. Write Operations

**Byte Write:** A write operation requires two 8-bit data word addresses following the device address word and acknowledgment. Upon receipt of this address, the EEPROM will again respond with a zero, and then clock in the first 8-bit data word. Following receipt of the 8-bit data word, the EEPROM will output a zero. The addressing device, such as a microcontroller, must then terminate the write sequence with a stop condition. At this time, the EEPROM enters an internally-timed write cycle,  $t_{WR}$ , to the nonvolatile memory. All inputs are disabled during this write cycle and the EEPROM will not respond until the write is complete.

**Figure 8-1. Byte Write**

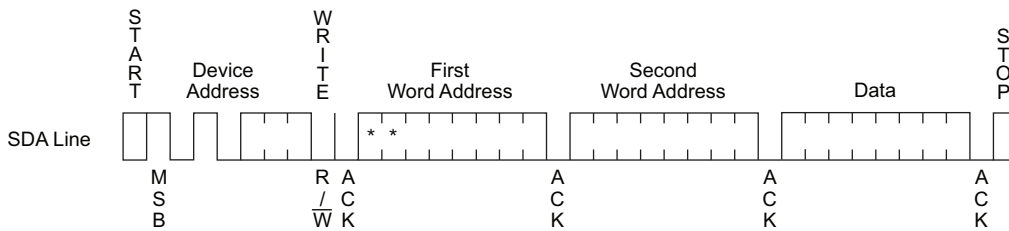

Note: \* = Don't care bit

**Page Write:** The 128K EEPROM is capable of 64-byte page writes.

A page write is initiated the same way as a byte write, but the microcontroller does not send a stop condition after the first data word is clocked in. Instead, after the EEPROM acknowledges receipt of the first data word, the microcontroller can transmit up to 63 more data words. The EEPROM will respond with a zero after each data word received. The microcontroller must terminate the page write sequence with a stop condition.

**Figure 8-2. Page Write**

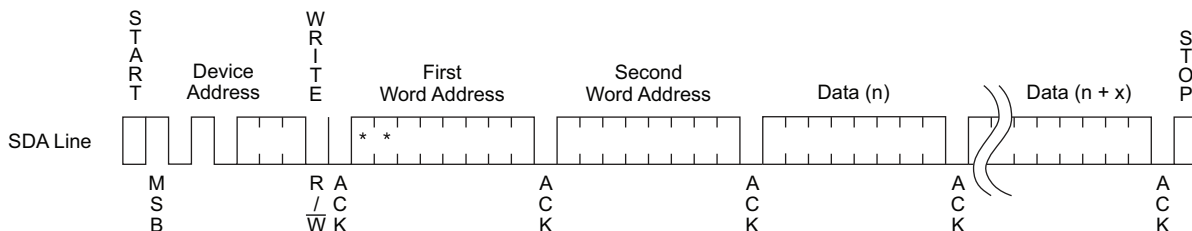

Note: \* = Don't care bit

The data word address lower six bits are internally incremented following the receipt of each data word. The higher data word address bits are not incremented, retaining the memory page row location. When the word address, internally generated, reaches the page boundary, the following byte is placed at the beginning of the same page. If more than 64 data words are transmitted to the EEPROM, the data word address will roll-over and the previous data will be overwritten. The address roll-over during write is from the last byte of the current page to the first byte of the same page.

**Acknowledge Polling:** Once the internally-timed write cycle has started and the EEPROM inputs are disabled, acknowledge polling can be initiated. This involves sending a start condition followed by the device address word. The read/write bit is representative of the operation desired. Only if the internal write cycle has completed will the EEPROM respond with a zero, allowing the read or write sequence to continue.

## 9. Read Operations

Read operations are initiated the same way as write operations with the exception that the read/write select bit in the device address word is set to one. There are three read operations:

- Current Address Read
- Random Address Read
- Sequential Read

**Current Address Read:** The internal data word address counter maintains the last address accessed during the last read or write operation, incremented by one. This address stays valid between operations as long as the chip power is maintained. The address roll-over during read is from the last byte of the last memory page, to the first byte of the first page.

Once the device address with the read/write select bit set to one is clocked in and acknowledged by the EEPROM, the current address data word is serially clocked out. The microcontroller does not respond with an input zero but does generate a following stop condition.

**Figure 9-1. Current Address Read**

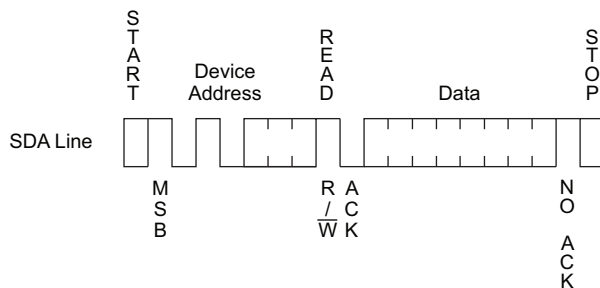

**Random Read:** A Random Read requires a dummy byte write sequence to load in the data word address. Once the device address word and data word address are clocked in and acknowledged by the EEPROM, the microcontroller must generate another start condition. The microcontroller now initiates a Current Address Read by sending a device address with the read/write select bit high. The EEPROM acknowledges the device address and serially clocks out the data word. The microcontroller does not respond with a zero but does generate a following stop condition.

**Figure 9-2. Random Read**

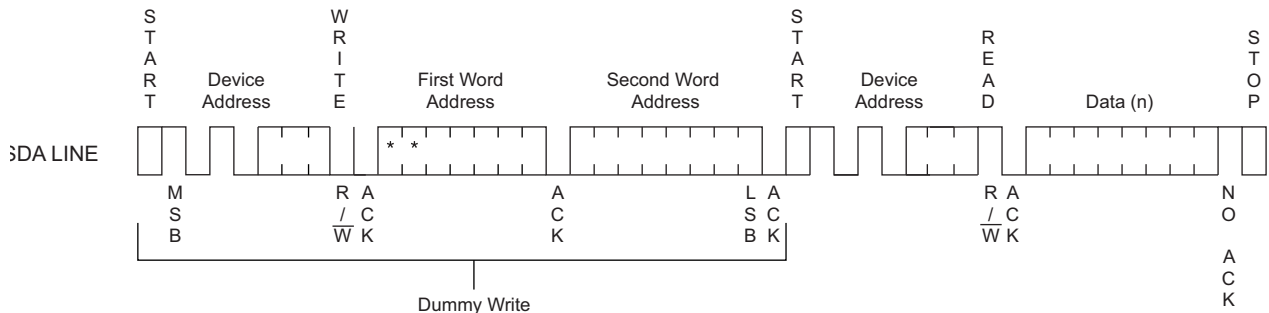

Note: \* = Don't care bit

**Sequential Read:** Sequential Reads are initiated by either a Current Address Read or a Random Address Read. After the microcontroller receives a data word, it responds with an acknowledge. As long as the EEPROM receives an acknowledge, it will continue to increment the data word address and serially clock out sequential data words. When the memory address maximum address is reached, the data word address will roll-over and the Sequential Read will continue from the beginning of the array. The Sequential Read operation is terminated when the microcontroller does not respond with a zero but does generate a following stop condition.

**Figure 9-3. Sequential Read**

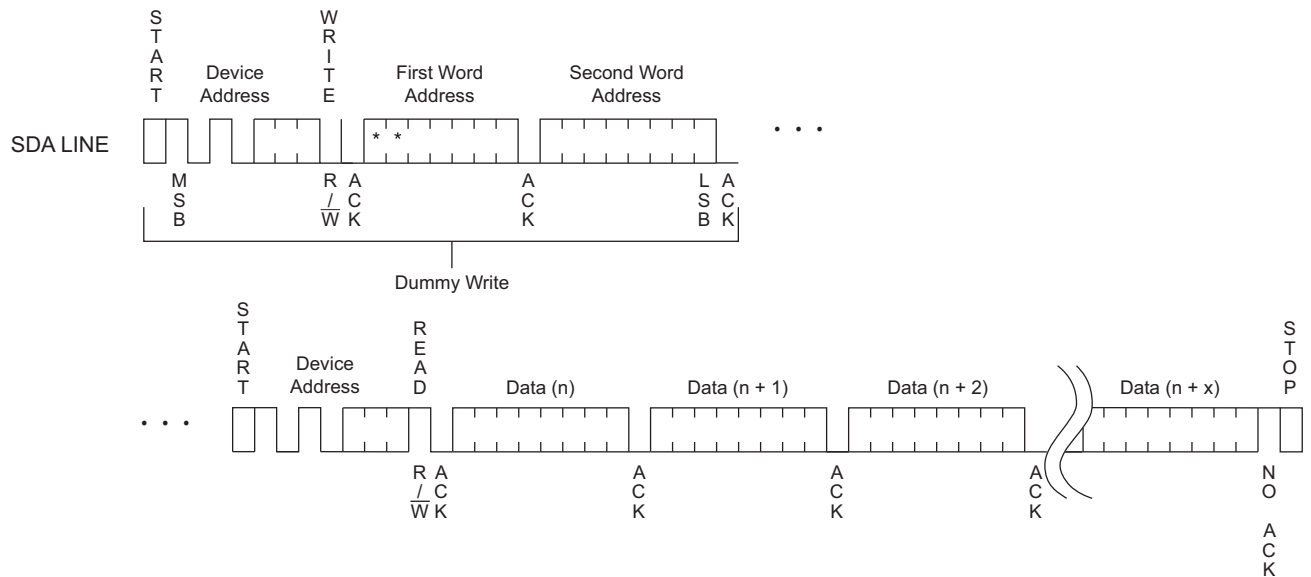

Note: \* = Don't care bit

# 10. Ordering Information

## 10.1 Ordering Code Detail

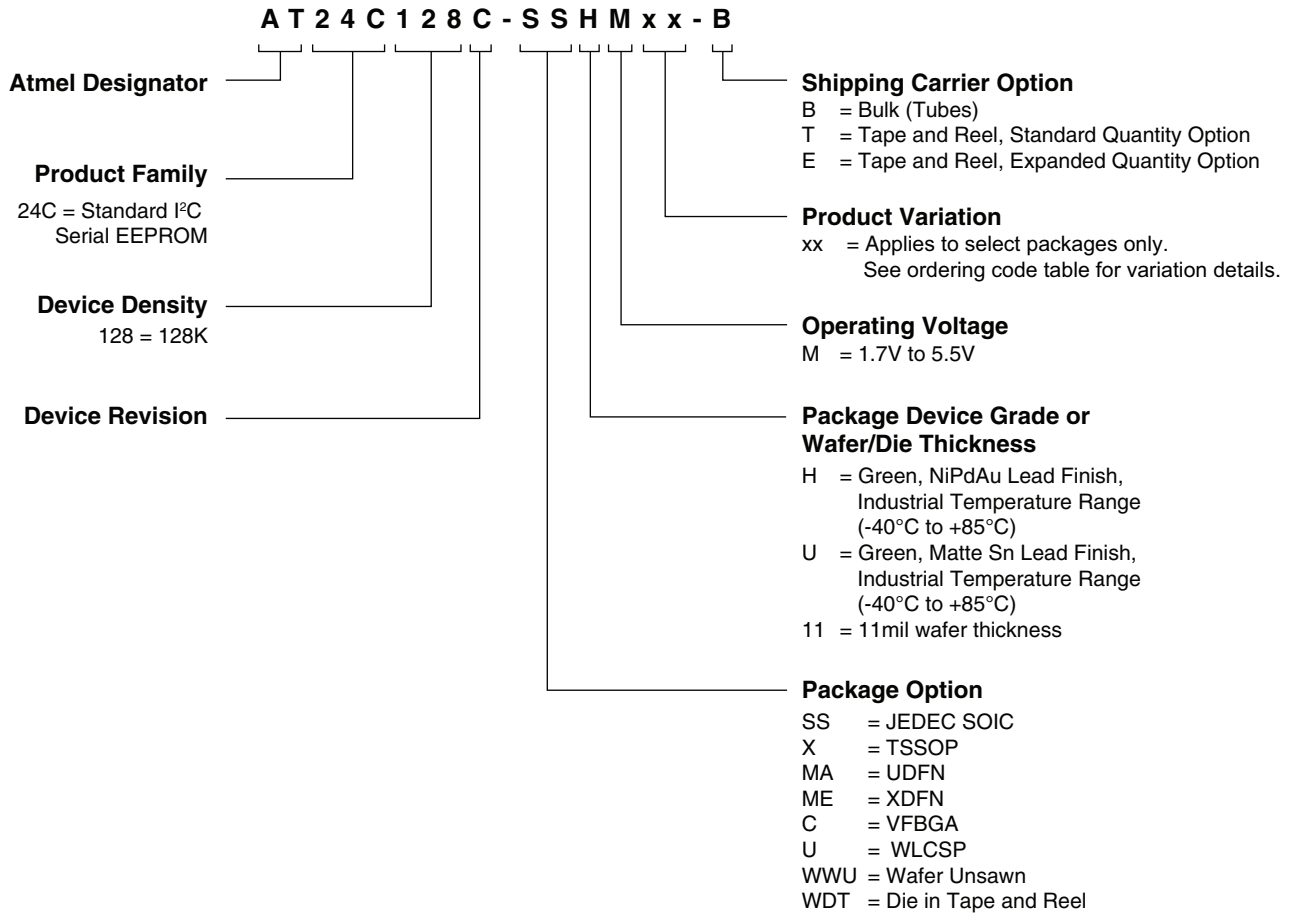

## 10.2 Ordering Code Information

Atmel Ordering Code	Lead Finish	Package	Delivery Information		Operating Range	
			Form	Quantity		
AT24C128C-SSHM-B	NiPdAu (Lead-free/Halogen-free)	8S1	Bulk (Tubes)	100 per Tube	Industrial Temperature (-40°C to 85°C)	
AT24C128C-SSHM-T			Tape and Reel	4,000 per Reel		
AT24C128C-XHM-B		8X	Bulk (Tubes)	100 per Tube		
AT24C128C-XHM-T			Tape and Reel	5,000 per Reel		
AT24C128C-MAHM-T		8MA2	Tape and Reel	5,000 per Reel		
AT24C128C-MAHM-E				15,000 per Reel		
AT24C128C-MAHMML-T			5,000 per Reel			
AT24C128C-MEHM-T			8ME1	Tape and Reel		5,000 per Reel
AT24C128C-CUM-T		SnAgCu Ball (Lead-free/Halogen-free)	8U2-1	Tape and Reel		5,000 per Reel
AT24C128C-UUM0B-T <sup>(1)</sup>			4U-9	Tape and Reel		5,000 per Reel
AT24C128C-UUMML-T <sup>(1)</sup>						
AT24C128C-WWU11M <sup>(2)</sup>	N/A	Wafer Sale	Note 2			

Notes: 1. WLCSP Package:

- This device includes a backside coating to increase product robustness.
- **CAUTION:** Exposure to ultraviolet (UV) light can degrade the data stored in the EEPROM cells. Therefore, customers who use a WLCSP product must ensure that exposure to ultraviolet light does *not* occur.

2. Contact Atmel Sales for Wafer sales.

Package Type	
8S1	8-lead, 0.150" wide, Plastic Gull Wing Small Outline (JEDEC SOIC)
8X	8-lead, 4.40mm body, Plastic Thin Shrink Small Outline Package (TSSOP)
8MA2	8-pad, 2.00mm x 3.00mm body, 0.50mm pitch, Dual No Lead (UDFN)
8ME1	8-pad, 1.80mm x 2.20mm body, Extra Thin DFN (XDFN)
8U2-1	8-ball, Die Ball Grid Array (VFBGA)
4U-9	4-ball, 2 x 2 Grid Array, 0.40mm minimum pitch, Wafer Level Chip Scale Package (WLCSP)

# 11. Part Markings

## AT24C128C: Package Marking Information

<p>8-lead SOIC</p>	<p>8-lead TSSOP</p>	<p>8-lead UDFN</p> <p>2.0 x 3.0 mm Body</p>
<p>8-ball VFBGA</p> <p>2.35 x 3.73 mm Body</p>	<p>8-lead XDFN</p> <p>1.8 x 2.2 mm Body</p>	<p>4-ball WLCSP</p>

Note 1: ● designates pin 1  
 Note 2: Package drawings are not to scale

Catalog Number Truncation			
AT24C128C		Truncation Code ###: 2DC	
Date Codes			Voltages
Y = Year	M = Month	WW = Work Week of Assembly	% = Minimum Voltage
5: 2015    9: 2019	A: January	02: Week 2	M: 1.7V min
6: 2016    0: 2020	B: February	04: Week 4	
7: 2017    1: 2021	...	...	
8: 2018    2: 2022	L: December	52: Week 52	
Country of Assembly		Lot Number	Grade/Lead Finish Material
@ = Country of Assembly		AAA...A = Atmel Wafer Lot Number	U: Industrial/Matte Tin H: Industrial/NiPdAu
Trace Code			Atmel Truncation
XX = Trace Code (Atmel Lot Numbers Correspond to Code) Example: AA, AB.... YZ, ZZ			AT: Atmel ATM: Atmel ATML: Atmel

1/5/15

<p>Package Mark Contact: DL-CSO-Assy_eng@atmel.com</p>	<p><b>TITLE</b></p> <p>24C128CSM, AT24C128C Standard Package Marking Information</p>	<p><b>DRAWING NO.</b></p> <p>24C128CSM</p>	<p><b>REV.</b></p> <p>D</p>
	<p>Atmel</p>		

## 12. Packaging Information

### 12.1 8S1 — 8-lead JEDEC SOIC





## 12.2 8X — 8-lead TSSOP

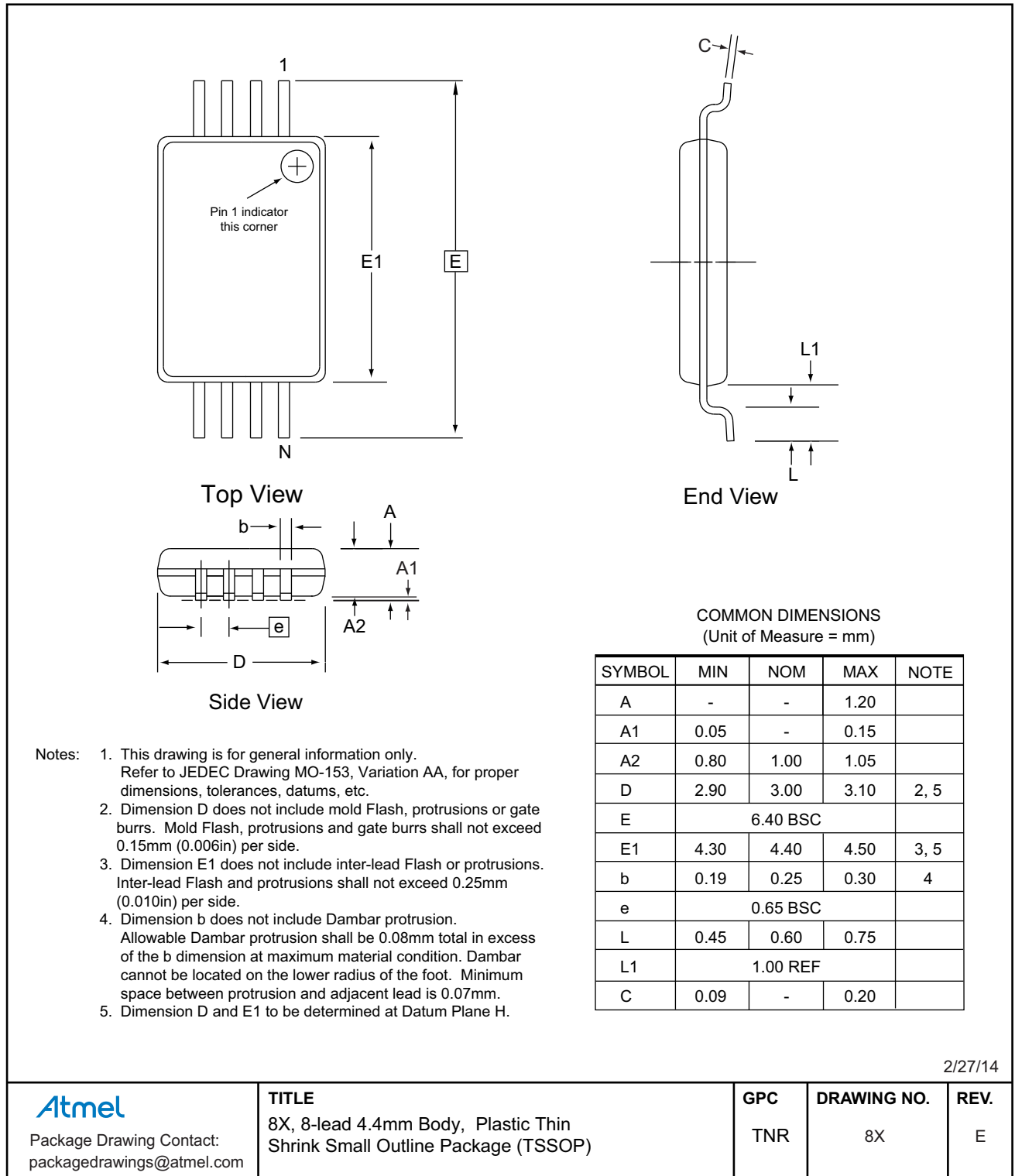

## 12.3 8MA2 — 8-pad UDFN

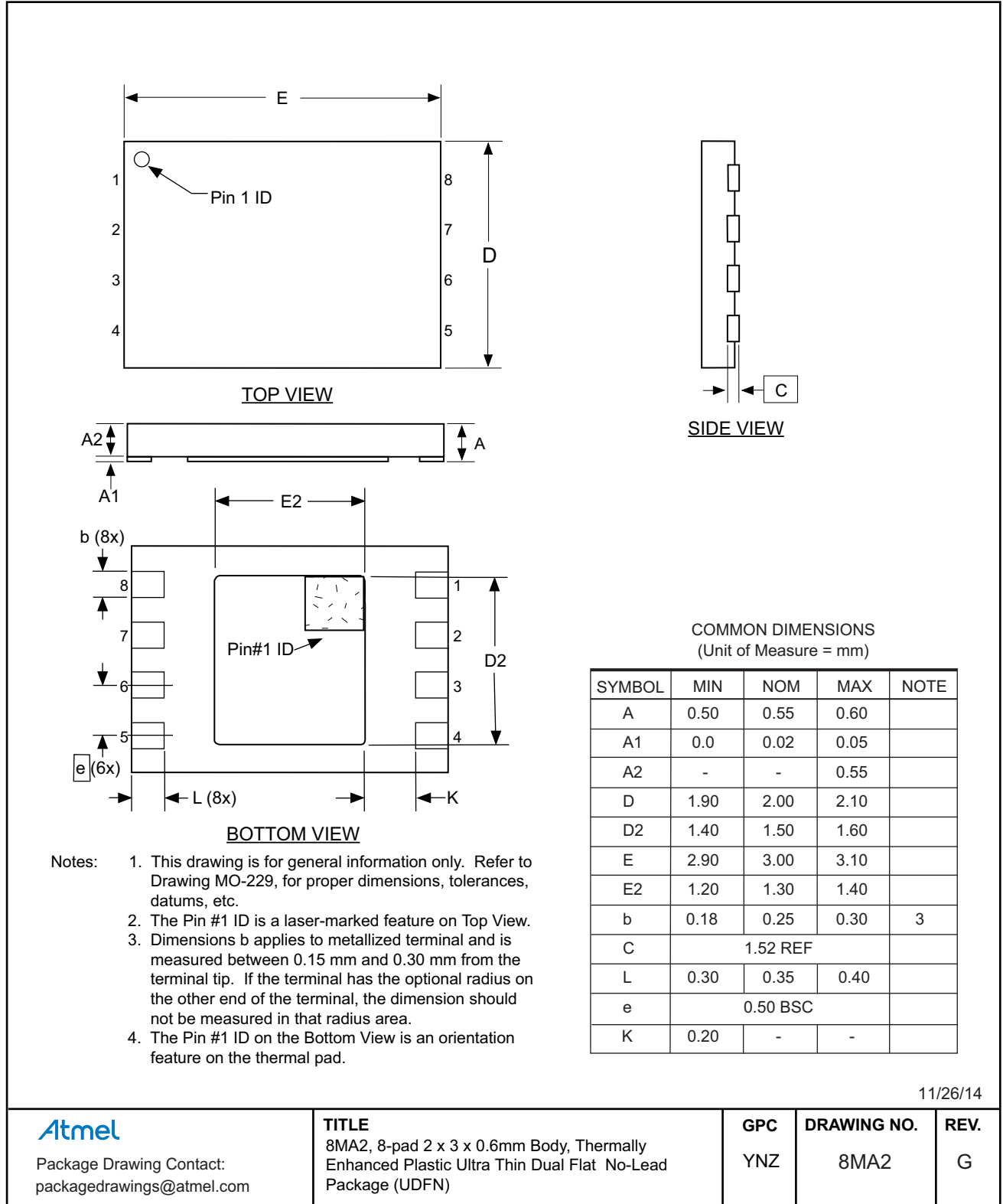

11/26/14

**Atmel**

Package Drawing Contact:  
packagedrawings@atmel.com

**TITLE**

8MA2, 8-pad 2 x 3 x 0.6mm Body, Thermally Enhanced Plastic Ultra Thin Dual Flat No-Lead Package (UDFN)

**GPC**

YNZ

**DRAWING NO.**

8MA2

**REV.**

G

## 12.4 8ME1 — 8-pad XDFN



## 12.5 8U2-1 — 8-ball VFBGA

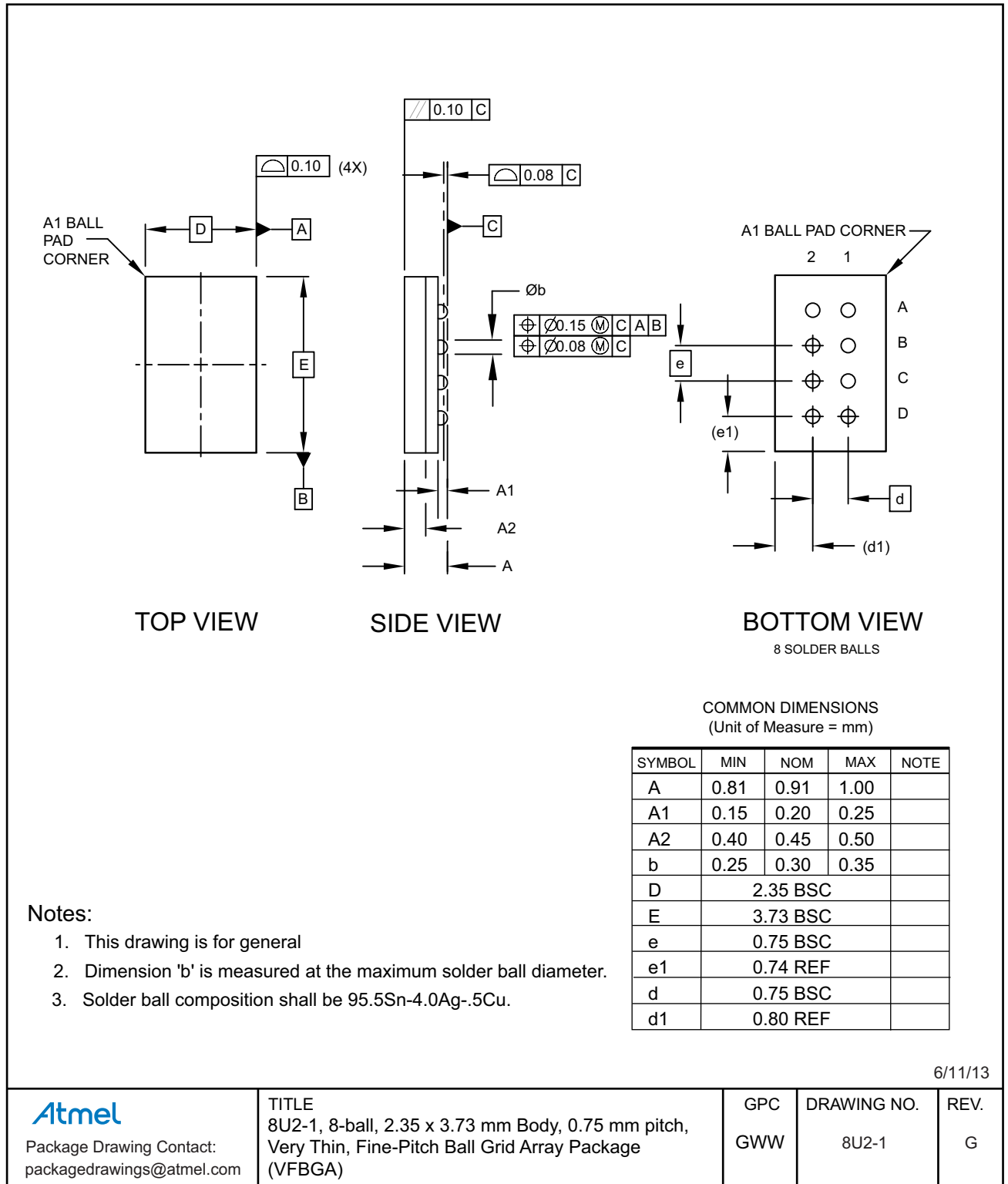

## 12.6 4U-9 — 4-ball WLCSP

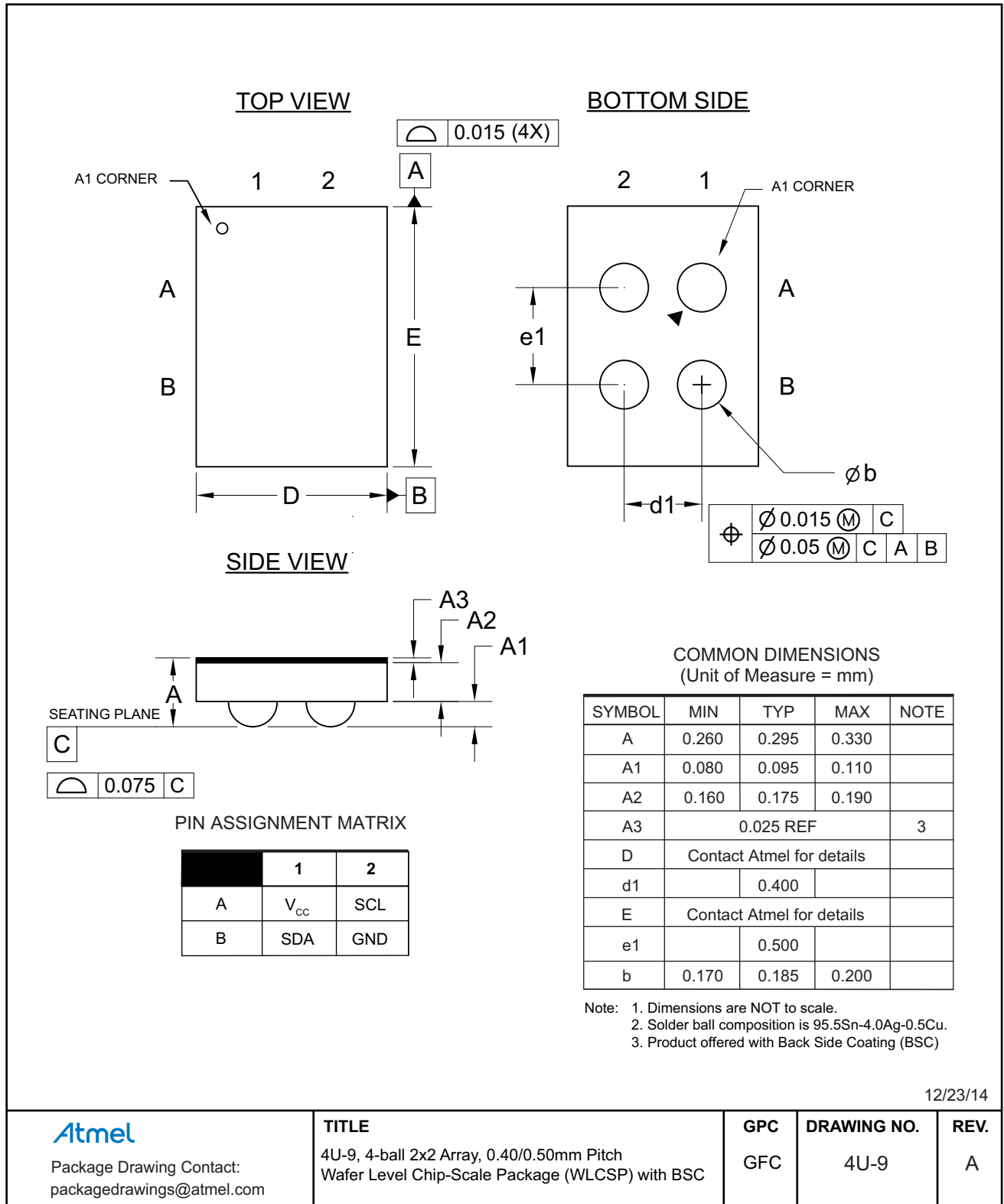

## 13. Revision History

Doc. Rev.	Date	Comments
8735D	08/2015	Added the AT24C128C-MAHMML-T and AT24C128C-UUMML-T package options. Updated the 8S1 package outline drawing. Corrected reference of the 8U-9 to reflect the 4U-9 package option.
8734C	01/2015	Added the UDFN Expanded Quantity Option and the WLCSP package option. Updated the 8MA2 package outline drawing and the ordering information section.
8734B	09/2012	Updated UDFN package drawing and template and Atmel logo.
8734A	04/2011	Initial document release.





Компания «ЭлектроПласт» предлагает заключение долгосрочных отношений при поставках импортных электронных компонентов на взаимовыгодных условиях!

Наши преимущества:

- Оперативные поставки широкого спектра электронных компонентов отечественного и импортного производства напрямую от производителей и с крупнейших мировых складов;
- Поставка более 17-ти миллионов наименований электронных компонентов;
- Поставка сложных, дефицитных, либо снятых с производства позиций;
- Оперативные сроки поставки под заказ (от 5 рабочих дней);
- Экспресс доставка в любую точку России;
- Техническая поддержка проекта, помощь в подборе аналогов, поставка прототипов;
- Система менеджмента качества сертифицирована по Международному стандарту ISO 9001;
- Лицензия ФСБ на осуществление работ с использованием сведений, составляющих государственную тайну;
- Поставка специализированных компонентов (Xilinx, Altera, Analog Devices, Intersil, Interpoint, Microsemi, Aeroflex, Peregrine, Syfer, Eurofarad, Texas Instrument, Miteq, Cobham, E2V, MA-COM, Hittite, Mini-Circuits, General Dynamics и др.);

Помимо этого, одним из направлений компании «ЭлектроПласт» является направление «Источники питания». Мы предлагаем Вам помощь Конструкторского отдела:

- Подбор оптимального решения, техническое обоснование при выборе компонента;
- Подбор аналогов;
- Консультации по применению компонента;
- Поставка образцов и прототипов;
- Техническая поддержка проекта;
- Защита от снятия компонента с производства.



#### Как с нами связаться

**Телефон:** 8 (812) 309 58 32 (многоканальный)

**Факс:** 8 (812) 320-02-42

**Электронная почта:** [org@eplast1.ru](mailto:org@eplast1.ru)

**Адрес:** 198099, г. Санкт-Петербург, ул. Калинина, дом 2, корпус 4, литера А.