

Tous droits strictement réservés. Reproduction ou communication à des tiers interdite sous quelque forme que ce soit sans autorisation écrite du propriétaire. Propriété de c.FCI. Droits de reproduction FCI.

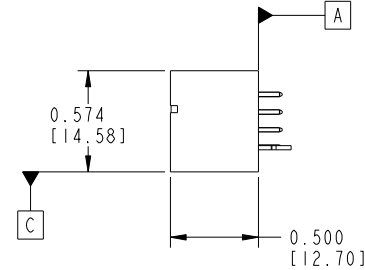

All rights strictly reserved. Reproduction or issue to third parties in any form whatever is not permitted without written authority from the proprietor. Property of FCI. Copyright FCI.

PRODUCT NUMBER  
51703-ABB00000EF\_\_  
Note: ①  
SEE NOTE 1

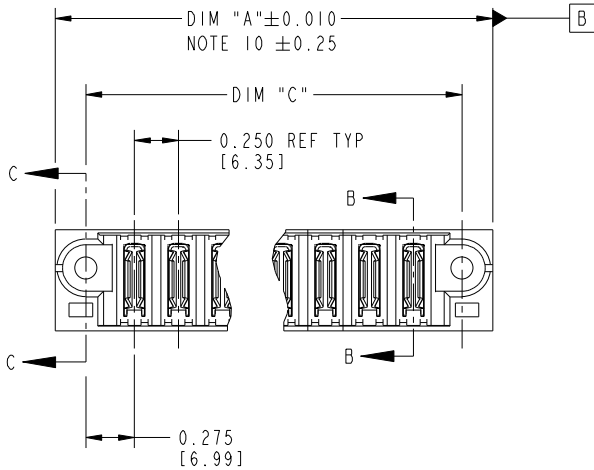
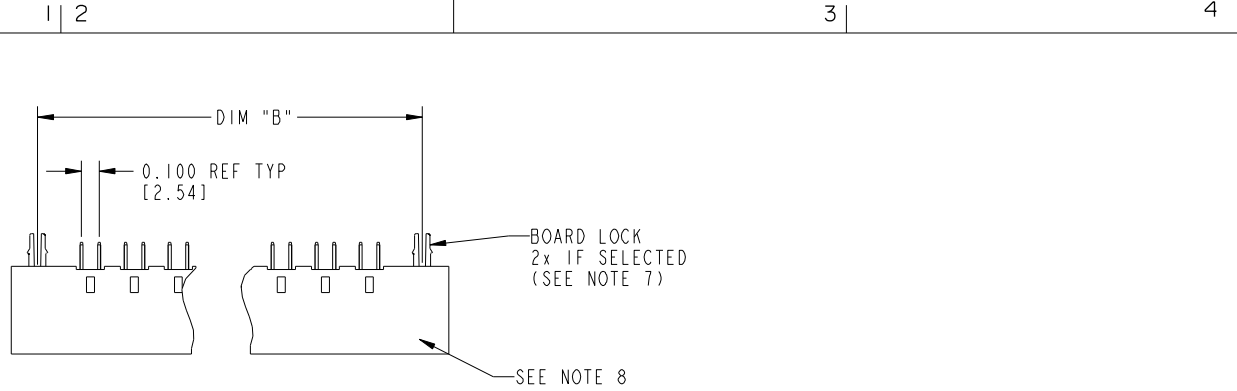

mat'l code				SEE NOTE 2		tolerances unless otherwise specified		CUSTOMER		 www.fciconnect.com		
ltr	ecn no.	dr	date	linear	.XX±.01/.X±.3		COPY		title VERTICAL HEADER w/GUIDE PIN POWER			
A	V11839	JRW	07/09/01		.XXX±.005/.XX±.13		projection					
B	V12500	DAI	10-16-01	angles	.XXX±.0020/.X±.051		 INCH/MM		product family PWRBLADE code 213			
C	V12513	DAI	11-07-01		0°±2°		scale 1:1		size dwg no 51703 sheet 1 of 3			
D	V21104	TAB	09-24-02	dr	JRW	10-16-01	A		cage code 22526			
E	DG05-0132	SJ	06/02/05	enr	J.ALLISON	10-16-01						
F	DG05-0193	SJ	06/24/05	chr	J.ALLISON	10-16-01						
G	DG08-0239	JC	09/11/08	appd	J.ALLISON	10-16-01						
sheet index		revision sheet		G	G	G						
		I 2 3										

Pro/E

cage code 22526



Tous droits strictement réservés. Reproduction ou communication à des tiers interdite sous quelque forme que ce soit sans autorisation écrite du propriétaire. Propriété de c FCI. Droits de reproduction FCI.

All rights strictly reserved. Reproduction or issue to third parties in any form whatever is not permitted without written authority from the proprietor. Property of FCI. Copyright FCI.

PRODUCT NUMBER
51703-ABB00000EF__ Note: ①
SEE NOTE 1

DIM	LENGTH FORMULAS (SEE NOTE 9)
DIM "A"	.250 [6.35] x BB + .650 [16.51] (NOTE 9)
DIM "B"	.250 [6.35] x BB + .350 [8.81]
DIM "C"	.250 [6.35] x BB + .300 [7.62]
DIM "F"	.250 [6.35] x BB + .680 [17.27]

CONNECTOR NOTES:

- ①. PRODUCT NUMBER CODE:  
51703 - A BB 000 00 E F LF
- NO THIS SUFFIX: 100u"/2.54um SnPb ON PCB INTERFACE
  - ADD THIS SUFFIX: 78u"/2.00um Sn ON PCB INTERFACE 
  - RETENTION TO PCB (NOTE 7)
  - TAIL OPTIONS (NOTE 6)
  - ALWAYS '00' (ZERO,ZERO)
  - ALWAYS '000' (ZERO,ZERO,ZERO) (NOTE 5)
  - NUMBER OF POWER CONTACTS (NOTE 4)
  - PLATING (NOTE 3)
  - BASE NUMBER
- ②. HOUSING MATERIAL: UL94 V-0 GLASS FILLED HIGH TEMP THERMO PLASTIC  
POWER CONTACT MATERIAL: COPPER ALLOY
-  ③. PLATING OPTION:  
I = SEE PRINT I0064I83 FOR PLATING SPEC OF 51703-1BB00000EF; 51703-1BB00000EFLF
- ④. POWER CONTACTS, 01 TO 20 AVAILABLE.  
MAXIMUM OF 20 POWER CONTACTS PER CONNECTOR
- ⑤. THIS PART IS NOT AVAILABLE WITH SIGNAL CONTACTS.
- ⑥. TAIL OPTIONS:  
A = 0.135 +0.015/-0.010 [3.43 +0.37/-0.25] SOLDER TO BOARD  
B = 0.165 +0.015/-0.010 [4.19 +0.37/-0.25] SOLDER TO BOARD  
C = 0.165 +0.015/-0.010 [4.19 +0.37/-0.25] PRESS FIT

- ⑦. RETENTION TO PCB OPTIONS:  
A = BOARD LOCK (REQUIRES Ø0.098 +0.002/-0.001 [2.49 +0.05/-0.03] THRU HOLE IN PCB).  
(NOT AVAILABLE WITH PRESS-FIT)  
C = NO RETENTION FEATURE
- ⑧. MANUFACTURE'S NAME, P/N, AND DATE CODE TO APPEAR ON THIS SURFACE.
- ⑨. THE MAXIMUM OVERALL LENGTH (DIM A) OF A PART IS 8.00 [203.2]
10. PRODUCT SPECIFICATION GS-12-149
11. DIMENSIONS AND TOLERANCES ARE IN ACCORDANCE WITH ASME Y14.5M, 1994 UNLESS OTHERWISE SPECIFIED.
- PCB NOTES:
12. ALL DIMENSIONS ARE BASIC UNLESS OTHERWISE SPECIFIED.
13. ALL THROUGH HOLES ARE LOCATED WITH A TRUE POSITION OF 0.004 [0.10]
14. ALL HOLE DIAMETERS ARE FINISHED HOLE SIZE.
15. Ø0.098 [2.49] THROUGH HOLES ARE UNPLATED
16. Ø0.0453 ±0.0010 [1.151 ±0.025] DRILLED HOLES PLATED WITH: 0.0003 [0.008] MIN SnPb OVER 0.001 [0.03] TO 0.003 [0.08] Cu PLATING TO ACHIEVE A Ø0.040±0.003 [1.02±0.07] HOLE.
17. FOR PRESSFIT APPLICATION USE C1 CAM TOOL 430169-XXX.
18. A  SYMBOL WILL BE NEXT TO ANY DIMENSION, VIEW, OR NOTE WHICH HAS BEEN MODIFIED WITH THE CURRENT DRAWING REVISION.

mat'l code SEE NOTE 2				tolerances unless otherwise specified		CUSTOMER			
ltr	ecn no.	dr	date	linear	.XX±.01/.X±.3	COPY		www.fciconnect.com	
G				projection	.XXX±.005/.XX±.13	title		VERTICAL HEADER w/GUIDE PIN POWER	
				angles	.XXX±.0020/.X±.051	product family		PWRBLADE	
				dr	0°±2°	size		213	
				enrg	JRW 10-16-01	scale		3:2	
				enrg	J.ALLISON 10-16-01	product family		PWRBLADE	
				chr	J.ALLISON 10-16-01	size		51703	
				appd	J.ALLISON 10-16-01	sheet		2 of 3	
sheet index	revision sheet					cage code		22526	

Tous droits strictement réservés. Reproduction ou communication à des tiers interdite sous quelque forme que ce soit sans autorisation écrite du propriétaire. Propriété de c.FCI. Droits de reproduction FCI.



All rights strictly reserved. Reproduction or issue to third parties in any form whatever is not permitted without written authority from the proprietor. Property of FCI. Copyright FCI.

PRODUCT NUMBER
51703-ABB00000EF_--
Note: ①
SEE NOTE 1

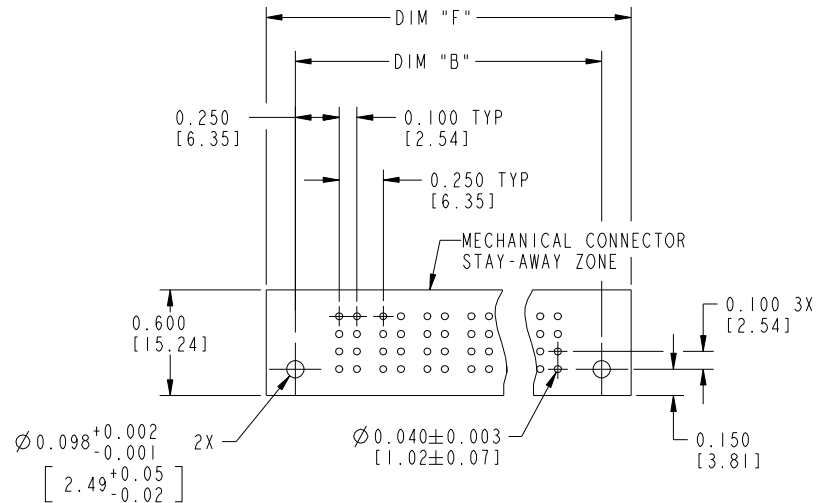
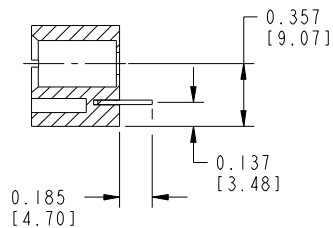
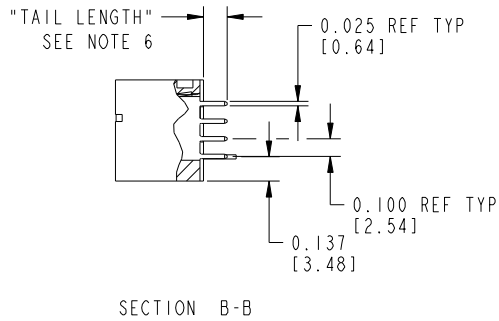

mat'l code				SEE NOTE 2		tolerances unless otherwise specified		CUSTOMER		 www.fciconnect.com	
ltr	ecn no.	dr	date	linear	.XX±.01/.X±.3		COPY		title VERTICAL HEADER w/GUIDE PIN POWER		
6					.XXX±.005/.XX±.13		projection				
					angles	.XXX±.0020/.X±.051		 INCH/MM		product family PWRBLADE code 213	
				dr		JRW	10-16-01	scale		size dwg no 51703 sheet 3 of 3	
				enr		J.ALLISON	10-16-01	1:1		A	
				chr	J.ALLISON	10-16-01					
				appd	J.ALLISON	10-16-01					
sheet index	revision sheet										cage code 22526

Pro/E

cage code 22526



Компания «ЭлектроПласт» предлагает заключение долгосрочных отношений при поставках импортных электронных компонентов на взаимовыгодных условиях!

Наши преимущества:

- Оперативные поставки широкого спектра электронных компонентов отечественного и импортного производства напрямую от производителей и с крупнейших мировых складов;
- Поставка более 17-ти миллионов наименований электронных компонентов;
- Поставка сложных, дефицитных, либо снятых с производства позиций;
- Оперативные сроки поставки под заказ (от 5 рабочих дней);
- Экспресс доставка в любую точку России;
- Техническая поддержка проекта, помощь в подборе аналогов, поставка прототипов;
- Система менеджмента качества сертифицирована по Международному стандарту ISO 9001;
- Лицензия ФСБ на осуществление работ с использованием сведений, составляющих государственную тайну;
- Поставка специализированных компонентов (Xilinx, Altera, Analog Devices, Intersil, Interpoint, Microsemi, Aeroflex, Peregrine, Syfer, Eurofarad, Texas Instrument, Miteq, Cobham, E2V, MA-COM, Hittite, Mini-Circuits, General Dynamics и др.);

Помимо этого, одним из направлений компании «ЭлектроПласт» является направление «Источники питания». Мы предлагаем Вам помощь Конструкторского отдела:

- Подбор оптимального решения, техническое обоснование при выборе компонента;
- Подбор аналогов;
- Консультации по применению компонента;
- Поставка образцов и прототипов;
- Техническая поддержка проекта;
- Защита от снятия компонента с производства.



#### Как с нами связаться

**Телефон:** 8 (812) 309 58 32 (многоканальный)

**Факс:** 8 (812) 320-02-42

**Электронная почта:** [org@eplast1.ru](mailto:org@eplast1.ru)

**Адрес:** 198099, г. Санкт-Петербург, ул. Калинина, дом 2, корпус 4, литера А.