



May. 2015 Ver.1.1
TDK Corporation

Multilayer Balun

For LTE

HHM Series

1608 TYPE

P/N: **HHM17168B1**

HHM17168B1

SHAPES AND DIMENSIONS

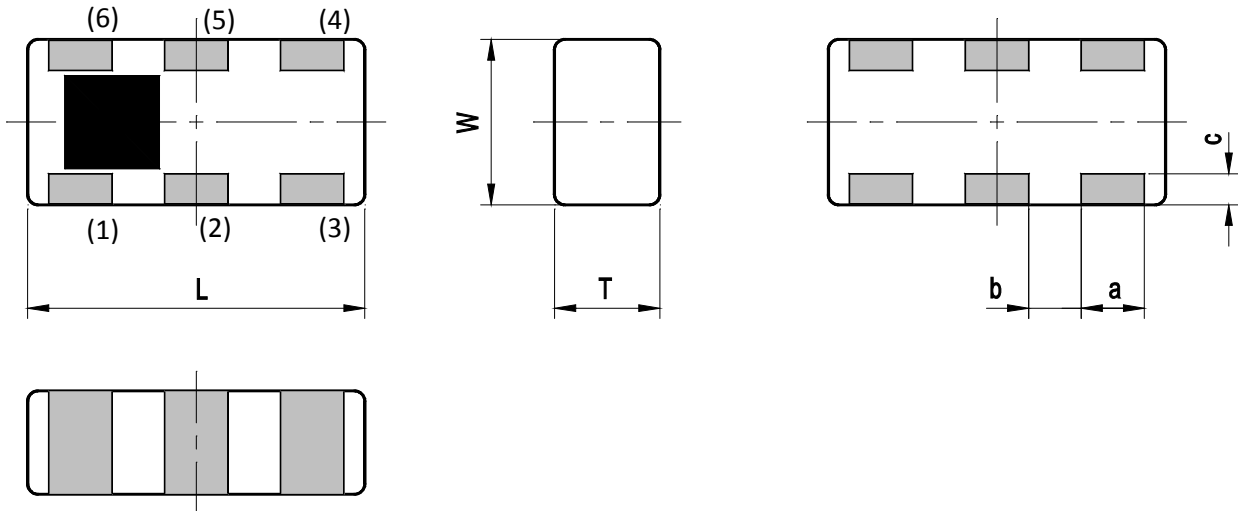

Dimensions (mm)

L	W	T	a	b	c
1.60	0.80	0.60	0.30	0.25	0.15
+/-0.10	+/-0.10	+/-0.10	+/-0.10	+/-0.10	+/-0.10

Terminal functions

(1)	Unbalanced Port
(2)	DC feed + RF GND or GND
(3)	Balanced Port
(4)	Balanced Port
(5)	GND

(6)	N.C.
-----	------

Note:

These samples are marked with trial sample identification.

In mass production, this sample marking will be changed to show in the TDK full specification.

TEMPERATURE RANGE

Operating temperature	Storage temperature
-40 to +85 °C	-40 to +85 °C

HHM17168B1

■ ELECTRICAL CHARACTERISTICS

(Measurement)

Parameter	Frequency (MHz)	TDK Spec		
		Min.	Typ.	Max.
Unbalanced Port Characteristic Impedance		50		
Balanced Port Characteristic Impedance		30.5-j55.2		
Return Loss at Unbalanced Port (dB)	3400 to 3800	10	18.6	-
Phase Balance (deg.)	3400 to 3800		182	
Amplitude Balance (dB)	3400 to 3800		0.55	
Insertion Loss (dB)	3400 to 3800	-	0.80	
Power Handling (W)		-		1

Ta = +25+/-5°C

HHM17168B1

FREQUENCY CHARACTERISTICS

Insertion Loss

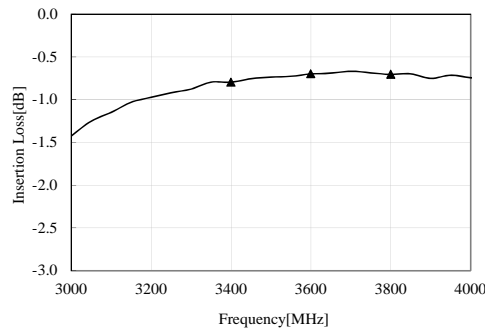

3400 MHz
-0.80 dB
3600 MHz
-0.70 dB
3800 MHz
-0.71 dB

Return Loss

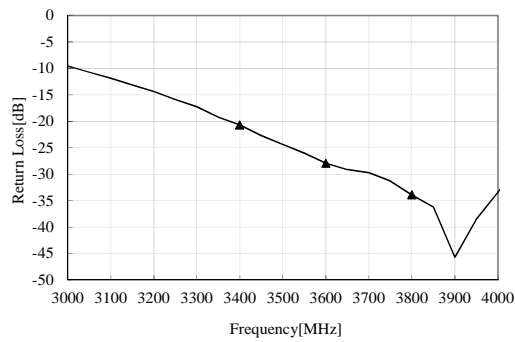

3400 MHz
-20.7 dB
3600 MHz
-27.9 dB
3800 MHz
-33.9 dB

Phase Balance

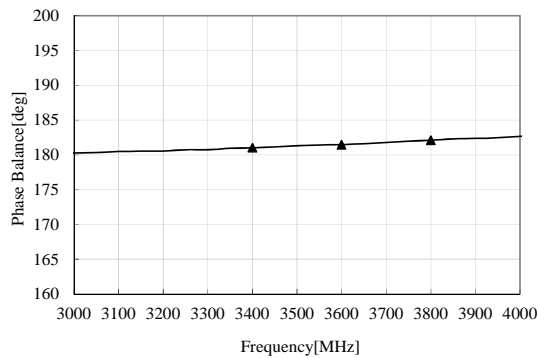

3400 MHz
181 deg
3600 MHz
181 deg
3800 MHz
182 deg

Amplitude Balanc

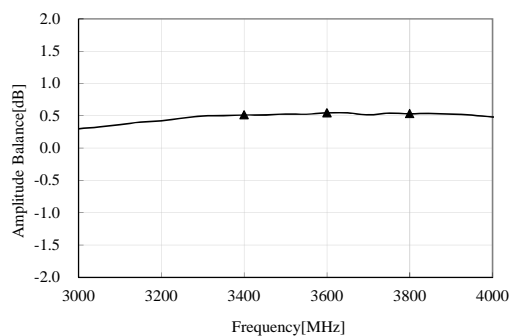

3400 MHz
0.51 dB
3600 MHz
0.55 dB
3800 MHz
0.53 dB

HHM17168B1

■ RECOMMENDED LAND PATTERN

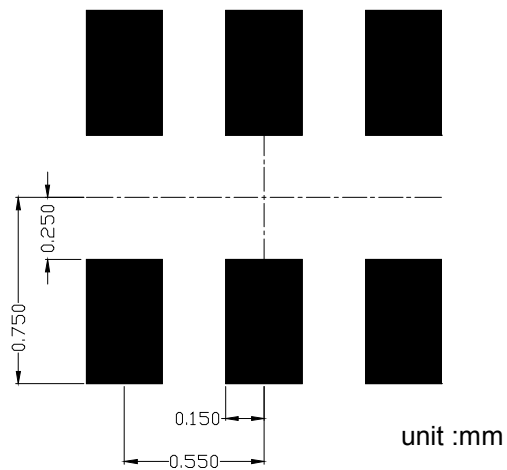

■ ENVIROMENT INFORMATION

RoHS Statement
RoHS Compliance

HHM17168B1

■ RECOMMENDED REFLOW PROFILE

Pb free solder

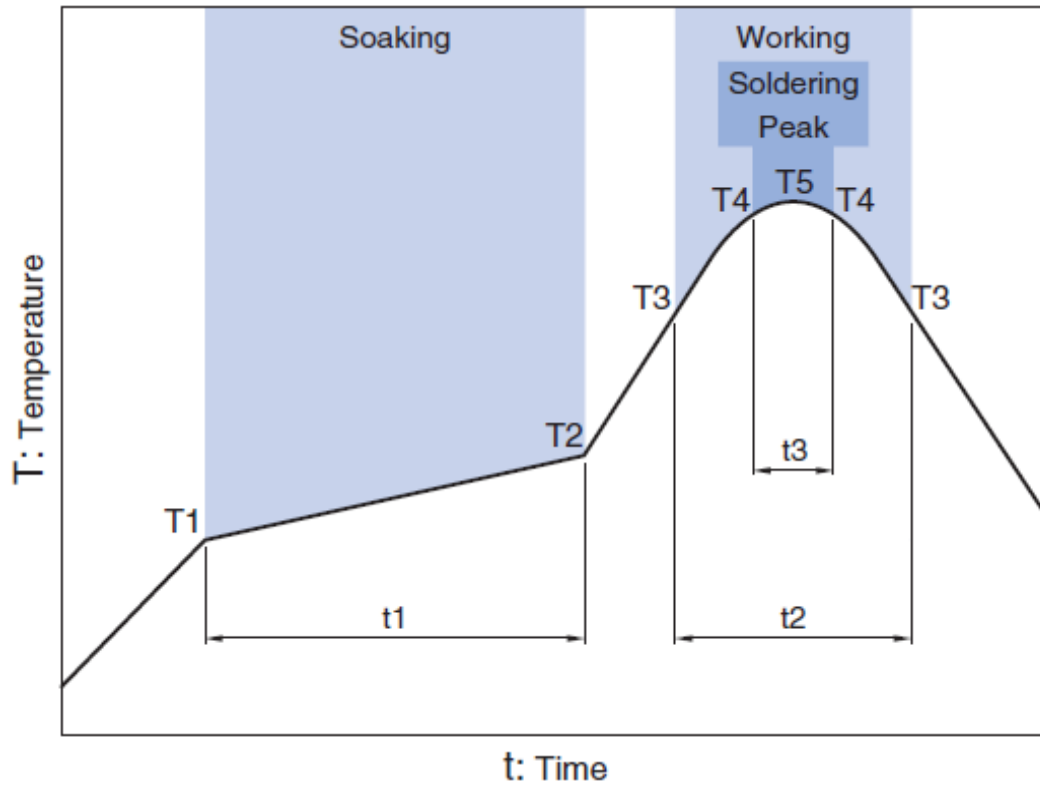

Soaking			Working		Soldering		Peak
Temp.	Temp.	Time	Temp.	Time	Temp.	Time	Temp.
T1	T2	t1	T3	t2	T4	t3	T5
150°C	180°C	60 to 120sec	230°C	more than 30sec	247 to 253°C	within 10sec	260°C Max.

HHM17168B1

PACKAGING STYLE

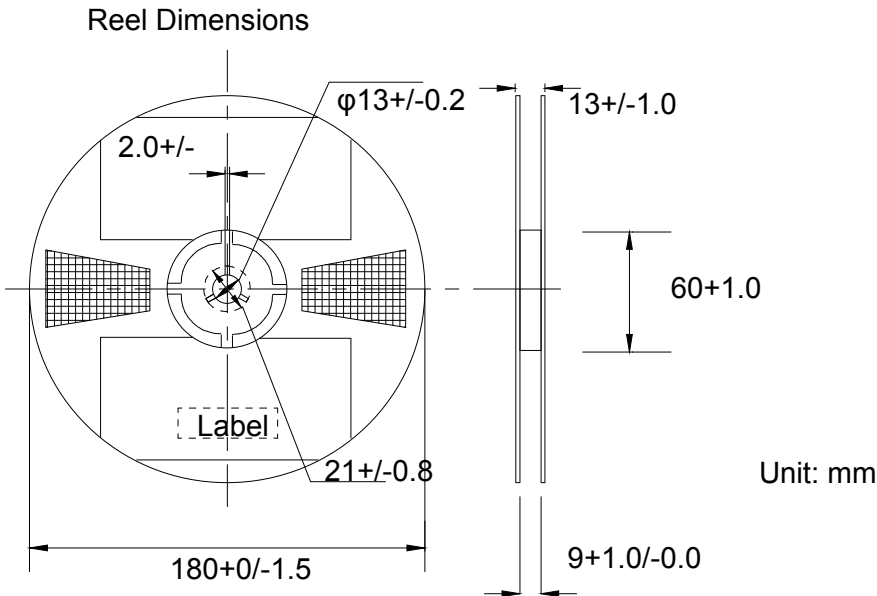

Carrier Tape

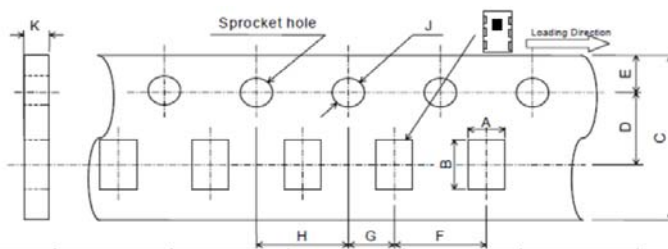

A	B	C	D	E	F
0.97+/-0.05	1.8+/-0.05	8.0+/-0.2	3.5+/-0.05	1.75+/-0.1	4.0±0.1
G	H	J	K		
2.0+/-0.05	4.0+/-0.1	1.5+0.1/-0	0.75+/-0.05		

STANDARD PACKAGE QUANTITY
(pieces/reel)
4,000

REMINDERS FOR USING THESE PRODUCTS

Before using these products, be sure to request the delivery specifications.

SAFETY REMINDERS

Please pay sufficient attention to the warnings for safe designing when using these products.

 REMINDERS
--

The products listed on this specification sheet are intended for use in general electronic equipment (AV equipment, telecommunications equipment, home appliances, amusement equipment, computer equipment, personal equipment, office equipment, measurement equipment, industrial robots) under a normal operation and use condition.

The products are not designed or warranted to meet the requirements of the applications listed below, whose performance and/or quality require a more stringent level of safety or reliability, or whose failure, malfunction or trouble could cause serious damage to society, person or property. Please understand that we are not responsible for any damage or liability caused by use of the products in any of the applications below or for any other use exceeding the range or conditions set forth in this specification sheet.

1. Aerospace/Aviation equipment
2. Transportation equipment (cars, electric trains, ships, etc.)
3. Medical equipment
4. Power-generation control equipment
5. Atomic energy-related equipment
6. Seabed equipment
7. Transportation control equipment
8. Public information-processing equipment
9. Military equipment
10. Electric heating apparatus, burning equipment
11. Disaster prevention/crime prevention equipment
12. Safety equipment
13. Other applications that are not considered general-purpose applications

When using this product in general-purpose applications, you are kindly requested to take into consideration securing protection circuit/equipment or providing backup circuits, etc., to ensure higher safety.



Компания «ЭлектроПласт» предлагает заключение долгосрочных отношений при поставках импортных электронных компонентов на взаимовыгодных условиях!

Наши преимущества:

- Оперативные поставки широкого спектра электронных компонентов отечественного и импортного производства напрямую от производителей и с крупнейших мировых складов;
- Поставка более 17-ти миллионов наименований электронных компонентов;
- Поставка сложных, дефицитных, либо снятых с производства позиций;
- Оперативные сроки поставки под заказ (от 5 рабочих дней);
- Экспресс доставка в любую точку России;
- Техническая поддержка проекта, помощь в подборе аналогов, поставка прототипов;
- Система менеджмента качества сертифицирована по Международному стандарту ISO 9001;
- Лицензия ФСБ на осуществление работ с использованием сведений, составляющих государственную тайну;
- Поставка специализированных компонентов (Xilinx, Altera, Analog Devices, Intersil, Interpoint, Microsemi, Aeroflex, Peregrine, Syfer, Eurofarad, Texas Instrument, Miteq, Cobham, E2V, MA-COM, Hittite, Mini-Circuits, General Dynamics и др.);

Помимо этого, одним из направлений компании «ЭлектроПласт» является направление «Источники питания». Мы предлагаем Вам помощь Конструкторского отдела:

- Подбор оптимального решения, техническое обоснование при выборе компонента;
- Подбор аналогов;
- Консультации по применению компонента;
- Поставка образцов и прототипов;
- Техническая поддержка проекта;
- Защита от снятия компонента с производства.



Как с нами связаться

Телефон: 8 (812) 309 58 32 (многоканальный)

Факс: 8 (812) 320-02-42

Электронная почта: org@eplast1.ru

Адрес: 198099, г. Санкт-Петербург, ул. Калинина, дом 2, корпус 4, литера А.