

1.0mm Pitch
SERIES

6232

1.0mmピッチ NON-ZIF RA SMT
1.0mmPitch LIF RA SMT

上接点 Top contact



下接点 Bottom contact



適用 FPC/FFC
APPLICABLE FPC/FFC

種類 KIND	公差 TOLERANCE		
	P	W	M
FPC	±0.02	+0.1 -0.05	±0.05
FFC	±0.05	±0.03	±0.1

極数 NO. OF POS.	A	B	C
3	2.0	4.1	6.6
4	3.0	5.1	7.6
5	4.0	6.1	8.6
6	5.0	7.1	9.6
7	6.0	8.1	10.6
8	7.0	9.1	11.6
9	8.0	10.1	12.6
10	9.0	11.1	13.6
11	10.0	12.1	14.6
12	11.0	13.1	15.6
13	12.0	14.1	16.6
14	13.0	15.1	17.6
15	14.0	16.1	18.6
16	15.0	17.1	19.6
17	16.0	18.1	20.6
18	17.0	19.1	21.6
19	18.0	20.1	22.6
20	19.0	21.1	23.6
21	20.0	22.1	24.6
22	21.0	23.1	25.6
23	22.0	24.1	26.6
24	23.0	25.1	27.6
25	24.0	26.1	28.6
26	25.0	27.1	29.6
27	26.0	28.1	30.6
28	27.0	29.1	31.6
29	28.0	30.1	32.6
30	29.0	31.1	33.6

注文コード ORDERING CODE

XX 6232 1XX 10X 800+

RoHS 対応品
RoHS Compliant Product

スズ銅めっき Sn-Cu Plated

接点位置 CONTACT POSITION
2: 下接点 BOTTOM CONTACT
3: 上接点 TOP CONTACT

極数 NUMBER OF POSITIONS

00: トレー梱包 TRAY PACKAGE

エンボス梱包品: 04 6232 1XX 10X 800+

Tape & Reel Package: 04 6232 1XX 10X 800+

生産対応可能極数については、営業部にご確認願います。

Feel free to contact our sales department for available numbers of positions.

1.0mm Pitch
SERIES

6232

エンボス梱包品
Tape and Reel Package



SECT. D-D



SECT. D-D



SECT. D-D



SECT. D-D

型番 PART NO.	極数 NO. OF POS	A	B
04 6232 103 10X 800+	3	3.6	6.9
↑ 104	↑ 4	4.6	7.9
105	5	5.6	8.9
106	6	6.6	9.9
107	7	7.6	10.9
108	8	8.6	11.9
↓ 109	↓ 9	9.6	12.9
04 6232 110 10X 800+	10	10.6	13.9

型番 PART NO.	極数 NO. OF POS	A	B
04 6232 111 10X 800+	11	11.6	14.9
↑ 112	↑ 12	12.6	15.9
113	13	13.6	16.9
114	14	14.6	17.9
115	15	15.6	18.9
116	16	16.6	19.9
↓ 117	↓ 17	17.6	20.9
04 6232 118 10X 800+	18	18.6	21.9

型番 PART NO.	極数 NO. OF POS	A	B
04 6232 119 10X 800+	19	19.6	22.9
↑ 120	↑ 20	20.6	23.9
121	21	21.6	24.9
122	22	22.6	25.9
123	23	23.6	26.9
↓ 124	↓ 24	24.6	27.9
04 6232 125 10X 800+	25	25.6	28.9

型番 PART NO.	極数 NO. OF POS	A	B
04 6232 126 10X 800+	26	26.6	29.9
↑ 127	↑ 27	27.6	30.9
128	28	28.6	31.9
↓ 129	↓ 29	29.6	32.9
04 6232 130 10X 800+	30	30.6	33.9



注文コード ORDERING CODE

04 6232 1XX 10X 800+

RoHS 対応品

RoHS Compliant Product

極数
NUMBER
OF
POSITIONS

スズ銅めっき Sn-Cu Plated
バリエーション VARIATION CODE
2: 下接点タイプ ボス無 BOTTOM CONTACT TYPE WITHOUT BOSS
3: 上接点タイプ ボス無 TOP CONTACT TYPE WITHOUT BOSS

トレー梱包品: 00 6232 1XX 10X 800+
TRAY PACKAGE: 00 6232 1XX 10X 800+

生産対応可能極数については、営業部にご確認願います。

Feel free to contact our sales department for available numbers of positions.

梱包数量 1000個/リール
PACKING QUANTITY: 1000/Reel

1.0mm Pitch
SERIES

6232

1.0mmピッチ NON-ZIF ストレート SMT 片面接点
1.0mmPitch LIF Vertical SMT Single-sided contact

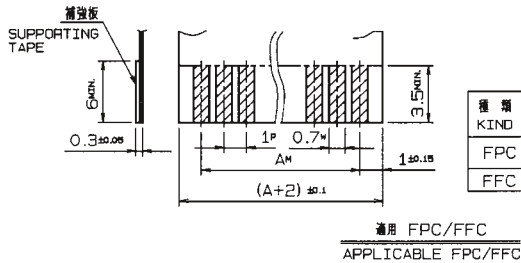
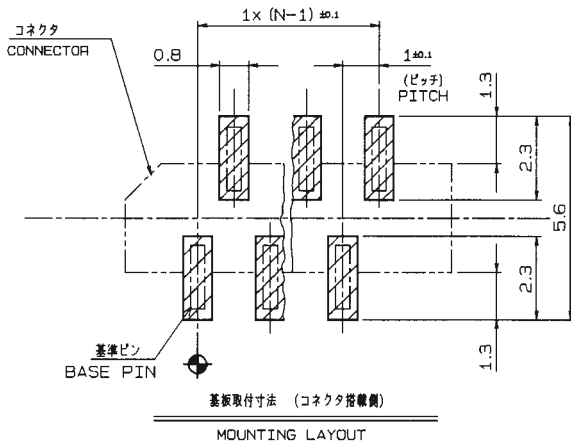

極数 NO. OF POS	型番 ASSEMBLY NUMBER	A	B	C
3	00 6232 103 006 800+	2.0	4.1	6.0
4	↑ 104 ↑	3.0	5.1	7.0
5	105	4.0	6.1	8.0
6	106	5.0	7.1	9.0
7	107	6.0	8.1	10.0
8	108	7.0	9.1	11.0
9	109	8.0	10.1	12.0
10	110	9.0	11.1	13.0
11	111	10.0	12.1	14.0
12	112	11.0	13.1	15.0
13	113	12.0	14.1	16.0
14	114	13.0	15.1	17.0
15	115	14.0	16.1	18.0
16	116	15.0	17.1	19.0
17	117	16.0	18.1	20.0
18	118	17.0	19.1	21.0
19	119	18.0	20.1	22.0
20	120	19.0	21.1	23.0
21	121	20.0	22.1	24.0
22	122	21.0	23.1	25.0
23	123	22.0	24.1	26.0
24	124	23.0	25.1	27.0
25	125	24.0	26.1	28.0
26	126	25.0	27.1	29.0
27	127	26.0	28.1	30.0
28	128	27.0	29.1	31.0
29	↓ 129 ↓	28.0	30.1	32.0
30	00 6232 130 006 800+	29.0	31.1	33.0

注文コード ORDERING CODE

00 6232 1XX 006 800+

RoHS 対応品

RoHS Compliant Product

極数
NUMBER OF POSITIONS

スズ銅めっき Sn-Cu Plated

00: トレー梱包
TRAY PACKAGE

エンボス梱包品: 04 6232 1XX 015 800+
Tape & Reel Package: 04 6232 1XX 015 800+

生産対応可能極数については、営業部にご確認願います。

Feel free to contact our sales department for available numbers of positions.

1.0mm Pitch
SERIES

6232

エンボス梱包品
Tape and Reel Package



型番	極数	A	B	C
04 6232 103 015 800+	3	3.7	6.3	8.7
↑	↑	↑	↑	↑
104	4	4.7	7.3	9.7
105	5	5.7	8.3	10.7
106	6	6.7	9.3	11.7
107	7	7.7	10.3	12.7
108	8	8.7	11.3	13.7
109	9	9.7	12.3	14.7
04 6232 110 015 800+	10	10.7	13.3	15.7



型番	極数	A	B	C
04 6232 111 015 800+	11	11.7	14.3	16.7
↑	↑	↑	↑	↑
112	12	12.7	15.3	17.7
113	13	13.7	16.3	18.7
114	14	14.7	17.3	19.7
115	15	15.7	18.3	20.7
116	16	16.7	19.3	21.7
117	17	17.7	20.3	22.7
04 6232 118 015 800+	18	18.7	21.3	23.7



型番	極数	A	B	C
04 6232 119 015 800+	19	19.7	22.3	24.7
↑	↑	↑	↑	↑
120	20	20.7	23.3	25.7
121	21	21.7	24.3	26.7
122	22	22.7	25.3	27.7
123	23	23.7	26.3	28.7
124	24	24.7	27.3	29.7
04 6232 125 015 800+	25	25.7	28.3	30.7



型番	極数	A	B	C
04 6232 126 015 800+	26	26.7	29.3	31.7
↑	↑	↑	↑	↑
127	27	27.7	30.3	32.7
128	28	28.7	31.3	33.7
129	29	29.7	32.3	34.7
04 6232 130 015 800+	30	30.7	33.3	35.7



注文コード ORDERING CODE

04 6232 1XX 015 800+

RoHS 対応品

RoHS Compliant Product

04 : エンボス梱包
Tape & Reel

極数

NUMBER OF
POSITIONS

スズ銅めっき Sn-Cu Plated

トレー梱包品 : 00 6232 1XX 006 800+
Tray Package : 00 6232 1XX 006 800+

生産対応可能極数については、営業部にご確認願います。

Feel free to contact our sales department for available numbers of positions.

梱包数量 900個/リール
PACKING QUANTITY : 900/Reel

1.0mm Pitch
SERIES

6232

1.0mmピッチ NON-ZIF RA DIP 下接点

1.0mmPitch LIF RA Through hole Bottom contact



極数 NO. OF POS	型番 ASSEMBLY NUMBER	A	B	C
3	00 6232 003 104 800+	2.0	4.1	6.0
4	↑ 004 ↑	3.0	5.1	7.0
5	005	4.0	6.1	8.0
6	006	5.0	7.1	9.0
7	007	6.0	8.1	10.0
8	008	7.0	9.1	11.0
9	009	8.0	10.1	12.0
10	010	9.0	11.1	13.0
11	011	10.0	12.1	14.0
12	012	11.0	13.1	15.0
13	013	12.0	14.1	16.0
14	014	13.0	15.1	17.0
15	015	14.0	16.1	18.0
16	016	15.0	17.1	19.0
17	017	16.0	18.1	20.0
18	018	17.0	19.1	21.0
19	019	18.0	20.1	22.0
20	020	19.0	21.1	23.0
21	021	20.0	22.1	24.0
22	022	21.0	23.1	25.0
23	023	22.0	24.1	26.0
24	024	23.0	25.1	27.0
25	025	24.0	26.1	28.0
26	026	25.0	27.1	29.0
27	027	26.0	28.1	30.0
28	028	27.0	29.1	31.0
29	029	28.0	30.1	32.0
30	00 6232 030 104 800+	29.0	31.1	33.0

種類 KIND	公差 TOLERANCE		
	P	W	M
FPC	±0.02	+0.1 -0.05	±0.05
FFC	±0.05	±0.03	±0.1

適用 FPC/FFC
APPLICABLE FPC/FFC

注文コード ORDERING CODE
00 6232 0XX 104 800+

RoHS 対応品
RoHS Compliant Product

00: トレー梱包
TRAY PACKAGE

極数 NUMBER OF POSITIONS

スズめっき Sn Plated

生産対応可能極数については、営業部にご確認願います。

Feel free to contact our sales department for available numbers of positions.

1.0mm Pitch
SERIES

6232

1.0mmピッチ NON-ZIF ストレート DIP 片面接点
1.0mmPitch LIF Vertical Through hole Single-sided contact

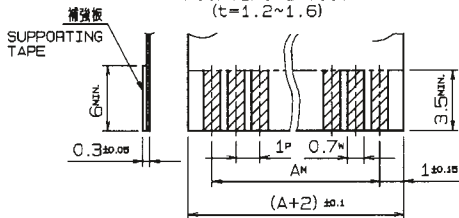
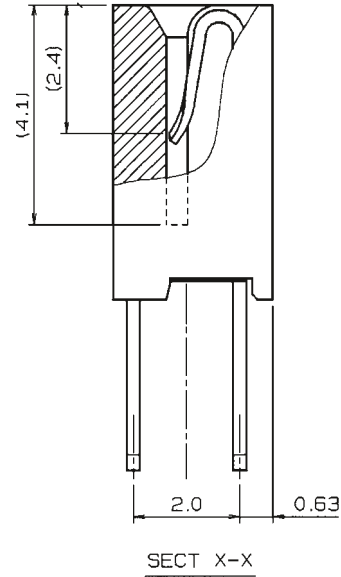
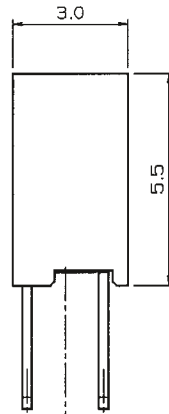
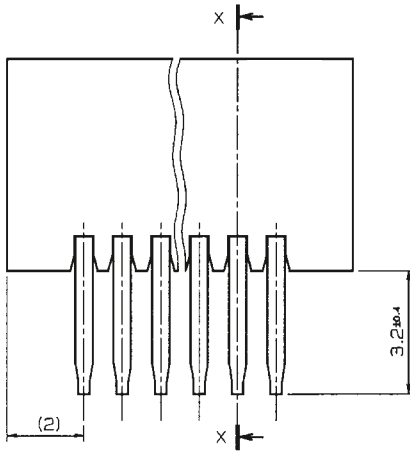
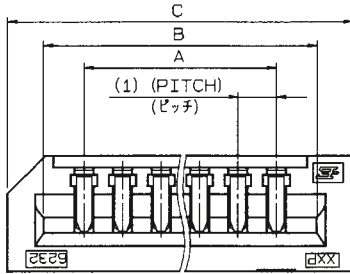

種類 KIND	公差 TOLERANCE		
	P	W	M
FPC	±0.02	+0.1 -0.05	±0.05
FFC	±0.05	±0.03	±0.1

適用 FPC/FFC
APPLICABLE FPC/FFC

極数 NO. OF POS	型番 ASSEMBLY NUMBER	A	B	C
3	00 6232 003 XXX 800+	2.0	4.1	6.0
4	↑ 004 ↑	3.0	5.1	7.0
5	005	4.0	6.1	8.0
6	006	5.0	7.1	9.0
7	007	6.0	8.1	10.0
8	008	7.0	9.1	11.0
9	009	8.0	10.1	12.0
10	010	9.0	11.1	13.0
11	011	10.0	12.1	14.0
12	012	11.0	13.1	15.0
13	013	12.0	14.1	16.0
14	014	13.0	15.1	17.0
15	015	14.0	16.1	18.0
16	016	15.0	17.1	19.0
17	017	16.0	18.1	20.0
18	018	17.0	19.1	21.0
19	019	18.0	20.1	22.0
20	020	19.0	21.1	23.0
21	021	20.0	22.1	24.0
22	022	21.0	23.1	25.0
23	023	22.0	24.1	26.0
24	024	23.0	25.1	27.0
25	025	24.0	26.1	28.0
26	026	25.0	27.1	29.0
27	027	26.0	28.1	30.0
28	028	27.0	29.1	31.0
29	↓ 029 ↓	28.0	30.1	32.0
30	00 6232 030 XXX 800+	29.0	31.1	33.0

注文コード ORDERING CODE

00 6232 0XX XXX 800+

00: トレー梱包
TRAY PACKAGE

極数
NUMBER
OF
POSITIONS

バリエーション VARIATION CODE
006: キング付 WITH KINK
007: キング無 WITHOUT KINK

RoHS 対応品
RoHS Compliant Product

スズめっき Sn Plated

生産対応可能極数については、営業部にご確認願います。

Feel free to contact our sales department for available numbers of positions.



Компания «ЭлектроПласт» предлагает заключение долгосрочных отношений при поставках импортных электронных компонентов на взаимовыгодных условиях!

Наши преимущества:

- Оперативные поставки широкого спектра электронных компонентов отечественного и импортного производства напрямую от производителей и с крупнейших мировых складов;
- Поставка более 17-ти миллионов наименований электронных компонентов;
- Поставка сложных, дефицитных, либо снятых с производства позиций;
- Оперативные сроки поставки под заказ (от 5 рабочих дней);
- Экспресс доставка в любую точку России;
- Техническая поддержка проекта, помощь в подборе аналогов, поставка прототипов;
- Система менеджмента качества сертифицирована по Международному стандарту ISO 9001;
- Лицензия ФСБ на осуществление работ с использованием сведений, составляющих государственную тайну;
- Поставка специализированных компонентов (Xilinx, Altera, Analog Devices, Intersil, Interpoint, Microsemi, Aeroflex, Peregrine, Syfer, Eurofarad, Texas Instrument, Miteq, Cobham, E2V, MA-COM, Hittite, Mini-Circuits, General Dynamics и др.);

Помимо этого, одним из направлений компании «ЭлектроПласт» является направление «Источники питания». Мы предлагаем Вам помощь Конструкторского отдела:

- Подбор оптимального решения, техническое обоснование при выборе компонента;
- Подбор аналогов;
- Консультации по применению компонента;
- Поставка образцов и прототипов;
- Техническая поддержка проекта;
- Защита от снятия компонента с производства.



Как с нами связаться

Телефон: 8 (812) 309 58 32 (многоканальный)

Факс: 8 (812) 320-02-42

Электронная почта: org@eplast1.ru

Адрес: 198099, г. Санкт-Петербург, ул. Калинина, дом 2, корпус 4, литера А.