

## Phase Control Thyristors (Hockey PUK Version), 960 A



TO-200AB (E-PUK)

**RoHS  
COMPLIANT**
**FEATURES**

- Center amplifying gate
- Metal case with ceramic insulator
- International standard case TO-200AB (E-PUK)
- Extended temperature range
- Low profile hockey PUK to increase current-carrying capability
- Designed and qualified for industrial level
- Material categorization: For definitions of compliance please see [www.vishay.com/doc?99912](http://www.vishay.com/doc?99912)

**TYPICAL APPLICATIONS**

- DC motor controls
- Controlled DC power supplies
- AC controllers

PRODUCT SUMMARY	
Package	TO-200AB (E-PUK)
Diode variation	Single SCR
$I_{T(AV)}$	960 A
$V_{DRM}/V_{RRM}$	400 V, 600 V
$V_{TM}$	1.58 V
$I_{GT}$	100 mA
$T_J$	-40 °C to 150 °C

MAJOR RATINGS AND CHARACTERISTICS			
PARAMETER	TEST CONDITIONS	VALUES	UNITS
$I_{T(AV)}$		960	A
	$T_{hs}$	80	°C
$I_{T(RMS)}$		2220	A
	$T_{hs}$	25	°C
$I_{TSM}$	50 Hz	12 500	A
	60 Hz	13 000	
$I^2t$	50 Hz	782	kA <sup>2</sup> s
	60 Hz	713	
$V_{DRM}/V_{RRM}$		400 to 600	V
$t_q$	Typical	100	μs
$T_J$		-40 to 150	°C

**ELECTRICAL SPECIFICATIONS**

VOLTAGE RATINGS				
TYPE NUMBER	VOLTAGE CODE	$V_{DRM}/V_{RRM}$ , MAXIMUM REPETITIVE PEAK AND OFF-STATE VOLTAGE V	$V_{RSM}$ , MAXIMUM NON-REPETITIVE PEAK VOLTAGE V	$I_{DRM}/I_{RRM}$ MAXIMUM AT $T_J = T_J$ MAXIMUM mA
VS-ST380CH..C	04	400	500	100
	06	600	700	



<b>ABSOLUTE MAXIMUM RATINGS</b>					
PARAMETER	SYMBOL	TEST CONDITIONS		VALUES	UNITS
Maximum average on-state current at heatsink temperature	$I_{T(AV)}$	180° conduction, half sine wave double side (single side) cooled		960 (440)	A
				80 (110)	°C
Maximum RMS on-state current	$I_{T(RMS)}$	DC at 25 °C heatsink temperature double side cooled		2220	
Maximum peak, one-cycle non-repetitive surge current	$I_{TSM}$	t = 10 ms	No voltage reapplied	12 500	A
		t = 8.3 ms		13 000	
		t = 10 ms	100 % $V_{RRM}$ reapplied	10 500	
		t = 8.3 ms		11 000	
Maximum $I^2t$ for fusing	$I^2t$	t = 10 ms	No voltage reapplied	782	kA <sup>2</sup> s
		t = 8.3 ms		713	
		t = 10 ms	100 % $V_{RRM}$ reapplied	553	
		t = 8.3 ms		505	
Maximum $I^2\sqrt{t}$ for fusing	$I^2\sqrt{t}$	t = 0.1 to 10 ms, no voltage reapplied		7820	kA <sup>2</sup> √s
Low level value of threshold voltage	$V_{T(TO)1}$	(16.7 % $\times \pi \times I_{T(AV)} < I < \pi \times I_{T(AV)}$ ), $T_J = T_J$ maximum		0.85	V
High level value of threshold voltage	$V_{T(TO)2}$	(I > $\pi \times I_{T(AV)}$ ), $T_J = T_J$ maximum		0.88	
Low level value of on-state slope resistance	$r_{t1}$	(16.7 % $\times \pi \times I_{T(AV)} < I < \pi \times I_{T(AV)}$ ), $T_J = T_J$ maximum		0.25	mΩ
High level value of on-state slope resistance	$r_{t2}$	(I > $\pi \times I_{T(AV)}$ ), $T_J = T_J$ maximum		0.24	
Maximum on-state voltage	$V_{TM}$	$I_{pk} = 2900$ A, $T_J = T_J$ maximum, $t_p = 10$ ms sine pulse		1.58	V
Maximum holding current	$I_H$	$T_J = 25$ °C, anode supply 12 V resistive load		600	mA
Typical latching current	$I_L$			1000	

<b>SWITCHING</b>					
PARAMETER	SYMBOL	TEST CONDITIONS		VALUES	UNITS
Maximum non-repetitive rate of rise of turned-on current	$di/dt$	Gate drive 20 V, 20 Ω, $t_r \leq 1$ μs $T_J = T_J$ maximum, anode voltage $\leq 80$ % $V_{DRM}$		1000	A/μs
Typical delay time	$t_d$	Gate current 1 A, $di_g/dt = 1$ A/μs $V_d = 0.67$ % $V_{DRM}$ , $T_J = 25$ °C		1.0	μs
Typical turn-off time	$t_q$	$I_{TM} = 550$ A, $T_J = T_J$ maximum, $di/dt = 40$ A/μs, $V_R = 50$ V, $dV/dt = 20$ V/μs, gate 0 V 100 Ω, $t_p = 500$ μs		100	

<b>BLOCKING</b>					
PARAMETER	SYMBOL	TEST CONDITIONS		VALUES	UNITS
Maximum critical rate of rise of off-state voltage	$dV/dt$	$T_J = T_J$ maximum linear to 80 % rated $V_{DRM}$		500	V/μs
Maximum peak reverse and off-state leakage current	$I_{RRM}$ , $I_{DRM}$	$T_J = T_J$ maximum, rated $V_{DRM}/V_{RRM}$ applied		100	mA



<b>TRIGGERING</b>						
PARAMETER	SYMBOL	TEST CONDITIONS		VALUES		UNITS
				TYP.	MAX.	
Maximum peak gate power	$P_{GM}$	$T_J = T_J$ maximum, $t_p \leq 5$ ms		10.0		W
Maximum average gate power	$P_{G(AV)}$	$T_J = T_J$ maximum, $f = 50$ Hz, $d\% = 50$		2.0		
Maximum peak positive gate current	$I_{GM}$	$T_J = T_J$ maximum, $t_p \leq 5$ ms		3.0		A
Maximum peak positive gate voltage	$+V_{GM}$	$T_J = T_J$ maximum, $t_p \leq 5$ ms		20		V
Maximum peak negative gate voltage	$-V_{GM}$			5.0		
DC gate current required to trigger	$I_{GT}$	$T_J = -40$ °C	Maximum required gate trigger/ current/voltage are the lowest value which will trigger all units 12 V anode to cathode applied	200	-	mA
		$T_J = 25$ °C		100	200	
		$T_J = 150$ °C		40	-	
DC gate voltage required to trigger	$V_{GT}$	$T_J = -40$ °C		2.5	-	V
		$T_J = 25$ °C		1.8	3.0	
		$T_J = 150$ °C		1.0	-	
DC gate current not to trigger	$I_{GD}$	$T_J = T_J$ maximum	Maximum gate current/voltage not to trigger is the maximum value which will not trigger any unit with rated $V_{DRM}$ anode to cathode applied	10		mA
DC gate voltage not to trigger	$V_{GD}$			0.25		V

<b>THERMAL AND MECHANICAL SPECIFICATIONS</b>				
PARAMETER	SYMBOL	TEST CONDITIONS	VALUES	UNITS
Maximum operating junction temperature range	$T_J$		-40 to 150	°C
Maximum storage temperature range	$T_{Stg}$			
Maximum thermal resistance, junction to heatsink	$R_{thJ-hs}$	DC operation single side cooled	0.09	K/W
		DC operation double side cooled	0.04	
Maximum thermal resistance, case to heatsink	$R_{thC-hs}$	DC operation single side cooled	0.02	
		DC operation double side cooled	0.01	
Mounting force, $\pm 10$ %			9800 (1000)	N (kg)
Approximate weight			83	g
Case style		See dimensions - link at the end of datasheet	TO-200AB (E-PUK)	

<b><math>\Delta R_{thJ-hs}</math> CONDUCTION</b>						
CONDUCTION ANGLE	SINUSOIDAL CONDUCTION		RECTANGULAR CONDUCTION		TEST CONDITIONS	UNITS
	SINGLE SIDE	DOUBLE SIDE	SINGLE SIDE	DOUBLE SIDE		
180°	0.010	0.011	0.007	0.007	$T_J = T_J$ maximum	K/W
120°	0.012	0.012	0.012	0.013		
90°	0.015	0.015	0.016	0.017		
60°	0.022	0.022	0.023	0.023		
30°	0.036	0.036	0.036	0.037		

**Note**

- The table above shows the increment of thermal resistance  $R_{thJ-hs}$  when devices operate at different conduction angles than DC

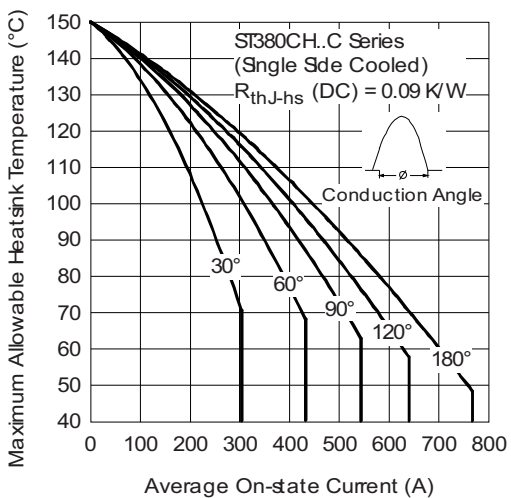

Fig. 1 - Current Ratings Characteristics

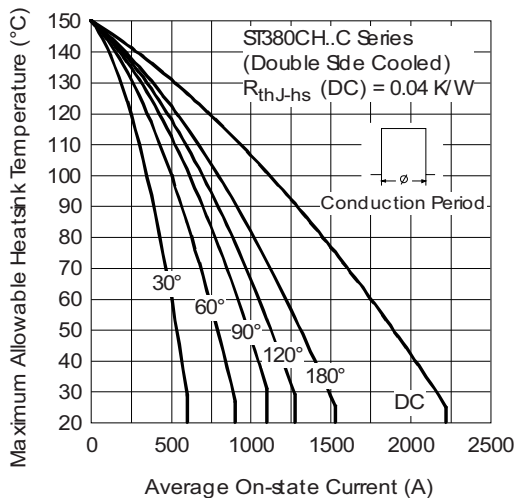

Fig. 4 - Current Ratings Characteristics

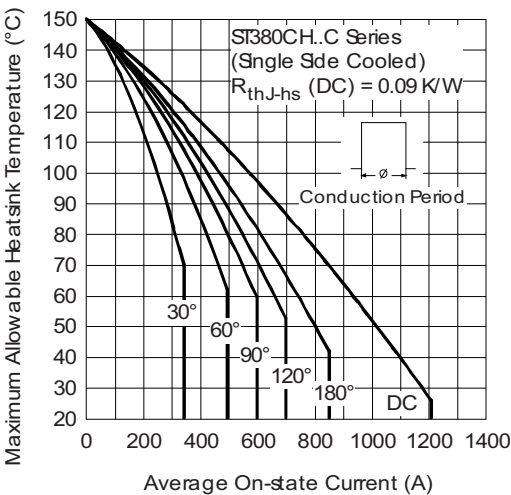

Fig. 2 - Current Ratings Characteristics

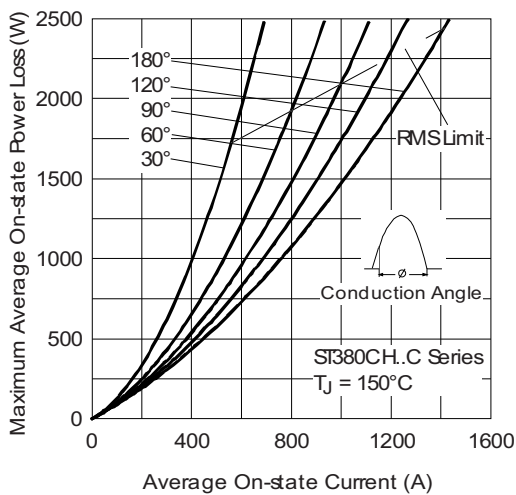

Fig. 5 - On-State Power Loss Characteristics

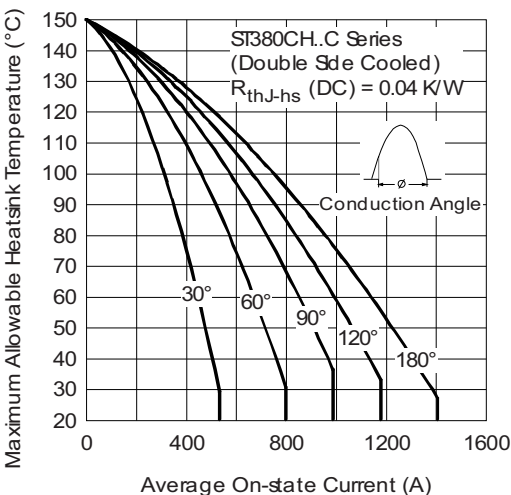

Fig. 3 - Current Ratings Characteristics

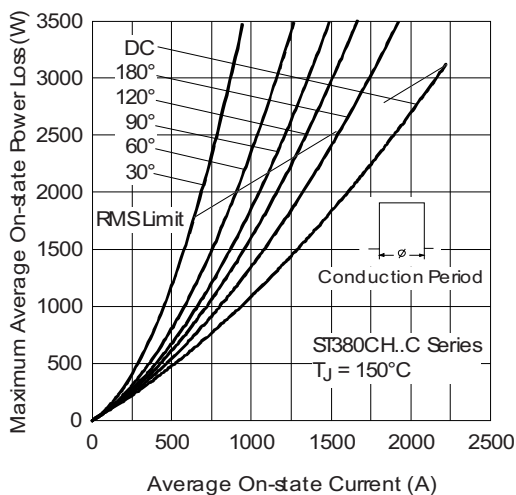

Fig. 6 - On-State Power Loss Characteristics

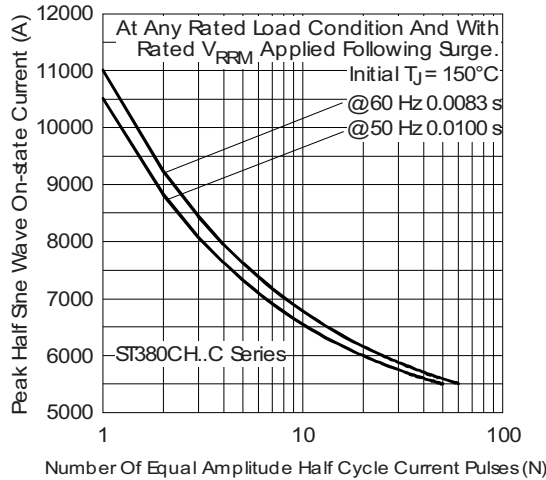

Fig. 7 - Maximum Non-Repetitive Surge Current Single and Double Side Cooled

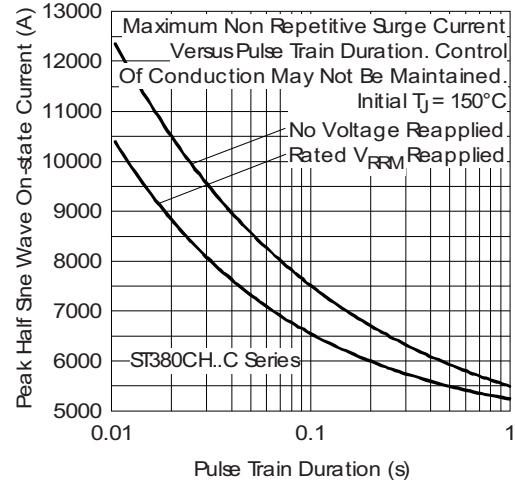

Fig. 8 - Maximum Non-Repetitive Surge Current Single and Double Side Cooled

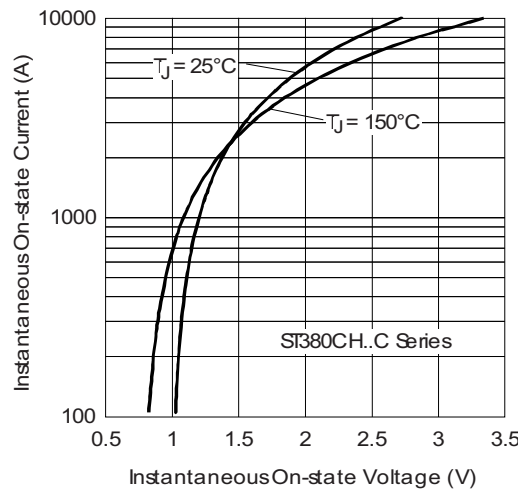

Fig. 9 - On-State Voltage Drop Characteristics

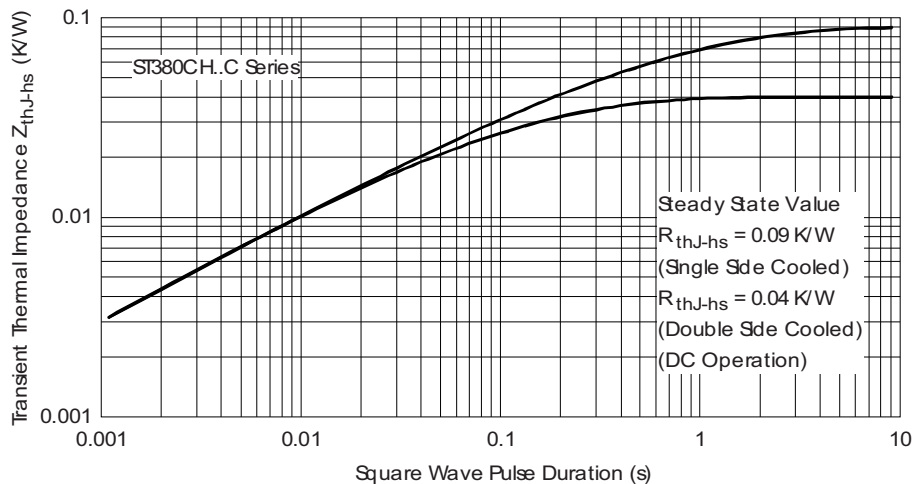

Fig. 10 - Thermal Impedance  $Z_{thJ-hs}$  Characteristics

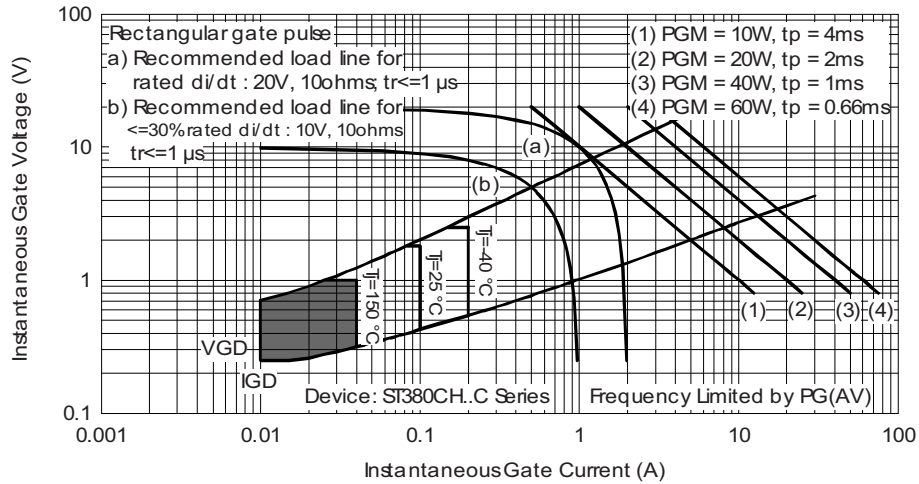

Fig. 11 - Gate Characteristics

## ORDERING INFORMATION TABLE

Device code	<b>VS-</b>	<b>ST</b>	<b>38</b>	<b>0</b>	<b>CH</b>	<b>06</b>	<b>C</b>	<b>1</b>	<b>-</b>
	(1)	(2)	(3)	(4)	(5)	(6)	(7)	(8)	(9)

- 1** - Vishay Semiconductors product
- 2** - Thyristor
- 3** - Essential part number
- 4** - 0 = Converter grade
- 5** - CH = Ceramic PUK, high temperature
- 6** - Voltage code x 100 =  $V_{RRM}$  (see Voltage Ratings table)
- 7** - C = PUK case TO-200AB (E-PUK)
- 8** - 0 = Eyelet terminals (gate and auxiliary cathode unsoldered leads)  
 1 = Fast-on terminals (gate and auxiliary cathode unsoldered leads)  
 2 = Eyelet terminals (gate and auxiliary cathode soldered leads)  
 3 = Fast-on terminals (gate and auxiliary cathode soldered leads)
- 9** - Critical  $dV/dt$ : • None = 500 V/ $\mu s$  (standard selection)  
 • L = 1000 V/ $\mu s$  (special selection)

### LINKS TO RELATED DOCUMENTS

Dimensions	<a href="http://www.vishay.com/doc?95075">http://www.vishay.com/doc?95075</a>
------------	---

## TO-200AB (E-PUK)

**DIMENSIONS** in millimeters (inches)

Anode to gate  
 Creepage distance: 11.18 (0.44) minimum  
 Strike distance: 7.62 (0.30) minimum

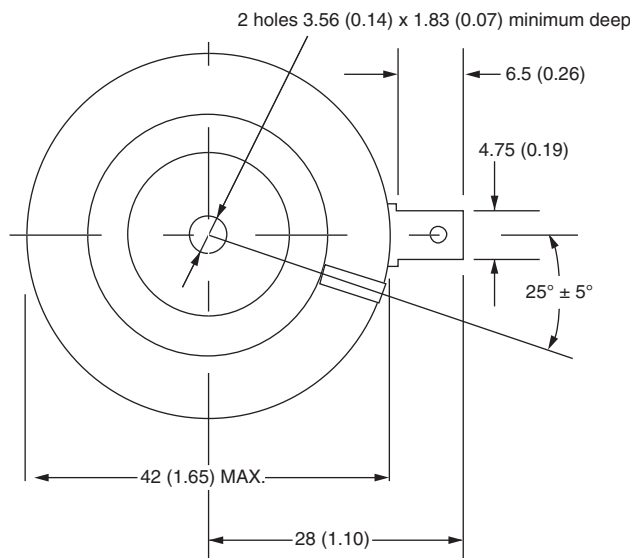

Quote between upper and lower pole pieces has to be considered after application of mounting force (see thermal and mechanical specification)



## Disclaimer

ALL PRODUCT, PRODUCT SPECIFICATIONS AND DATA ARE SUBJECT TO CHANGE WITHOUT NOTICE TO IMPROVE RELIABILITY, FUNCTION OR DESIGN OR OTHERWISE.

Vishay Intertechnology, Inc., its affiliates, agents, and employees, and all persons acting on its or their behalf (collectively, "Vishay"), disclaim any and all liability for any errors, inaccuracies or incompleteness contained in any datasheet or in any other disclosure relating to any product.

Vishay makes no warranty, representation or guarantee regarding the suitability of the products for any particular purpose or the continuing production of any product. To the maximum extent permitted by applicable law, Vishay disclaims (i) any and all liability arising out of the application or use of any product, (ii) any and all liability, including without limitation special, consequential or incidental damages, and (iii) any and all implied warranties, including warranties of fitness for particular purpose, non-infringement and merchantability.

Statements regarding the suitability of products for certain types of applications are based on Vishay's knowledge of typical requirements that are often placed on Vishay products in generic applications. Such statements are not binding statements about the suitability of products for a particular application. It is the customer's responsibility to validate that a particular product with the properties described in the product specification is suitable for use in a particular application. Parameters provided in datasheets and/or specifications may vary in different applications and performance may vary over time. All operating parameters, including typical parameters, must be validated for each customer application by the customer's technical experts. Product specifications do not expand or otherwise modify Vishay's terms and conditions of purchase, including but not limited to the warranty expressed therein.

Except as expressly indicated in writing, Vishay products are not designed for use in medical, life-saving, or life-sustaining applications or for any other application in which the failure of the Vishay product could result in personal injury or death. Customers using or selling Vishay products not expressly indicated for use in such applications do so at their own risk. Please contact authorized Vishay personnel to obtain written terms and conditions regarding products designed for such applications.

No license, express or implied, by estoppel or otherwise, to any intellectual property rights is granted by this document or by any conduct of Vishay. Product names and markings noted herein may be trademarks of their respective owners.

## Material Category Policy

**Vishay Intertechnology, Inc. hereby certifies that all its products that are identified as RoHS-Compliant fulfill the definitions and restrictions defined under Directive 2011/65/EU of The European Parliament and of the Council of June 8, 2011 on the restriction of the use of certain hazardous substances in electrical and electronic equipment (EEE) - recast, unless otherwise specified as non-compliant.**

**Please note that some Vishay documentation may still make reference to RoHS Directive 2002/95/EC. We confirm that all the products identified as being compliant to Directive 2002/95/EC conform to Directive 2011/65/EU.**

**Vishay Intertechnology, Inc. hereby certifies that all its products that are identified as Halogen-Free follow Halogen-Free requirements as per JEDEC JS709A standards. Please note that some Vishay documentation may still make reference to the IEC 61249-2-21 definition. We confirm that all the products identified as being compliant to IEC 61249-2-21 conform to JEDEC JS709A standards.**





Компания «ЭлектроПласт» предлагает заключение долгосрочных отношений при поставках импортных электронных компонентов на взаимовыгодных условиях!

Наши преимущества:

- Оперативные поставки широкого спектра электронных компонентов отечественного и импортного производства напрямую от производителей и с крупнейших мировых складов;
- Поставка более 17-ти миллионов наименований электронных компонентов;
- Поставка сложных, дефицитных, либо снятых с производства позиций;
- Оперативные сроки поставки под заказ (от 5 рабочих дней);
- Экспресс доставка в любую точку России;
- Техническая поддержка проекта, помощь в подборе аналогов, поставка прототипов;
- Система менеджмента качества сертифицирована по Международному стандарту ISO 9001;
- Лицензия ФСБ на осуществление работ с использованием сведений, составляющих государственную тайну;
- Поставка специализированных компонентов (Xilinx, Altera, Analog Devices, Intersil, Interpoint, Microsemi, Aeroflex, Peregrine, Syfer, Eurofarad, Texas Instrument, Miteq, Cobham, E2V, MA-COM, Hittite, Mini-Circuits, General Dynamics и др.);

Помимо этого, одним из направлений компании «ЭлектроПласт» является направление «Источники питания». Мы предлагаем Вам помощь Конструкторского отдела:

- Подбор оптимального решения, техническое обоснование при выборе компонента;
- Подбор аналогов;
- Консультации по применению компонента;
- Поставка образцов и прототипов;
- Техническая поддержка проекта;
- Защита от снятия компонента с производства.



#### Как с нами связаться

**Телефон:** 8 (812) 309 58 32 (многоканальный)

**Факс:** 8 (812) 320-02-42

**Электронная почта:** [org@eplast1.ru](mailto:org@eplast1.ru)

**Адрес:** 198099, г. Санкт-Петербург, ул. Калинина, дом 2, корпус 4, литера А.