

MODULAR CONNECTORS

CL 222 TM

Wire Lead Jack Type

●TM1R-616B44-*

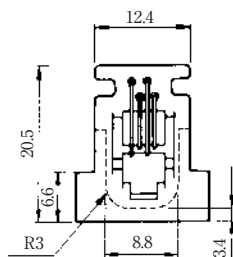
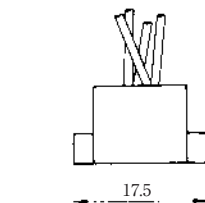
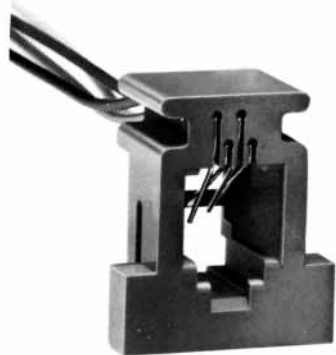

CL No.	Part No.	RoHS
222-4465-0	TM1R-616B44-35S-150M	YES

Color	L (mm)
Yellow	150
Green	150
Red	150
Black	150

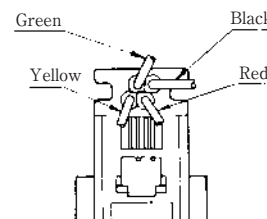
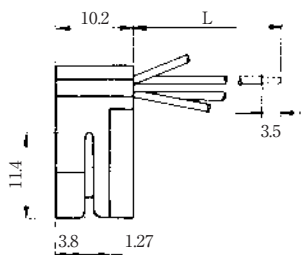

Note: Standard finish color is gray.

●TM1R-616P44-*

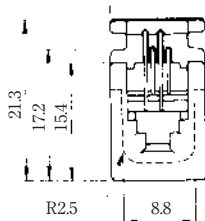
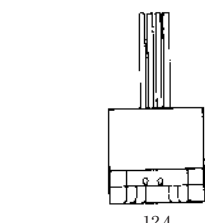
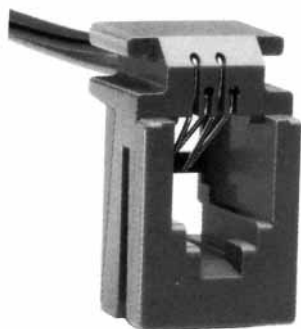

CL No.	Part No.	RoHS
222-4466-2	TM1R-616P44-35S-150M	YES

Color	L (mm)
Yellow	150
Green	150
Red	150
Black	150

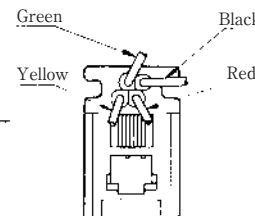
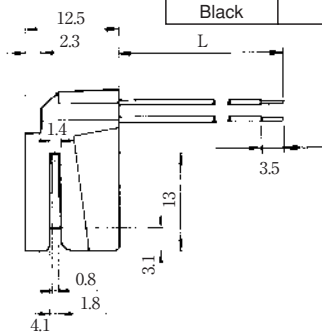

Note: Standard finish color is gray.

●TM1R-616M44-*

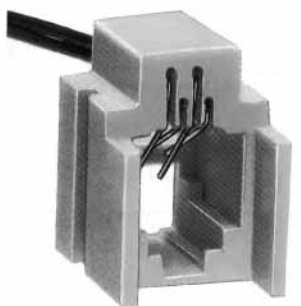

CL No.	Part No.	RoHS
222-4451-5	TM1R-616M44-35S-70M	YES

Color	L (mm)
Yellow	70
Green	70
Red	70
Black	70

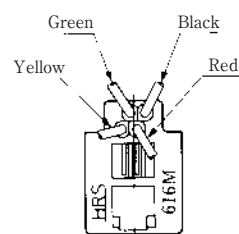
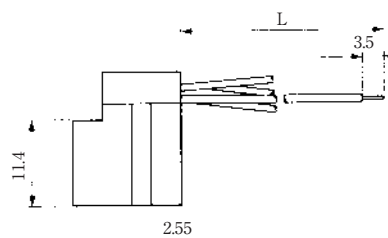

Note: Standard finish color is gray.

MODULAR CONNECTORS

CL 222 TM

TM1R-616W44-*

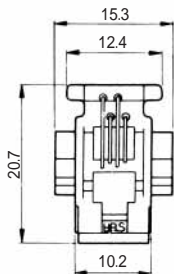
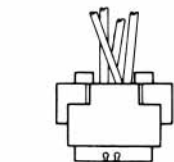
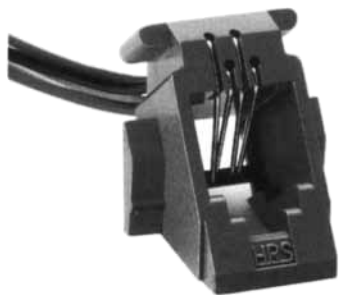

CL No.	Part No.	RoHS
222-4441-1	TM1R-616W44-4S-150M	YES

Color	L (mm)
Yellow	150
Green	150
Red	150
Black	150



Note: Standard finish color is gray.

TM2RD-F44-*

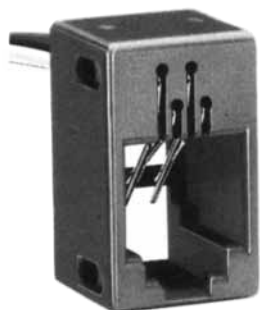

CL No.	Part No.	RoHS
222-4467-5	TM2RD-F44-4S-150M	YES

Color	L (mm)
Yellow	150
Green	150
Red	150
Black	150

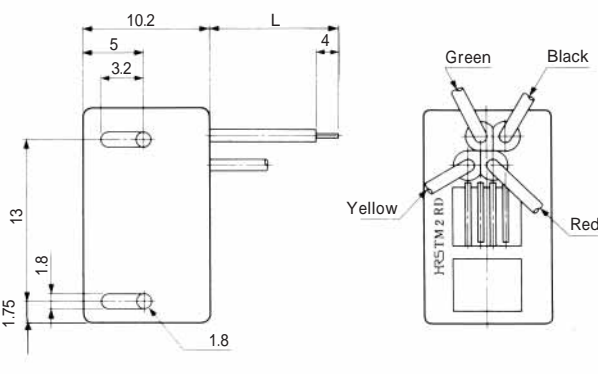

Note: Standard finish color is warm gray.

TM2RDA-F44-*

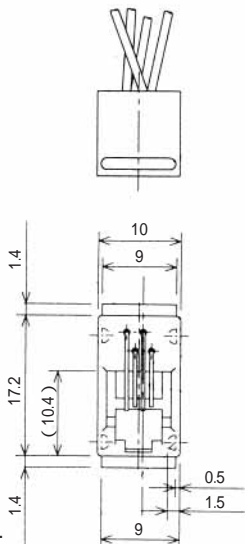
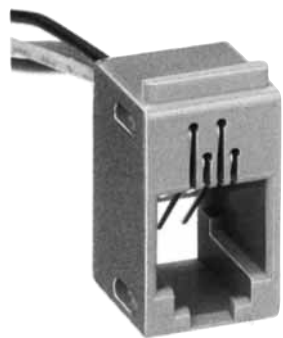

CL No.	Part No.	RoHS
CL222-4440-9	TM2RDA-F44-4S-150M	YES

Color	L (mm)
Yellow	150
Green	150
Red	150
Black	150

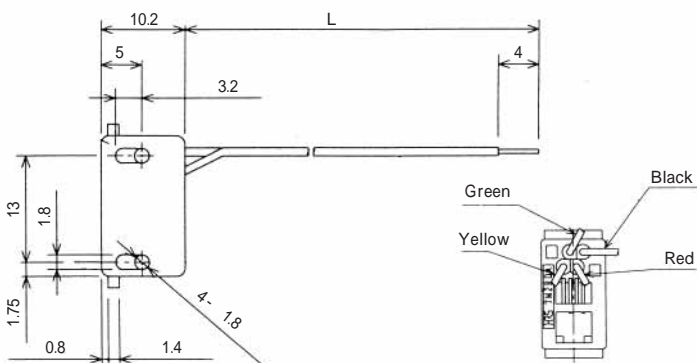

Note: Standard finish color is warm gray.

MODULAR CONNECTORS

CL 222 TM

TM6RA-144- *

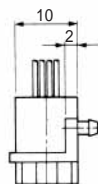
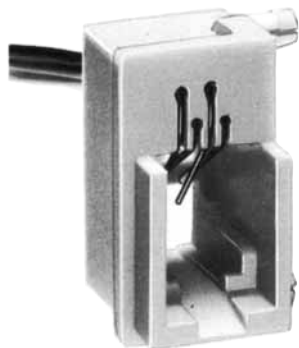

CL No.	Part No.	RoHS
222-4474-0	TM6RA-144-35S-150M	YES

Color	L (mm)
Yellow	150
Green	150
Red	150
Black	150

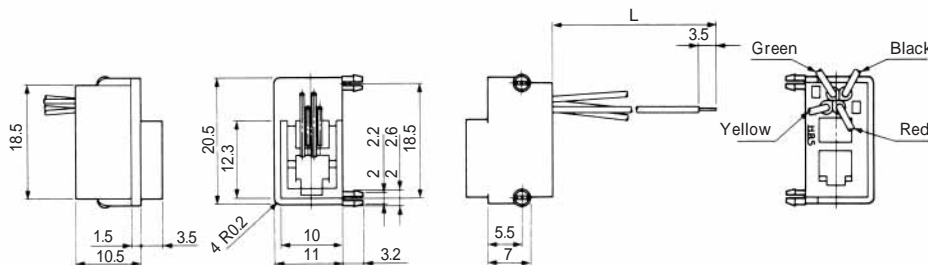

Note: Standard finish color is ash gray.

TM1RV-623K66- *
 TM1RV-623K64- *
 TM1RV-623K62- *

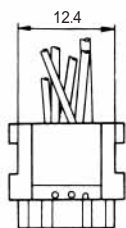
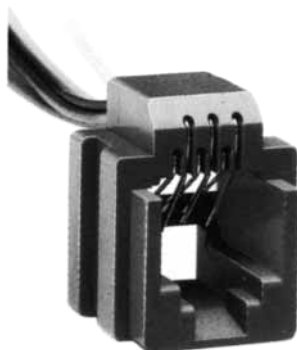

CL No.	Part No.	RoHS
222-4307-9	TM1RV-623K66-4S-150M	YES

Color	L (mm)
White	150
Yellow	150
Green	150
Red	150
Black	150
Blue	150

Color	L (mm)
Yellow	150
Green	150
Red	150
Black	150

CL No.	Part No.	RoHS
222-4473-8	TM1RV-623K64-4S-150M	YES

Color	L (mm)
Green	150
Red	150

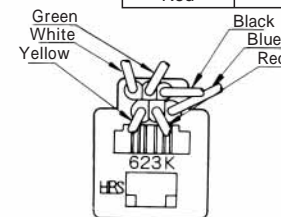
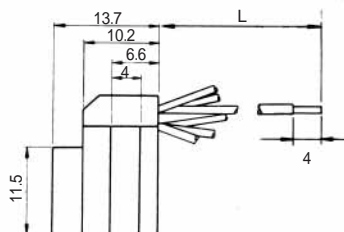
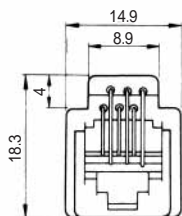

Note1: Standard finish color is gray.
 Note2: The drawing is shown sample of TM1RV-623K66- *

TM1RV-623P66- *
 TM1RV-623P64- *

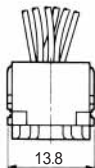
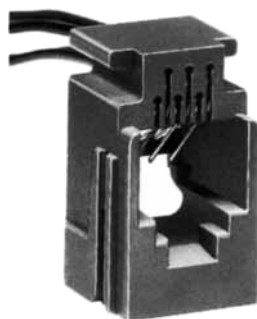

CL No.	Part No.	RoHS
222-4471-2	TM1RV-623P66-35S-150M	YES

Color	L (mm)
White	150
Black	150
Red	150
Green	150
Yellow	150
Blue	150

CL No.	Part No.	RoHS
222-4425-5	TM1RV-623P64-35S-150M	YES

Color	L (mm)
Black	150
Red	150
Green	150
Yellow	150

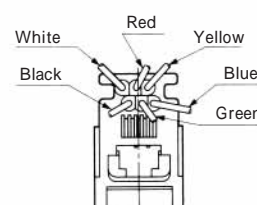
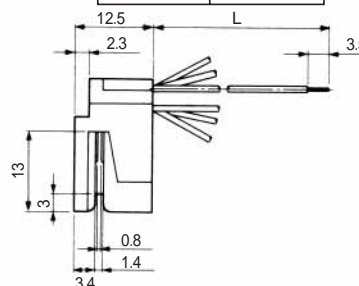
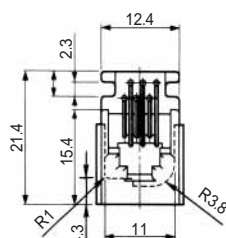

Note1: Standard finish color is gray.
 Note2: The drawing is shown sample of TM1RV-623P66- *

MODULAR CONNECTORS

CL 222 TM

●TM7RV-66-*

CL No.	Part No.	RoHS
222-4472-5	TM7RV-A66-35S-150M	YES

Color	L (mm)
White	150
Yellow	150
Green	150
Red	150
Black	150
Blue	150

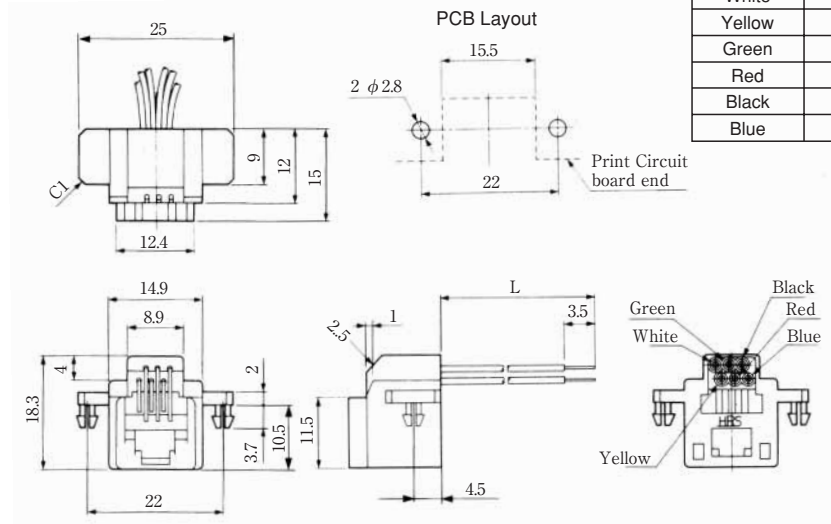
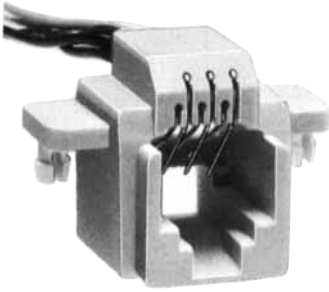

Note: Standard finish color is Vanilla white.

●TM2RGV-L66-*

●TM2RGV-L64-*

●TM2RGV-L62-*

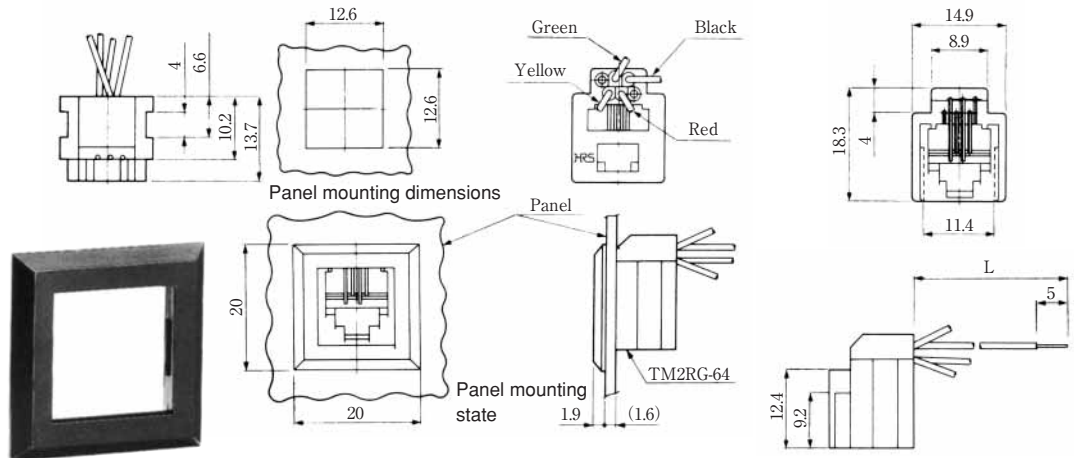

CL No.	Part No.	RoHS
222-4462-1	TM2RGV-L66-4S-150M	YES

Color	L (mm)
White	150
Yellow	150
Green	150
Red	150
Black	150
Blue	150

CL No.	Part No.	RoHS
222-4456-9	TM2RGV-L64-4S-150M	YES

Color	L (mm)
Yellow	150
Green	150
Red	150
Black	150

CL No.	Part No.	RoHS
222-4455-6	TM2RGV-L62-4S-150M	YES

Color	L (mm)
Green	150
Red	150

Note1: Standard finish color is dark brown. Note2: The drawing is shown sample of TM2RGV-L64-*

MODULAR CONNECTORS

CL 222 TM

TM1RV-647AF88- *

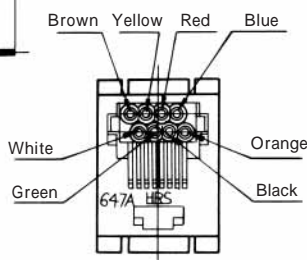
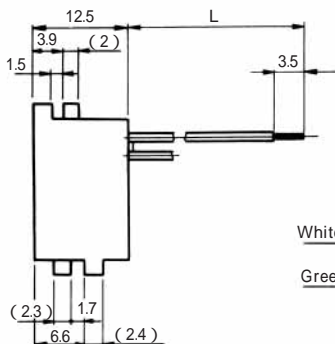
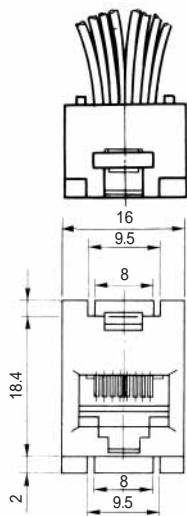

CL No.	Part No.	RoHS
222-4454-3	TM1RV647AF88-35S-150M	YES

Color	L (mm)
Brown	150
White	150
Yellow	150
Green	150
Red	150
Black	150
Blue	150
Orange	150

Note: Standard color is warm gray.

TM2RC-88- *

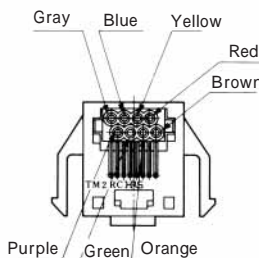
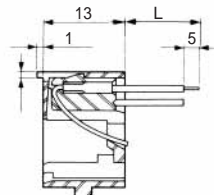
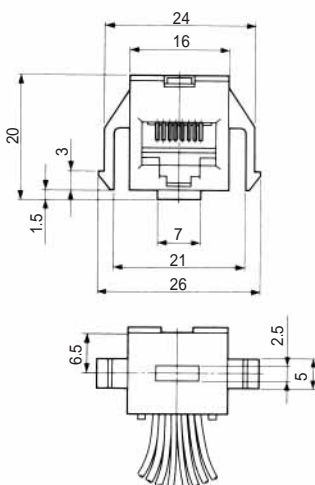
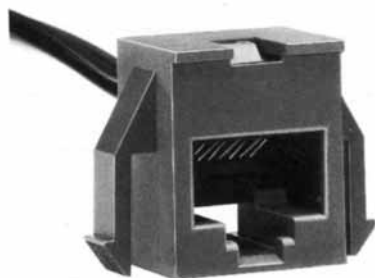

CL No.	Part No.	RoHS
222-4434-6	TM2RCV-M88-5S-450M	YES

Color	L (mm)
Gray	450
Purple	450
Blue	450
Green	450
Yellow	450
Orange	450
Red	450
Brown	450

Note: Standard finish color is beige white.



Компания «ЭлектроПласт» предлагает заключение долгосрочных отношений при поставках импортных электронных компонентов на взаимовыгодных условиях!

Наши преимущества:

- Оперативные поставки широкого спектра электронных компонентов отечественного и импортного производства напрямую от производителей и с крупнейших мировых складов;
- Поставка более 17-ти миллионов наименований электронных компонентов;
- Поставка сложных, дефицитных, либо снятых с производства позиций;
- Оперативные сроки поставки под заказ (от 5 рабочих дней);
- Экспресс доставка в любую точку России;
- Техническая поддержка проекта, помощь в подборе аналогов, поставка прототипов;
- Система менеджмента качества сертифицирована по Международному стандарту ISO 9001;
- Лицензия ФСБ на осуществление работ с использованием сведений, составляющих государственную тайну;
- Поставка специализированных компонентов (Xilinx, Altera, Analog Devices, Intersil, Interpoint, Microsemi, Aeroflex, Peregrine, Syfer, Eurofarad, Texas Instrument, Miteq, Cobham, E2V, MA-COM, Hittite, Mini-Circuits, General Dynamics и др.);

Помимо этого, одним из направлений компании «ЭлектроПласт» является направление «Источники питания». Мы предлагаем Вам помощь Конструкторского отдела:

- Подбор оптимального решения, техническое обоснование при выборе компонента;
- Подбор аналогов;
- Консультации по применению компонента;
- Поставка образцов и прототипов;
- Техническая поддержка проекта;
- Защита от снятия компонента с производства.



Как с нами связаться

Телефон: 8 (812) 309 58 32 (многоканальный)

Факс: 8 (812) 320-02-42

Электронная почта: org@eplast1.ru

Адрес: 198099, г. Санкт-Петербург, ул. Калинина, дом 2, корпус 4, литера А.