

Contact No. 208

New Brushed Chrome Cap and Bezel

Thin Flush Mount Pushbuttons
YB2 Panel Seal

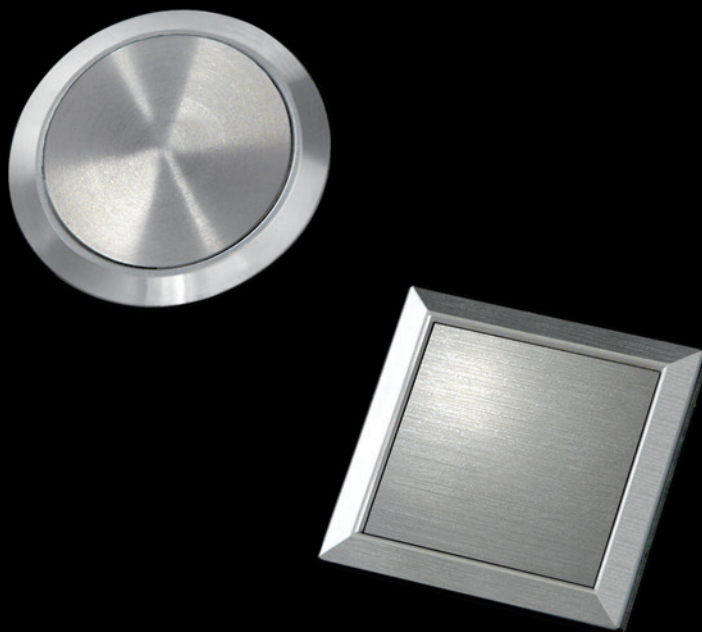

2012-09-18

NIKK
SWITCHES

General Specifications

Electrical Capacity (Resistive Load)

Power Level (silver):	3A @ 125V AC or 3A @ 250V AC or 3A @ 30V DC
Logic Level (gold):	0.4VA maximum @ 28V AC/DC maximum (Applicable Range 0.1mA ~ 0.1A @ 20mV ~ 28V)

Other Ratings

Contact Resistance:	50 milliohms maximum for silver; 100 milliohms maximum for gold
Insulation Resistance:	200 megohms minimum @ 500V DC
Dielectric Strength:	1,000V AC minimum between contacts for 1 minute minimum; 1,500V AC minimum between contacts & case for 1 minute minimum
Mechanical Life:	1,000,000 operations minimum for momentary circuit 200,000 operations minimum for maintained circuit
Electrical Life:	100,000 operations minimum
Nominal Operating Force:	Single pole: 1.5N Double pole: 3.0N
Contact Timing:	Nonshorting (break-before-make)
Travel:	Pretravel .059" (1.5mm); Overtravel .059" (1.5mm); Total Travel .118" (3.0mm) .098" (2.5mm) in Latchdown Position

Materials & Finishes

Bezel:	Black: Glass fiber reinforced polyamide (UL94V-0); Silver: Polycarbonate
Housing:	Glass fiber reinforced polyamide (UL94V-0)
Base:	Diallyl phthalate resin (UL94V-0)
Movable Contactor:	Phosphor bronze with silver or gold plating
Movable Contacts:	Phosphor bronze & silver alloy
Stationary Contacts:	Silver alloy or copper with gold plating
Switch Terminals:	Phosphor bronze with tin plating
Lamp Terminals:	Phosphor bronze with tin plating

Environmental Data

Operating Temperature Range:	-25°C through +50°C (-13°F through +122°F) for Illuminated -25°C through +70°C (-13°F through +158°F) for Nonilluminated
Humidity:	90 ~ 95% humidity for 96 hours @ 40°C (104°F)
Vibration:	10 ~ 55Hz with peak-to-peak amplitude of 1.5mm traversing the frequency range & returning in 1 minute; 3 right angled directions for 2 hours
Shock:	50G (490m/s ²) acceleration (tested in 6 right angled directions, with 5 shocks in each direction)
Sealing:	IP65 of IEC60529 standard

Installation

Mounting Torque:	0.785Nm (6.95 lb•in) maximum
Soldering Time & Temperature:	Manual Soldering: 390°C maximum for 4 seconds maximum

Standards & Certifications

Flammability Standards:	UL94V-0 housing, base & black or metallic silver bezel
UL:	File No. E44145 All solder lug models recognized at 3A @ 125/250V AC or 0.4VA @ 28V AC/DC maximum. Add "/CUL" to end of part number to order cULus mark on switch.

Distinctive Characteristics

- High quality brushed chrome cap and bezel options.
- Improved weather durability against ultraviolet rays.
- Meets IP65 of IEC60529 standards (similar to NEMA 4 and 13), providing dust tight and splashproof panel seal protection.
- Short body of .965" (24.5mm) conserves behind-panel space.
- Tamper resistant 19mm diameter actuator and 18mm square actuator.
- Shortest above-panel dimension (1.8mm) in the industry for splashproof design making panel flat and preventing operator error.
- Light weight compared to actual metal switches due to metal plating on resin.
- Distinctive long stroke and light touch actuation for smooth actuation and clear indication of circuit status.
- Choice of cap colors includes clear, red, green, amber, or brushed chrome for enhanced panel appearance.
- Metallic silver cap option has bright ring illumination (round only).
- Bezel color options in brushed chrome or black.
- Available in momentary and alternate action with latchdown.
- Crisp actuation and clear circuit status provided by snap-action contact mechanism. Arc barrier protects against crossover.
- Combination solder lug and .110" quick connect terminals. Terminals are epoxy sealed to lock out flux, dust, solvents, and other contaminants, as well as to secure terminals and improve contact stability.

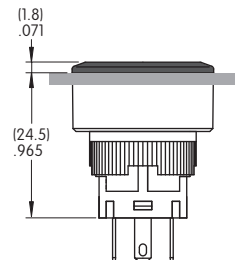

Brushed Chrome Bezel
+
Brushed Chrome Cap



Brushed Chrome Bezel
+
Ring Illuminated Metallic Silver Cap



Brushed Chrome Bezel
+
Illuminated Cap



Brushed Chrome Bezel
+
Brushed Chrome Plated Cap



Brushed Chrome Bezel
+
Illuminated Cap

TYPICAL SWITCH

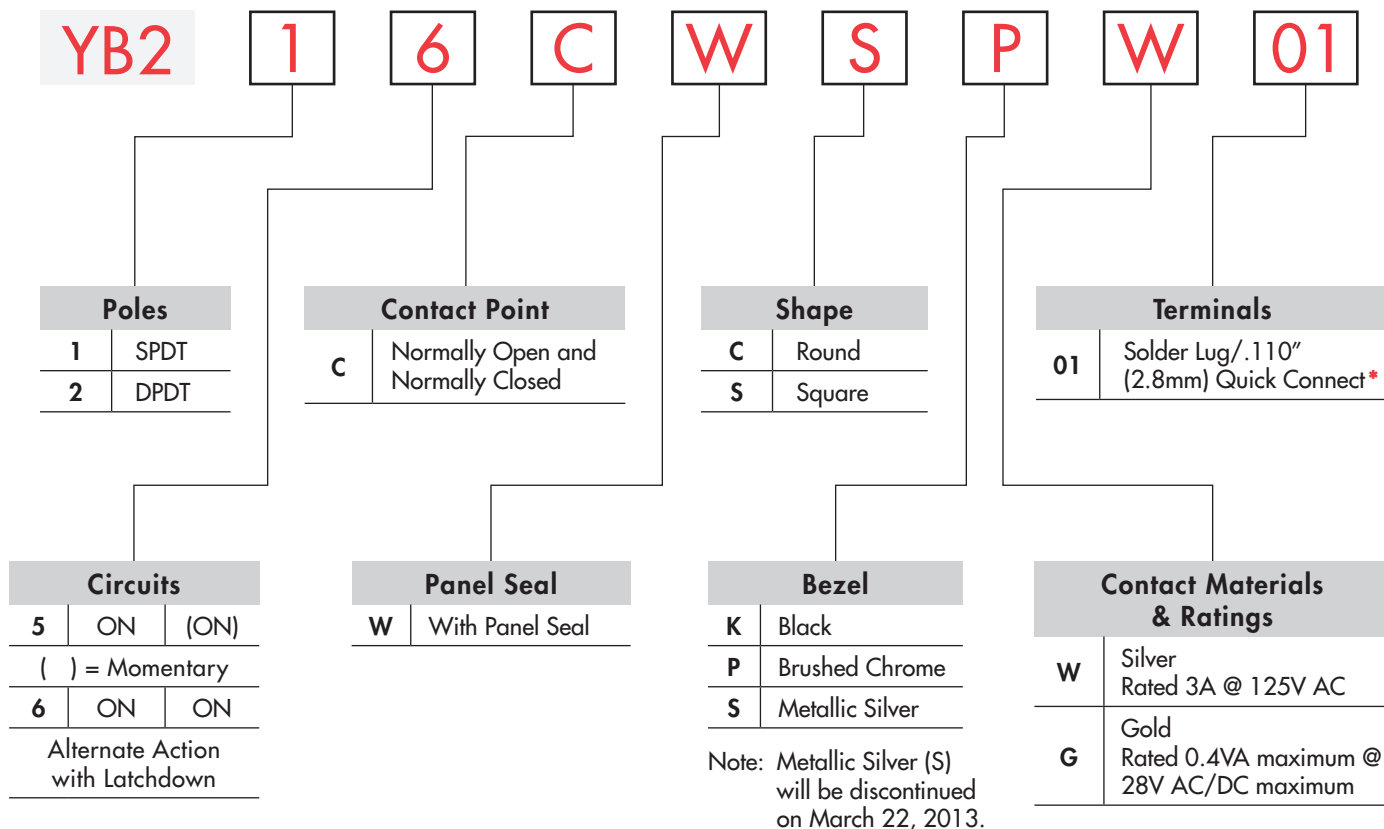

IMPORTANT:



Switches are supplied without cULus marking unless specified.
cULus recognized only when ordered with marking on the switch.
 Specific models, ratings, & ordering instructions are noted on General Specifications page.

* Wire harness & cable assemblies offered only in Americas

DESCRIPTION FOR TYPICAL ORDERING EXAMPLE

YB216CWSPW01-N-P

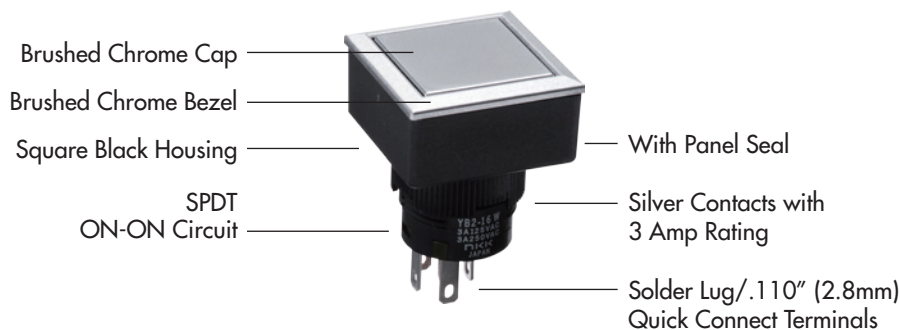

ORDERING EXAMPLE

N

P

LEDS

Cap Types & Colors

Bright LED				
LED Colors		Resistor		
5C	Red	No Code	No Resistor (not for Green)	
5D	Amber		05	5-volt
5F	Green		12	12-volt
		24	24-volt	

Lens/Diffuser Colors	
JB	Clear/White
JS	Metallic Silver Cap/Clear Ring (round only)
CB	Red/White
EB	Yellow/White
FB	Green/White

LED & cap need to be the same color.
 Yellow cap pairs with amber LED to achieve amber illumination. Codes JB & JS (round only) may be combined with all LED colors.

Super Bright LED	
6B	White
6F	Green
6G	Blue

Lens/Diffuser Cap Colors	
JB	Clear/White
JS	Metallic Silver Cap/Clear Ring (round only)

Nonilluminated	
N	No Lamp

Cap Color	
JB	Clear/White
CB	Red/White
EB	Yellow/White
FB	Green/White
P	Brushed Chrome
S	Metallic Silver

Note: Metallic Silver (S) will be discontinued on March 22, 013.

POLES & CIRCUITS

		Plunger Position () = Momentary		Connected Terminals		Throw & Switch/Lamp Schematics
Pole	Model	Normal	Down	Normal	Down	
SP	YB215 YB216	ON ON	(ON) ON	1-3	1-2	Notes: Switch is marked with NC, NO, COM, L+, L-. Lamp circuit is isolated and requires an external power source.
DP	YB225 YB226	ON ON	(ON) ON	1-3 4-6	1-2 4-5	

CONTACT POINT

C Normally Open and Normally Closed

Contact points are both Normally Open and Normally Closed.

PANEL SEAL

W Panel Seal (round and square)

Two o-rings provide panel seal protection meeting IP65 of IEC60529 standards.

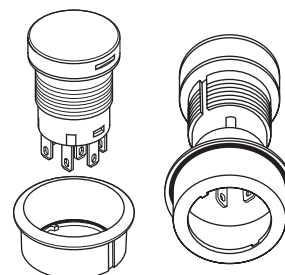

SHAPE

C Round

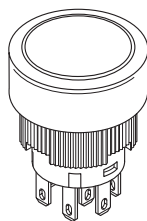

S Square

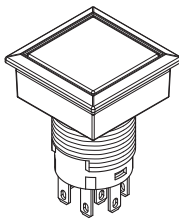

BEZEL

K Black

P Brushed Chrome

S Metallic Silver

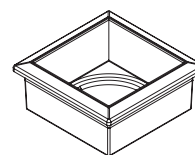
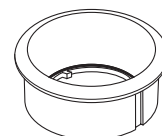

CONTACT MATERIALS & RATINGS

W Silver Contacts

Power Level: 3A @ 125/250V AC

Switch base is green

G Gold Contacts

Logic Level: 0.4VA max. @ 28V AC/DC max.

Switch base is red

TERMINALS

01 Solder Lug/
.110" (2.8mm) Quick Connect

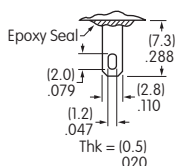

CAPS & CAP COLORS

AT3017 Cap for Bright LED

Lens/Diffuser Colors Available:

- JB** Clear/White
- CB** Red/White
- EB** *Yellow/White
- FB** Green/White

AT3018 Cap for Super Bright LED

Lens/Diffuser Colors Available:

- JB** Clear/White

AT3019 Cap for Nonilluminated

Cap Color Available:

- P** Brushed Chrome
- S** Metallic Silver

Note: AT3017 Cap can also be used without illumination.

AT3020 Cap with Illumination Ring for Bright or Super Bright LED

Cap Color Available:

- JS** Metallic Silver with Clear Ring

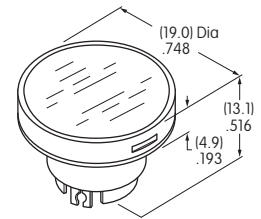
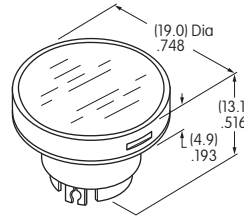
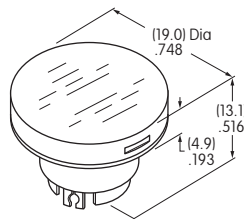
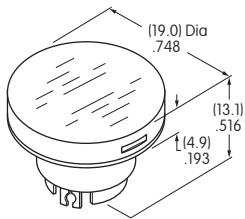

Material for Lens & Diffuser: Polycarbonate

Materials
Lens: Polycarbonate
Insert: Polyester

*Yellow cap pairs with amber LED to achieve amber illumination.

AT3025 Cap for Illuminated

Lens/Diffuser Colors Available:

- JB** Clear/White For Bright & Superbright LEDs
- CB** Red/White For Bright LED only
- EB** *Yellow/White For Bright LED only
- FB** Green/White For Bright LED only

AT3027 Cap for Nonilluminated

Cap Color Available:

- P** Brushed Chrome
- S** Metallic Silver

Note: AT3025 Cap can also be used without illumination.

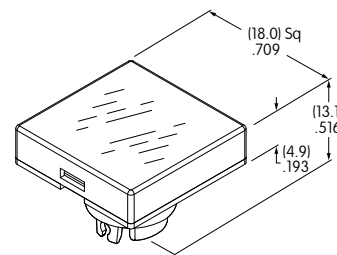
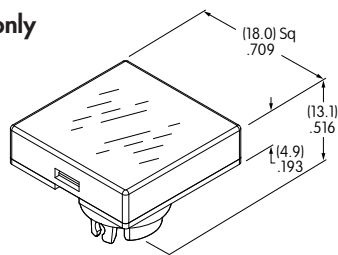

Material for Lens & Diffuser: Polycarbonate

*Yellow cap pairs with amber LED to achieve amber illumination.

TYPICAL SWITCH DIMENSIONS

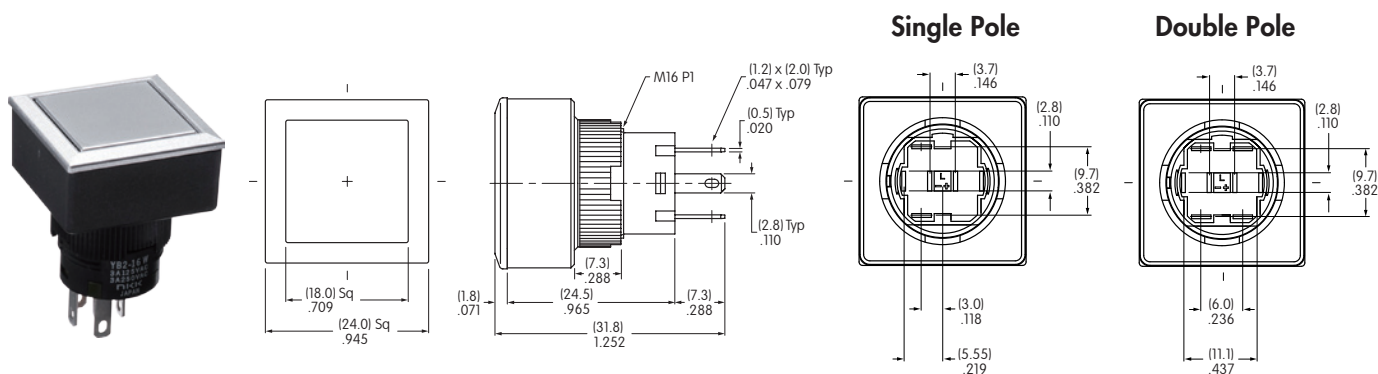

YB216CWSPW01-N-P

PANEL THICKNESS & CUTOUT

Panel Thickness
.020" ~ .197"
(0.5mm ~ 5.0mm)

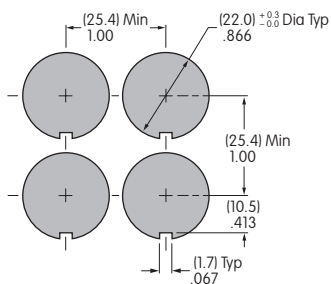

Side-by-side Mounting

Panel Thickness
.020" ~ .197"
(0.5mm ~ 5.0mm)

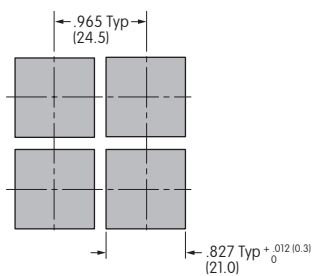

Side-by-side Mounting

Availability

October 22, 2012



Компания «ЭлектроПласт» предлагает заключение долгосрочных отношений при поставках импортных электронных компонентов на взаимовыгодных условиях!

Наши преимущества:

- Оперативные поставки широкого спектра электронных компонентов отечественного и импортного производства напрямую от производителей и с крупнейших мировых складов;
- Поставка более 17-ти миллионов наименований электронных компонентов;
- Поставка сложных, дефицитных, либо снятых с производства позиций;
- Оперативные сроки поставки под заказ (от 5 рабочих дней);
- Экспресс доставка в любую точку России;
- Техническая поддержка проекта, помощь в подборе аналогов, поставка прототипов;
- Система менеджмента качества сертифицирована по Международному стандарту ISO 9001;
- Лицензия ФСБ на осуществление работ с использованием сведений, составляющих государственную тайну;
- Поставка специализированных компонентов (Xilinx, Altera, Analog Devices, Intersil, Interpoint, Microsemi, Aeroflex, Peregrine, Syfer, Eurofarad, Texas Instrument, Miteq, Cobham, E2V, MA-COM, Hittite, Mini-Circuits, General Dynamics и др.);

Помимо этого, одним из направлений компании «ЭлектроПласт» является направление «Источники питания». Мы предлагаем Вам помощь Конструкторского отдела:

- Подбор оптимального решения, техническое обоснование при выборе компонента;
- Подбор аналогов;
- Консультации по применению компонента;
- Поставка образцов и прототипов;
- Техническая поддержка проекта;
- Защита от снятия компонента с производства.



Как с нами связаться

Телефон: 8 (812) 309 58 32 (многоканальный)

Факс: 8 (812) 320-02-42

Электронная почта: org@eplast1.ru

Адрес: 198099, г. Санкт-Петербург, ул. Калинина, дом 2, корпус 4, литера А.