

CERAFIL® (Filters/Traps/Discriminators) for Audio/Visual Equipment



EU RoHS Compliant

- All the products in this catalog comply with EU RoHS.
- EU RoHS is "the European Directive 2011/65/EU on the Restriction of the Use of Certain Hazardous Substances in Electrical and Electronic Equipment."
- For more details, please refer to our website 'Murata's Approach for EU RoHS' (<http://www.murata.com/info/rohs.html>).

CONTENTS

CERAFIL® and "CERAFIL" in this catalog are the trademarks of Murata Manufacturing Co., Ltd.

Part Numbering	2
1. CERAFIL®	
1-1 CERAFIL® 10.7MHz	
1 Small Chip Type SFECF Series	5
2 Chip Type SFECV/SFECK Series	11
3 Standard Lead Type SFELF Series	14
4 Low Loss Type SFELF Series	17
5 Low Spurious Response Type SFELF Series	20
6 Wide Bandwidth Type SFELF Series	23
7 Narrow Bandwidth Type SFELF Series	25
8 For FM-IF Tuners SFELF Series	27
Related Data on Lead Type	30
1-2 CERAFIL® 2.3-6.5MHz	
9 4.5-6.5MHz Chip Type SFSKA Series	31
10 2.3-5.7MHz Chip Type SFSKB Series	34
1-3 CERAFIL® 455kHz	
11 Chip Type SFPKA Series	38
12 Lead Type SFPLA/CFWLA Series	40
13 For AM Stereo Wide Bandwidth Type SFPLA/CFWLA/CFULA Series	42
SF□ Series Temperature Characteristics	44
2. Ceramic Trap	
14 Ceramic Trap 4.5-6.5MHz Chip Type TPSKA Series	45
3. Ceramic Discriminator	
15 10.7MHz Ultra Thin Chip Type CDSCB Series	47
Applied IC Reference Table	52
Notice	53
Packaging	69
Part Number Index	74

● Part Numbering

CERAFIL® for FM



① Product ID

Product ID	
SF	Ceramic Filters

② Oscillation/Number of Elements

Code	Oscillation/Number of Elements
E	2 Elements Thickness Expander mode
T	3 Elements Thickness Expander mode
V	2 Elements Thickness Expander mode (2nd Harmonic)
K	2 Elements Thickness Expander mode (3rd Overtone)

③ Structure/Size

Code	Structure/Size
L□	Lead Type
C□	Chip Type

□ is "A" or subsequent code, which indicates the structure/size.

④ Nominal Center Frequency

Expressed by four-digit alphanumerics. The unit is in hertz (Hz).
 Decimal point is expressed by capital letter "M" in case of MHz.

⑤ 3dB Bandwidth

Code	3dB Bandwidth
C	450kHz min
D	350kHz min
E	330kHz
F	280kHz
G	230kHz
H	180kHz
J	150kHz
K	110kHz
L	80kHz
M	50kHz
N	35kHz

⑥ Center Frequency/Tolerance

Code	Center Frequency	Tolerance
A	Center Frequency mentioned by specification	±30kHz
B	-30kHz shifted from center frequency of code "A"	±30kHz
C	+30kHz shifted from center frequency of code "A"	±30kHz
D	-60kHz shifted from center frequency of code "A"	±30kHz
E	+60kHz shifted from center frequency of code "A"	±30kHz
H	Center Frequency mentioned by specification	±25kHz
V	-50kHz shifted from center frequency of code "H"	±25kHz
W	+50kHz shifted from center frequency of code "H"	±25kHz
K	Center Frequency mentioned by specification	±20kHz
Z	Combination of A, B, C, D, E	—
M	Combination of A, B, C	—
F	Nominal Center Frequency	—

3dB bandwidth of "F" signifies the frequency difference (both + and -) from reference frequency, which is nominal center frequency.

⑦ Series

Code	Series
A0	Two-digit alphanumerics express series

⑧ Packaging

Code	Packaging
-B0	Bulk
-R0	Embossed Taping ø180mm
-R1	Embossed Taping ø330mm
-A0	1500pcs. /Radial Taping H ₀ =18mm
-A1	1000pcs. /Radial Taping H ₀ =18mm

Radial taping is applied to lead type and embossed taping to chip type.
 With non-standard products, two-digit alphanumerics indicating "Individual Specification" are added between "⑦Series" and "⑧Packaging."

CERAFIL®

(Part Number)

SF	S	KA	4M50	CF	00	-R1
①	②	③	④	⑤	⑥	⑦

① Product ID

Product ID	
SF	Ceramic Filters

② Oscillation/Numbers of Element

Code	Oscillation/Numbers of Element
S	2 Elements Thickness Shear mode

③ Structure/Size

Code	Structure/Size
K□	Chip Type

□ is "A" or subsequent code, which indicates the structure/size.

④ Nominal Center Frequency

Expressed by four-digit alphanumerics. The unit is in hertz (Hz).
 Decimal point is expressed by capital letter "M" in case of MHz.

⑤ Product Specification Code (1)

Code	Product Specification Code (1)
BF	Tight Bandwidth Type
CF	Standard Bandwidth Type
DF	Broad Bandwidth Type
EF	Ultra-broad Bandwidth Type

⑥ Product Specification Code (2)

Code	Product Specification Code (2)
00	Standard Type

⑦ Packaging

Code	Packaging
-B0	Bulk
-R1	Embossed Taping $\phi=330\text{mm}$

With non-standard products, two-digit alphanumerics indicating "Individual Specification" is added between "⑥ Product Specification Code (2)" and "⑦ Packaging."

CERAFIL® for AM

(Part Number)

SF	P	KA	455K	D4A	-B0
①	②	③	④	⑤	⑥

① Product ID

Product ID	
SF	Ceramic Filters
CF	Ceramic Filters

② Oscillation/Numbers of Element

Code	Oscillation/Numbers of Element
P	4 Elements Area Expansion mode

③ Structure/Size

Code	Structure/Size
L□	Lead Type
C□/K□	Chip Type

□ is "A" or subsequent code, which indicates the structure/size. It varies depending on vibration mode and number of elements.

④ Nominal Center Frequency

Expressed by four-digit alphanumerics. The unit is in hertz (Hz).
 Capital letter "K" following three figures expresses the unit of "kHz."

⑤ Product Specification

Code	Product Specification
D4A	Three-digit alphanumerics indicate product specification of 3dB or 6dB frequency tolerance.

□□A indicates standard type.

⑥ Packaging

Code	Packaging
-B0	Bulk
-R0	Embossed Taping ($\phi 180\text{mm}$)
-R1	Embossed Taping ($\phi 330\text{mm}$)
-M0	Magazine Cassette

Radial taping is applied to lead type and embossed taping to chip type.
 With non-standard products, three-digit alphanumerics indicating "Individual Specification" is added between "⑤ Product Specification" and "⑥ Packaging."

Ceramic Traps

(Part Number)

TP	S	KA	4M00	B	00	-R0
①	②	③	④	⑤	⑥	⑦

① Product ID

Product ID	
TP	Ceramic Traps

② Function

Code	Function
S	Single Traps

③ Structure/Size

Code	Structure/Size
K□	Chip Type

□ is "A" or subsequent code, which indicates the structure/size.

④ Nominal Center Frequency

Expressed by four-digit alphanumerics. The unit is in hertz (Hz).
 Decimal point is expressed by capital letter "M" in case of MHz.

Discriminators for FM

(Part Number)

CD	A	LF	10M7	G	A	001	-B0
①	②	③	④	⑤	⑥	⑦	⑧

① Product ID

Product ID	
CD	Discriminators

② Oscillation

Code	Oscillation
A	Thickness Expander mode
S	Thickness Shear mode

③ Structure/Size

Code	Structure/Size
L□	Lead Type
C□	Chip Type

□ is "A" or subsequent code, which indicates the structure/size.

④ Nominal Center Frequency

Expressed by four-digit alphanumerics. The unit is in hertz (Hz).
 Decimal point is expressed by capital letter "M" in case of MHz.

⑤ Series

Code	Series
G	Two-digit alphanumerics express series

⑤ Product Specification Code (1)

Code	Product Specification (1)
B	Broad bandwidth Type
C	Low capacitance Type

⑥ Product Specification Code (2)

Code	Product Specification (2)
00	Standard Type

⑦ Packaging

Code	Packaging
-B0	Bulk
-R1	Embossed Taping $\phi=330\text{mm}$

With non-standard products, three-digit alphanumerics indicating "Individual Specification" is added between "⑥ Product Specification Code (2)" and "⑦ Packaging."

⑥ Center Frequency/Tolerance

Code	Center Frequency	Tolerance
A	Center Frequency mentioned by specification	$\pm 30\text{kHz}$
B	-30kHz shifted from center frequency of code "A"	$\pm 30\text{kHz}$
C	+30kHz shifted from center frequency of code "A"	$\pm 30\text{kHz}$
D	-60kHz shifted from center frequency of code "A"	$\pm 30\text{kHz}$
E	+60kHz shifted from center frequency of code "A"	$\pm 30\text{kHz}$
H	Center Frequency mentioned by specification	$\pm 25\text{kHz}$
V	-50kHz shifted from center frequency of code "H"	$\pm 25\text{kHz}$
W	+50kHz shifted from center frequency of code "H"	$\pm 25\text{kHz}$
K	Center Frequency mentioned by specification	$\pm 20\text{kHz}$
Z	Combination of A, B, C, D, E	—
M	Combination of A, B, C	—
F	Nominal Center Frequency	—

3dB bandwidth of "F" signifies the frequency difference (both + and -) from reference frequency, which is nominal center frequency.

⑦ IC

Code	IC
001	Applicable IC Control Code

⑧ Packaging

Code	Packaging
-B0	Bulk
-A0	Radial Taping $H_0=18\text{mm}$
-R0	Embossed Taping $\phi=180\text{mm}$
-R1	Embossed Taping $\phi=330\text{mm}$

Radial taping is applied to lead type and embossed taping to chip type.
 With non-standard products, an alphanumerics indicating "Individual Specification" is added between "⑦ IC" and "⑧ Packaging."

CERAFIL® (CERAFIL® 10.7MHz) for Audio/Visual Equipment



Small Chip Type SFECF Series

SFECF10M7 series for FM receivers are small, high-performance and super thin (1.4mm max.) filters. The piezoelectric element is sandwiched by the ceramic substrate. They have 1.4mm max. thickness and a small mounting area (3.45x3.1mm). SFECF series and CDSCB series (MHz Discriminator) enable customers to make VICS/RKE/TPMS set very thin and small.

■ Features

1. The filters are mountable by automatic placers.
2. They are slim, at only 1.4mm max. thickness, and have a small mounting area (3.45x3.1mm) enabling flexible PCB design.
3. Various bandwidths are available. Select a suitable type in accordance with the desired selectivity.
4. Operating Temperature Range:
 - 20 to +80°C (Standard Type)
 - 40 to +85°C (High-reliability Type)
 Storage Temperature Range:
 - 40 to +85°C (Standard Type)
 - 55 to +85°C (High-reliability Type)



Standard Type

Part Number	Center Frequency (fo) (MHz)	Nominal Center Frequency (fn) (MHz)	3dB Bandwidth (kHz)	Attenuation (kHz)	Insertion Loss (dB)	Ripple (dB)	Spurious Attenuation (1) (dB)	Spurious Attenuation (2) (dB)	Input/Output Impedance (ohm)
SFECF10M7HA00-R0	10.700 ±30kHz	-	180 ±40kHz	470 max.	4.0±2.0dB	1.0 max.	30 min. [within 9MHz to fo]	30 min. [within fo to 12MHz]	330
SFECF10M7HF00-R0	-	10.700	fn±25 min.	510 max.	8.0max. [at fn]	1.0 max.	30 min. [within 9MHz to fn]	25 min. [within fn to 12MHz]	330
SFECF10M7GA00-R0	10.700 ±30kHz	-	230 ±50kHz	510 max.	3.5±2.0dB	1.0 max.	30 min. [within 9MHz to fo]	30 min. [within fo to 12MHz]	330
SFECF10M7GF00-R0	-	10.700	fn±45 min.	560 max.	8.0max. [at fn]	1.0 max.	30 min. [within 9MHz to fn]	25 min. [within fn to 12MHz]	330
SFECF10M7FA00-R0	10.700 ±30kHz	-	280 ±50kHz	590 max.	3.0±2.0dB	1.0 max.	30 min. [within 9MHz to fo]	30 min. [within fo to 12MHz]	330
SFECF10M7FF00-R0	-	10.700	fn±65 min.	620 max.	7.0max. [at fn]	1.0 max.	30 min. [within 9MHz to fn]	25 min. [within fn to 12MHz]	330
SFECF10M7EA00-R0	10.700 ±30kHz	-	330 ±50kHz	700 max.	3.0±2.0dB	1.0 max.	30 min. [within 9MHz to fo]	30 min. [within fo to 12MHz]	330
SFECF10M7DA0001-R0	10.700 ±30kHz	-	420 min.	950 max.	3.0±2.0dB	3.0 max.	35 min. [within 9MHz to fo]	25 min. [within fo to 12MHz]	330
SFECF10M7DF00-R0	-	10.700	fn±150 min.	990 max.	6.0max. [at fn]	3.0 max.	20 min. [within 9MHz to fn]	20 min. [within fn to 12MHz]	330

Area of Attenuation: [within 20dB]

Area of Insertion Loss: at minimum loss point Area of Ripple: within 3dB B.W.

Center frequency (fo) defined by the center of 3dB bandwidth.

For safety purposes, connect the output of filters to the IF amplifier through a D.C. blocking capacitor. Avoid applying a direct current to the output of ceramic filters.

The order quantity should be an integral multiple of the "Minimum Quantity" shown in the package page.

High-Reliability Type

Part Number	Center Frequency (fo) (MHz)	Nominal Center Frequency (fn) (MHz)	3dB Bandwidth (kHz)	Attenuation (kHz)	Insertion Loss (dB)	Ripple (dB)	Spurious Attenuation (1) (dB)	Spurious Attenuation (2) (dB)	Input/Output Impedance (ohm)
SFECF10M7HA00S0-R0	10.700 ±30kHz	-	180 ±40kHz	470 max.	4.0±2.0dB	1.0 max.	30 min. [within 9MHz to fo]	30 min. [within fo to 12MHz]	330
SFECF10M7HF00S0-R0	-	10.700	fn±25 min.	510 max.	8.0max. [at fn]	1.0 max.	30 min. [within 9MHz to fn]	25 min. [within fn to 12MHz]	330
SFECF10M7GA00S0-R0	10.700 ±30kHz	-	230 ±50kHz	510 max.	3.5±2.0dB	1.0 max.	30 min. [within 9MHz to fo]	30 min. [within fo to 12MHz]	330
SFECF10M7GF00S0-R0	-	10.700	fn±45 min.	560 max.	8.0max. [at fn]	1.0 max.	30 min. [within 9MHz to fn]	25 min. [within fn to 12MHz]	330
SFECF10M7FA00S0-R0	10.700 ±30kHz	-	280 ±50kHz	590 max.	3.0±2.0dB	1.0 max.	30 min. [within 9MHz to fo]	30 min. [within fo to 12MHz]	330
SFECF10M7FF00S0-R0	-	10.700	fn±65 min.	630 max.	7.0max. [at fn]	1.0 max.	30 min. [within 9MHz to fn]	25 min. [within fn to 12MHz]	330
SFECF10M7EA00S0-R0	10.700 ±30kHz	-	330 ±50kHz	700 max.	3.0±2.0dB	1.0 max.	30 min. [within 9MHz to fo]	30 min. [within fo to 12MHz]	330
SFECF10M7DF00S0-R0	-	10.700	fn±145 min.	990 max.	6.0max. [at fn]	3.0 max.	20 min. [within 9MHz to fn]	20 min. [within fn to 12MHz]	330

Area of Attenuation: [within 20dB]

Area of Insertion Loss: at minimum loss point Area of Ripple: within 3dB B.W.

Center frequency (fo) defined by the center of 3dB bandwidth.

For safety purposes, connect the output of filters to the IF amplifier through a D.C. blocking capacitor. Avoid applying a direct current to the output of ceramic filters.

The order quantity should be an integral multiple of the "Minimum Quantity" shown in the package page.

Standard Center Frequency Rank Code

CODE	30kHz Step	25kHz Step
D	10.64MHz±30kHz	10.650MHz±25kHz
B	10.67MHz±30kHz	10.675MHz±25kHz
A	10.70MHz±30kHz	10.700MHz±25kHz
C	10.73MHz±30kHz	10.725MHz±25kHz
E	10.76MHz±30kHz	10.750MHz±25kHz
Z	Combination A, B, C, D, E	
M	Combination A, B, C	

Standard Land Pattern Dimensions



Test Circuit

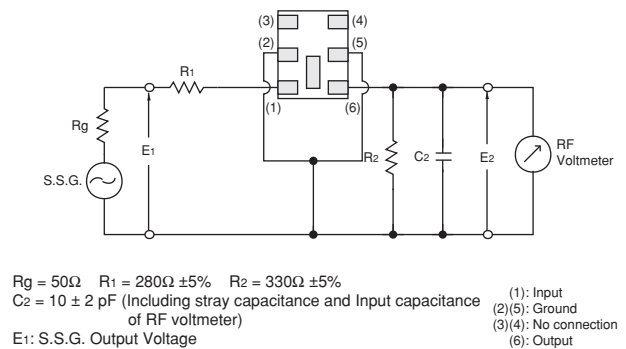

■ Frequency Characteristics Standard Type

SFECF10M7HA00-R0/SFECF10M7HF00-R0



SFECF10M7GA00-R0/SFECF10M7GF00-R0



SFECF10M7FA00-R0/SFECF10M7FF00-R0



SFECF10M7EA00-R0



SFECF10M7DA0001-R0



SFECF10M7DF00-R0



Frequency Characteristics High-reliability Type

SFECF10M7HA00S0-R0/SFECF10M7HF00S0-R0



SFECF10M7GA00S0-R0/SFECF10M7GF00S0-R0



SFECF10M7FA00S0-R0/SFECF10M7FF00S0-R0



SFECF10M7EA00S0-R0

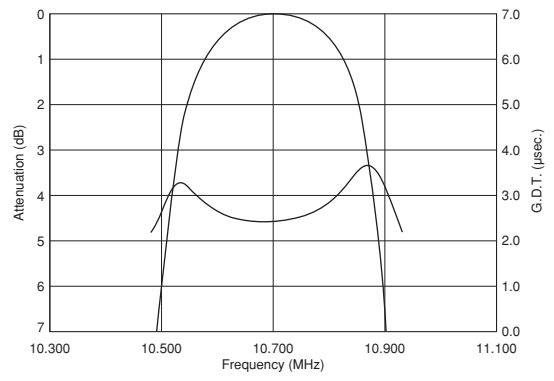

SFECF10M7DF00S0-R0



■ Frequency Characteristics (Spurious) Standard Type

SFECF10M7HA00-R0/SFECF10M7HF00-R0



SFECF10M7GA00-R0/SFECF10M7GF00-R0



SFECF10M7FA00-R0/SFECF10M7FF00-R0



SFECF10M7EA00-R0



SFECF10M7DA0001-R0/SFECF10M7DF00-R0



■ Frequency Characteristics (Spurious) High-reliability Type

SFECF10M7HA00S0-R0/SFECF10M7HF00S0-R0



SFECF10M7GA00S0-R0/SFECF10M7GF00S0-R0



SFECF10M7FA00S0-R0/SFECF10M7FF00S0-R0



SFECF10M7EA00S0-R0



SFECF10M7DF00S0-R0



CERAFIL® (CERAFIL® 10.7MHz) for Audio/Visual Equipment



Chip Type SFECV/SFECK Series

SFECV/SFECK10M7 series for FM receivers are monolithic type ceramic filters that utilize the thickness expander mode of piezoelectric ceramics. SFECV series enable customers to make an AM/FM set very thin, and it can be useful to the total chip circuit.

■ Features

1. The piezoelectric element is sandwiched by heat resistant substrate, thus it has excellent mechanical strength, and it is suitable for automatic mounting.
2. Various bandwidths are available. Select a suitable type in accordance with the desired selectivity.
3. Operating Temperature Range:
 - 20 to +80°C (Standard Type)
 - 40 to +85°C (High-reliability Type)
 Storage Temperature Range:
 - 40 to +85°C (Standard Type)
 - 55 to +85°C (High-reliability Type)

■ Applications

1. Small, thin radios
2. Automotive radios
3. Headphone stereos



Standard Type

Part Number	Center Frequency (fo) (MHz)	3dB Bandwidth (kHz)	Attenuation (kHz)	Insertion Loss (dB)	Ripple (dB)	Spurious Attenuation (1) (dB)	Spurious Attenuation (2) (dB)	Input/Output Impedance (ohm)
SFECV15M0EQ0001-R0	15.000 ±50kHz	300 min.	750 max.	7.0max.	1.0 max.	30 min. [within 14MHz to fo]	30 min. [within fo to 16MHz]	330
SFECV10M7KA00-R0	10.700 ±30kHz	110 ±30kHz	320 max.	6.0±2.0dB	1.0 max.	35 min. [within 9MHz to fo]	35 min. [within fo to 12MHz]	330
SFECV10M7JA00-R0	10.700 ±30kHz	150 ±40kHz	380 max.	5.5±2.0dB	1.0 max.	35 min. [within 9MHz to fo]	35 min. [within fo to 12MHz]	330

Area of Attenuation: [within 20dB]

Area of Insertion Loss: at minimum loss point

Center frequency (fo) defined by the center of 3dB bandwidth.

For safety purposes, connect the output of filters to the IF amplifier through a D.C. blocking capacitor. Avoid applying a direct current to the output of ceramic filters.

The order quantity should be an integral multiple of the "Minimum Quantity" shown in the package page.

High-Reliability Type

Part Number	Center Frequency (fo) (MHz)	3dB Bandwidth (kHz)	Attenuation (kHz)	Insertion Loss (dB)	Ripple (dB)	Spurious Attenuation (1) (dB)	Spurious Attenuation (2) (dB)	Input/Output Impedance (ohm)
SFECK10M7KA00S0-R0	10.700 ±30kHz	110 ±30kHz	320 max.	6.0±2.0dB	1.0 max.	35 min. [within 9MHz to fo]	35 min. [within fo to 12MHz]	330
SFECK10M7JA00S0-R0	10.700 ±30kHz	150 ±40kHz	380 max.	5.5±2.0dB	1.0 max.	35 min. [within 9MHz to fo]	35 min. [within fo to 12MHz]	330

Area of Attenuation: [within 20dB]

Area of Insertion Loss: at minimum loss point

Center frequency (fo) defined by the center of 3dB bandwidth.

For safety purposes, connect the output of filters to the IF amplifier through a D.C. blocking capacitor. Avoid applying a direct current to the output of ceramic filters.

The order quantity should be an integral multiple of the "Minimum Quantity" shown in the package page.

2

Standard Center Frequency Rank Code

CODE	30kHz Step	25kHz Step
D	10.64MHz±30kHz	10.650MHz±25kHz
B	10.67MHz±30kHz	10.675MHz±25kHz
A	10.70MHz±30kHz	10.700MHz±25kHz
C	10.73MHz±30kHz	10.725MHz±25kHz
E	10.76MHz±30kHz	10.750MHz±25kHz
Z	Combination A, B, C, D, E	
M	Combination A, B, C	

Standard Land Pattern Dimensions



Test Circuit



$R_g = 50\Omega$ $R_1 = 280\Omega \pm 5\%$ $R_2 = 330\Omega \pm 5\%$
 $C_2 = 10 \pm 2 \text{ pF}$ (Including stray capacitance and Input capacitance of RF voltmeter)
 E1 : S.S.G. Output Voltage
 (1) : Input
 (2) : Ground
 (3) : Output

Frequency Characteristics Standard Type



■ Frequency Characteristics High-reliability Type



■ Frequency Characteristics (Spurious) Standard Type



■ Frequency Characteristics (Spurious) High-reliability Type

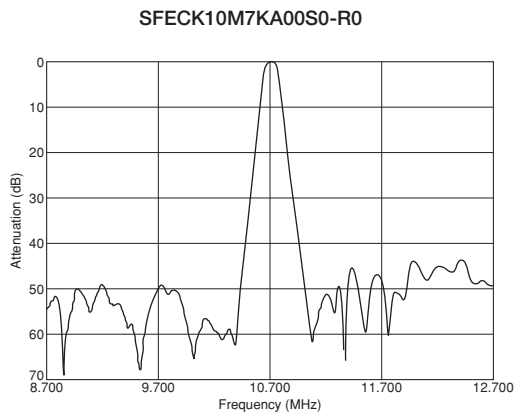

CERAFIL® (CERAFIL® 10.7MHz) for Audio/Visual Equipment



Standard Lead Type SFELF Series

3

SFELF10M7 series for FM-receivers are monolithic type ceramic filters that use the thickness expander mode of the piezoelectric ceramic.

As part of the environment protection program, the solder for terminal plating and terminal-element connection inside of the ceramic filter contain no lead (Pb).

■ Features

1. These miniature filters have high mechanical strength.
2. Low loss, favorable waveform symmetry, and high selectivity
3. Various bandwidths are available for applications in wide to narrow bands.
4. Small dispersion and stable characteristics
5. Change in center frequency is typically within $\pm 30\text{ppm}/^\circ\text{C}$ at -20 to $+80^\circ\text{C}$.
6. High reliability



SFELF10M7HA00-B0



SFELF10M7GA00-B0



SFELF10M7FA00-B0



Part Number	Center Frequency (fo) (MHz)	3dB Bandwidth (kHz)	Attenuation (kHz)	Insertion Loss (dB)	Spurious Attenuation (1) (dB)	Spurious Attenuation (2) (dB)	Input/Output Impedance (ohm)
SFELF10M7HA00-B0	10.700 $\pm 30\text{kHz}$	180 $\pm 40\text{kHz}$	520 max.	7.0max.	40 min. [within 9MHz to fo]	40 min. [within fo to 12MHz]	330
SFELF10M7GA00-B0	10.700 $\pm 30\text{kHz}$	230 $\pm 50\text{kHz}$	570 max.	4.0 $\pm 2.0\text{dB}$	40 min. [within 9MHz to fo]	40 min. [within fo to 12MHz]	330
SFELF10M7FA00-B0	10.700 $\pm 30\text{kHz}$	280 $\pm 50\text{kHz}$	650 max.	4.0 $\pm 2.0\text{dB}$	30 min. [within 9MHz to fo]	30 min. [within fo to 12MHz]	330

Area of Attenuation: [within 20dB]

Area of Insertion Loss: at minimum loss point

Center frequency (fo) defined by the center of 3dB bandwidth.

For safety purposes, connect the output of filters to the IF amplifier through a D.C. blocking capacitor. Avoid applying a direct current to the output of ceramic filters.

The order quantity should be an integral multiple of the "Minimum Quantity" shown in the package page.

Standard Center Frequency Rank Code

CODE	30kHz Step	25kHz Step	Color Code
D	10.64MHz±30kHz	10.650MHz±25kHz	Black
B	10.67MHz±30kHz	10.675MHz±25kHz	Blue
A	10.70MHz±30kHz	10.700MHz±25kHz	Red
C	10.73MHz±30kHz	10.725MHz±25kHz	Orange
E	10.76MHz±30kHz	10.750MHz±25kHz	White
Z	Combination A, B, C, D, E		
M	Combination A, B, C		

Test Circuit

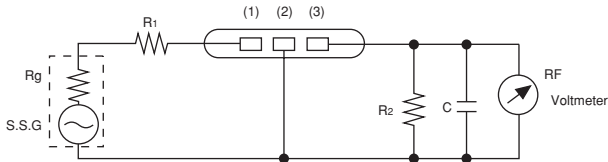

$R_g + R_1 = R_2 =$ Input and Output Impedance
 $C = 10\text{pF}$ (Including stray capacitance and input capacitance of RF voltmeter.)

(1) : Input
 (2) : Ground
 (3) : Output

Frequency Characteristics

SFELF10M7HA00-B0



SFELF10M7GA00-B0



SFELF10M7FA00-B0

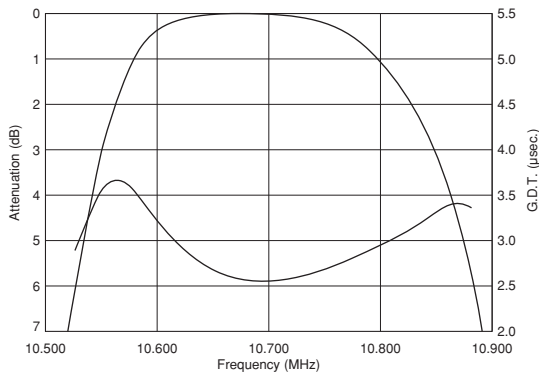

■ Frequency Characteristics (Spurious)

SFELF10M7HA00-B0

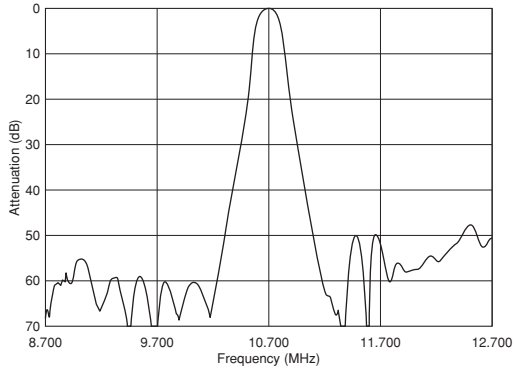

SFELF10M7GA00-B0

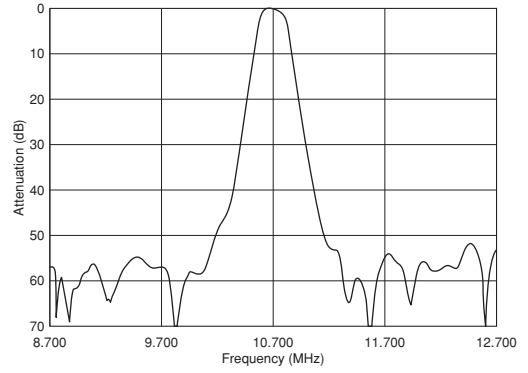

SFELF10M7FA00-B0

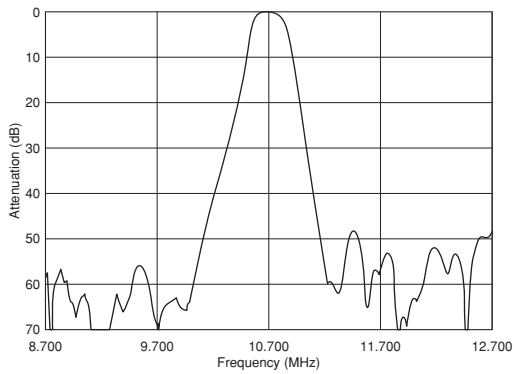

3

CERAFIL® (CERAFIL® 10.7MHz) for Audio/Visual Equipment



Low Loss Type SFELF Series

SFELF10M7 series for FM receivers are monolithic type ceramic filters that use the thickness expander mode of the piezoelectric ceramic.

As part of the environment protection program, the solder for terminal plating and terminal-element connection inside of the ceramic filter contain no lead (Pb).

■ Features

1. Insertion loss is 1 to 1.5dB lower than conventional products. These types are useful for elevating the sensitivity of sets.
2. Small dispersion and stable characteristics
3. Excellent shape factor of frequency response
4. Good waveform symmetry



SFELF10M7JAA0-B0



SFELF10M7HAA0-B0

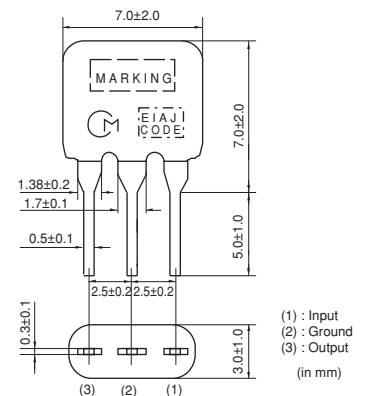

SFELF10M7GAA0-B0



SFELF10M7FAA0-B0



Part Number	Center Frequency (fo) (MHz)	3dB Bandwidth (kHz)	Attenuation (kHz)	Insertion Loss (dB)	Spurious Attenuation (1) (dB)	Spurious Attenuation (2) (dB)	Input/Output Impedance (ohm)
SFELF10M7JAA0-B0	10.700 ±30kHz	150 ±40kHz	360 max.	4.5±2.0dB	35 min. [within 9MHz to fo]	35 min. [within fo to 12MHz]	330
SFELF10M7HAA0-B0	10.700 ±30kHz	180 ±40kHz	470 max.	3.5±1.5dB	35 min. [within 9MHz to fo]	35 min. [within fo to 12MHz]	330
SFELF10M7GAA0-B0	10.700 ±30kHz	230 ±50kHz	520 max.	3.0±2.0dB	35 min. [within 9MHz to fo]	35 min. [within fo to 12MHz]	330
SFELF10M7FAA0-B0	10.700 ±30kHz	280 ±50kHz	590 max.	2.5±2.0dB	30 min. [within 9MHz to fo]	30 min. [within fo to 12MHz]	330

Area of Attenuation: [within 20dB]

Area of Insertion Loss: at minimum loss point

Center frequency (fo) defined by the center of 3dB bandwidth.

For safety purposes, connect the output of filters to the IF amplifier through a D.C. blocking capacitor. Avoid applying a direct current to the output of ceramic filters.

The order quantity should be an integral multiple of the "Minimum Quantity" shown in the package page.

Standard Center Frequency Rank Code

CODE	30kHz Step	25kHz Step	Color Code
D	10.64MHz±30kHz	10.650MHz±25kHz	Black
B	10.67MHz±30kHz	10.675MHz±25kHz	Blue
A	10.70MHz±30kHz	10.700MHz±25kHz	Red
C	10.73MHz±30kHz	10.725MHz±25kHz	Orange
E	10.76MHz±30kHz	10.750MHz±25kHz	White
Z	Combination A, B, C, D, E		
M	Combination A, B, C		

Test Circuit

4



$R_g + R_1 = R_2 =$ Input and Output Impedance
 $C = 10\text{pF}$ (Including stray capacitance and input capacitance of RF voltmeter.)

(1) : Input
 (2) : Ground
 (3) : Output

Frequency Characteristics

SFELF10M7JAA0-B0



SFELF10M7HAA0-B0



SFELF10M7GAA0-B0



SFELF10M7FAA0-B0



■ Frequency Characteristics (Spurious)

SFELF10M7JAA0-B0



SFELF10M7HAA0-B0



SFELF10M7GAA0-B0



SFELF10M7FAA0-B0



4

CERAFIL® (CERAFIL® 10.7MHz) for Audio/Visual Equipment



Low Spurious Response Type SFELF Series

SFELF10M7 series for FM-receivers are monolithic type ceramic filters that use the thickness expander mode of the piezoelectric ceramic.

As part of the environment protection program, the solder for terminal plating and terminal-element connection inside of the ceramic filter contain no lead (Pb).

■ Features

These types have lower spurious response compared to standard filters.

5



SFELF10M7KAB0-B0



SFELF10M7JAB0-B0

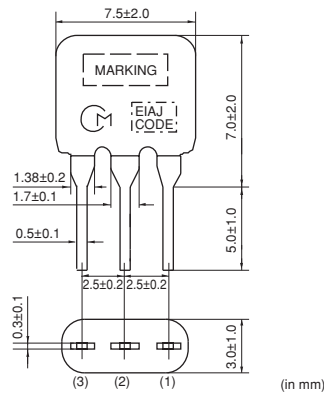

SFELF10M7HAB0-B0

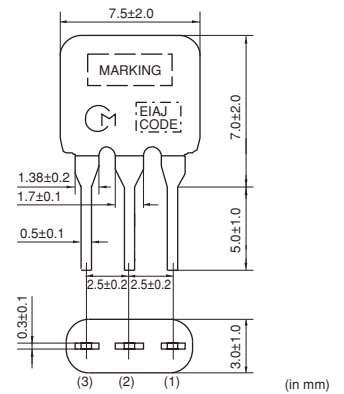

SFELF10M7GAB0-B0

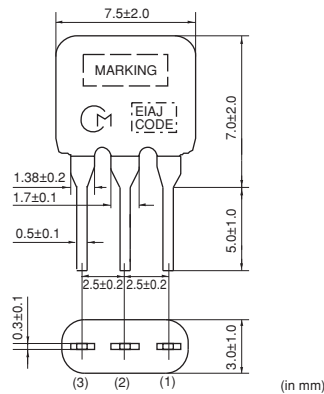

SFELF10M7FAB0-B0

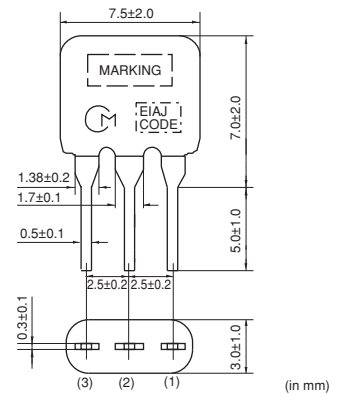

Part Number	Center Frequency (fo) (MHz)	3dB Bandwidth (kHz)	Attenuation (kHz)	Insertion Loss (dB)	Spurious Attenuation (1) (dB)	Spurious Attenuation (2) (dB)	Input/Output Impedance (ohm)
SFELF10M7KAB0-B0	10.700 ±30kHz	110 ±30kHz	350 max.	7.0±2.0dB	45/30 min. [within 9MHz to fo]	30 min. [within fo to 12MHz]	330
SFELF10M7JAB0-B0	10.700 ±30kHz	150 ±40kHz	380 max.	5.5±2.0dB	45 min. [within 9MHz to fo]	45 min. [within fo to 12MHz]	330
SFELF10M7HAB0-B0	10.700 ±30kHz	180 ±40kHz	520 max.	5.0±2.0dB	45 min. [within 9MHz to fo]	45 min. [within fo to 12MHz]	330
SFELF10M7GAB0-B0	10.700 ±30kHz	230 ±50kHz	570 max.	3.0±2.0dB	45 min. [within 9MHz to fo]	45 min. [within fo to 12MHz]	330

Continued on the following page. ↗

Continued from the preceding page.

Part Number	Center Frequency (fo) (MHz)	3dB Bandwidth (kHz)	Attenuation (kHz)	Insertion Loss (dB)	Spurious Attenuation (1) (dB)	Spurious Attenuation (2) (dB)	Input/Output Impedance (ohm)
SFELF10M7FAB0-B0	10.700 ±30kHz	280 ±50kHz	650 max.	3.0±2.0dB	45 min. [within 9MHz to fo]	45 min. [within fo to 12MHz]	330

Area of Attenuation: [within 20dB]

Area of Insertion Loss: at minimum loss point

Center frequency (fo) defined by the center of 3dB bandwidth.

For safety purposes, connect the output of filters to the IF amplifier through a D.C. blocking capacitor. Avoid applying a direct current to the output of ceramic filters.

The order quantity should be an integral multiple of the "Minimum Quantity" shown in the package page.

Standard Center Frequency Rank Code

CODE	30kHz Step	25kHz Step	Color Code
D	10.64MHz±30kHz	10.650MHz±25kHz	Black
B	10.67MHz±30kHz	10.675MHz±25kHz	Blue
A	10.70MHz±30kHz	10.700MHz±25kHz	Red
C	10.73MHz±30kHz	10.725MHz±25kHz	Orange
E	10.76MHz±30kHz	10.750MHz±25kHz	White
Z	Combination A, B, C, D, E		
M	Combination A, B, C		

Test Circuit



$R_g + R_1 = R_2 =$ Input and Output Impedance
 $C = 10\text{pF}$ (Including stray capacitance and input capacitance of RF voltmeter.)

- (1) : Input
- (2) : Ground
- (3) : Output

Frequency Characteristics

SFELF10M7KAB0-B0

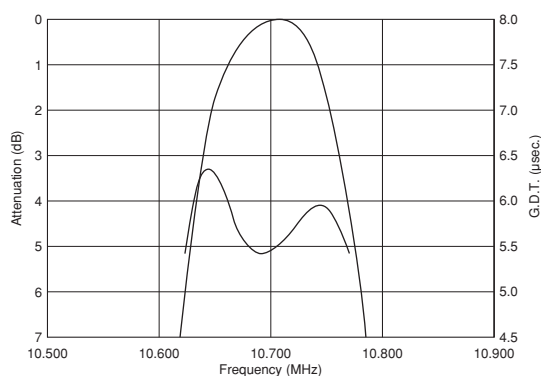

SFELF10M7JAB0-B0

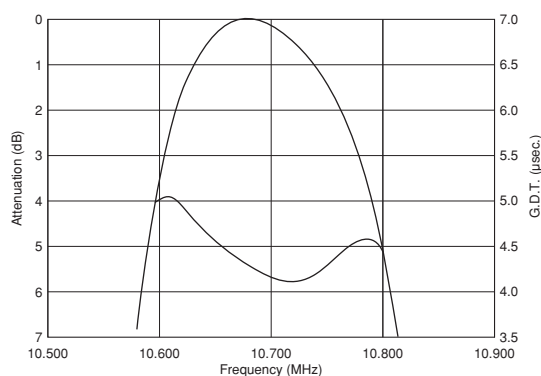

SFELF10M7HAB0-B0

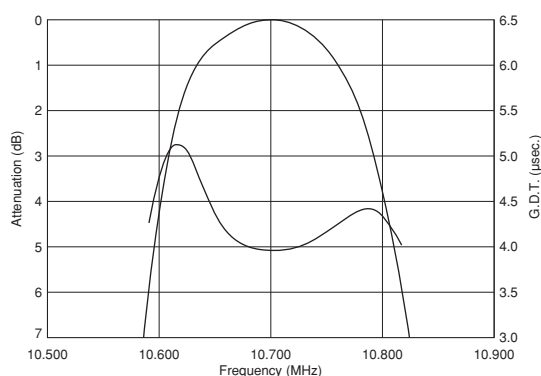

SFELF10M7GAB0-B0

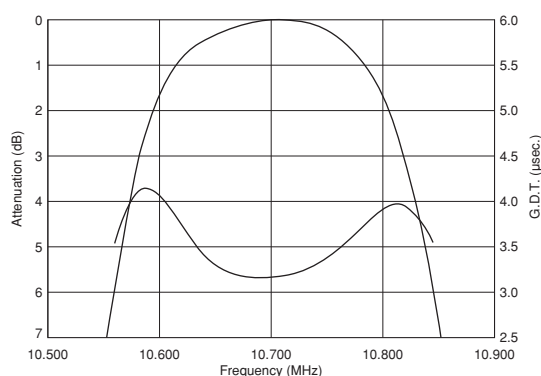

Continued on the following page.

☐ Continued from the preceding page.

■ Frequency Characteristics

SFELF10M7FAB0-B0



5

■ Frequency Characteristics (Spurious)

SFELF10M7KAB0-B0



SFELF10M7JAB0-B0



SFELF10M7HAB0-B0



SFELF10M7GAB0-B0



SFELF10M7FAB0-B0



CERAFIL® (CERAFIL® 10.7MHz) for Audio/Visual Equipment



Wide Bandwidth Type SFELF Series

SFELF10M7 series for FM-receivers are monolithic type ceramic filters that use the thickness expander mode of the piezoelectric ceramic.

As part of the environment protection program, the solder for terminal plating and terminal-element connection inside of the ceramic filter contain no lead (Pb).

■ Features

Realizes wider band characteristics not obtained by conventional ceramic filters.



SFELF10M7EA00-B0



SFELF10M7DF00-B0



Part Number	Center Frequency (fo) (MHz)	Nominal Center Frequency (fn) (MHz)	3dB Bandwidth (kHz)	Attenuation (kHz)	Insertion Loss (dB)	Spurious Attenuation (1) (dB)	Spurious Attenuation (2) (dB)	Input/Output Impedance (ohm)
SFELF10M7EA00-B0	10.700 ±30kHz	-	330 ±50kHz	680 max.	4.0±2.0dB	30 min. [within 9MHz to fo]	30 min. [within fo to 12MHz]	330
SFELF10M7DF00-B0	-	10.700	fn±175 min.	950 max.	3.0±2.0dB	20 min. [within 5MHz to fn]	20 min. [within fn to 15MHz]	470

Area of Attenuation: [within 20dB]

Area of Insertion Loss: at minimum loss point

Center frequency (fo) defined by the center of 3dB bandwidth.

For safety purposes, connect the output of filters to the IF amplifier through a D.C. blocking capacitor. Avoid applying a direct current to the output of ceramic filters.

The order quantity should be an integral multiple of the "Minimum Quantity" shown in the package page.

■ Standard Center Frequency Rank Code (SFELF10M7EA00-B0)

CODE	30kHz Step	25kHz Step	Color Code
D	10.64MHz±30kHz	10.650MHz±25kHz	Black
B	10.67MHz±30kHz	10.675MHz±25kHz	Blue
A	10.70MHz±30kHz	10.700MHz±25kHz	Red
C	10.73MHz±30kHz	10.725MHz±25kHz	Orange
E	10.76MHz±30kHz	10.750MHz±25kHz	White
Z	Combination A, B, C, D, E		
M	Combination A, B, C		

■ Test Circuit



$R_g + R_1 = R_2 =$ Input and Output Impedance
 $C = 10\text{pF}$ (Including stray capacitance and input capacitance of RF voltmeter.)

- (1) : Input
- (2) : Ground
- (3) : Output

■ Frequency Characteristics

SFELF10M7EA00-B0



SFELF10M7DF00-B0



■ Frequency Characteristics (Spurious)

SFELF10M7EA00-B0



SFELF10M7DF00-B0



CERAFIL® (CERAFIL® 10.7MHz) for Audio/Visual Equipment



Narrow Bandwidth Type SFELF Series

■ Features

SFELF10M7LFTA/KAH0 series realizes narrower band characteristics not obtained by conventional ceramic filters. Besides, low spurious and temperature characteristics are stable. This series is suitable for European car-audio or AM upconversion use that needs stable narrow band characteristics. As part of the environment protection program, the solder for terminal plating and terminal-element connection inside of the ceramic filter contain no lead (Pb).



Part Number	Center Frequency (fo) (MHz)	Nominal Center Frequency (fn) (MHz)	3dB Bandwidth (kHz)	Attenuation (kHz)	Insertion Loss (dB)	Spurious Attenuation (1) (dB)	Spurious Attenuation (2) (dB)	Input/Output Impedance (ohm)
SFELF10M7LFTA-B0	-	10.700	fn±25 min.	280 max.	7.0±2.0dB	30 min. [within 9MHz to fn]	30 min. [within fn to 12MHz]	330
SFELF10M7KAH0-B0	10.700 ±30kHz	-	110 ±30kHz	350 max.	7.0±2.0dB	30 min. [within 9MHz to fo]	30 min. [within fo to 12MHz]	330

Area of Attenuation: [within 20dB]

Area of Insertion Loss: at minimum loss point

Center frequency (fo) defined by the center of 3dB bandwidth.

For safety purposes, connect the output of filters to the IF amplifier through a D.C. blocking capacitor. Avoid applying a direct current to the output of ceramic filters.

The order quantity should be an integral multiple of the "Minimum Quantity" shown in the package page.

■ Standard Center Frequency Rank Code (SFELF10M7KAH0-B0)

CODE	30kHz Step	25kHz Step	Color Code
D	10.64MHz±30kHz	10.650MHz±25kHz	Black
B	10.67MHz±30kHz	10.675MHz±25kHz	Blue
A	10.70MHz±30kHz	10.700MHz±25kHz	Red
C	10.73MHz±30kHz	10.725MHz±25kHz	Orange
E	10.76MHz±30kHz	10.750MHz±25kHz	White
Z	Combination A, B, C, D, E		
M	Combination A, B, C		

■ Test Circuit



$R_g + R_1 = R_2 =$ Input and Output Impedance
 $C = 10\text{pF}$ (Including stray capacitance and input capacitance of RF voltmeter.)

- (1) : Input
- (2) : Ground
- (3) : Output

■ Frequency Characteristics

SFELF10M7LFTA-B0



SFELF10M7KAH0-B0



■ Frequency Characteristics (Spurious)

SFELF10M7LFTA-B0

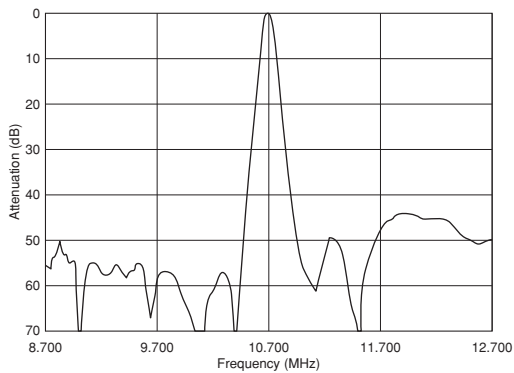

SFELF10M7KAH0-B0

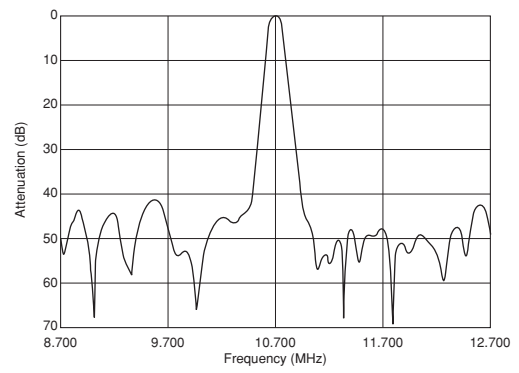

7

CERAFIL® (CERAFIL® 10.7MHz) for Audio/Visual Equipment



For FM-IF Tuners SFELF Series

SFELF10M7 series for FM-receivers are monolithic type ceramic filters that use the thickness expander mode of the piezoelectric ceramic.

As part of the environment protection program, the solder for terminal plating and terminal-element connection inside of the ceramic filter contain no lead (Pb).

■ Features

1. Little dispersion of amplitude characteristics and phase characteristics (G. D. T. characteristics)
2. The SFELF_G series is based on SFELF_FA00/GA00/HA00, and it obtains high selectivity with low loss. There is little dispersion of amplitude and GDT characteristics, and low distortion rate can be obtained.
3. The flatness of GDT is inspected for all products.



SFELF10M7HA0G-B0



SFELF10M7GA0G-B0



SFELF10M7FA0G-B0



Part Number	Center Frequency (fo) (MHz)	3dB Bandwidth (kHz)	Attenuation (kHz)	Insertion Loss (dB)	Spurious Attenuation (1) (dB)	Spurious Attenuation (2) (dB)	GDT Bandwidth (kHz)	Input/Output Impedance (ohm)
SFELF10M7HA0G-B0	10.700 ±30kHz	180 ±40kHz	520 max.	7.0max.	40 min. [within 9MHz to fo]	40 min. [within fo to 12MHz]	fo±45min.	330
SFELF10M7GA0G-B0	10.700 ±30kHz	230 ±50kHz	600 max.	7.0max.	40 min. [within 9MHz to fo]	40 min. [within fo to 12MHz]	fo±60min.	330
SFELF10M7FA0G-B0	10.700 ±30kHz	280 ±50kHz	650 max.	4.0±2.0dB	30 min. [within 9MHz to fo]	30 min. [within fo to 12MHz]	fo±85min.	330

Area of Attenuation: [within 20dB]

Area of Insertion Loss: at minimum loss point

Center frequency (fo) defined by the center of 3dB bandwidth.

For safety purposes, connect the output of filters to the IF amplifier through a D.C. blocking capacitor. Avoid applying a direct current to the output of ceramic filters.

The order quantity should be an integral multiple of the "Minimum Quantity" shown in the package page.

Standard Center Frequency Rank Code

CODE	30kHz Step	25kHz Step	Color Code
D	10.64MHz±30kHz	10.650MHz±25kHz	Black
B	10.67MHz±30kHz	10.675MHz±25kHz	Blue
A	10.70MHz±30kHz	10.700MHz±25kHz	Red
C	10.73MHz±30kHz	10.725MHz±25kHz	Orange
E	10.76MHz±30kHz	10.750MHz±25kHz	White
Z	Combination A, B, C, D, E		
M	Combination A, B, C		

Test Circuit



$R_g + R_1 = R_2 =$ Input and Output Impedance
 $C = 10\text{pF}$ (Including stray capacitance and input capacitance of RF voltmeter.)

(1) : Input
 (2) : Ground
 (3) : Output

Frequency Characteristics

SFELF10M7HA0G-B0



SFELF10M7GA0G-B0

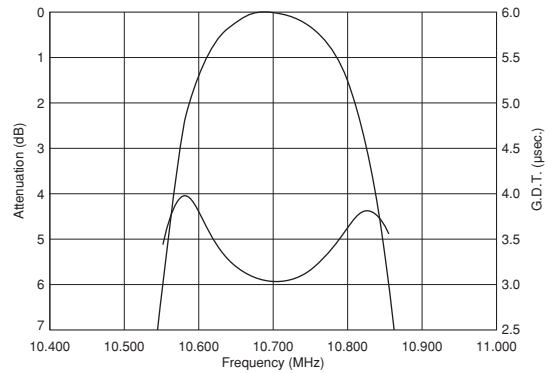

SFELF10M7FA0G-B0



■ Frequency Characteristics (Spurious)

SFELF10M7HA0G-B0



SFELF10M7GA0G-B0



SFELF10M7FA0G-B0



CERAFIL® 10.7MHz Related Data on Lead Type

Temperature Characteristics



Matching Conditions

- When using ceramic filters, it is most important to match the input/output load to impedance 330 ohm (SFELF10M7DF00-B0 is 470 ohm).
 Waveform symmetry is damaged when reactance is added to the input/output load.
- Two ceramic filters directly connected can be used for high selectivity. For reducing waveform variation, it is recommended to input a buffer AMP between ceramic filters.

- The SFELF10M7 series are of input/output symmetric structure so that in theory there is no input/output directionality. Actual circuits may use different input/output loading conditions (for example, mismatched impedance) or capacitance load. In such cases, the waveform will be a little changed by the direction of the input/output of the ceramic filters.

Loaded Resistance and Waveform (Rg+R1=330 ohm)

SFELF10M7GA00-B0

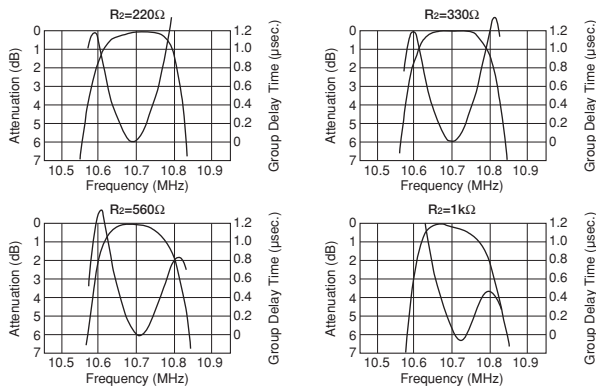

Loaded Capacitance and Waveform (Rg+R1=R2=330 ohm)

SFELF10M7HA00-B0

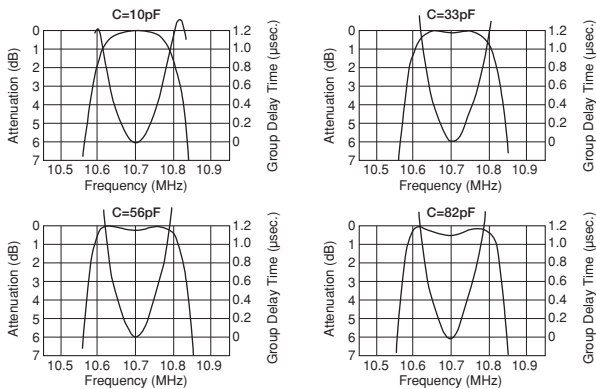

CERAFIL® (CERAFIL® 2.3-6.5MHz) for Audio/Visual Equipment



4.5-6.5MHz Chip Type SFSKA Series

SMD ceramic filter SFSKA_CF is a small and thin SMD filter sealed with a metal cap.
 Recommended for LCD-TVs, and small and thin tuners.

■ Features

1. High attenuation outside bandwidth
2. Small and thin package
3. Reflow-solderable



Part Number	Nominal Center Frequency (fn) (MHz)	3dB Bandwidth (kHz)	20dB Bandwidth (kHz)	Insertion Loss (dB)	Spurious Attenuation(1) (dB)	Spurious Attenuation(2) (dB)	Input/Output Impedance (ohm)
SFSKA4M50CF00-R3	4.500	fn±60 min.	600 max.	6.0 max.	20 min. [within 0 to fn]	15 min. [within fn to 7.0MHz]	1000
SFSKA5M50CF00-R3	5.500	fn±60 min.	600 max.	6.0 max.	25 min. [within 0 to fn]	15 min. [within fn to 7.0MHz]	600
SFSKA6M00CF00-R3	6.000	fn±60 min.	600 max.	6.0 max.	25 min. [within 0 to fn]	15 min. [within fn to 7.5MHz]	470
SFSKA6M50CF00-R3	6.500	fn±60 min.	600 max.	6.0 max.	25 min. [within 0 to fn]	15 min. [within fn to 8.5MHz]	470

Area of Insertion Loss: at minimum loss point

For safety purposes, connect the output of filters to the IF amplifier through a D.C. blocking capacitor. Avoid applying a direct current to the output of ceramic filters.
 The order quantity should be an integral multiple of the "Minimum Quantity" shown in the package page.

■ Standard Land Pattern Dimensions



■ Test Circuit

SFSKA4M50CF00-R3



Continued on the following page.

☞ Continued from the preceding page.

■ Test Circuit

SFSKA5M50CF00-R3



$R1+Rg=R2=600\Omega \pm 5\%$, $Rg=50\Omega$
 $C2=10pF$ (Including stray capacitance and Input capacitance of RF Voltmeter)
 E1: S.S.G. Output voltage
 (1) : Input
 (2) : Ground
 (3) : Output

SFSKA6M00CF00-R3

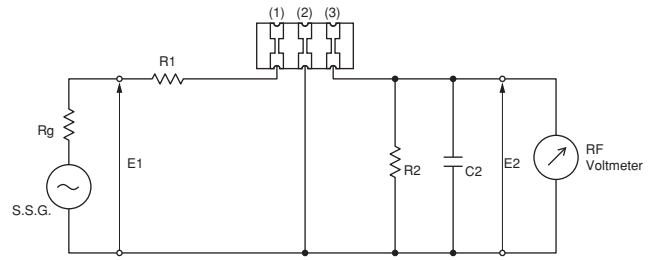

$R1+Rg=R2=470\Omega \pm 5\%$, $Rg=50\Omega$
 $C2=10pF$ (Including stray capacitance and Input capacitance of RF Voltmeter)
 E1: S.S.G. Output voltage
 (1) : Input
 (2) : Ground
 (3) : Output

SFSKA6M50CF00-R3



$R1+Rg=R2=470\Omega \pm 5\%$, $Rg=50\Omega$
 $C2=10pF$ (Including stray capacitance and Input capacitance of RF Voltmeter)
 E1: S.S.G. Output voltage
 (1) : Input
 (2) : Ground
 (3) : Output

■ Frequency Characteristics

SFSKA4M50CF00-R3

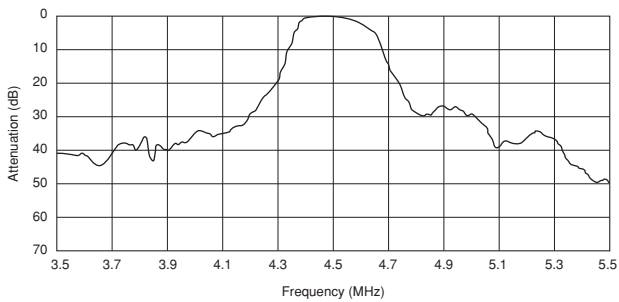

SFSKA5M50CF00-R3



SFSKA6M00CF00-R3



SFSKA6M50CF00-R3



9

■ Frequency Characteristics (Spurious)

SFSKA4M50CF00-R3



SFSKA5M50CF00-R3



SFSKA6M00CF00-R3



SFSKA6M50CF00-R3



CERAFIL® (CERAFIL® 2.3-6.5MHz) for Audio/Visual Equipment



2.3-5.7MHz Chip Type SFSKB Series

The SFSKB series are SMD ceramic filters suitable for IR headphone applications.

Center frequencies of 2.3, 2.8, 3.2, 3.8, 4.3, 4.8, 5.2, 5.7MHz are available.

Realized small, thin and lightweight package, compared with conventional LC filters.

It helps to compose multi-channel circuit on one PCB.

No frequency adjustment is required on PCB and it contributes to the reduction of production cost.

■ Features

1. SMD package in plastic emboss tape, available for automatic placing.
2. They are slim, at only 1.5mm max. thickness, and have a small mounting area (5.2x3.8mm) enabling flexible PCB design.
3. Available for lead (Pb) free reflow soldering process.
4. Operating temperature range: 0 to +70°C
Storage temperature range: -55 to +85°C
5. No frequency adjustment is required in production process.
6. Small, thin and lightweight package compared with conventional LC filters

■ Applications

1. IR headphone
2. Set Top Box for satellite broadcasting

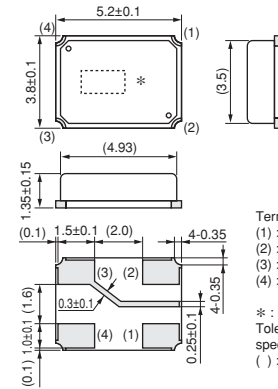

Part Number	Nominal Center Frequency (fn) (MHz)	3dB Bandwidth (kHz)	20dB Bandwidth (kHz)	Insertion Loss (dB)	Spurious Attenuation(1) (dB)	Spurious Attenuation(2) (dB)	Input/Output Impedance (ohm)
SFSKB2M30GF00-R1	2.300	fn±75 min.	650 max.	6.0 max.	25 min. [within 1.3 to 1.8MHz]	23 min. [within 2.8 to 3.3MHz]	1000
SFSKB2M80GF00-R1	2.800	fn±75 min.	650 max.	6.0 max.	25 min. [within 1.8 to 2.3MHz]	25 min. [within 3.3 to 3.8MHz]	1000
SFSKB3M20FF00-R1	3.200	fn±75 min.	650 max.	6.0 max.	30 min. [within 2.2 to 2.8MHz]	30 min. [within 3.8 to 4.2MHz]	1000
SFSKB3M80GF00-R1	3.800	fn±75 min.	650 max.	6.0 max.	30 min. [within 2.8 to 3.2MHz]	30 min. [within 4.3 to 4.8MHz]	1000
SFSKB4M30GF00-R1	4.300	fn±75 min.	650 max.	6.0 max.	30 min. [within 3.3 to 3.8MHz]	30 min. [within 4.8 to 5.3MHz]	1000
SFSKB4M80GF00-R1	4.800	fn±75 min.	650 max.	6.0 max.	30 min. [within 3.8 to 4.3MHz]	30 min. [within 5.2 to 5.8MHz]	1000
SFSKB5M20GF00-R1	5.200	fn±75 min.	650 max.	6.0 max.	30 min. [within 4.2 to 4.8MHz]	30 min. [within 5.7 to 6.2MHz]	1000
SFSKB5M70GF00-R1	5.700	fn±75 min.	650 max.	6.0 max.	30 min. [within 4.7 to 5.2MHz]	30 min. [within 6.2 to 6.7MHz]	1000

For safety purposes, connect the output of filters to the IF amplifier through a D.C. blocking capacitor. Avoid applying a direct current to the output of ceramic filters.
 The order quantity should be an integral multiple of the "Minimum Quantity" shown in the package page.

Standard Land Pattern Dimensions



(in mm)

Test Circuit

SFSKB2M30GF00-R1/SFSKB3MZ0GF00-R1



$R1+Rg=R2=1.0k\Omega$
 $Cc=22pF\pm5\%$
 $C2=10pF$ (Including stray capacitance and Input capacitance of RF Voltmeter)
 E1 : S.S.G. Output Voltage

(1) : Input
 (2) : Output
 (3) : Ground
 (4) : Terminal for external capacitor

SFSKB2M80GF00-R1/SFSKB3M20FF00-R1



$R1+Rg=R2=1.0k\Omega$
 $Cc=39pF\pm5\%$
 $C2=10pF$ (Including stray capacitance and Input capacitance of RF Voltmeter)
 E1 : S.S.G. Output Voltage

(1) : Input
 (2) : Output
 (3) : Ground
 (4) : Terminal for external capacitor

SFSKB4M30GF00-R1/SFSKB5M70GF00-R1



$R1+Rg=R2=1.0k\Omega$
 $Cc=33pF\pm5\%$
 $C2=10pF$ (Including stray capacitance and Input capacitance of RF Voltmeter)
 E1 : S.S.G. Output Voltage

(1) : Input
 (2) : Output
 (3) : Ground
 (4) : Terminal for external capacitor

SFSKB4M80GF00-R1



$R1+Rg=R2=1.0k\Omega$
 $Cc=15pF\pm5\%$
 $C2=10pF$ (Including stray capacitance and Input capacitance of RF Voltmeter)
 E1 : S.S.G. Output Voltage

(1) : Input
 (2) : Output
 (3) : Ground
 (4) : Terminal for external capacitor

SFSKB5M20GF00-R1



$R1+Rg=R2=1.0k\Omega$
 $Cc=27pF\pm5\%$
 $C2=10pF$ (Including stray capacitance and Input capacitance of RF Voltmeter)
 E1 : S.S.G. Output Voltage

(1) : Input
 (2) : Output
 (3) : Ground
 (4) : Terminal for external capacitor

10

■ Frequency Characteristics

SFSKB2M30GF00-R1



SFSKB2M80GF00-R1



SFSKB3M20FF00-R1



SFSKB3M80GF00-R1



SFSKB4M30GF00-R1



SFSKB4M80GF00-R1



SFSKB5M20GF00-R1



SFSKB5M70GF00-R1



10

■ Frequency Characteristics (Spurious)

SFSKB2M30GF00-R1



SFSKB2M80GF00-R1



SFSKB3M20FF00-R1



SFSKB3M80GF00-R1



SFSKB4M30GF00-R1



SFSKB4M80GF00-R1



SFSKB5M20GF00-R1



SFSKB5M70GF00-R1



10

CERAFIL® (CERAFIL® 455kHz) for Audio/Visual Equipment



Chip Type SFPKA Series

SFPKA series for AM use is one of the most recommendable intermediate filters, having such distinctive features as high selectivity, high stability and adjustment-free operation. Additionally, its easy matching with IC helps create an easy circuit design.

■ Features

1. The filters are mountable by automatic placers and can be reflow soldered and withstand washing.
2. The filters are wide bandwidth and high selectivity, so they are suitable for car radio and multi-band radio.



Part Number	Center Frequency (fo) (kHz)	6dB Bandwidth (kHz)	Selectivity (-) (dB)	Selectivity (+) (dB)	Insertion Loss (dB)	Input/Output Impedance (ohm)	Element
SFPKA450KH1A-R1	450.0 ±1.0kHz	fn±3.0 min.	40 min.[fn-9kHz]	40 min.[fn+9kHz]	6.0 max.	2000	4
SFPKA450KG1A-R1	450.0 ±1.0kHz	fn±4.5 min.	40 min.[fn-10kHz]	40 min.[fn+10kHz]	6.0 max.	1500	4

Area of Insertion Loss: at minimum loss point

Center frequency (fo) is defined by the center of 6dB bandwidth.

(fn) means nominal center frequency (450kHz).

For safety purposes, connect the output of filters to the IF amplifier through a D.C. blocking capacitor. Avoid applying a direct current to the output of ceramic filters.

The order quantity should be an integral multiple of the "Minimum Quantity" shown in the package page.

■ Standard Land Pattern Dimensions



■ Recommended IFT

Item	Type	SFPKA		
		(1)-(2)	(2)-(3)	(4)-(6)
Winding Specification	 (Bottom view)			
		60T	125T	28T
No load Qu		40		
Tuning Capacitance		180pF		

• Matching of CERAFIL® SFPKA series with IFT is decided by the Qu of IFT and IFT secondary side impedance, |Z2|. Set the Qu at about 40 because a Qu value which is too high (e.g., 90) may produce ripple in the waveform. It is recommended to match the impedance of |Z2| with that of the CERAFIL®.

■ Test Circuit



■ Frequency Characteristics

SFPKA450KH1A-R1



SFPKA450KG1A-R1



CERAFIL® (CERAFIL® 455kHz) for Audio/Visual Equipment



Lead Type SFPLA/CFWLA Series

SFPLA/CFWLA series for AM use is one of the most suitable intermediate filters, having such distinctive features as high selectivity, high stability, high attenuation, and adjustment-free operation. Additionally, its easy matching with IC helps create an easy circuit design. This is the most suitable for car stereo and all band radio with high attenuation.



SFPLA Series



CFWLA Series

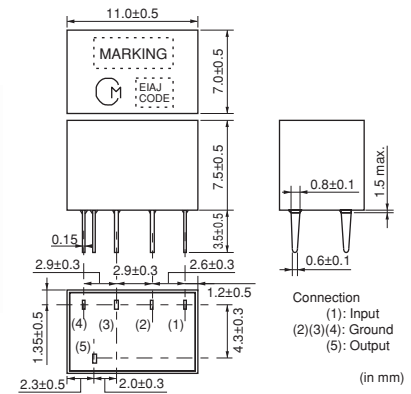

Part Number	Center Frequency (fo) (kHz)	6dB Bandwidth (kHz)	Selectivity (-) (dB)	Selectivity (+) (dB)	Insertion Loss (dB)	Input/Output Impedance (ohm)	Element
SFPLA450KJ1A-B0	450.0 ±1.0kHz	fn±2.0 min.	40 min.[fn-7.5kHz]	40 min.[fn+7.5kHz]	6.0 max.	2000	4
SFPLA450KH1A-B0	450.0 ±1.0kHz	fn±3.0 min.	40 min.[fn-9kHz]	40 min.[fn+9kHz]	6.0 max.	2000	4
CFWLA450KJFA-B0	450.0 (fn)	fn±2.0 min.	50 min.[fn-7.5kHz]	50 min.[fn+7.5kHz]	7.0 max.	2000	6
CFWLA450KHFA-B0	450.0 (fn)	fn±3.0 min.	50 min.[fn-9kHz]	50 min.[fn+9kHz]	6.0 max.	2000	6

Area of Insertion Loss: at minimum loss point

Center frequency (fo) is defined by the center of 6dB bandwidth.

(fn) means nominal center frequency (450kHz).

For safety purposes, connect the output of filters to the IF amplifier through a D.C. blocking capacitor. Avoid applying a direct current to the output of ceramic filters.

The order quantity should be an integral multiple of the "Minimum Quantity" shown in the package page.

12

Recommended IFT

Item	Type	SFPLA/CFWLA		
		7x7mm IFT		
Winding Specification		(1)–(2)	(2)–(3)	(4)–(6)
S(3) (2) (1)		60T	125T	28T
No load Qu		40		
Tuning Capacitance		180pF		

• Matching of CERAFIL® SFPLA/CFWLA series with IFT is decided by the Qu of IFT and IFT secondary side impedance, |Z2|. Set the Qu at about 40 because a Qu value which is too high (e.g., 90) may produce ripple in the waveform. It is recommended to match the impedance of |Z2| with that of the CERAFIL®.

Test Circuit



Rg+R1 = R2 : Input/Output Impedance

■ Frequency Characteristics

IFT+SFPLA450KH1A-B0



IFT+CFWLA450KHFA-B0



■ Frequency Characteristics (Spurious)

IFT+SFPLA450KH1A-B0



IFT+CFWLA450KHFA-B0



CERAFIL® (CERAFIL® 455kHz) for Audio/Visual Equipment



For AM Stereo Wide Bandwidth Type SFPLA/CFWLA/CFULA Series

SFPLA/CFULA/CFWLA series for AM use is one of the most suitable intermediate filters, having such distinctive features as high selectivity, high stability, high attenuation, and adjustment-free operation. Additionally, its easy matching with IC helps create an easy circuit design.

Especially, CFULA/CFWLA_Y series improves the frequency fidelity in the high sound area of an AM stereo with its wide band and flat characteristics of group delay time.



SFPLA Series



CFWLA Series



CFULA Series



Part Number	Center Frequency (fo) (kHz)	6dB Bandwidth (kHz)	Selectivity (-) (dB)	Selectivity (+) (dB)	Insertion Loss (dB)	GDT 20µsec. Bandwidth (kHz)	Input/Output Impedance (ohm)	Element
SFPLA450KG1A-B0	450.0 ±1.0kHz	fn±4.5 min.	30 min.[fn-9kHz]	30 min.[fn+9kHz]	6.0 max.	-	2000	4
SFPLA450KF1A-B0	450.0 ±1.0kHz	fn±6.0 min.	40 min.[fn-12.5kHz]	40 min.[fn+12.5kHz]	6.0 max.	-	2000	4
SFPLA450KE1A-B0	450.0 ±1.0kHz	fn±7.5 min.	40 min.[fn-15kHz]	40 min.[fn+15kHz]	6.0 max.	-	1500	4
SFPLA450KD1A-B0	450.0 ±1.0kHz	fn±10.0 min.	40 min.[fn-20kHz]	40 min.[fn+20kHz]	4.0 max.	-	1500	4
CFULA450KG1Y-B0	450.0 ±1.0kHz	fn±4.5 min.	40 min.[fn-15kHz]	40 min.[fn+15kHz]	10.0 max.	fn±3	2000	4
CFULA450KF1Y-B0	450.0 ±1.0kHz	fn±6.0 min.	40 min.[fn-17.5kHz]	40 min.[fn+17.5kHz]	9.0 max.	fn±4	2000	4
CFULA450KD1Y-B0	450.0 ±1.0kHz	fn±10.0 min.	40 min.[fn-25kHz]	40 min.[fn+25kHz]	7.0 max.	fn±7	1500	4
CFWLA450KG1Y-B0	450.0 ±1.0kHz	fn±4.5 min.	50 min.[fn-15kHz]	50 min.[fn+15kHz]	11.0 max.	fn±4	2000	6
CFWLA450KF1Y-B0	450.0 ±1.0kHz	fn±6.0 min.	50 min.[fn-17.5kHz]	50 min.[fn+17.5kHz]	10.0 max.	fn±5	2000	6
CFWLA450KD1Y-B0	450.0 ±1.0kHz	fn±10.0 min.	50 min.[fn-25kHz]	50 min.[fn+25kHz]	8.0 max.	fn±8	1500	6
CFWLA450KGFA-B0	450.0 (fn)	fn±4.5 min.	50 min.[fn-10kHz]	50 min.[fn+10kHz]	6.0 max.	-	2000	6
CFWLA450KFFA-B0	450.0 (fn)	fn±6.0 min.	50 min.[fn-12.5kHz]	50 min.[fn+12.5kHz]	6.0 max.	-	2000	6
CFWLA450KEFA-B0	450.0 (fn)	fn±7.5 min.	50 min.[fn-15kHz]	50 min.[fn+15kHz]	6.0 max.	-	1500	6
CFWLA450KDFA-B0	450.0 (fn)	fn±10.0 min.	50 min.[fn-20kHz]	50 min.[fn+20kHz]	4.0 max.	-	1500	6

Area of Insertion Loss: at minimum loss point
 Center frequency (fo) is defined by the center of 6dB bandwidth.
 (fn) means nominal center frequency (450kHz).

For safety purposes, connect the output of filters to the IF amplifier through a D.C. blocking capacitor. Avoid applying a direct current to the output of ceramic filters.
 The order quantity should be an integral multiple of the "Minimum Quantity" shown in the package page.

Recommended IFT

Item	Type	SFPLA/CFULA/CFWLA		
		7x7mm IFT		
Winding Specification		(1)—(2)	(2)—(3)	(4)—(6)
S(3) (2) (1) (Bottom view)		60T	125T	28T
No load Qu		40		
Tuning Capacitance		180pF		

• Matching of CERAFIL® SFPLA/CFULA/CFWLA series with IFT is decided by the Qu of IFT and IFT secondary side impedance, |Z2|. Set the Qu at about 40 because a Qu value which is too high (e.g., 90) may produce ripple in the waveform. It is recommended to match the impedance of |Z2| with that of the CERAFIL®.

Test Circuit



$R_g + R_1 = R_2$: Input/Output Impedance

Frequency Characteristics

IFT+SFPLA450KF1A-B0



IFT+CFWLA450KFFA-B0



IFT+CFULA450KF1Y-B0



IFT+CFWLA450KF1Y-B0



CERAFIL® 455kHz SF□ Series Temperature Characteristics

■ SFPLA450KH1A-B0



CERAFIL® (Ceramic Trap) for Audio/Visual Equipment



4.5-6.5MHz Chip Type TPSKA Series

SMD ceramic trap TPSKA_B is a small and thin SMD trap sealed with a metal cap recommended for LCD-TVs, and small and thin tuners.

■ Features

1. High attenuation and high performance group delay time
2. Small and thin package
3. Reflow-solderable



Part Number	Nominal Center Frequency (fn1) (MHz)	Attenuation (at fn1) (dB)	30dB Attenuation BW (fn1) (kHz)
TPSKA4M50B00-R3	4.500	35 min.	50 min.
TPSKA5M50B00-R3	5.500	35 min.	70 min.
TPSKA6M00B00-R3	6.000	35 min.	70 min.
TPSKA6M50B00-R3	6.500	35 min.	70 min.

For safety purposes, connect the output of filters to the IF amplifier through a D.C. blocking capacitor. Avoid applying a direct current to the output of ceramic filters. The order quantity should be an integral multiple of the "Minimum Quantity" shown in the package page.

■ Standard Land Pattern Dimensions



■ Test Circuit

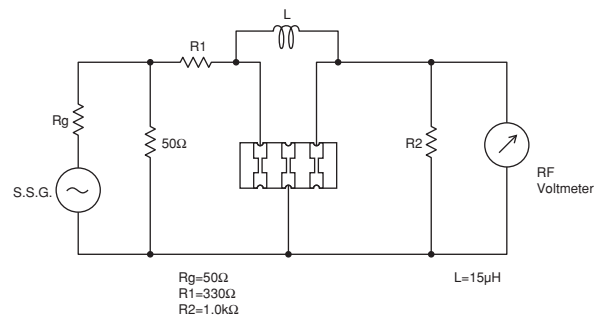

■ Frequency Characteristics

TPSKA4M50B00-R3

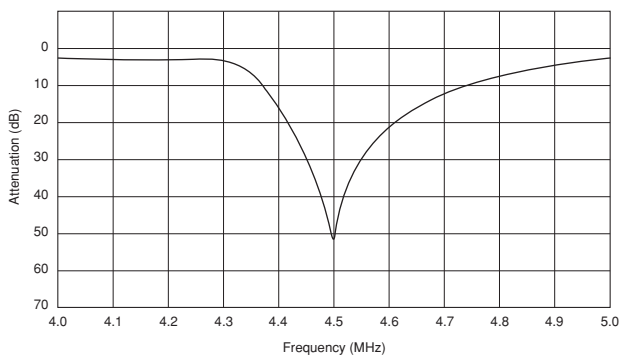

TPSKA5M50B00-R3



Continued on the following page. ↗

☐ Continued from the preceding page.

■ Frequency Characteristics

TPSKA6M00B00-R3



TPSKA6M50B00-R3



■ Frequency Characteristics (Spurious)

TPSKA4M50B00-R3



TPSKA5M50B00-R3



TPSKA6M00B00-R3

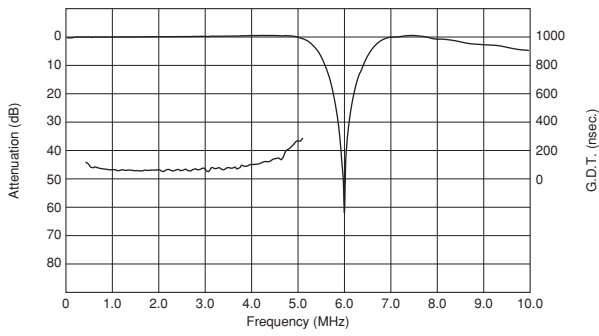

TPSKA6M50B00-R3



CERAFIL® (Ceramic Discriminator) for Audio/Visual Equipment



10.7MHz Ultra Thin Chip Type CDSCB Series

CDSCB10M7 series forms a resonator on a piezoelectric ceramic substrate. In combination with ICs, this type obtains stable demodulation characteristics in a wide bandwidth. They have 1.0mm max. thickness and small mounting area (4.5x2.0mm).



■ Features

1. Compact and high reliability and recommended for automotive applications.
2. Can be combined with various ICs. The IC is determined by the last number in the part number.
3. Stable demodulation characteristics can be obtained without adjustment.
4. Stable temperature characteristics.
5. Available lead (Pb) free solder reflow.

Part Number	Center Frequency (fo) (MHz)	Recovered Audio 3dB BW (kHz)	Recovered Audio Output (mV)	Distortion (%)	S Curve (mV)	IC
CDSCB10M7GA105A-R0	10.700 ±30kHz	220 min.	110 min.	1.5 max.	-	TEA5757HL
CDSCB10M7GA113-R0	10.700 ±30kHz	300 min.	110 min.	1.0 max.	-	TA2154FN
CDSCB10M7GA119-R0	10.700 ±30kHz	500 min.	75 min.	1.0 max.	-	TRF6901
CDSCB10M7GA121-R0	10.700 ±30kHz	390 min.	80 min.	1.0 max.	-	LV23100V
CDSCB10M7GA135-R0	10.700 ±30kHz	155 min.	75 min.	-	-	TH71101
CDSCB10M7GA136-R0	10.700 ±30kHz	140 min.	120 min.	-	-	TH7122
CDSCB10M7GF072-R0	10.700 (fn)	fn±150 min.	130 min.	2.0 max.	-	TA31161
CDSCB10M7GF107S-R0	10.700 (fn)	fn±80 min.	52 min.	3.0 max.	-	TA31272FN
CDSCB10M7GF109-R0	10.700 (fn)	fn±100 min.	170 min.	3.0 max.	-	TK14588V
CDSCB10M7GF123-R0	10.700 (fn)	-	-	-	900 min.	TA31275FN
CDSCB10M7GF123S-R0	10.700 (fn)	-	-	-	900 min.	TA31275FN
CDSCB10M7GF126-R0	10.700 (fn)	-	-	-	400 min.	NJM2295AV

(fn) means nominal center frequency (10.700MHz).

For safety purposes, avoid applying a direct current between the terminals.

The order quantity should be an integral multiple of the "Minimum Quantity" shown in the package page.

■ Standard Center Frequency Rank Code

CODE	30kHz Step	25kHz Step
D	10.64MHz±30kHz	10.650MHz±25kHz
B	10.67MHz±30kHz	10.675MHz±25kHz
A	10.70MHz±30kHz	10.700MHz±25kHz
C	10.73MHz±30kHz	10.725MHz±25kHz
E	10.76MHz±30kHz	10.750MHz±25kHz
Z	Combination A, B, C, D, E	
M	Combination A, B, C	

■ Recovered Audio Curve



Continued on the following page. ↗

Continued from the preceding page.

Recovered Audio Curve



S Curve



Ceramic Discriminator 10.7MHz Applied IC Reference Table

Please see the following table to reference applied IC.

If you cannot find the IC part number you are seeking, please contact our sales representative.

ex. : CDSCB10M7GA105A-R0

Suffix Number

IC Manufacturer	IC Part Number	Suffix Number
ATMEL	U4313B	081
	U4490B	034V
INFINEON	TDA1576T	051
	TDA6160X	038
Panasonic	AN7004	011
	AN7232	053
Freescale	MC13156	049
	MC13158	073
Renesas	μPC1391M	056
NXP	NE604	020
	SA605	042
	SA626	047
	SA636DK	096
	SA639	085
	TDA1596T	120
	TEA5710	040
	TEA5757HL	105A
	TEA5762 / 5757	061
	UAA3220TS	098
ROHM	BA1448	060
	BA4230AF	005
	BA4234L	004
SAMSUNG	S1A0903	118A
SANYO	LA1225M	108A
	LA1814M	115
	LA1823	101
	LA1827M	083
	LA1831	043
	LA1832 / M	046
	LA1833	086
	LA1835 / M	048
	LA1838 / M	079
	LA7770	023
	LV23000M	114
	LV23100V	121
SONY	CX1691M	078
	CX-20029	001
	CXA1111	093
	CXA1238	027
	CXA1238N	027N
	CX1343M	032
	CXA1376AM	054
	CXA1538M / N / S	069
	CXA1611	075
	CX3067M	076
T. I.	TRF6901	119
TOKO	TK14570L	122
	TK14583V	112
	TK14588V	109

IC Manufacturer	IC Part Number	Suffix Number
TOSHIBA	TA2003	031
	TA2007	033
	TA2008A / AN	045
	TA2022	050
	TA2057	057
	TA2099N	082
	TA2104AFN	080
	TA2104F	080A
	TA2111N / F / FN	077
	TA2132	092
	TA2132BP	092D
	TA2142FN	102
	TA2149AN	100A
	TA2149N	100
	TA2154FN	113
	TA2159F	116
	TA31161	072
	TA31275FN	123
	TA7303P	008
	TA7640AP	006
TA8122AN / AF	016	
TA8132AN / AF	018	
TB2132FN	128	

Notice

■ CERAFIL® 10.7MHz Chip Type SFECF Series

● Soldering and Mounting

1. Standard Reflow Soldering Conditions

(1) Reflow

Filter is soldered twice within the following temperature conditions.



(2) Soldering Iron

Filter is soldered at $+350\pm 5^{\circ}\text{C}$ for 3.0 ± 0.5 seconds. The soldering iron should not touch the filter while soldering.

(3) Conditions for Placement Machines

The component is recommended for use with placement machines that employ optical placement capabilities. The component might be damaged by excessive mechanical force. Please make sure that you have evaluated by using placement machines before going into mass production. Do not use placement machines that utilize mechanical positioning. Please contact Murata for details beforehand.

(4) Other

- (a) The component may be damaged if excess mechanical stress is applied to it mounted on the printed circuit board.
- (b) Design layout of components on the PC board to minimize the stress imposed on the warp or flexure of the board.
- (c) After installing components, if solder is excessively applied to the circuit board, mechanical stress will cause destruction resistance characteristics to degrade. To prevent this, be extremely careful in determining shape and dimension before designing the circuit board diagram.
- (d) When the positioning claws and pick-up nozzle are worn, the load is applied to the components while positioning is concentrated on positioning accuracy, etc. Careful checking and maintenance are necessary to prevent unexpected trouble.
- (e) When correcting components with a soldering iron, the tip of the soldering iron should not directly touch the component. Depending on the soldering conditions, the effective area of terminations may be reduced. Solder containing Ag should be used to prevent electrode erosion.
- (f) Do not use strong acidity flux, more than 0.2wt% chlorine content, in reflow soldering.



Notice

☐ Continued from the preceding page.

2. Wash

Do not clean or wash the component as it is not hermetically sealed.

3. Coating

In case of overcoating the component, conditions such as material of resin, cure temperature, and so on should be evaluated well.

● Storage and Operating Conditions

1. Product Storage Conditions

Please store the products in a room where the temperature/humidity is stable, and avoid places where there are large temperature changes. Please store the products under the following conditions:

Temperature: -10 to +40°C

Humidity: 15 to 85% R.H.

2. Expiration Date on Storage

Expiration date (shelf life) of the products is six months after delivery under the conditions of a sealed and unopened package. Please use the products within six months after delivery. If you store the products for a long time (more than six months), use carefully because solderability may be degraded due to storage under poor conditions.

Please confirm solderability and characteristics for the products regularly.

3. Notice on Product Storage

(1) Please do not store the products in a chemical atmosphere (Acids, Alkali, Bases, Organic gas, Sulfides and so on), because quality and solderability may be degraded due to storage in a chemical atmosphere.

(2) Please do not put the products directly on the floor without anything under them to avoid damp places and/or dusty places.

(3) Please do not store the products in places such as a damp heated place or any place exposed to direct sunlight or excessive vibration.

(4) Please use the products immediately after package is opened, because quality and solderability may be degraded due to storage under poor conditions.

(5) To avoid cracking of ceramic element, please do not drop the products.

4. Other

Please be sure to consult with our sales representative or engineer whenever the products are to be used in conditions not listed above.

● Rating

The component may be damaged if excessive mechanical stress is applied.

● Handling

1. Accurate test circuit values are required to measure electrical characteristics. Miscorrelation may be caused if there is any deviation, especially stray capacitance, from the test circuit in the specification.

2. The components, packed in a moisture proof bag (dry pack), are sensitive to moisture. The following treatment is required before applying reflow soldering, to avoid reliability degradation caused by thermal stress. When unpacked, store the component in an atmosphere of reflow 30°C and below 60%R.H., and solder within 1 week.

3. For safety purposes, connect the output of filters to the IF amplifier through a D.C. blocking capacitor. Avoid applying a direct current to the output of ceramic filters.

Notice

■ CERAFIL® 10.7MHz Chip Type SFECV/SFECK Series

● Soldering and Mounting

1. Standard Reflow Soldering Conditions

(1) Reflow

Filter is soldered twice within the following temperature conditions.



(2) Soldering Iron

Filter is soldered at $+350\pm 5^{\circ}\text{C}$ for 3.0 ± 0.5 seconds. The soldering iron should not touch the filter while soldering.

(3) Conditions for Placement Machines

The component is recommended for use with placement machines that employ optical placement capabilities. Damage may result from excessive mechanical force. Please make sure that you have evaluated by using placement machines before going into mass production. Do not use placement machines that utilize mechanical positioning. Please contact Murata for details beforehand.

(4) Other

- (a) The component may be damaged if excess mechanical stress is applied to it mounted on the printed circuit board.
- (b) Design layout of components on the PC board to minimize the stress imposed on the warp or flexure of the board.
- (c) After installing components, if solder is excessively applied to the circuit board, mechanical stress will cause destruction resistance characteristics to degrade. To prevent this, be extremely careful in determining shape and dimension before designing the circuit board diagram.
- (d) When the positioning claws and pick-up nozzle are worn, the load is applied to the components while positioning is concentrated to one positioning accuracy, etc. Careful checking and maintenance are necessary to prevent unexpected trouble.
- (e) When correcting components with a soldering iron, the tip of the soldering iron should not directly touch the component. Depending on the soldering conditions, the effective area of terminations may be reduced. Solder containing Ag should be used to prevent electrode erosion.
- (f) Do not use strong acidity flux, more than 0.2wt% chlorine content, in reflow soldering.



Continued on the following page. ↗

Notice

☐ Continued from the preceding page.

2. Wash

Do not clean or wash the component as it is not hermetically sealed.

3. Coating

In case of overcoating the component, conditions such as material of resin, cure temperature, and so on should be evaluated well.

● Storage and Operating Conditions

1. Product Storage Conditions

Please store the products in room where the temperature/humidity is stable, and avoid places where there are large temperature changes. Please store the products under the following conditions:

Temperature: -10 to +40°C

Humidity: 15 to 85% R.H.

2. Expiration Date on Storage

Expiration date (Shelf life) of the products is six months after delivery under the conditions of a sealed and unopened package. Please use the products within six months after delivery. If you store the products for a long time (more than six months), use carefully because the products may be degraded in solderability due to storage under poor conditions.

Please confirm solderability and characteristics for the products regularly.

3. Notice on Product Storage

(1) Please do not store the products in a chemical atmosphere (Acids, Alkali, Bases, Organic gas, Sulfides and so on), because quality and solderability may be degraded due to the storage in a chemical atmosphere.

- (2) Please do not put the products directly on the floor without anything under them to avoid damp places and/or dusty places.
- (3) Please do not store the products in the places such as a damp heated place or any place exposed to direct sunlight or excessive vibration.
- (4) Please use the products immediately after package is opened, because quality and solderability may be degraded due to storage under the poor conditions.
- (5) To avoid cracking of ceramic element, please do not drop the products.

4. Other

Please be sure to consult with our sales representative or engineer whenever the products are to be used in conditions not listed above.

● Rating

The component may be damaged if excessive mechanical stress is applied.

● Handling

1. Accurate test circuit values are required to measure electrical characteristics.

Miscorrelation may be caused if there is any deviation, especially stray capacitance, from the test circuit in the specification.

2. For safety purposes, connect the output of filters to the IF amplifier through a D.C. blocking capacitor. Avoid applying a direct current to the output of ceramic filters.

Notice

■ CERAFIL® 10.7MHz Lead Type SFELF Series

● Soldering and Mounting

The component cannot withstand washing.

● Storage and Operating Conditions

1. Product Storage Conditions

Please store the products in room where the temperature/humidity is stable, and avoid such places where there are large temperature changes. Please store the products under the following conditions:

Temperature: -10 to +40°C

Humidity: 15 to 85% R.H.

2. Expiration Date on Storage

Expiration date (Shelf life) of the products is six months after delivery under the conditions of a sealed and unopened package. Please use the products within six months after delivery. If you store the products for a long time (more than six months), use carefully because the products may be degraded in solderability due to storage under poor conditions.

Please confirm solderability and characteristics for the products regularly.

3. Notice on Product Storage

(1) Please do not store the products in a chemical atmosphere (Acids, Alkali, Bases, Organic gas, Sulfides and so on), because quality and solderability may be degraded due to the storage in a chemical atmosphere.

- (2) Please do not put the products directly on the floor without anything under them to avoid damp places and/or dusty places.
- (3) Please do not store the products in the places such as a damp heated place or any place exposed to direct sunlight or excessive vibration.
- (4) Please use the products immediately after package is opened, because quality and solderability may be degraded due to storage under the poor conditions.
- (5) To avoid cracking of ceramic element, please do not drop the products.

4. Other

Please be sure to consult with our sales representative or engineer whenever the products are to be used in conditions not listed above.

● Rating

The component may be damaged if excessive mechanical stress is applied.

● Handling

1. Do not use this product with bend. The component may be damaged if excess mechanical stress is applied to it mounted on the printed circuit board.
2. Do not apply any type of reflow soldering on the component.
3. Do not clean or wash the component as it is not hermetically sealed.
4. Do not use strong acidity flux, more than 0.2wt% chlorine content, in flow soldering.
5. In case of overcoating the component, conditions such as material of resin, cure temperature, and so on should be evaluated well.
6. Accurate test circuit values are required to measure electrical characteristics. It may be a cause of miscorrelation if there is any deviation, especially stray capacitance, from the test circuit in the specification.
7. For safety purposes, avoid applying a direct current between the terminals.

Notice

■ CERAFIL® 4.5-6.5MHz Chip Type SFSKA Series

● Soldering and Mounting

1. Standard Reflow Soldering Conditions

(1) Reflow

Filter is soldered twice within the following temperature conditions.



(2) Soldering Iron

Filter is soldered at $+350\pm 5^{\circ}\text{C}$ for 3.0 ± 0.5 seconds. The soldering iron should not touch the filter while soldering.

(3) Conditions for Placement Machines

The component is recommended for use with placement machines that employ optical placement capabilities. Damage may result from excessive mechanical force. Please make sure that you have evaluated by using placement machines before going into mass production. Do not use placement machines that utilize mechanical positioning. Please contact Murata for details beforehand.

(4) Other

- The component may be damaged if excess mechanical stress is applied to it mounted on the printed circuit board.
- Design layout of components on the PC board to minimize the stress imposed on the warp or flexure of the board.
- After installing chips, if solder is excessively applied to the circuit board, mechanical stress will cause destruction resistance characteristics to degrade. To prevent this, be extremely careful in determining shape and dimension before designing the circuit board diagram.
- When the positioning claws and pick-up nozzle are worn, the load is applied to the components while positioning is concentrated to one positioning accuracy, etc. Careful checking and maintenance are necessary to prevent unexpected trouble.
- When correcting chips with a soldering iron, the tip of the soldering iron should not directly touch the chip component.



2. Wash

Do not clean or wash the component as it is not hermetically sealed.

Continued on the following page.

Notice

☐ Continued from the preceding page.

3. Coating

In case of overcoating the component, conditions such as material of resin, cure temperature, and so on should be evaluated well.

● Storage and Operating Conditions

1. Product Storage Conditions

Please store the products in room where the temperature/humidity is stable, and avoid places where there are large temperature changes. Please store the products under the following conditions:

Temperature: -10 to +40°C

Humidity: 15 to 85% R.H.

2. Expiration Date on Storage

Expiration date (Shelf life) of the products is six months after delivery under the conditions of a sealed and unopened package. Please use the products within six months after delivery. If you store the products for a long time (more than six months), use carefully because the products may be degraded in solderability due to storage under poor conditions.

Please confirm solderability and characteristics for the products regularly.

3. Notice on Product Storage

(1) Please do not store the products in a chemical atmosphere (Acids, Alkali, Bases, Organic gas, Sulfides and so on), because quality and solderability may be degraded due to the storage in a chemical atmosphere.

- (2) Please do not put the products directly on the floor without anything under them to avoid damp places and/or dusty places.
- (3) Please do not store the products in the places such as a damp heated place or any place exposed to direct sunlight or excessive vibration.
- (4) Please use the products immediately after package is opened, because quality and solderability may be degraded due to storage under the poor conditions.
- (5) To avoid cracking of ceramic element, please do not drop the products.

4. Other

Please be sure to consult with our sales representative or engineer whenever the products are to be used in conditions not listed above.

● Rating

The component may be damaged if excessive mechanical stress is applied.

● Handling

1. Accurate test circuit values are required to measure electrical characteristics.

Misrelation may be caused if there is any deviation, especially stray capacitance, from the test circuit in the specification.

2. For safety purposes, connect the output of filters to the IF amplifier through a D.C. blocking capacitor. Avoid applying a direct current to the output of ceramic filters.

Notice

■ CERAFIL® 2.3-5.7MHz Chip Type SFSKB Series

● Soldering and Mounting

1. Standard Reflow Soldering Conditions

(1) Reflow

Filter is soldered twice within the following temperature conditions.



(2) Soldering Iron

Filter is soldered at $+350\pm 5^{\circ}\text{C}$ for 3.0 ± 0.5 seconds. The soldering iron should not touch the filter while soldering.

(3) Conditions for Placement Machines

The component is recommended for use with placement machines that employ optical placement capabilities. Damage may result from excessive mechanical force. Please make sure that you have evaluated by using placement machines before going into mass production. Do not use placement machines that utilize mechanical positioning. Please contact Murata for details beforehand.

(4) Other

- The component may be damaged if excess mechanical stress is applied to it mounted on the printed circuit board.
- Design layout of components on the PC board to minimize the stress imposed on the warp or flexure of the board.
- After installing components, if solder is excessively applied to the circuit board, mechanical stress will cause destruction resistance characteristics to degrade. To prevent this, be extremely careful in determining shape and dimension before designing the circuit board diagram.
- When the positioning claws and pick-up nozzle are worn, the load is applied to the components while positioning is concentrated to one positioning accuracy, etc. Careful checking and maintenance are necessary to prevent unexpected trouble.
- When correcting components with a soldering iron, the tip of the soldering iron should not directly touch the component. Depending on the soldering conditions, the effective area of terminations may be reduced. Solder containing Ag should be used to prevent the electrode erosion.
- Do not use strong acidity flux, more than 0.2wt% chlorine content, in reflow soldering.



Continued on the following page. ↗

Notice

☐ Continued from the preceding page.

2. Wash

Do not clean or wash the component as it is not hermetically sealed.

3. Coating

In case of overcoating the component, conditions such as material of resin, cure temperature, and so on should be evaluated well.

● Storage and Operating Conditions

1. Product Storage Conditions

Please store the products in room where the temperature/humidity is stable, and avoid places where there are large temperature changes. Please store the products under the following conditions:

Temperature: -10 to +40°C

Humidity: 15 to 85% R.H.

2. Expiration Date on Storage

Expiration date (Shelf life) of the products is six months after delivery under the conditions of a sealed and unopened package. Please use the products within six months after delivery. If you store the products for a long time (more than six months), use carefully because the products may be degraded in solderability due to storage under poor conditions.

Please confirm solderability and characteristics for the products regularly.

3. Notice on Product Storage

(1) Please do not store the products in a chemical atmosphere (Acids, Alkali, Bases, Organic gas, Sulfides and so on), because quality and solderability may be degraded due to the storage in a chemical atmosphere.

- (2) Please do not put the products directly on the floor without anything under them to avoid damp places and/or dusty places.
- (3) Please do not store the products in the places such as a damp heated place or any place exposed to direct sunlight or excessive vibration.
- (4) Please use the products immediately after package is opened, because quality and solderability may be degraded due to storage under the poor conditions.
- (5) To avoid cracking of ceramic element, please do not drop the products.

4. Other

Please be sure to consult with our sales representative or engineer whenever the products are to be used in conditions not listed above.

● Rating

The component may be damaged if excessive mechanical stress is applied.

● Handling

1. Accurate test circuit values are required to measure electrical characteristics.

Miscorrelation may be caused if there is any deviation, especially stray capacitance, from the test circuit in the specification.

2. For safety purposes, connect the output of filters to the IF amplifier through a D.C. blocking capacitor. Avoid applying a direct current to the output of ceramic filters.

Notice

■ CERAFIL[®] 455kHz Chip Type SFPKA Series

● Soldering and Mounting

1. Standard Reflow Soldering Conditions

(1) Reflow

Filter is soldered twice within the following temperature conditions.



(2) Soldering Iron

Electrode is directly soldered with the tip of soldering iron at $+350\pm 5^{\circ}\text{C}$ for 3.0 ± 0.5 seconds.

(3) Other

Do not use strong acidity flux, more than 0.2wt% chlorine content, in reflow soldering.

2. Wash

(1) Cleaning Solvent

CFC alternatives (HCFC Series), Isopropyl Alcohol (IPA), Water (Demineralized Water), Cleaning Water Solution (Cleanthrough-750H, Pine Alpha 100S), Silicon (Technocare FRW)

(2) Cleaning Conditions

- Immersion Wash
2 minutes max. in above solvent at $+60^{\circ}\text{C}$ max.
- Shower or Rinse Wash
2 minutes max. in above solvent at $+60^{\circ}\text{C}$ max.

(3) Notice

- When components are immersed in solvent, be sure to maintain the temperature of components below the temperature of solvent.
- Please do not use ultrasonic cleaning.
- Total washing time should be 4 minutes maximum.
- Please ensure the component is thoroughly evaluated in your application circuit.
- Please do not use chlorine, petroleum or alkali cleaning solvent.
- If you plan to use any other types of solvents, please consult with Murata or a Murata representative prior to using.

3. Coating

In case of overcoating the component, conditions such as material of resin, cure temperature, and so on should be evaluated well.

Continued on the following page. 

Notice

☐ Continued from the preceding page.

● Storage and Operating Conditions

1. Product Storage Conditions

Please store the products in a room where the temperature/humidity is stable, and avoid places where there are large temperature changes. Please store the products under the following conditions:

Temperature: -10 to +40°C

Humidity: 15 to 85% R.H.

2. Expiration Date on Storage

Expiration date (shelf life) of the products is six months after delivery under the conditions of a sealed and unopened package. Please use the products within six months after delivery. If you store the products for a long time (more than six months), use carefully because solderability may be degraded due to storage under poor conditions.

Please confirm solderability and characteristics for the products regularly.

3. Notice on Product Storage

(1) Please do not store the products in a chemical atmosphere (Acids, Alkali, Bases, Organic gas, Sulfides and so on), because quality and solderability may be degraded due to storage in a chemical atmosphere.

● Rating

The component may be damaged if excessive mechanical stress is applied.

● Handling

1. If the component is cleaned, please confirm that the reliability has not been degraded.
2. The components, packed in a moisture-proof bag (dry pack), are sensitive to moisture. The following treatment is required before applying reflow soldering, to avoid package cracks or reliability degradation caused by thermal stress. When unpacked, store the component in an atmosphere of below 25°C and below 65%R.H., and solder within 48 hours.

(2) Please do not put the products directly on the floor without anything under them to avoid damp places and/or dusty places.

(3) Please do not store the products in places such as a damp heated place or any place exposed to direct sunlight or excessive vibration.

(4) Please use the products immediately after package is opened, because quality and solderability may be degraded due to storage under poor conditions.

(5) To avoid cracking of ceramic element, please do not drop the products.

4. Other

Please be sure to consult with our sales representative or engineer whenever the products are to be used in conditions not listed above.

3. For safety purposes, connect the output of filters to the IF amplifier through a D.C. blocking capacitor. Avoid applying a direct current to the output of ceramic filters.

Notice

■ CERAFIL® 455kHz Lead Type SFPLA/CFWLA/CFULA Series

● Soldering and Mounting

The component cannot withstand washing.

● Storage and Operating Conditions

1. Product Storage Conditions

Please store the products in a room where the temperature/humidity is stable, and avoid places where there are large temperature changes. Please store the products under the following conditions:

Temperature: -10 to +40°C

Humidity: 15 to 85% R.H.

2. Expiration Date on Storage

Expiration date (shelf life) of the products is six months after delivery under the conditions of a sealed and unopened package. Please use the products within six months after delivery. If you store the products for a long time (more than six months), use carefully because solderability may be degraded due to storage under poor conditions.

Please confirm solderability and characteristics for the products regularly.

3. Notice on Product Storage

(1) Please do not store the products in a chemical atmosphere (Acids, Alkali, Bases, Organic gas, Sulfides and so on), because quality and solderability may be degraded due to storage in a chemical atmosphere.

(2) Please do not put the products directly on the floor without anything under them to avoid damp places and/or dusty places.

(3) Please do not store the products in places such as a damp heated place or any place exposed to direct sunlight or excessive vibration.

(4) Please use the products immediately after package is opened, because quality and solderability may be degraded due to storage under poor conditions.

(5) To avoid cracking of ceramic element, please do not drop the products.

4. Other

Please be sure to consult with our sales representative or engineer whenever the products are to be used in conditions not listed above.

● Rating

The component may be damaged if excessive mechanical stress is applied.

● Handling

1. Do not use this product with bend. The component may be damaged if excessive mechanical stress is applied to it mounted on the printed circuit board.

2. All kinds of reflow soldering must not be applied on the component.

3. Do not clean or wash the component as it is not hermetically sealed.

4. Do not use strong acidity flux, more than 0.2wt% chlorine content, in flow soldering.

5. Conformal coating of the component is not acceptable due to non-sealed construction.

6. Accurate test circuit values are required to measure electrical characteristics. Misrelation may be caused if there is any deviation, especially stray capacitance, from the test circuit in the specification.

7. For safety purposes, connect the output of filters to the IF amplifier through a D.C. blocking capacitor. Avoid applying a direct current to the output of ceramic filters.

Notice

■ **Ceramic Trap 4.5-6.5MHz Chip Type TPSKA Series**

● **Soldering and Mounting**

1. **Standard Reflow Soldering Conditions**

(1) **Reflow**

Filter is soldered twice within the following temperature conditions.



(2) **Soldering Iron**

Filter is soldered at $+350\pm 5^{\circ}\text{C}$ for 3.0 ± 0.5 seconds. The soldering iron should not touch the filter while soldering.

(3) **Conditions for Placement Machines**

The component is recommended for use with placement machines that employ optical placement capabilities. Damage may result from excessive mechanical force. Please make sure that you have evaluated by using placement machines before going into mass production. Do not use placement machines that utilize mechanical positioning. Please contact Murata for details beforehand.

(4) **Other**

- (a) The component may be damaged if excess mechanical stress is applied to it mounted on the printed circuit board.
- (b) Design layout of components on the PC board to minimize the stress imposed on the warp or flexure of the board.
- (c) After installing chips, if solder is excessively applied to the circuit board, mechanical stress will cause destruction resistance characteristics to degrade. To prevent this, be extremely careful in determining shape and dimension before designing the circuit board diagram.
- (d) When the positioning claws and pick-up nozzle are worn, the load is applied to the components while positioning is concentrated to one positioning accuracy, etc. Careful checking and maintenance are necessary to prevent unexpected trouble.
- (e) When correcting chips with a soldering iron, the tip of the soldering iron should not directly touch the chip component.



2. **Wash**

Do not clean or wash the component as it is not hermetically sealed.

Continued on the following page. ↗

Notice

☐ Continued from the preceding page.

3. Coating

In case of overcoating the component, conditions such as material of resin, cure temperature, and so on should be evaluated well.

● Storage and Operating Conditions

1. Product Storage Conditions

Please store the products in room where the temperature/humidity is stable, and avoid places where there are large temperature changes. Please store the products under the following conditions:

Temperature: -10 to +40°C

Humidity: 15 to 85% R.H.

2. Expiration Date on Storage

Expiration date (Shelf life) of the products is six months after delivery under the conditions of a sealed and unopened package. Please use the products within six months after delivery. If you store the products for a long time (more than six months), use carefully because the products may be degraded in solderability due to storage under poor conditions.

Please confirm solderability and characteristics for the products regularly.

3. Notice on Product Storage

(1) Please do not store the products in a chemical atmosphere (Acids, Alkali, Bases, Organic gas, Sulfides and so on), because quality and solderability may be degraded due to the storage in a chemical atmosphere.

- (2) Please do not put the products directly on the floor without anything under them to avoid damp places and/or dusty places.
- (3) Please do not store the products in the places such as a damp heated place or any place exposed to direct sunlight or excessive vibration.
- (4) Please use the products immediately after package is opened, because quality and solderability may be degraded due to storage under the poor conditions.
- (5) To avoid cracking of ceramic element, please do not drop the products.

4. Other

Please be sure to consult with our sales representative or engineer whenever the products are to be used in conditions not listed above.

● Rating

The component may be damaged if excessive mechanical stress is applied.

● Handling

1. Accurate test circuit values are required to measure electrical characteristics.

Misrelation may be caused if there is any deviation, especially stray capacitance, from the test circuit in the specification.

2. For safety purposes, connect the output of filters to the IF amplifier through a D.C. blocking capacitor. Avoid applying a direct current to the output of ceramic filters.

Notice

■ **Ceramic Discriminator 10.7MHz Chip Type CDSCB Series**

● **Soldering and Mounting**

1. **Standard Reflow Soldering Conditions**

(1) **Reflow**

Filter is soldered twice within the following temperature conditions.



(2) **Soldering Iron**

Filter is soldered at $+300\pm 5^{\circ}\text{C}$ for 3.0 ± 0.5 seconds. The soldering iron should not touch the filter while soldering.

(3) **Conditions for Placement Machines**

The component is recommended for use with placement machines that employ optical placement capabilities. The component might be damaged by excessive mechanical force. Please make sure that you have evaluated by using placement machines before going into mass production. Do not use placement machines that utilize mechanical positioning. Please contact Murata for details beforehand.

(4) **Other**

- (a) The component may be damaged if excess mechanical stress is applied to it mounted on the printed circuit board.
- (b) Design layout of components on the PC board to minimize the stress imposed on the warp or flexure of the board.
- (c) After installing components, if solder is excessively applied to the circuit board, mechanical stress will cause destruction resistance characteristics to degrade. To prevent this, be extremely careful in determining shape and dimension before designing the circuit board diagram.
- (d) When the positioning claws and pick-up nozzle are worn, the load is applied to the components while positioning is concentrated on positioning accuracy, etc. Careful checking and maintenance are necessary to prevent unexpected trouble.
- (e) When correcting components with a soldering iron, the tip of the soldering iron should not directly touch the component. Depending on the soldering conditions, the effective area of terminations may be reduced. Solder containing Ag should be used to prevent electrode erosion.



Continued on the following page. ↗

Notice

☐ Continued from the preceding page.

2. Wash

Do not clean or wash the component as it is not hermetically sealed.

3. Coating

In case of overcoating the component, conditions such as material of resin, cure temperature, and so on should be evaluated well.

● Storage and Operating Conditions

1. Product Storage Conditions

Please store the products in a room where the temperature/humidity is stable, and avoid places where there are large temperature changes. Please store the products under the following conditions:

Temperature: -10 to +40°C

Humidity: 15 to 85% R.H.

2. Expiration Date on Storage

Expiration date (shelf life) of the products is six months after delivery under the conditions of a sealed and unopened package. Please use the products within six months after delivery. If you store the products for a long time (more than six months), use carefully because solderability may be degraded due to storage under poor conditions.

Please confirm solderability and characteristics for the products regularly.

3. Notice on Product Storage

(1) Please do not store the products in a chemical atmosphere (Acids, Alkali, Bases, Organic gas, Sulfides and so on), because quality and solderability may be degraded due to storage in a chemical atmosphere.

(2) Please do not put the products directly on the floor without anything under them to avoid damp places and/or dusty places.

(3) Please do not store the products in places such as a damp heated place or any place exposed to direct sunlight or excessive vibration.

(4) Please use the products immediately after package is opened, because quality and solderability may be degraded due to storage under poor conditions.

(5) To avoid cracking of ceramic element, please do not drop the products.

4. Other

Please be sure to consult with our sales representative or engineer whenever the products are to be used in conditions not listed above.

● Rating

The component may be damaged if excessive mechanical stress is applied.

● Handling

1. Accurate test circuit values are required to measure electrical characteristics. Miscorrelation may be caused if there is any deviation, especially stray capacitance, from the test circuit in the specification.

2. For safety purposes, avoid applying a direct current between the terminals.

Packaging

Minimum Quantity

	Taping		Ammo Pack	Bulk	Magazine	Box
	ø330mm	ø180mm				
CERAFIL®<10.7MHz>						
	SFECF		2,000			
	SFECV/SFECK		2,000			
	SFELF		1,500	500		
CERAFIL®<2.3-6.5MHz>						
	SFSKA	3,000				
	SFSKB	3,000				
CERAFIL®<455kHz>						
	CFULA					200
	CFWLA	1,000			50	150
	SFPLA	1,000			50	200
Ceramic Traps<4.5-6.5MHz>						
	TPSKA	3,000				
Ceramic Discriminators<10.7MHz>						
	CDSCB		2,000			

CERAFIL® 10.7MHz Chip Type SFECF Series

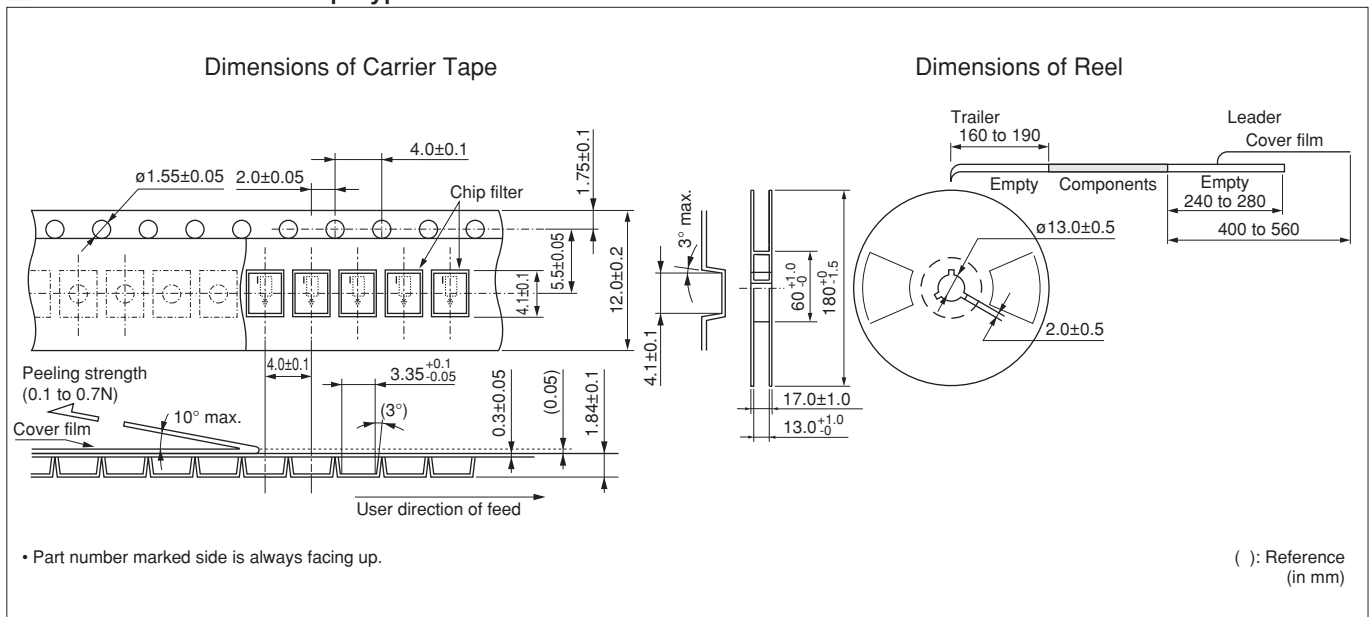

CERAFIL® 10.7MHz Chip Type SFECV/SFECK Series

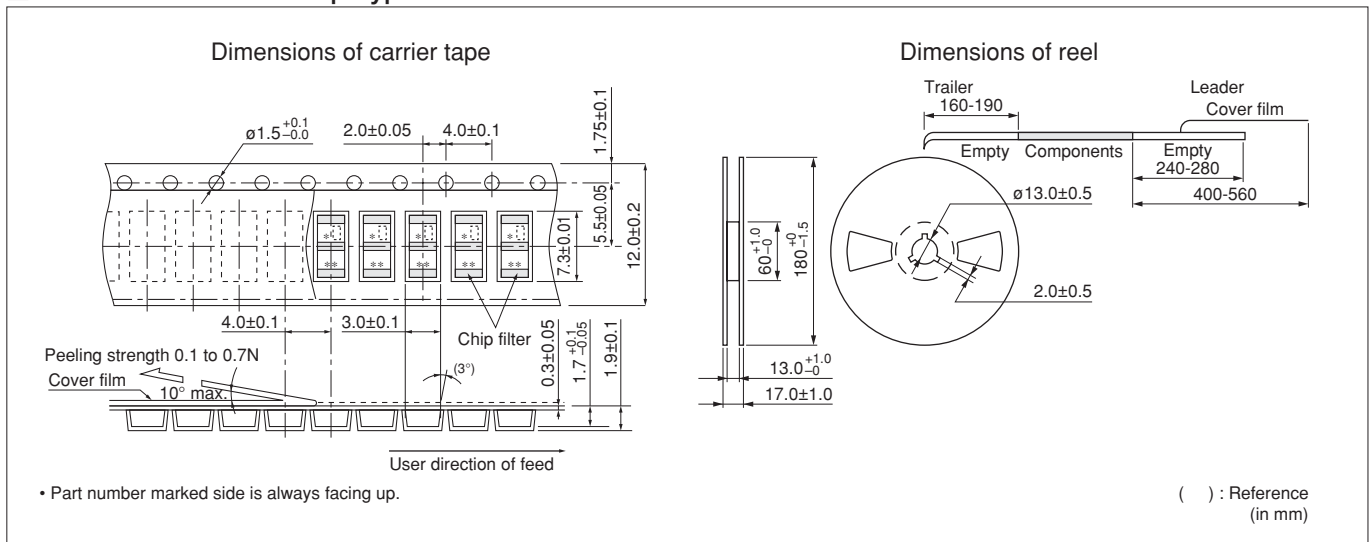

Continued on the following page. ↗

Packaging

Continued from the preceding page.

■ CERAFIL® 10.7MHz Lead Type SFELF Series



Item	Code	Dimensions	Tolerance	Remarks
Lead length under the hold down tape	L1	3.0 min.	-	
Length of cut-off	L2	2.0 max.	-	To distinguish the direction
Pitch of components	P	12.7	±0.5	
Pitch of sprocket hole (1)	P0	12.7	±0.2	
Length from hole center to lead	P1	3.85	±0.5	
Length from hole center to component center	P2	6.35	±0.5	
Lead spacing (1)	F	5.0	+0.5 -0.2	
Lead spacing (2)	F1	2.5	±0.2	
Slant forward or backward	dh	0	±1.0	
Slant to the left or right	dS1	0	±1.0	
Width of carrier tape	W	18.0	±0.5	
Width of hold down tape	W0	6.0 min.	-	
Position of sprocket hole	W1	9.0	±0.5	
Gap of hold down tape and carrier tape	W2	0	+0.5 -0	Hold down tape doesn't exceed the carrier tape
Distance between the center of sprocket hole and lead stopper	Ho	18.0	±0.5	
Diameter of sprocket hole	Do	ø4.0	±0.2	
Total tape thickness	t	0.6	±0.2	
Pitch of sprocket hole (2)	P020	254.0	±1.5	The pitch of 20 sprocket holes

(in mm)

Continued on the following page.

Packaging

Continued from the preceding page.

■ CERAFIL® 4.5-6.5MHz Chip Type SFSKA Series



■ CERAFIL® 2.3-5.7MHz Chip Type SFSKB Series



■ CERAFIL® 455kHz Chip Type SFPKA Series



Continued on the following page. ↗

Packaging

☐ Continued from the preceding page.

■ CERAFIL® 455kHz Lead Type SFPLA Series

Standard of Magazine Cassette

1. Putting CERAFIL® into Magazine

A magazine should contain 50pcs of CERAFIL®, with ground terminals all facing toward the "Murata" mark on a magazine, and be closed with exclusive stoppers at both ends. Above should be the minimum packaging unit.

2. Quality of Magazine

- (1) Transparent so that input / output direction is visually recognizable.
- (2) With an angle of 35° CERAFIL® should slip down smoothly.
- (3) Antistatic finish
- (4) Recycling

Note: Magazines should be sent back for recycling.
 (Therefore, empty magazines should not be damaged.)

3. Dimensions of Magazine Cassette

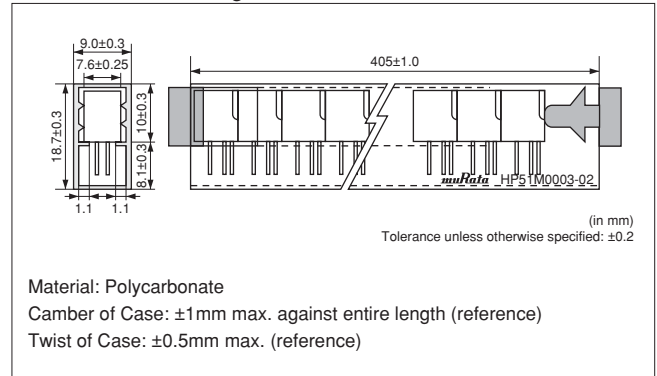

■ CERAFIL® 455kHz Lead Type CFWLA Series

Standard of Magazine Cassette

1. Putting CERAFIL® into Magazine

A magazine should contain 50pcs of CERAFIL®, with ground terminals all facing toward the "Murata" mark on a magazine, and be closed with exclusive stoppers at both ends. Above should be the minimum packaging unit.

2. Quality of Magazine

- (1) Transparent so that input / output direction is visually recognizable.
- (2) With an angle of 35° CERAFIL® should slip down smoothly.
- (3) Antistatic finish
- (4) Recycling

Note: Magazines should be sent back for recycling.
 (Therefore, empty magazines should not be damaged.)

4. Dimensions of Magazine Cassette

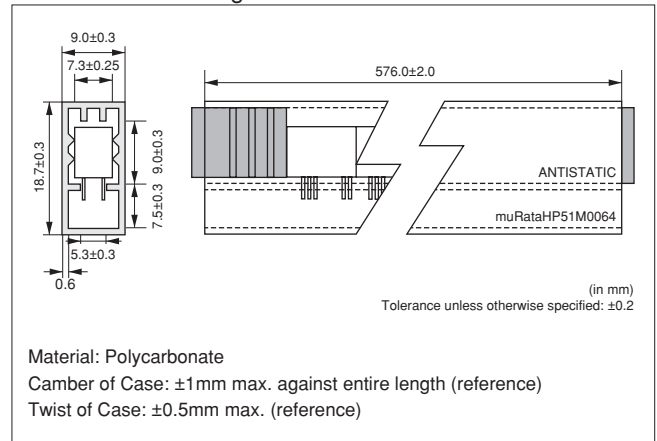

3. Magazine should be packaged in a cardboard box.
 MURATA model name, quantity and outgoing inspection number should be indicated on the box.
 Cardboard box may contain maximum 33 magazines
 (1,650 pieces of filter).

Continued on the following page. ☐

Packaging

Continued from the preceding page.

■ Ceramic Trap 4.5-6.5MHz Chip Type TPSKA Series



■ Ceramic Discriminator 10.7MHz Chip Type CDSCB Series



Part Number Index

CDSCB	Chip Ceramic Discriminators for FM	p47
CFULA	Ceramic Filters (CERAFIL®) for AM	p42
CFWLA	Ceramic Filters (CERAFIL®) for AM	p40, 42
SFECF	Chip Ceramic Filters (CERAFIL®) for FM	p5-6
SFECK	Chip Ceramic Filters (CERAFIL®) for FM	p11
SFECV	Chip Ceramic Filters (CERAFIL®) for FM	p11
SFELF	Ceramic Filters (CERAFIL®) for FM	p14, 17, 20-21, 23, 25, 27
SFPKA	Chip Ceramic Filters (CERAFIL®) for AM	p38
SFPLA	Ceramic Filters (CERAFIL®) for AM	p40, 42
SFSKA	Chip Ceramic Filters (CERAFIL®) for TV/VCR	p31
SFSKB	Chip Ceramic Filters (CERAFIL®) for TV/VCR	p34
TPSKA	Chip Ceramic Traps	p45

⚠Note:

1. Export Control

<For customers outside Japan>

No Murata products should be used or sold, through any channels, for use in the design, development, production, utilization, maintenance or operation of, or otherwise contribution to (1) any weapons (Weapons of Mass Destruction [nuclear, chemical or biological weapons or missiles] or conventional weapons) or (2) goods or systems specially designed or intended for military end-use or utilization by military end-users.

<For customers in Japan>

For products which are controlled items subject to the "Foreign Exchange and Foreign Trade Law" of Japan, the export license specified by the law is required for export.

2. Please contact our sales representatives or product engineers before using the products in this catalog for the applications listed below, which require especially high reliability for the prevention of defects which might directly damage a third party's life, body or property, or when one of our products is intended for use in applications other than those specified in this catalog.

- | | |
|-----------------------------|--|
| ① Aircraft equipment | ② Aerospace equipment |
| ③ Undersea equipment | ④ Power plant equipment |
| ⑤ Medical equipment | ⑥ Transportation equipment (vehicles, trains, ships, etc.) |
| ⑦ Traffic signal equipment | ⑧ Disaster prevention / crime prevention equipment |
| ⑨ Data-processing equipment | ⑩ Application of similar complexity and/or reliability requirements to the applications listed above |

3. Product specifications in this catalog are as of July 2012. They are subject to change or our products in it may be discontinued without advance notice. Please check with our sales representatives or product engineers before ordering. If there are any questions, please contact our sales representatives or product engineers.
4. Please read rating and ⚠CAUTION (for storage, operating, rating, soldering, mounting and handling) in this catalog to prevent smoking and/or burning, etc.
5. This catalog has only typical specifications. Therefore, please approve our product specifications or transact the approval sheet for product specifications before ordering.
6. Please note that unless otherwise specified, we shall assume no responsibility whatsoever for any conflict or dispute that may occur in connection with the effect of our and/or a third party's intellectual property rights and other related rights in consideration of your use of our products and/or information described or contained in our catalogs. In this connection, no representation shall be made to the effect that any third parties are authorized to use the rights mentioned above under licenses without our consent.
7. No ozone depleting substances (ODS) under the Montreal Protocol are used in our manufacturing process.



Компания «ЭлектроПласт» предлагает заключение долгосрочных отношений при поставках импортных электронных компонентов на взаимовыгодных условиях!

Наши преимущества:

- Оперативные поставки широкого спектра электронных компонентов отечественного и импортного производства напрямую от производителей и с крупнейших мировых складов;
- Поставка более 17-ти миллионов наименований электронных компонентов;
- Поставка сложных, дефицитных, либо снятых с производства позиций;
- Оперативные сроки поставки под заказ (от 5 рабочих дней);
- Экспресс доставка в любую точку России;
- Техническая поддержка проекта, помощь в подборе аналогов, поставка прототипов;
- Система менеджмента качества сертифицирована по Международному стандарту ISO 9001;
- Лицензия ФСБ на осуществление работ с использованием сведений, составляющих государственную тайну;
- Поставка специализированных компонентов (Xilinx, Altera, Analog Devices, Intersil, Interpoint, Microsemi, Aeroflex, Peregrine, Syfer, Eurofarad, Texas Instrument, Miteq, Cobham, E2V, MA-COM, Hittite, Mini-Circuits, General Dynamics и др.);

Помимо этого, одним из направлений компании «ЭлектроПласт» является направление «Источники питания». Мы предлагаем Вам помощь Конструкторского отдела:

- Подбор оптимального решения, техническое обоснование при выборе компонента;
- Подбор аналогов;
- Консультации по применению компонента;
- Поставка образцов и прототипов;
- Техническая поддержка проекта;
- Защита от снятия компонента с производства.



Как с нами связаться

Телефон: 8 (812) 309 58 32 (многоканальный)

Факс: 8 (812) 320-02-42

Электронная почта: org@eplast1.ru

Адрес: 198099, г. Санкт-Петербург, ул. Калинина, дом 2, корпус 4, литера А.