

EAO – Your Expert Partner for  
Human Machine Interfaces



## EAO Product Information

Series 19





|                               |    |
|-------------------------------|----|
| Description .....             | 3  |
| Product Assembly .....        | 4  |
| Devices raised mounting ..... | 5  |
| Accessories.....              | 6  |
| Technical Data.....           | 9  |
| Application guidelines.....   | 11 |
| Drawings.....                 | 12 |
| Index.....                    | 15 |

### Product Information

#### General notes

The series contains indicators and illuminated pushbuttons with maintained and momentary action and one contact which may be normally closed or normally open (snap-action element for closing). The illuminated pushbuttons are fitted with snap-action or low-level switching systems.

The front dimensions are 9 x 9 mm or 9 mm dia.

#### Mounting

Mounting from the front through the mounting hole is assured even when the wiring has already been attached.

The units are equipped with soldering/plug-in terminals.

#### Lenses

The flat lenses, made of polycarbonate, are obtainable in various colours. The transparent lens is available with translucent or transparent support.

#### Marking

A limited amount of marking can be provided.

#### Illumination

Perfect illumination of the different coloured lenses is assured by filament lamps Bi-Pin T1 longlife (6 ... 24 V) or LED Bi-Pin T1. LED are available in the colours white, red, yellow, orange and green.

Luminosity and wave length scattering caused by the technology used in the LED manufacturing processes may lead to visual differences in our products.

#### Position indication

The status of a maintained action switch can be determined by the position of the lens.

### Specimen order

#### Indicator :

- Indicator actuator, 9 mm dia., soldering terminal 19-030.005

#### Essential accessories :

- Lens plastic blue, transparent, flush, 9 mm dia. 19-931.6
- Single-LED, T1 Bi-Pin, 3.6 VDC, weiss 10-2603.3179C

*We reserve the right to modify technical data  
All dimensions in mm*

## Indicator, raised mounting

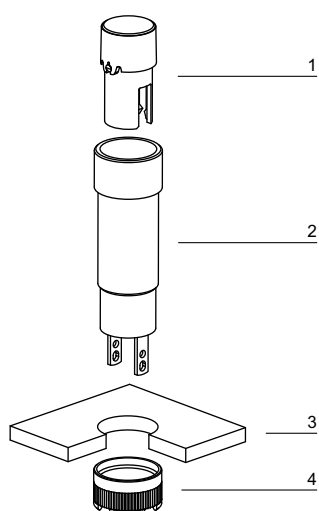

- 1 Lens
- 2 Switch housing
- 3 Front plate
- 4 Fixing nut

## Pushbutton illuminative, raised mounting

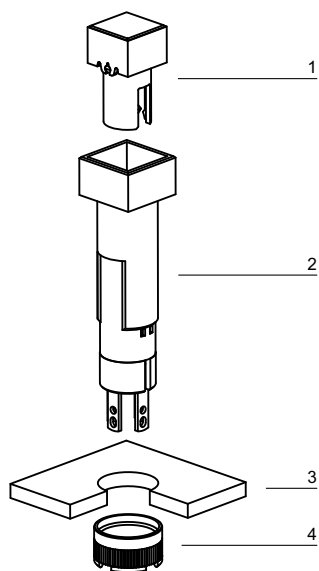



- 1 Lens
- 2 Switch housing
- 3 Front plate
- 4 Fixing nut

## Indicator actuator



### Essential Accessories:

-  Lens page 6
-  Single-LED page 7

|   | Front protection | Terminals | 9 x 9 mm Typ-Nr.  | Ø 9 mm Typ-Nr.    | Component layout | Mounting dimensions | Technical drawing | Circuit drawing |       |
|---|------------------|-----------|-------------------|-------------------|------------------|---------------------|-------------------|-----------------|-------|
| <b>Indicator actuator</b><br>Mounting depth : 25 mm | IP 40            | S2        | <b>19-050.005</b> | <b>19-030.005</b> | 1                | 1                   | 1                 | 1               | 0.001 |
| Mounting depth : 33 mm                              | IP 40            | S2        | <b>19-051.005</b> | <b>19-031.005</b> | 1                | 1                   | 3                 | 1               | 0.002 |



Terminals: S2 = Soldering terminal (also pluggable 2.0 x 0.5 mm)

Component layout from page 12, Mounting dimensions from page 12, Technical drawing from page 13, Circuit drawing from page 14

## Illuminated pushbutton actuator



### Essential Accessories:

-  Lens page 6
-  Single-LED page 7

|  | Front protection | Switching system | Contact material | Contacts | Switching action | Terminals | 9 x 9 mm Typ-Nr.  | Ø 9 mm Typ-Nr.    | Component layout | Mounting dimensions | Technical drawing | Circuit drawing |       |
|--|------------------|------------------|------------------|----------|------------------|-----------|-------------------|-------------------|------------------|---------------------|-------------------|-----------------|-------|
| <b>Illuminated pushbutton actuator</b> | IP 40            | LL               | Au               | 1 NC     | MA               | S2        | <b>19-482.035</b> | <b>19-472.035</b> | 2                | 1                   | 2                 | 2               | 0.002 |
|  |                  |                  |                  |          | M                | S2        | <b>19-452.035</b> | <b>19-432.035</b> | 2                | 1                   | 2                 | 4               | 0.002 |
|  |                  |                  |                  | 1 NO     | MA               | S2        | <b>19-481.035</b> | <b>19-471.035</b> | 2                | 1                   | 2                 | 3               | 0.002 |
|  |                  |                  |                  |          | M                | S2        | <b>19-451.035</b> | <b>19-431.035</b> | 2                | 1                   | 2                 | 5               | 0.002 |
|  |                  | SA               | Au               | 1 NO     | MA               | S2        | <b>19-289.035</b> | <b>19-279.035</b> | 2                | 1                   | 2                 | 3               | 0.002 |
|  |                  |                  |                  |          | M                | S2        | <b>19-159.035</b> | <b>19-139.035</b> | 2                | 1                   | 2                 | 5               | 0.002 |
|  |                  |                  | Ag               | 1 NO     | MA               | S2        | <b>19-289.015</b> | <b>19-279.015</b> | 2                | 1                   | 2                 | 3               | 0.002 |
|  |                  |                  |                  |          | M                | S2        | <b>19-159.015</b> | <b>19-139.015</b> | 2                | 1                   | 2                 | 5               | 0.002 |

Switching system: LL = Low level switching element, SA = Snap-action switching element

Contact material: Au = Gold, Ag = Silver

Contacts: NC = Normally closed, NO = Normally open

Switching action: MA = Maintained action, M = Momentary action

Terminals: S2 = Soldering terminal (also pluggable 2.0 x 0.5 mm)

Component layout from page 12, Mounting dimensions from page 12, Technical drawing from page 13, Circuit drawing from page 14

## Front

### Lens

|  | Lens                                 | ∅ 9 x 9 mm<br>Typ-Nr. | ∅ 9 mm<br>Typ-Nr. |  |
|--|--------------------------------------|-----------------------|-------------------|---|
| <b>Lens</b><br>illuminative, holder translucent                          | Plastic flush transparent blue       | <b>19-951.6</b>       | <b>19-931.6</b>   | 0.001   |
|  | Plastic flush transparent green      | <b>19-951.5</b>       | <b>19-931.5</b>   | 0.001   |
|  | Plastic flush transparent red        | <b>19-951.2</b>       | <b>19-931.2</b>   | 0.001   |
|  | Plastic flush transparent white      | <b>19-951.9</b>       | <b>19-931.9</b>   | 0.001   |
|  | Plastic flush transparent yellow     | <b>19-951.4</b>       | <b>19-931.4</b>   | 0.001   |
| illuminative<br>(not recommended for film insert), holder<br>transparent | Plastic flush transparent blue       | <b>19-952.6</b>       | <b>19-932.6</b>   | 0.001   |
|  | Plastic flush transparent colourless | <b>19-952.7</b>       | <b>19-932.7</b>   | 0.001   |
|  | Plastic flush transparent green      | <b>19-952.5</b>       | <b>19-932.5</b>   | 0.001   |
|  | Plastic flush transparent red        | <b>19-952.2</b>       | <b>19-932.2</b>   | 0.001   |
|  | Plastic flush transparent yellow     | <b>19-952.4</b>       | <b>19-932.4</b>   | 0.001   |
| non-illuminative   | Plastic flush opaque black           | <b>19-951.0</b>       | <b>19-931.0</b>   | 0.001   |
|  | Plastic flush opaque grey            | <b>19-951.8</b>       | <b>19-931.8</b>   | 0.001   |



### Blind plug

|                   | Blind plug    | ∅ 9 x 9 mm<br>Typ-Nr. | ∅ 9 mm<br>Typ-Nr. | Mounting dimensions |  |
|-------------------|---------------|-----------------------|-------------------|---------------------|---|
| <b>Blind plug</b> | Plastic black | <b>19-948.0</b>       | <b>19-949.0</b>   | 1                   | 0.001   |



Mounting dimensions from page 12

## Backside

### PCB plug-in base

|                                       | Terminals | Typ-Nr.       | Component layout | Technical drawing |  |
|---------------------------------------|-----------|---------------|------------------|-------------------|---|
| <b>PCB plug-in base</b><br>Pins axial | P         | <b>19-940</b> | 3                | 4                 | 0.001   |
| Pins bent at right-angles             | P         | <b>19-941</b> | 4                | 5                 | 0.001   |



Terminals: P = PCB terminal

Component layout from page 12, Technical drawing from page 13



## Flat receptacle

|  | Typ-Nr.       |  |
|--|---------------|---|
| <b>Flat receptacle</b><br>2.0 x 0.5 mm | <b>31-945</b> | 0.001   |



## Insulation sleeve

|  | Typ-Nr.       |  |
|--|---------------|---|
| <b>Insulation sleeve</b><br>for Flat receptacle 31-945 | <b>31-928</b> | 0.001   |



## Illumination

### Filament lamp

|  | Socket    | Operating voltage/-current | Typ-Nr.             |  |
|--|-----------|----------------------------|---------------------|---|
| <b>Filament lamp</b><br>max. PIN length 5 mm | T1 Bi-Pin | 12 VAC/DC, 25 mA           | <b>10-1609.1199</b> | 0.001   |
|  |           | 24 VAC/DC, 20 mA           | <b>10-1612.1179</b> | 0.001   |
|  |           | 6 VAC/DC, 70 mA            | <b>10-1606.1309</b> | 0.001   |



### Single-LED

|   | Socket    | Light colour | Operating voltage/-current | Typ-Nr.              |  |
|---|-----------|--------------|----------------------------|----------------------|---|
| <b>Single-LED</b><br>max. PIN length 8 mm | T1 Bi-Pin | green        | 2.2 VDC, 20 mA             | <b>10-2602.3175C</b> | 0.001   |
|   |           | red          | 2.2 VDC, 20 mA             | <b>10-2602.3172C</b> | 0.001   |
|   |           | white        | 3.6 VDC, 20 mA             | <b>10-2603.3179C</b> | 0.001   |
|   |           | yellow       | 2.2 VDC, 20 mA             | <b>10-2602.3174C</b> | 0.001   |



### Multi-LED

|  | Socket    | Light colour | Operating voltage/-current | Typ-Nr.              |  |
|--|-----------|--------------|----------------------------|----------------------|---|
| <b>Multi-LED</b><br>max. PIN length 5 mm | T1 Bi-Pin | green        | 28 VDC, 12 mA              | <b>10-4613.3105B</b> | 0.001   |
|  |           | orange       | 28 VDC, 12 mA              | <b>10-4613.3103B</b> | 0.001   |
|  |           | red          | 28 VDC, 12 mA              | <b>10-4613.3102B</b> | 0.001   |
|  |           | yellow       | 28 VDC, 12 mA              | <b>10-4613.3104B</b> | 0.001   |



## Assembling

### Fixing nut

|                                     | Typ-Nr.       |  kg |
|-------------------------------------|---------------|--|
| <b>Fixing nut</b><br>Ø 9/M8 x 13 mm | <b>19-991</b> | 0.001  |



### Dressing tool

|  | Typ-Nr.       |  kg |
|--|---------------|--|
| <b>Dressing tool</b><br>for aligning buttons | <b>19-906</b> | 0.011  |



### Lens remover

|                     | Typ-Nr.       |  kg |
|---------------------|---------------|--|
| <b>Lens remover</b> | <b>19-910</b> | 0.002  |



### Lamp remover

|                     | Typ-Nr.       |  kg |
|---------------------|---------------|--|
| <b>Lamp remover</b> | <b>11-906</b> | 0.003  |



CAUTION  
A switching process might be released when replacing the Lamp/LED !

### Mounting tool

|  | Typ-Nr.       |  kg |
|--|---------------|--|
| <b>Mounting tool</b><br>for Fixing nut long 19-991 | <b>19-905</b> | 0.011  |



## Actuator with snap-action switching element

### Switching system

Single-break, snap-action switching system.  
1 normally open contact

### Material

#### Material of contact

Gold plated Silver, Silver plated

#### Switch housing

Polyetherimide (PEI), self-extinguishing

#### Actuator housing

Polyphenyleneoxide (PPO), self-extinguishing, colour black

### Mechanical characteristics

#### Terminals

Universal terminal:  
Max. wire diameter 2 x 0.8 mm  
Max. wire cross-section of stranded cable 1 x 0.75 mm<sup>2</sup>

Plug-in terminal: 2.0 x 0.5 mm  
For these terminals we can also supply a plug-in base which, when soldered on to the board, enables the switch to be plugged in.

#### Tightening torque

for fixing nut max. 20 Ncm

#### Actuating force

1.6 N

#### Actuating travel

2.8 mm ±0.2 mm

#### Mechanical lifetime

2 million operations

### Electrical characteristics

#### Switch rating

Silver plated:  
Max. 50 VAC / 72 VDC, 0.8 A or 50 W  
Min. 20 V, 10 mA  
Gold plated:  
Max. 50 VAC / 72 VDC, 100 mA or 5 W  
Min. 100 µV, 50 µA

#### Electric strength

2500 VAC, 50 Hz, 1 min. between all terminals and earth, as per IEC 60512-2-11

### Environmental conditions

#### Storage temperature

-40 °C ... +85 °C

#### Service temperature

without illumination -25 °C ... +65 °C  
with incandescent lamp -25 °C ... +45 °C  
with LED -25 °C ... +65 °C  
for indicators and illuminated pushbuttons mounted as a block, make sure the heat can escape freely

#### Protection degree

IP 40 front side, as per IEC 60529

## Actuator with low level switching element

### Switching system

This low-level switching system was designed for switching low powers in electronic circuits. The switching system assures reliable switching of loads.  
Single-break momentary contact, as normally open or normally closed with 4 independent points of contact.  
Special features are the long life, extremely short rebound time and stable contact resistance.  
1 normally open or 1 normally closed contact.

### Material

#### Material of contact

Gold plated

#### Actuator housing

Polyphenyleneoxide (PPO), self-extinguishing, colour black

### Mechanical characteristics

#### Terminals

Universal terminal:  
Max. wire diameter 2 x 0.8 mm  
Max. wire cross-section of stranded cable 1 x 0.75 mm<sup>2</sup>

Plug-in terminal: 2.0 x 0.5 mm  
For these terminals we can also supply a plug-in base which, when soldered on to the board, enables the switch to be plugged in.

#### Tightening torque

for fixing nut max. 20 Ncm

#### Actuating force

1.8 N ±0.3 N

#### Actuating travel

2.8 mm ±0.2 mm

#### Rebound time

Typ. <100 µs

#### Mechanical lifetime

5 million operations

### Electrical characteristics

#### Contact resistance

≤50 mΩ starting value (initial) as per IEC 60512-2-2b

#### Switch rating

10 µA, 100 µV to 100 mA at 42 VAC/VDC

#### Electric strength

2500 VAC, 50 Hz, 1 min. between all terminals and earth, as per IEC 60512-2-11

### Environmental conditions

#### Storage temperature

-40 °C ... +85 °C

#### Service temperature

without illumination -25 °C ... +65 °C  
with incandescent lamp -25 °C ... +45 °C  
with LED -25 °C ... +65 °C

for indicators and illuminated pushbuttons mounted as a block,  
make sure the heat can escape freely

**Protection degree**

IP 40 front side, as per IEC 60529

**Shock resistance**

(Single impacts, semi-sinusoidal)

15 g for 11 ms, as per IEC 60512-4-3, IEC 60068-2-27

## Suppressor circuits

When switching inductive loads such as relays, DC motors, and DC solenoids, it is always important to absorb surges (e.g. with a diode) to protect the contacts. When these inductive loads are switched off, a counter emf can severely damage switch contacts and greatly shorten lifetime.

Fig. 1 shows an inductive load with a free-wheeling diode connected in parallel. This free-wheeling diode provides a path for the inductor current to flow when the current is interrupted by the switch. Without this free-wheeling diode, the voltage across the coil will be limited only by dielectric breakdown voltages of the circuit or parasitic elements of the coil. This voltage can be kilovolts in amplitude even when nominal circuit voltages are low (e.g. 12 VDC) see Fig. 2.

The free-wheeling diode should be chosen so that the reverse breakdown voltage is greater than the voltage driving the inductive load. The DC blocking voltage ( $V_R$ ) of the free-wheeling diode can be found in the datasheet of a diode. The forward current should be equal or greater than the maximum current flowing through the load.

**To get an efficient protection, the free-wheeling diode must be connected as close as possible to the inductive load!**

Switching with inductive load  
Fig. 1

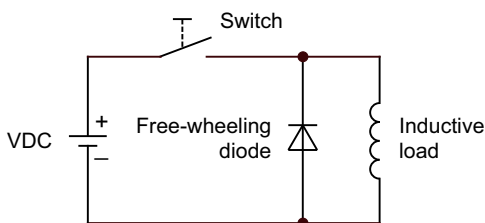

Counter emf  
over load without free-wheeling diode  
Fig. 2

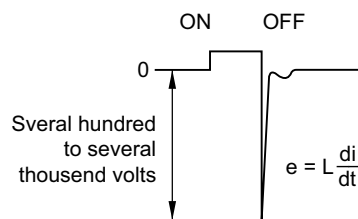

## Component layout

### 1 Indicator actuator page 5

9 x 9 mm      Ø9 mm

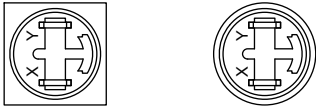

### 2 Illuminated pushbutton actuator page 5

9 x 9 mm      Ø9 mm

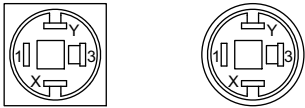

### 3 PCB plug-in base page 6

Drilling plan (element side)  
Through-connection recommended

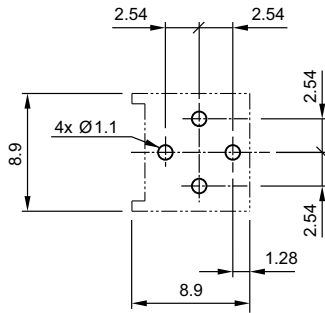

### 4 PCB plug-in base page 6

Drilling plan (element side)  
Through-connection recommended

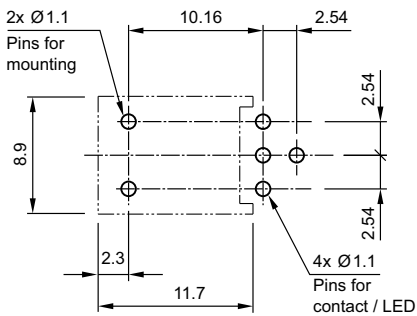

## Mounting dimensions

### 1 Indicator actuator page 5 | Illuminated pushbutton actuator page 5 | Blind plug page 6

9 x 9 mm      Ø9 mm

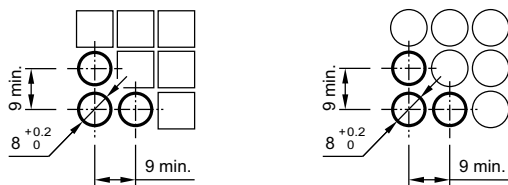

## Technical drawing

1 Indicator actuator page 5

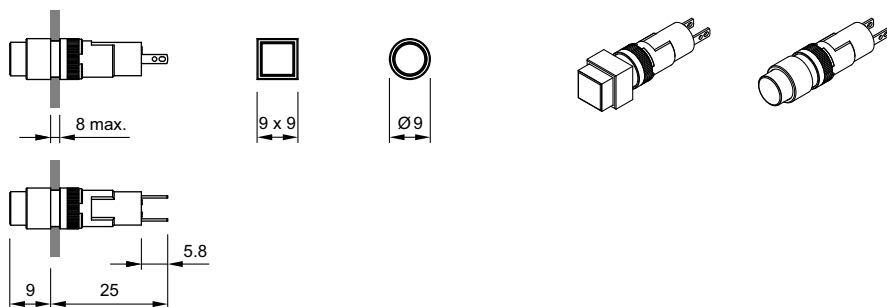

2 Illuminated pushbutton actuator page 5

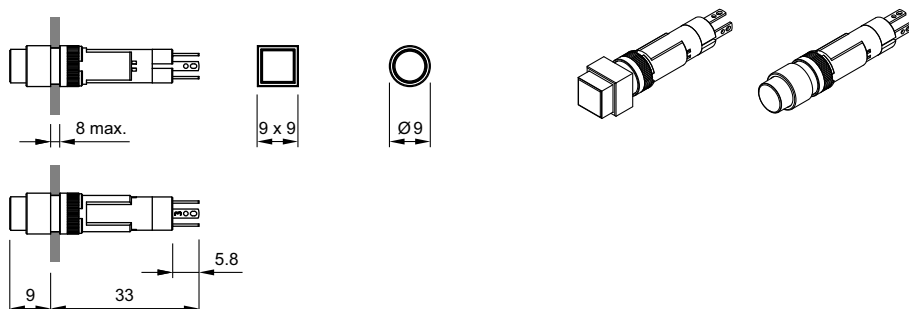

3 Indicator actuator page 5

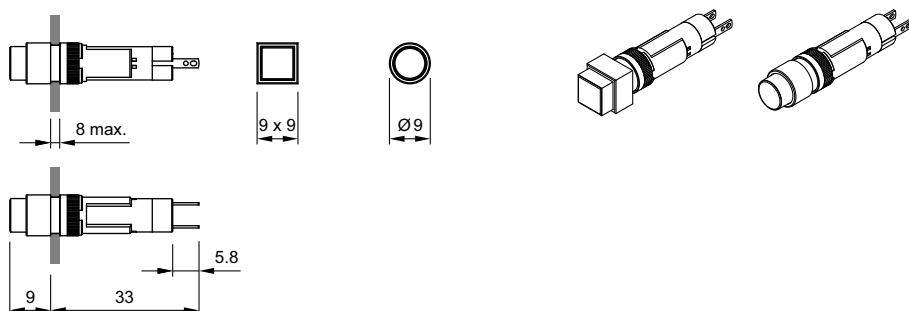

4 PCB plug-in base page 6

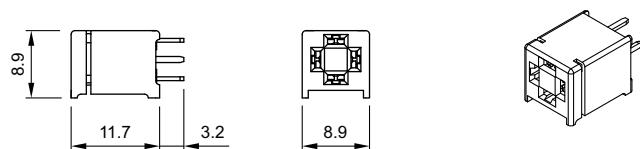

5 PCB plug-in base page 6

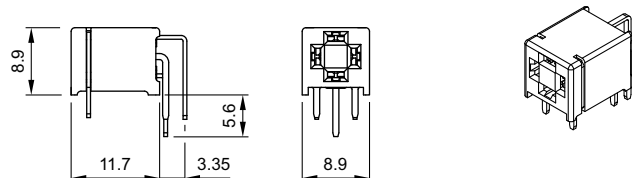

## Circuit drawing

1 Indicator actuator page 5



2 Illuminated pushbutton actuator page 5

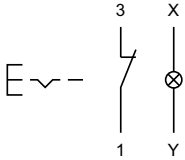

3 Illuminated pushbutton actuator page 5

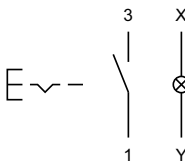

4 Illuminated pushbutton actuator page 5

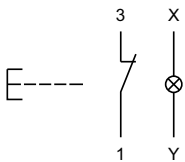

5 Illuminated pushbutton actuator page 5

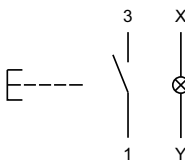



# Index from Typ-Nr.

| Typ-Nr.       | Page | Typ-Nr. | Page | Typ-Nr. | Page |
|---------------|------|---------|------|---------|------|
| 10-1606.1309  | 7    | 19-991  | 8    |         |      |
| 10-1609.1199  | 7    | 31-928  | 7    |         |      |
| 10-1612.1179  | 7    | 31-945  | 7    |         |      |
| 10-2602.3172C | 7    |         |      |         |      |
| 10-2602.3174C | 7    |         |      |         |      |
| 10-2602.3175C | 7    |         |      |         |      |
| 10-2603.3179C | 7    |         |      |         |      |
| 10-4613.3102B | 7    |         |      |         |      |
| 10-4613.3103B | 7    |         |      |         |      |
| 10-4613.3104B | 7    |         |      |         |      |
| 10-4613.3105B | 7    |         |      |         |      |
| 11-906        | 8    |         |      |         |      |
| 19-030.005    | 5    |         |      |         |      |
| 19-031.005    | 5    |         |      |         |      |
| 19-050.005    | 5    |         |      |         |      |
| 19-051.005    | 5    |         |      |         |      |
| 19-139.015    | 5    |         |      |         |      |
| 19-139.035    | 5    |         |      |         |      |
| 19-159.015    | 5    |         |      |         |      |
| 19-159.035    | 5    |         |      |         |      |
| 19-279.015    | 5    |         |      |         |      |
| 19-279.035    | 5    |         |      |         |      |
| 19-289.015    | 5    |         |      |         |      |
| 19-289.035    | 5    |         |      |         |      |
| 19-431.035    | 5    |         |      |         |      |
| 19-432.035    | 5    |         |      |         |      |
| 19-451.035    | 5    |         |      |         |      |
| 19-452.035    | 5    |         |      |         |      |
| 19-471.035    | 5    |         |      |         |      |
| 19-472.035    | 5    |         |      |         |      |
| 19-481.035    | 5    |         |      |         |      |
| 19-482.035    | 5    |         |      |         |      |
| 19-905        | 8    |         |      |         |      |
| 19-906        | 8    |         |      |         |      |
| 19-910        | 8    |         |      |         |      |
| 19-931.0      | 6    |         |      |         |      |
| 19-931.2      | 6    |         |      |         |      |
| 19-931.4      | 6    |         |      |         |      |
| 19-931.5      | 6    |         |      |         |      |
| 19-931.6      | 6    |         |      |         |      |
| 19-931.8      | 6    |         |      |         |      |
| 19-931.9      | 6    |         |      |         |      |
| 19-932.2      | 6    |         |      |         |      |
| 19-932.4      | 6    |         |      |         |      |
| 19-932.5      | 6    |         |      |         |      |
| 19-932.6      | 6    |         |      |         |      |
| 19-932.7      | 6    |         |      |         |      |
| 19-940        | 6    |         |      |         |      |
| 19-941        | 6    |         |      |         |      |
| 19-948.0      | 6    |         |      |         |      |
| 19-949.0      | 6    |         |      |         |      |
| 19-951.0      | 6    |         |      |         |      |
| 19-951.2      | 6    |         |      |         |      |
| 19-951.4      | 6    |         |      |         |      |
| 19-951.5      | 6    |         |      |         |      |
| 19-951.6      | 6    |         |      |         |      |
| 19-951.8      | 6    |         |      |         |      |
| 19-951.9      | 6    |         |      |         |      |
| 19-952.2      | 6    |         |      |         |      |
| 19-952.4      | 6    |         |      |         |      |
| 19-952.5      | 6    |         |      |         |      |
| 19-952.6      | 6    |         |      |         |      |
| 19-952.7      | 6    |         |      |         |      |

|                |   |
|----------------|---|
|                | <b>EAO AG</b>                                 |
|                | Tannwaldstrasse 88<br>4601 Olten, Switzerland |
| <b>E-mail</b>  | info@eao.com                                  |
| <b>Website</b> | www.eao.com                                   |
|                | <b>Austria</b>                                |
| Phone          | +49 201 85 87 0                               |
| Fax            | +49 201 85 87 210                             |
| E-mail         | sales.ede@eao.com                             |
|                | <b>Belgium</b>                                |
| Phone          | +32 3 777 82 36                               |
| Fax            | +32 3 777 84 19                               |
| E-mail         | sales.ebl@eao.com                             |
|                | <b>China</b>                                  |
| Phone          | +852 27 86 91 41                              |
| Fax            | +852 27 86 95 61                              |
| E-mail         | sales.ehk@eao.com                             |
|                | <b>France</b>                                 |
| Phone          | +33 1 64 43 37 37                             |
| Fax            | +33 1 64 43 37 49                             |
| E-mail         | sales.esa@eao.com                             |
|                | <b>Germany</b>                                |
| Phone          | +49 201 85 87 0                               |
| Fax            | +49 201 85 87 210                             |
| E-mail         | sales.ede@eao.com                             |
|                | <b>Italy</b>                                  |
| Phone          | +39 035 481 0189                              |
| Fax            | +39 035 481 3786                              |
| E-mail         | sales.eit@eao.com                             |
|                | <b>Japan</b>                                  |
| Phone          | +81 3 5444 5411                               |
| Fax            | +81 3 5444 0345                               |
| E-mail         | sales.esj@eao.com                             |
|                | <b>Netherlands</b>                            |
| Phone          | +31 78 653 17 00                              |
| Fax            | +31 78 653 17 99                              |
| E-mail         | sales.enl@eao.com                             |
|                | <b>Sweden</b>                                 |
| Phone          | +46 8 683 86 60                               |
| Fax            | +46 8 724 29 12                               |
| E-mail         | sales.esw@eao.com                             |
|                | <b>Switzerland</b>                            |
| Phone          | +41 62 388 95 00                              |
| Fax            | +41 62 388 95 55                              |
| E-mail         | sales.ech@eao.com                             |
|                | <b>United Kingdom</b>                         |
| Phone          | +44 1444 236 000                              |
| Fax            | +44 1444 236 641                              |
| E-mail         | sales.euk@eao.com                             |
|                | <b>USA</b>                                    |
| Phone          | +1 203 877 4577                               |
| Fax            | +1 203 877 3694                               |
| E-mail         | sales.eus@eao.com                             |
|                | <b>Other Countries</b>                        |
| Phone          | +41 62 286 92 10                              |
| Fax            | +41 62 296 21 62                              |
| E-mail         | info@eao.com                                  |



Компания «ЭлектроПласт» предлагает заключение долгосрочных отношений при поставках импортных электронных компонентов на взаимовыгодных условиях!

Наши преимущества:

- Оперативные поставки широкого спектра электронных компонентов отечественного и импортного производства напрямую от производителей и с крупнейших мировых складов;
- Поставка более 17-ти миллионов наименований электронных компонентов;
- Поставка сложных, дефицитных, либо снятых с производства позиций;
- Оперативные сроки поставки под заказ (от 5 рабочих дней);
- Экспресс доставка в любую точку России;
- Техническая поддержка проекта, помощь в подборе аналогов, поставка прототипов;
- Система менеджмента качества сертифицирована по Международному стандарту ISO 9001;
- Лицензия ФСБ на осуществление работ с использованием сведений, составляющих государственную тайну;
- Поставка специализированных компонентов (Xilinx, Altera, Analog Devices, Intersil, Interpoint, Microsemi, Aeroflex, Peregrine, Syfer, Eurofarad, Texas Instrument, Miteq, Cobham, E2V, MA-COM, Hittite, Mini-Circuits, General Dynamics и др.);

Помимо этого, одним из направлений компании «ЭлектроПласт» является направление «Источники питания». Мы предлагаем Вам помощь Конструкторского отдела:

- Подбор оптимального решения, техническое обоснование при выборе компонента;
- Подбор аналогов;
- Консультации по применению компонента;
- Поставка образцов и прототипов;
- Техническая поддержка проекта;
- Защита от снятия компонента с производства.



#### Как с нами связаться

**Телефон:** 8 (812) 309 58 32 (многоканальный)

**Факс:** 8 (812) 320-02-42

**Электронная почта:** [org@eplast1.ru](mailto:org@eplast1.ru)

**Адрес:** 198099, г. Санкт-Петербург, ул. Калинина, дом 2, корпус 4, литера А.