

## Trench gate field-stop 650 V, 40 A high speed HB series IGBT

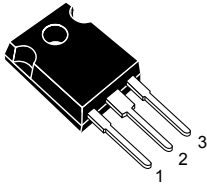

TO-247

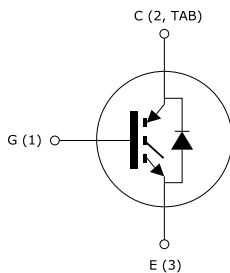

## Product status link

[STGW40H65DFB](#)

## Product summary

Order code	STGW40H65DFB
Marking	GW40H65DFB
Package	TO-247
Packing	Tube

## Features

- Maximum junction temperature:  $T_J = 175\text{ °C}$
- High speed switching series
- Minimized tail current
- Low saturation voltage:  $V_{CE(sat)} = 1.6\text{ V (typ.) @ } I_C = 40\text{ A}$
- Tight parameter distribution
- Safe paralleling
- Positive  $V_{CE(sat)}$  temperature coefficient
- Low thermal resistance
- Very fast soft recovery antiparallel diode

## Applications

- Photovoltaic inverters
- High frequency converters

## Description

This device is an IGBT developed using an advanced proprietary trench gate field-stop structure. The device is part of the new HB series of IGBTs, which represents an optimum compromise between conduction and switching loss to maximize the efficiency of any frequency converter. Furthermore, the slightly positive  $V_{CE(sat)}$  temperature coefficient and very tight parameter distribution result in safer paralleling operation.

# 1 Electrical ratings

**Table 1. Absolute maximum ratings**

Symbol	Parameter	Value	Unit
$V_{CES}$	Collector-emitter voltage ( $V_{GE} = 0$ V)	650	V
$I_C$	Continuous collector current at $T_C = 25$ °C	80	A
	Continuous collector current at $T_C = 100$ °C	40	
$I_{CP}^{(1)}$	Pulsed collector current	160	A
$V_{GE}$	Gate-emitter voltage	$\pm 20$	V
	Transient gate-emitter voltage	$\pm 30$	
$I_F$	Continuous forward current at $T_C = 25$ °C	80	A
	Continuous forward current at $T_C = 100$ °C	40	
$I_{FP}^{(1)}$	Pulsed forward current	160	A
$P_{TOT}$	Total power dissipation at $T_C = 25$ °C	283	W
$T_{STG}$	Storage temperature range	- 55 to 150	°C
$T_J$	Operating junction temperature range	- 55 to 175	

1. Pulse width limited by maximum junction temperature.

**Table 2. Thermal data**

Symbol	Parameter	Value	Unit
$R_{thJC}$	Thermal resistance junction-case IGBT	0.53	°C/W
$R_{thJC}$	Thermal resistance junction-case diode	1.14	
$R_{thJA}$	Thermal resistance junction-ambient	50	

## 2 Electrical characteristics

$T_C = 25\text{ °C}$  unless otherwise specified

**Table 3. Static characteristics**

Symbol	Parameter	Test conditions	Min.	Typ.	Max.	Unit
$V_{(BR)CES}$	Collector-emitter breakdown voltage	$V_{GE} = 0\text{ V}, I_C = 2\text{ mA}$	650			V
$V_{CE(sat)}$	Collector-emitter saturation voltage	$V_{GE} = 15\text{ V}, I_C = 40\text{ A}$		1.6	2	V
		$V_{GE} = 15\text{ V}, I_C = 40\text{ A}, T_J = 125\text{ °C}$		1.7		
		$V_{GE} = 15\text{ V}, I_C = 40\text{ A}, T_J = 175\text{ °C}$		1.8		
$V_F$	Forward on-voltage	$I_F = 40\text{ A}$		1.7	2.45	V
		$I_F = 40\text{ A}, T_J = 125\text{ °C}$		1.4		
		$I_F = 40\text{ A}, T_J = 175\text{ °C}$		1.3		
$V_{GE(th)}$	Gate threshold voltage	$V_{CE} = V_{GE}, I_C = 1\text{ mA}$	5	6	7	V
$I_{CES}$	Collector cut-off current	$V_{GE} = 0\text{ V}, V_{CE} = 650\text{ V}$			25	$\mu\text{A}$
$I_{GES}$	Gate-emitter leakage current	$V_{CE} = 0\text{ V}, V_{GE} = \pm 20\text{ V}$			$\pm 250$	nA

**Table 4. Dynamic characteristics**

Symbol	Parameter	Test conditions	Min.	Typ.	Max.	Unit
$C_{ies}$	Input capacitance	$V_{CE} = 25\text{ V}, f = 1\text{ MHz}, V_{GE} = 0\text{ V}$	-	5412	-	pF
$C_{oes}$	Output capacitance		-	198	-	
$C_{res}$	Reverse transfer capacitance		-	107	-	
$Q_g$	Total gate charge	$V_{CC} = 520\text{ V}, I_C = 40\text{ A}, V_{GE} = 0$ to 15 V (see <a href="#">Figure 28. Gate charge test circuit</a> )	-	210	-	nC
$Q_{ge}$	Gate-emitter charge		-	39	-	
$Q_{gc}$	Gate-collector charge		-	82	-	

**Table 5. IGBT switching characteristics (inductive load)**

Symbol	Parameter	Test conditions	Min.	Typ.	Max.	Unit
$t_{d(on)}$	Turn-on delay time	$V_{CE} = 400\text{ V}$ , $I_C = 40\text{ A}$ , $V_{GE} = 15\text{ V}$ , $R_G = 5\ \Omega$ (see Figure 27. Test circuit for inductive load switching)		40	-	ns
$t_r$	Current rise time			13	-	
$(di/dt)_{on}$	Turn-on current slope			2413	-	A/ $\mu$ s
$t_{d(off)}$	Turn-off-delay time			142	-	ns
$t_f$	Current fall time			27	-	
$E_{on}^{(1)}$	Turn-on switching energy			498	-	$\mu$ J
$E_{off}^{(2)}$	Turn-off switching energy			363	-	
$E_{ts}$	Total switching energy		861	-		
$t_{d(on)}$	Turn-on delay time	$V_{CE} = 400\text{ V}$ , $I_C = 40\text{ A}$ , $V_{GE} = 15\text{ V}$ , $R_G = 5\ \Omega$ $T_J = 175\text{ }^\circ\text{C}$ (see Figure 27. Test circuit for inductive load switching)		38	-	ns
$t_r$	Current rise time			14	-	
$(di/dt)_{on}$	Turn-on current slope			2186	-	A/ $\mu$ s
$t_{d(off)}$	Turn-off-delay time			141	-	ns
$t_f$	Current fall time			61	-	
$E_{on}^{(1)}$	Turn-on switching energy			1417	-	$\mu$ J
$E_{off}^{(2)}$	Turn-off switching energy			764	-	
$E_{ts}$	Total switching energy		2181	-		

1. Including the reverse recovery of the diode.
2. Including the tail of the collector current.

**Table 6. Diode switching characteristics (inductive load)**

Symbol	Parameter	Test conditions	Min.	Typ.	Max.	Unit
$t_{rr}$	Reverse recovery time	$I_F = 40\text{ A}$ , $V_R = 400\text{ V}$ , $V_{GE} = 15\text{ V}$ $di/dt = 100\text{ A}/\mu\text{s}$ (see Figure 27. Test circuit for inductive load switching)	-	62	-	ns
$Q_{rr}$	Reverse recovery charge		-	99	-	nC
$I_{rrm}$	Reverse recovery current		-	3.3	-	A
$dI_{rr}/dt$	Peak rate of fall of reverse recovery current during $t_b$		-	187	-	A/ $\mu$ s
$E_{rr}$	Reverse recovery energy		-	68	-	$\mu$ J
$t_{rr}$	Reverse recovery time	$I_F = 40\text{ A}$ , $V_R = 400\text{ V}$ , $V_{GE} = 15\text{ V}$ , $T_J = 175\text{ }^\circ\text{C}$ $di/dt = 100\text{ A}/\mu\text{s}$ (see Figure 27. Test circuit for inductive load switching)	-	310	-	ns
$Q_{rr}$	Reverse recovery charge		-	1550	-	nC
$I_{rrm}$	Reverse recovery current		-	10	-	A
$dI_{rr}/dt$	Peak rate of fall of reverse recovery current during $t_b$		-	70	-	A/ $\mu$ s
$E_{rr}$	Reverse recovery energy		-	674	-	$\mu$ J

## 2.1 Electrical characteristics (curves)

**Figure 1. Power dissipation vs case temperature**

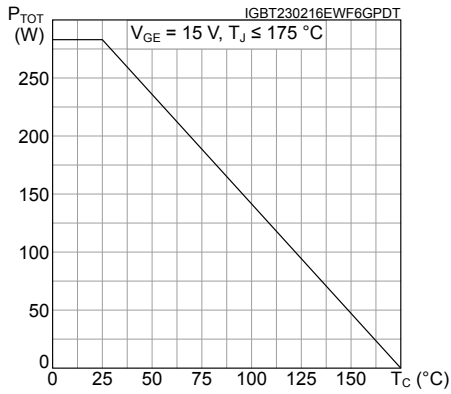

**Figure 2. Collector current vs case temperature**

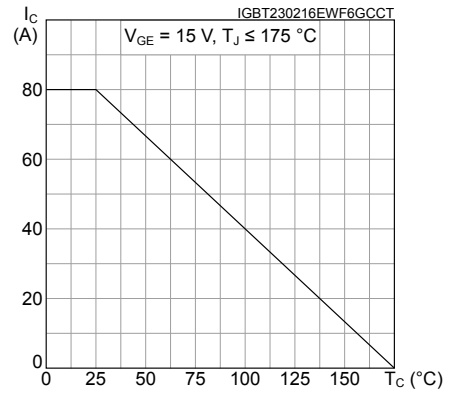

**Figure 3. Output characteristics (T<sub>J</sub> = 25 °C)**

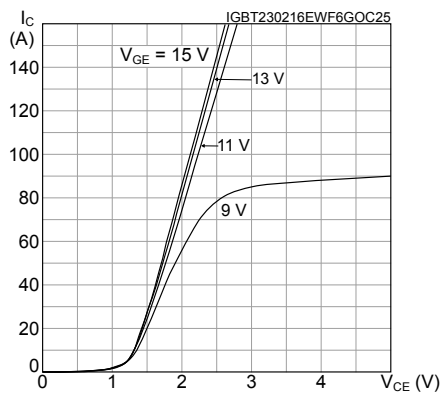

**Figure 4. Output characteristics (T<sub>J</sub> = 175 °C)**

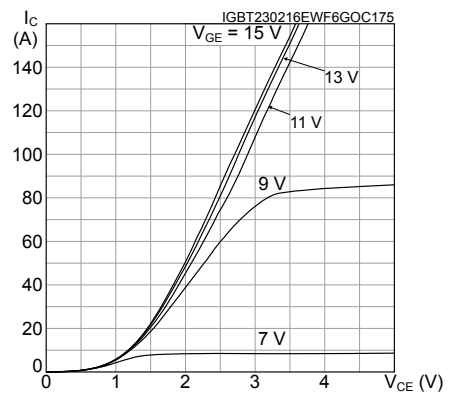

**Figure 5. V<sub>CE(sat)</sub> vs junction temperature**

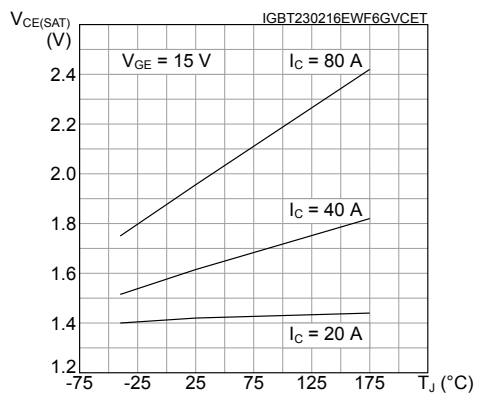

**Figure 6. V<sub>CE(sat)</sub> vs collector current**

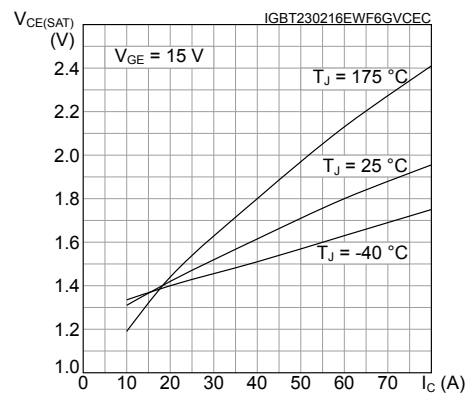

**Figure 7. Collector current vs switching frequency**

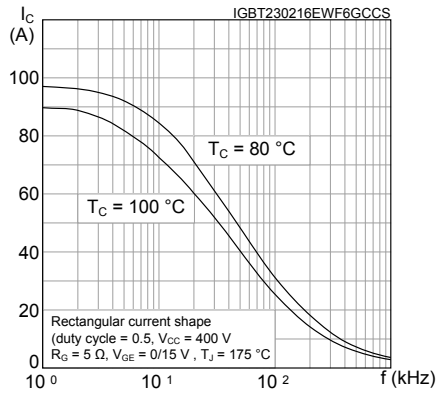

**Figure 8. Forward bias safe operating area**

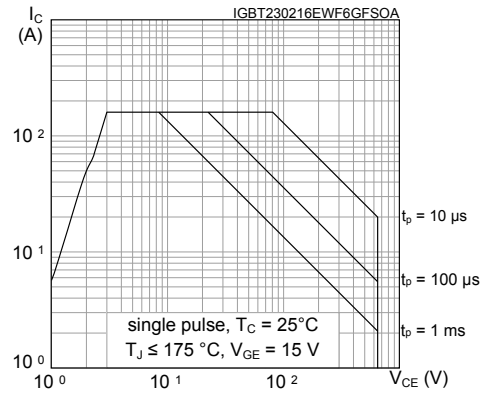

**Figure 9. Transfer characteristics**

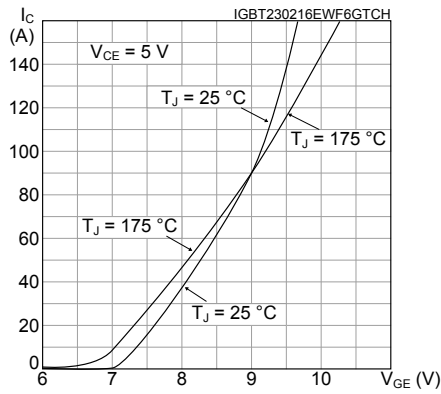

**Figure 10. Diode Vf vs forward current**

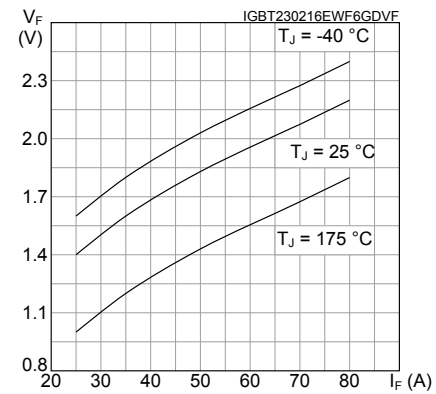

**Figure 11. Normalized Vge(th) vs junction temperature**

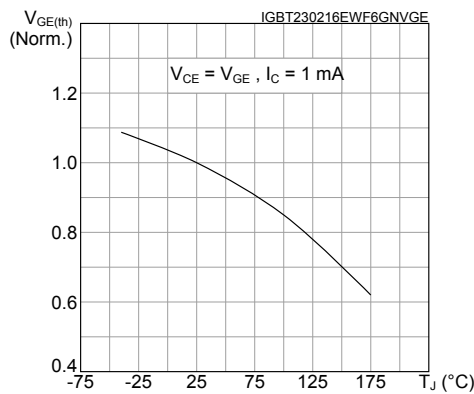

**Figure 12. Normalized V(BR)CES vs junction temperature**

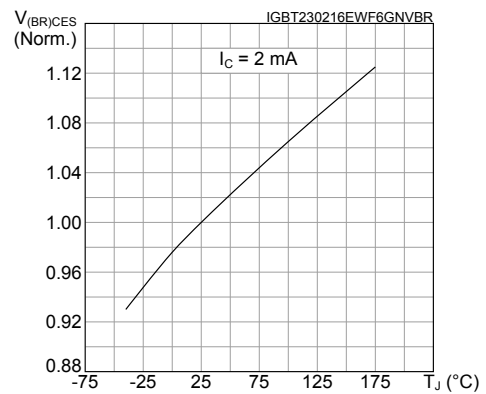

**Figure 13. Capacitance variations**

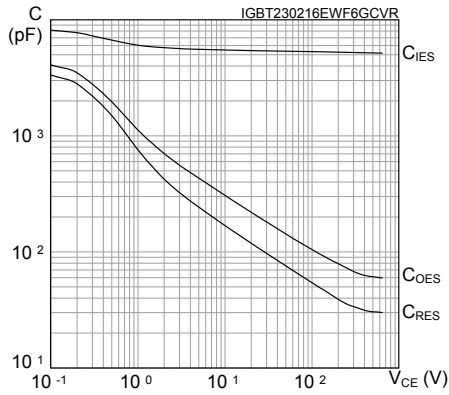

**Figure 14. Gate charge vs gate-emitter voltage**

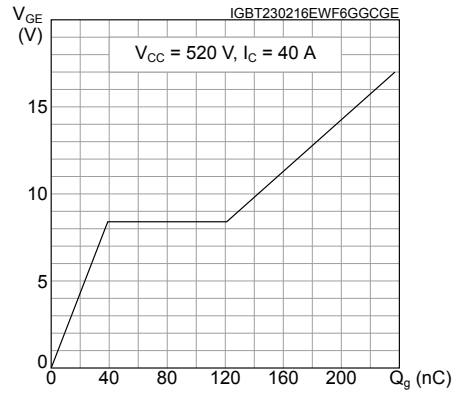

**Figure 15. Switching energy vs collector current**

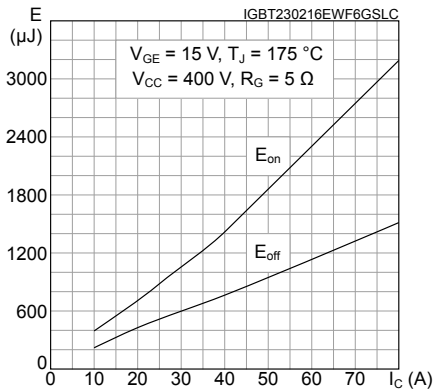

**Figure 16. Switching energy vs gate resistance**

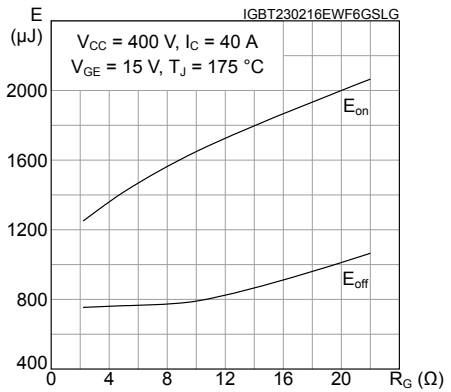

**Figure 17. Switching energy vs temperature**

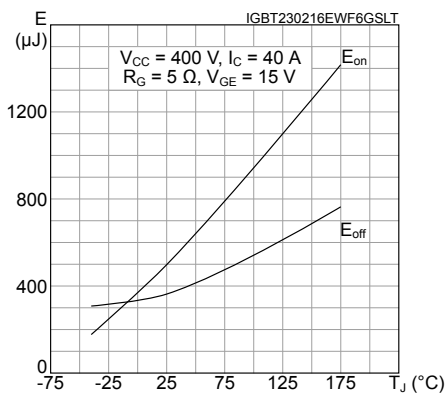

**Figure 18. Switching energy vs collector emitter voltage**

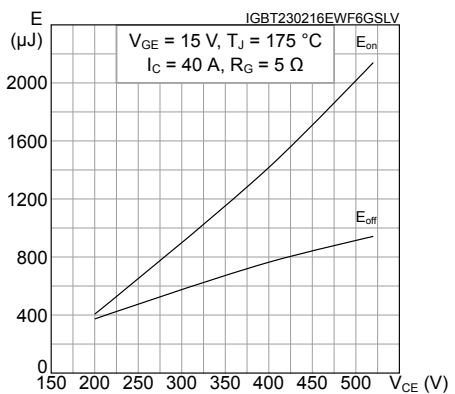

**Figure 19. Switching times vs collector current**

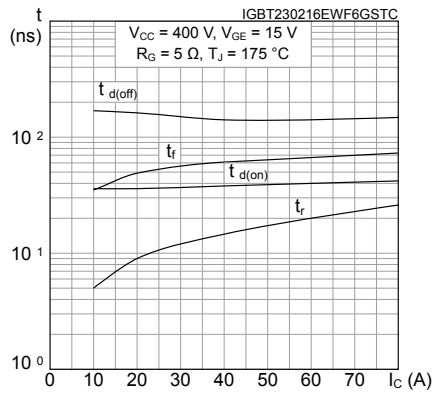

**Figure 20. Switching times vs gate resistance**

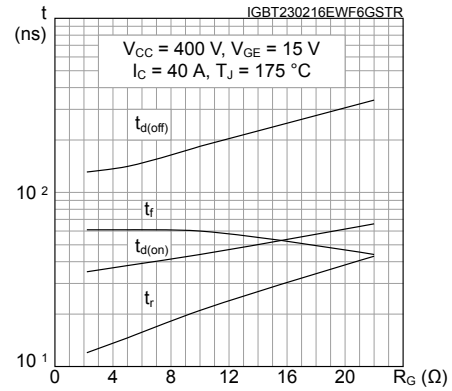

**Figure 21. Reverse recovery current vs diode current slope**

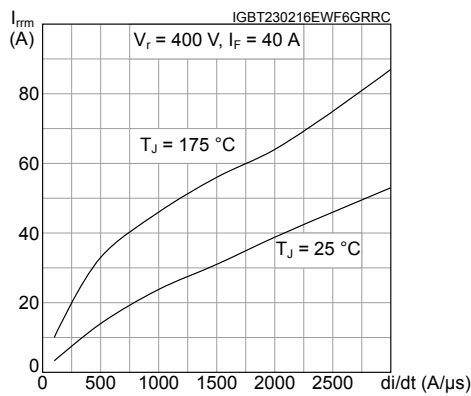

**Figure 22. Reverse recovery time vs diode current slope**

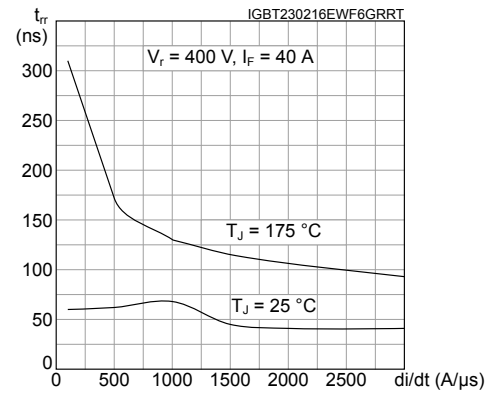

**Figure 23. Reverse recovery charge vs diode current slope**

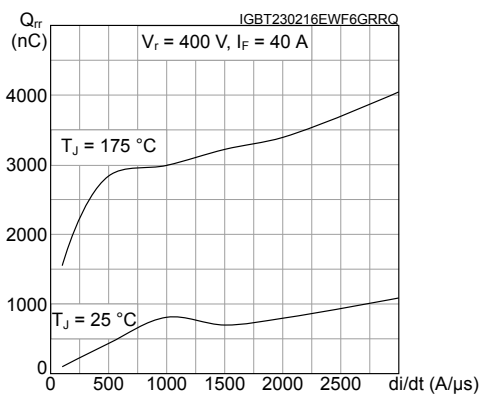

**Figure 24. Reverse recovery energy vs diode current slope**

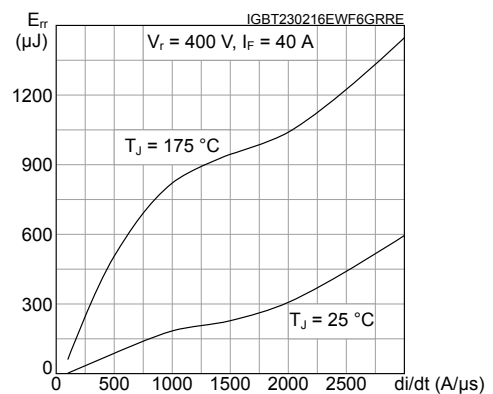



Figure 25. Thermal impedance for IGBT

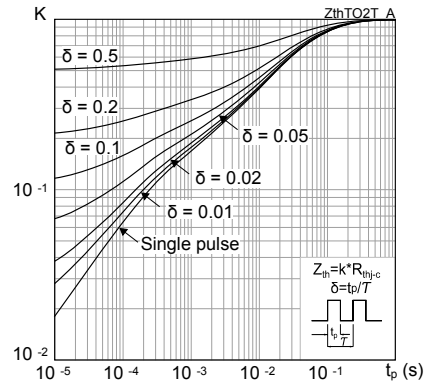
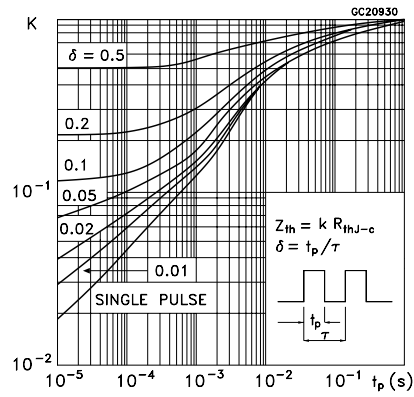

Figure 26. Thermal impedance for diode



### 3 Test circuits

Figure 27. Test circuit for inductive load switching

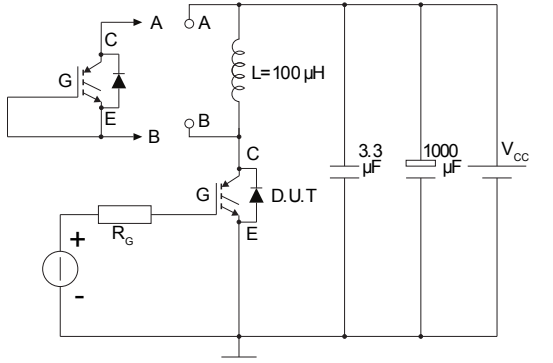

Figure 28. Gate charge test circuit

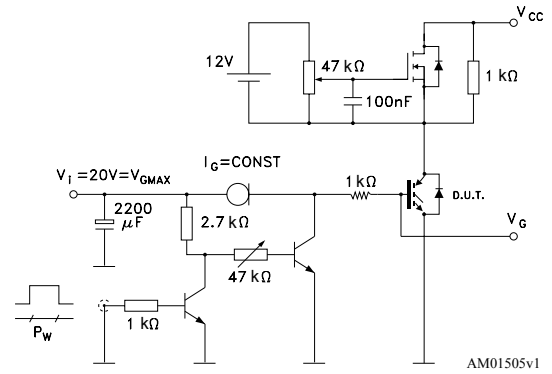

Figure 29. Switching waveform

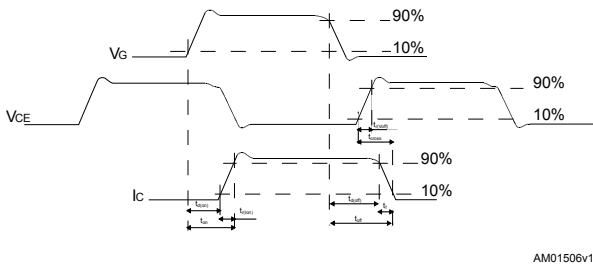
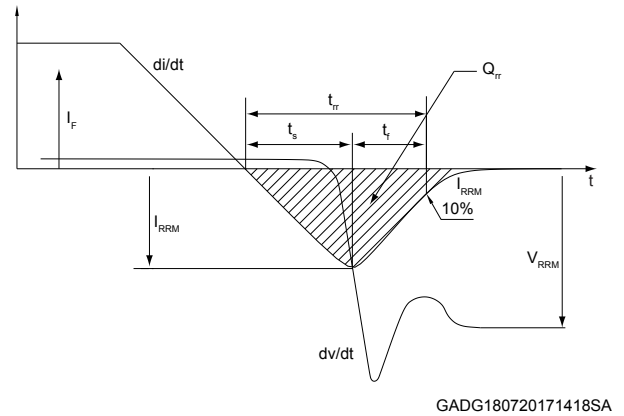

Figure 30. Diode reverse recovery waveform



## 4 Package information

---

In order to meet environmental requirements, ST offers these devices in different grades of **ECOPACK** packages, depending on their level of environmental compliance. ECOPACK specifications, grade definitions and product status are available at: [www.st.com](http://www.st.com). ECOPACK is an ST trademark.

## 4.1 TO-247 package information

Figure 31. TO-247 package outline

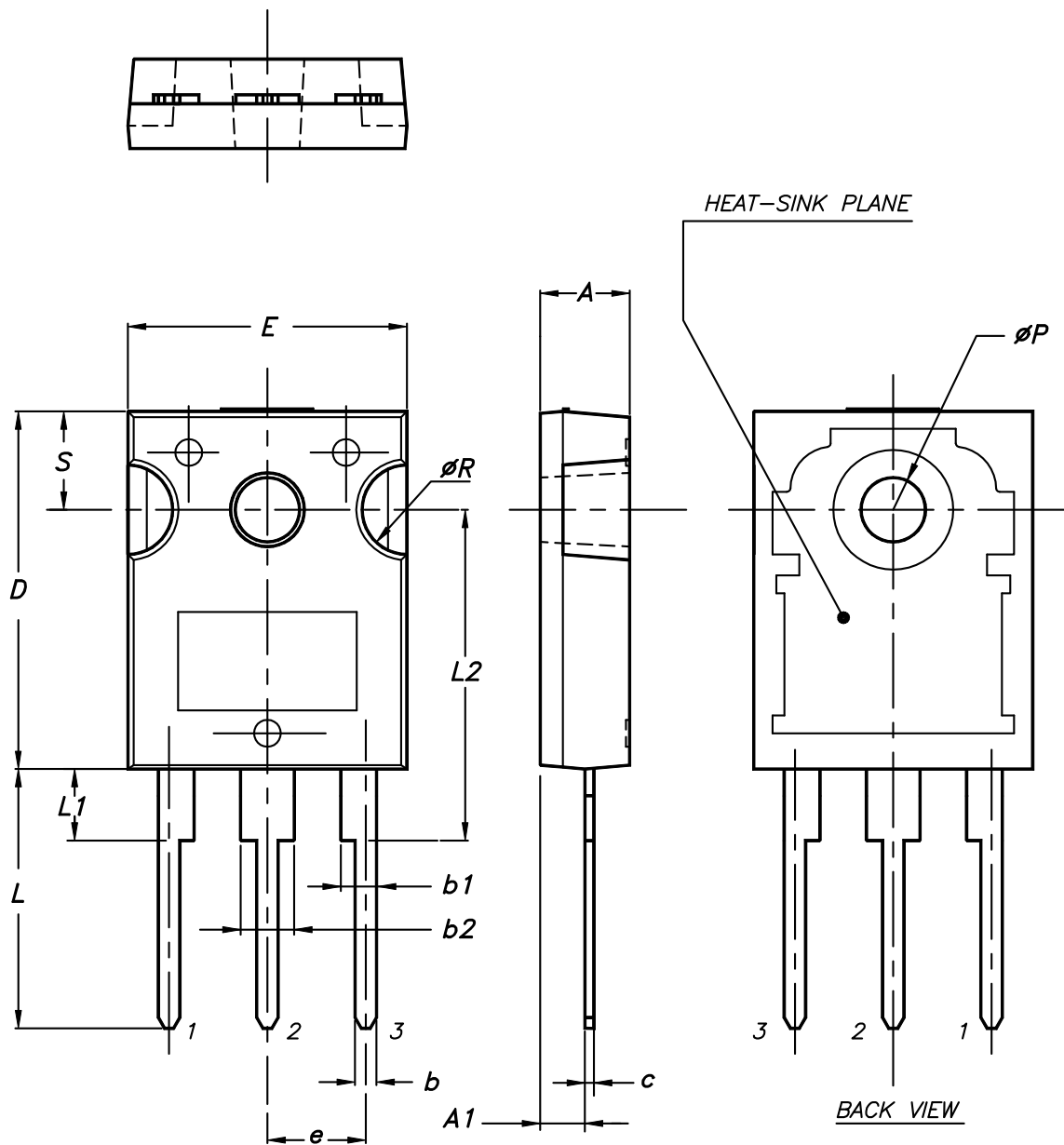

0075325\_9

**Table 7. TO-247 package mechanical data**

Dim.	mm		
	Min.	Typ.	Max.
A	4.85		5.15
A1	2.20		2.60
b	1.0		1.40
b1	2.0		2.40
b2	3.0		3.40
c	0.40		0.80
D	19.85		20.15
E	15.45		15.75
e	5.30	5.45	5.60
L	14.20		14.80
L1	3.70		4.30
L2		18.50	
ØP	3.55		3.65
ØR	4.50		5.50
S	5.30	5.50	5.70

## Revision history

**Table 8. Document revision history**

Date	Revision	Changes
12-Mar-2013	1	Initial release.
09-Sep-2013	2	<ul style="list-style-type: none"> <li>– Modified: VCE(sat) values in cover page</li> <li>– Modified: VCE(sat), VF and VGE(th) typical and max values in Table 4</li> <li>– Modified: entire typical values in Table 5, 6 and 7</li> <li>– Minor text changes</li> <li>– Added: Section 2.1: Electrical characteristics (curves)</li> </ul>
11-Sep-2013	3	– Updated TSTG value in Table 2: Absolute maximum ratings.
23-Sep-2013	4	– Updated units in Table 6: IGBT switching characteristics (inductive load).
31-Oct-2013	5	Updated VCE(sat) in Table 4: Static characteristics.
24-Feb-2014	6	Updated title and description in cover page.
23-Feb-2016	7	<p>Throughout document:</p> <ul style="list-style-type: none"> <li>- added TO-247 long leads package details</li> <li>- text and formatting changes</li> </ul> <p>In "Electrical ratings":</p> <ul style="list-style-type: none"> <li>- updated "Absolute maximum ratings" table.</li> </ul> <p>In "Electrical characteristics":</p> <ul style="list-style-type: none"> <li>- updated "Static characteristics", "IGBT switching characteristics (inductive load)" and "Diode switching characteristics (inductive load)" tables.</li> </ul> <p>Updated "Electrical characteristics (curves)" section.</p> <p>Updated "Package information" section.</p>
07-Jun-2016	8	The part numbers STGWA40H65DFB and STGWT40H65DFB have been moved to a separate datasheet.
19-Jun-2019	9	<p>Removed maturity status indication from cover page. The document status is production data.</p> <p>Updated title in cover page.</p> <p>Updated <a href="#">Table 1. Absolute maximum ratings</a>.</p> <p>Minor text changes.</p>

---

## Contents

<b>1</b>	<b>Electrical ratings</b> .....	<b>2</b>
<b>2</b>	<b>Electrical characteristics</b> .....	<b>3</b>
<b>2.1</b>	<b>Electrical characteristics (curves)</b> .....	<b>4</b>
<b>3</b>	<b>Test circuits</b> .....	<b>10</b>
<b>4</b>	<b>Package information</b> .....	<b>11</b>
<b>4.1</b>	<b>TO-247 package information</b> .....	<b>11</b>
	<b>Revision history</b> .....	<b>14</b>

**IMPORTANT NOTICE – PLEASE READ CAREFULLY**

STMicroelectronics NV and its subsidiaries (“ST”) reserve the right to make changes, corrections, enhancements, modifications, and improvements to ST products and/or to this document at any time without notice. Purchasers should obtain the latest relevant information on ST products before placing orders. ST products are sold pursuant to ST’s terms and conditions of sale in place at the time of order acknowledgement.

Purchasers are solely responsible for the choice, selection, and use of ST products and ST assumes no liability for application assistance or the design of Purchasers’ products.

No license, express or implied, to any intellectual property right is granted by ST herein.

Resale of ST products with provisions different from the information set forth herein shall void any warranty granted by ST for such product.

ST and the ST logo are trademarks of ST. For additional information about ST trademarks, please refer to [www.st.com/trademarks](http://www.st.com/trademarks). All other product or service names are the property of their respective owners.

Information in this document supersedes and replaces information previously supplied in any prior versions of this document.

© 2019 STMicroelectronics – All rights reserved





Компания «ЭлектроПласт» предлагает заключение долгосрочных отношений при поставках импортных электронных компонентов на взаимовыгодных условиях!

Наши преимущества:

- Оперативные поставки широкого спектра электронных компонентов отечественного и импортного производства напрямую от производителей и с крупнейших мировых складов;
- Поставка более 17-ти миллионов наименований электронных компонентов;
- Поставка сложных, дефицитных, либо снятых с производства позиций;
- Оперативные сроки поставки под заказ (от 5 рабочих дней);
- Экспресс доставка в любую точку России;
- Техническая поддержка проекта, помощь в подборе аналогов, поставка прототипов;
- Система менеджмента качества сертифицирована по Международному стандарту ISO 9001;
- Лицензия ФСБ на осуществление работ с использованием сведений, составляющих государственную тайну;
- Поставка специализированных компонентов (Xilinx, Altera, Analog Devices, Intersil, Interpoint, Microsemi, Aeroflex, Peregrine, Syfer, Eurofarad, Texas Instrument, Miteq, Cobham, E2V, MA-COM, Hittite, Mini-Circuits, General Dynamics и др.);

Помимо этого, одним из направлений компании «ЭлектроПласт» является направление «Источники питания». Мы предлагаем Вам помощь Конструкторского отдела:

- Подбор оптимального решения, техническое обоснование при выборе компонента;
- Подбор аналогов;
- Консультации по применению компонента;
- Поставка образцов и прототипов;
- Техническая поддержка проекта;
- Защита от снятия компонента с производства.



#### Как с нами связаться

**Телефон:** 8 (812) 309 58 32 (многоканальный)

**Факс:** 8 (812) 320-02-42

**Электронная почта:** [org@eplast1.ru](mailto:org@eplast1.ru)

**Адрес:** 198099, г. Санкт-Петербург, ул. Калинина, дом 2, корпус 4, литера А.