

# D4 - SERIES

## SPECIFICATIONS AND ORDERING INFORMATION

1.437" DIAMETER 1.5 AMPS @ 28 VDC

The D4 Series switch is the most economical and versatile switch in our open frame rotary line. This series offers the quality feel of a ball and spring index mechanism and is available with up to 12 positions and 30° or 60° indexing.



### SPECIFICATIONS

#### ELECTRICAL

**Current and Voltage Rating:** Make and break resistive load  
1.5 amps @ 28 VDC; 0.5 amp @ 115 VAC.  
**Current Carrying Capacity:** 9 amps.  
**Dielectric Strength:** 1,500 VAC between current carrying parts and ground.  
**Contact Resistance:** Average initial 3.5 milliohms.  
**Insulation Resistance:** Glass epoxy in excess of 750,000 megohms.  
Ceramic in excess of 1,000,000 megohms.  
Diallyl in excess of 900,000 megohms.  
**Hardware:** Mounting nut and lockwasher are shipped assembled.

#### MECHANICAL

**Materials and Finishes:** All parts utilize non-corrosive materials as standard.  
**Clips and Rotors:** Brass with silver plate as standard.  
**Insulation:** Glass epoxy, ceramic, or diallyl phthalate.  
**Index:** Single-ball, hill and valley.  
**Index Life:** 25,000 cycles minimum.  
**Index Torque:** Switches have lowest practical torque consistent with crisp detenting and smooth, reliable operation.  
**Index Angles:** Positive 30° standard, 60° available.  
**Index Stops:** Adjustable standard, fixed or continuous.  
**Stop Strength:** 10 in. lbs. minimum.

### STANDARD PART NUMBER

#### GLASS EPOXY INSULATION

SWITCHES - SOLDER LUG TERMINALS - 30° INDEX - ADJUSTABLE STOPS

FIG. *	NON-SHORTING	SHORTING	NO. OF SECTIONS	POLES/SECTION	ACTIVE POSITIONS
01	D4G0111S	D4G0111N	1	1	02-11
02	D4G0211S	D4G0211N	1	2	02-11
02	D4G0205S	D4G0205N	1	2	02-05
03	D4G0311S	D4G0311N	1	3	02-11
03	D4G0303S	D4G0303N	1	3	02-03
04	D4G0411S	D4G0411N	1	4	02-11
04	D4G0405S	D4G0405N	2	2	02-05
05	D4G0511S	D4G0511N	1	5	02-11
06	D4G0611S	D4G0611N	1	6	02-11
06	D4G0605S	D4G0605N	3	2	02-05
06	D4G0603S	D4G0603N	2	3	02-03
09	D4G0903S	D4G0903N	3	3	02-03

#### CERAMIC INSULATION

SWITCHES - SOLDER LUG TERMINALS - 30° INDEX - ADJUSTABLE STOPS

FIG. *	NON-SHORTING	SHORTING	NO. OF SECTIONS	POLES/SECTION	ACTIVE POSITIONS
01	D4C0112S	D4C0112N	1	1	02-12
02	D4C0212S	D4C0212N	1	2	02-12
02	D4C0206S	D4C0206N	1	2	02-06
03	D4C0312S	D4C0312N	1	3	02-12
03	D4C0305S	D4C0305N	1	3	02-05
04	D4C0412S	D4C0412N	1	4	02-12
04	D4C0406S	D4C0406N	2	2	02-06
05	D4C0512S	D4C0512N	1	5	02-12
05	D4C0503S	D4C0503N	1	5	02-03
06	D4C0612S	D4C0612N	1	6	02-12
06	D4C0606S	D4C0606N	3	2	02-06
06	D4C0605S	D4C0605N	2	3	02-05

\* FIGURES ARE SHOWN ON PAGES 55 AND 56.

### DIMENSIONS

#### STANDARD CONSTRUCTION



NON-TURN LUG  
.125W X .035 THK.  
.437 FROM C-LINE  
.090 ENGAGEMENT

#### D4G - STANDARD GLASS EPOXY CONSTRUCTION

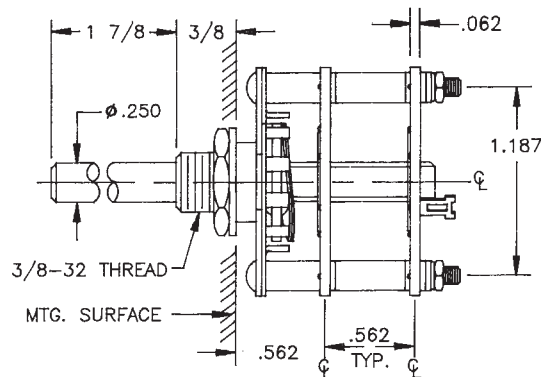

## How to Order Additional Options:

2 DIGIT SERIES	INSULATION TYPE	TOTAL POLES	ACTIVE POSITIONS	CONTACT TYPE	TERMINAL TYPE	INDEX ANGLE	STOP TYPE	SHAFT/ BUSHING	SHAFT FLAT
D4	G - GLASS C - CERAMIC D - DIALLYL	01 - MIN.	12 - MAX @ 30° 06 - MAX @ 60°	N - NON SHORTING S - SHORTING	L - SOLDER LUG R - REAR P.C.	30° 60°	A - ADJ. F - FIXED C - CONT.	SEE CHART "A"	SEE CHART "B"

CUSTOMERS SPECIFIED ORDER NUMBER FOR STANDARD OPTIONS

<b>D</b>	<b>4</b>	<input type="checkbox"/>	<input type="checkbox"/>	<input type="checkbox"/>	<input type="checkbox"/>	<input type="checkbox"/>	<input type="checkbox"/>	<input type="checkbox"/>	<input type="checkbox"/>
		(SPECIFY)	(SPECIFY)	(SPECIFY)	(SPECIFY)	(SPECIFY)	(SPECIFY)	(SPECIFY)	(SPECIFY)

### ADJUSTABLE STOP MECHANISM



REMOVE STOP LUGS TO ACHIEVE MORE POSITIONS.

### SHAFT, BUSHING, AND FLAT OPTIONS

P/N OPT.	SHAFT LGTH. "A"	BUSH. LGTH. "B"
01	3/8	1/4
02	3/8	3/8
03	1/2	1/4
04	1/2	3/8
05	9/16	1/4
06	9/16	3/8
07	3/4	1/4
08	3/4	3/8
09	1	1/4
10	1	3/8
11	1 1/2	1/4
12	1 1/2	3/8
13	1 7/8	1/4
14	1 7/8	3/8

P/N OPT.	FLAT ANGLE
B	ROUND
U	15°
W	165°
Y	195°
Z	345°

SHAFT AS VIEWED WITH NON-TURN LUG AT 9 O'CLOCK AND SHAFT IN EXTREME CCW POSITION AND STRUT BOLTS ORIENTED VERTICALLY.

### INSULATION AND PRINTED CIRCUIT BOARD TERMINAL OPTIONS

D4C - CERAMIC CONSTRUCTION

D4D - DIALLYL PHTHALATE CONSTRUCTION

DIALLYL PHTHALATE P.C. BOARD MOUNTING PATTERN



CUSTOM SWITCHES ARE AVAILABLE. CONTACT THE FACTORY WITH YOUR COMPLETE SPECIFICATIONS.



Компания «ЭлектроПласт» предлагает заключение долгосрочных отношений при поставках импортных электронных компонентов на взаимовыгодных условиях!

Наши преимущества:

- Оперативные поставки широкого спектра электронных компонентов отечественного и импортного производства напрямую от производителей и с крупнейших мировых складов;
- Поставка более 17-ти миллионов наименований электронных компонентов;
- Поставка сложных, дефицитных, либо снятых с производства позиций;
- Оперативные сроки поставки под заказ (от 5 рабочих дней);
- Экспресс доставка в любую точку России;
- Техническая поддержка проекта, помощь в подборе аналогов, поставка прототипов;
- Система менеджмента качества сертифицирована по Международному стандарту ISO 9001;
- Лицензия ФСБ на осуществление работ с использованием сведений, составляющих государственную тайну;
- Поставка специализированных компонентов (Xilinx, Altera, Analog Devices, Intersil, Interpoint, Microsemi, Aeroflex, Peregrine, Syfer, Eurofarad, Texas Instrument, Miteq, Cobham, E2V, MA-COM, Hittite, Mini-Circuits, General Dynamics и др.);

Помимо этого, одним из направлений компании «ЭлектроПласт» является направление «Источники питания». Мы предлагаем Вам помощь Конструкторского отдела:

- Подбор оптимального решения, техническое обоснование при выборе компонента;
- Подбор аналогов;
- Консультации по применению компонента;
- Поставка образцов и прототипов;
- Техническая поддержка проекта;
- Защита от снятия компонента с производства.



#### Как с нами связаться

**Телефон:** 8 (812) 309 58 32 (многоканальный)

**Факс:** 8 (812) 320-02-42

**Электронная почта:** [org@eplast1.ru](mailto:org@eplast1.ru)

**Адрес:** 198099, г. Санкт-Петербург, ул. Калинина, дом 2, корпус 4, литера А.