

SUBMINIATURE MICROSWITCHES - DOUBLE BREAK

83132 / 83133 / 83134

- › Double-break flexible leaf snap-action mechanism
- › Side, rear or on front face terminals
- › Momentary or maintained action (option)
- › Very long life
- › Ratings from 1 mA 4V_{DC} to 6 A 250 V_{AC}
- › Operating temperature -40 °C up to +150 °C
- › Wide choice of actuators on 2 symmetric fixing positions



Main specifications

Function	Connections	Side outputs 83132		Rear outputs 83133		Front face outputs 83134	
		Standard	Dual-current (DORE)	Standard	Dual-current (DORE)	Standard	Dual-current (DORE)
I (changeover)	W2	83132030	83132053	83133035	83133073	-	-
I (changeover)	X1	-	-	83133045	83133052	83134001	83134003
R (normally closed)	W2	83132032	●	83133042	83133210	-	-
R (normally closed)	X1	-	-	●	●	-	-
C (normally open)	W2	83132040	●	83133050	●	-	-
C (normally open)	X1	-	-	●	●	-	-
Electrical characteristics							
Rating nominal / 250 V AC (A)		6	5*	6	5*	6	5*
Rating thermal / 250 V AC (A)		11		11		11	
Mechanical characteristics							
Maximum operating force (N)		1.6		1.6		1.6	
Min. Release force (N)		0.4		0.4		0.4	
Max. Allowable overtravel force (N)		10		10		10	
Rest position max. (mm)		8.45		8.45		8.10	
Operating position (mm)		7.7±0.2		7.7±0.2		7.35±0.25	
Differential travel (mm)		0.35±0.1		0.35±0.1		0.35±0.1	
Min. overtravel (mm)		0.27		0.27		0.27	
Ambient operating temperature (°C)		-40 → +125		-40 → +125		-40 → +125	
Mechanical life (operations)		10 ⁷		10 ⁷		10 ⁷	
Contact gap (mm)		0.3 x 2		0.3 x 2		0.3 x 2	
Weight (g)		1.8		1.8		1.8	

Additional specifications

- Case, Button: PA66 GF (UL 94-V0 / GWFI 960 °C / GWIT 775 °C)
 - Moving blade: beryllium copper
 - Contacts: silver, gold-plated silver (dual-current)
 - Terminals: copper nickel
 - Levers: stainless steel, polyamide roller
 - Degree of protection: IP40 (mechanism)
 - Proof tracking index: PTI 400
 - Recommended min actuating speed: 0.01 mm/s
- Note: fixing holes are fitted with metal inserts

Product adaptations



- › Maintained action variants (bistable reset switch), with or without lever
- › 2 or 3-pole assembly with single actuator. Optional mounting on metal plate (8331)
- › Special levers: special shapes and lengths
- › Plunger with ball (Ø 5 mm) for lateral approach from any direction
- › High operating temperature: max +150 °C
- › Applications in irradiated environment
- › Higher operating force: max 2.6 N
- › Larger overtravel: min 0.5 mm (SP4225)
- › Added overtravel and/or adjustable fixing by threaded barrel (see 83528 and 8354 Series)
- › cURus and NF approved versions up to 480 V_{AC}

Principles

Double break snap-action switch
Changeover - SPDT (form Za)



Normally closed - SPST-NC (form Y)

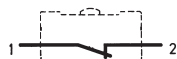

Normally open - SPST-NO (form X)



Both circuits must be used at same polarity

Standard product

Product made to order



Contact us

Curves

Operating curve for types 83132 - 83133 - 83134

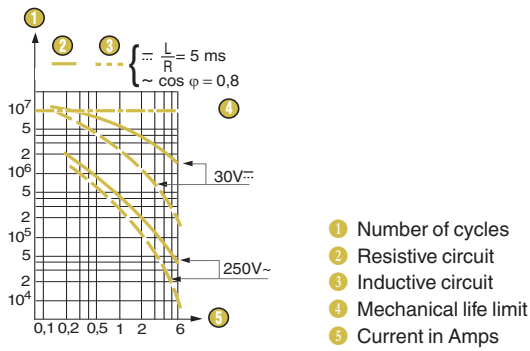

* Dual-current models are designed to operate equally well on low-current (1 mA 4 V minimum recommended) or medium-current (5 A maximum) circuits. However, a given product should only be used to switch one type of circuit during its working life.

Dimensions

Product

83132

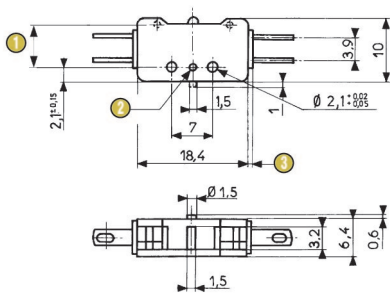

- 1** Total travel position = 7.35 max.
- 2** Ø1.5, depth 0.7
- 3** 2 PTFE plates, thickness 0.8

83133

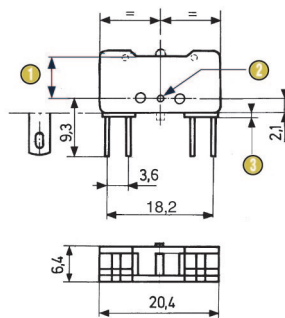

83134

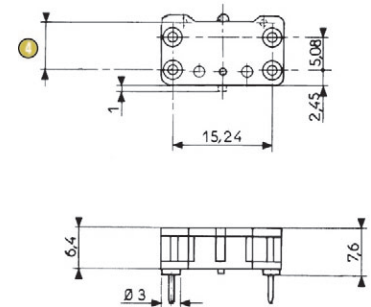

- 4** Total travel position = 7 max.

Connections

W2 solder or quick-connect 2.8 x 0.5 (83132 - 83133)

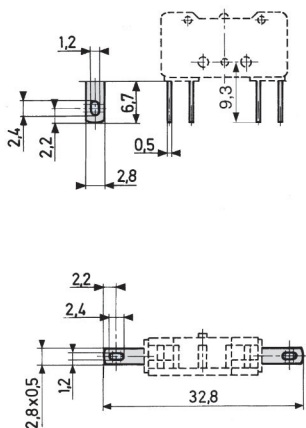

X1 for PCB, straight output (83133)

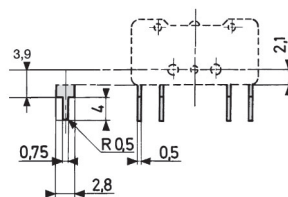

X1 for PCB, straight output (83134)

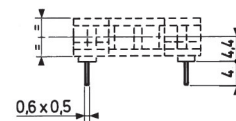

Actuators

54A flat

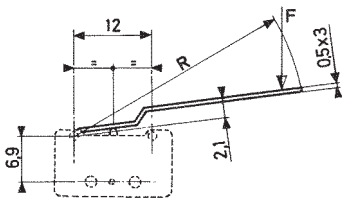

54B folded

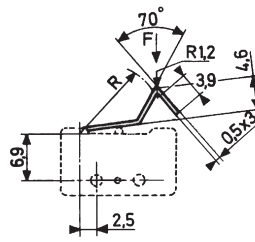

54E roller

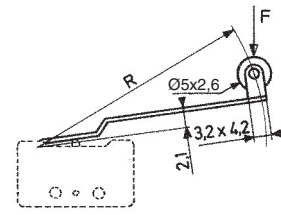

54A2 2-pole

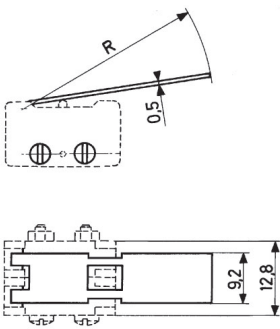

54D adjustable

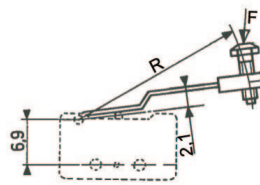

54EL transverse roller

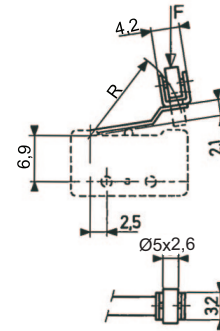

Standard mounting position

For 831320 and 831330

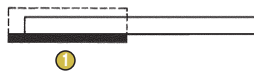



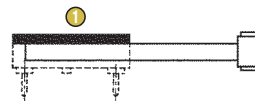

1 Cover







For 831340



1 Cover

Actuators and mounting accessories

Part numbers for standard actuators	70514175	70514194	70514181	70514182	70514183
Actuators	Flat 54A R14.75	Flat 54A R35.75	Roller 54E R7.5	Roller 54E R14.1	Roller 54E R34.4
					
	83132 83133 83134	83132 83133 83134	83132 83133 83134	83132 83133 83134	83132 83133 83134
Operating position mm	9.5 ±0.8 9.2 ±0.8	10 ±1.5 9.7 ±0.15	14.2 ±0.3 13.9 ±0.3	15.5 ±0.8 15.2 ±0.8	16.1 ±1.4 15.8 ±1.4
Operating force max. N	0.8	0.34	1.6	0.8	0.34
Release force min. N	0.16	0.06	0.32	0.17	0.07
Pretravel max. mm	2.15	5.15	1.1	2.05	4.9
Differential travel mm	1 ±0.3	2.1 ±0.65	0.5 ±0.15	0.95 ±0.3	2 ±0.6
Total travel max. mm	2.8	6.8	1.45	2.7	6.6

Part numbers for standard actuators	70514559	70514125	70514188	70514178	70514179	70514280
Actuators	Folded 54B R13.17	2-pole 54A2 R30	Adjustable 54D R27.1	Transverse Roller 54EL R7.5	Transverse Roller 54EL R14.1	Side fixing plate 54Y stainless steel (16 x 8 x 0,4 mm)
						
	83132 83133 83134	83132 83133	83132 83133 83134	83132 83133 83134	83132 83133 83134	Always supplied separately
Operating position mm	12.7 ±0.8 12.4 ±0.8	8.8 ±0.8	12.6-17.6 ±1.2 12.3-17.3 ±1.2	14.2 ±0.3 13.9 ±0.3	15.6 ±0.8 15.3 ±0.8	
Operating force max. N	0.85	0.8	0.43	1.6	0.75	
Release force min. N	0.18	0.16	0.08	0.32	0.15	
Pretravel max. mm	2.05	4.3	3.9	1.1	2.25	
Differential travel mm	0.95 ±0.3	2 ±0.55	1.8 ±0.5	0.5 ±0.15	1 ±0.35	
Total travel max. mm	2.7	5.75	5.2	1.45	3	

Unless mentioned specifically, the levers are mounted in the position illustrated on the dimension diagrams (standard mounting). We recommend that these levers are assembled in our workshops.

83132/133/134 microswitches with referenced actuators

Lever (standard mounting = on left)				54A		54A2	54B	54D	54E			54EL	
Mounting				R14.75	R35.75	R30	R13.17	R27.1	R7.5	R14.1	R34.4	R7.5	R14.1
Part numbers				70514175	70514194	70514125	70514559	70514188	70514181	70514182	70514183	70514178	70514179
STANDARD	83132	IW2	Standard	83132039	83132045	•	83132087	83132076	83132033	83132003	83132005	•	83132054
	83133	IW2	Standard	83133015	83133038	83133301	83133171	83133118	83133004	83133002	83133003	83133058	83133059
		IX1	Standard	83133174	83133062	83133306	83133212	83133120	•	83133119	•	•	•
DUAL-CURRENT	83134	IX1	Standard	83134004	83134016	-	83134002	•	83134015	83134011	83134009	•	•
			On right	83134005	83134012	-	83134007	•	•	83134006	•	•	•
	83132	IW2	Standard	83132090	•	•	•	•	•	•	•	•	•
83133	IX1	Standard	•	•	•	•	•	•	•	83133122	•	•	•
		Standard	•	83133173	•	•	•	•	•	•	•	•	•
83134	IX1	Standard	83134046	•	-	83134028	•	•	•	83134014	•	•	•
		On right	•	•	-	•	•	•	•	•	•	•	•

Installation recommendations

See "Basic technical concepts"

For 83133 and 83134: to ensure protection against electric shock after installation in the application, please consult us when conductive parts are located in the immediate proximity of the side walls of the switch housing.

How to order

Use the 8 digit part numbers when they are defined

Other cases, precise: Type of microswitch - Function - Connection -Contact* - UL approval* - Actuator* - Fixing position* - Adaptation*
* if needed

Example: 83133 I W2 DORE UL 54E R7.5

Examples of special adaptations



Maintained action variant (bistable reset switch) for level regulation. Has lever with hole for push-pull actuation by a rod with 2 stops



Plunger with ball (Ø 5 mm) for lateral approach from any direction

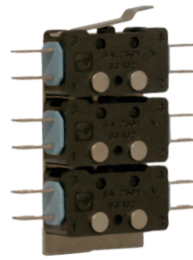

3 pole assembly (3PDT) on metal plate: 833162



«US format»: housing with 1/2" (12.7 mm) mounting hole pitch (831337)



Flexible pre-armed lever: provides both precise operating position and extra-long overtravel (5 mm)



Компания «ЭлектроПласт» предлагает заключение долгосрочных отношений при поставках импортных электронных компонентов на взаимовыгодных условиях!

Наши преимущества:

- Оперативные поставки широкого спектра электронных компонентов отечественного и импортного производства напрямую от производителей и с крупнейших мировых складов;
- Поставка более 17-ти миллионов наименований электронных компонентов;
- Поставка сложных, дефицитных, либо снятых с производства позиций;
- Оперативные сроки поставки под заказ (от 5 рабочих дней);
- Экспресс доставка в любую точку России;
- Техническая поддержка проекта, помощь в подборе аналогов, поставка прототипов;
- Система менеджмента качества сертифицирована по Международному стандарту ISO 9001;
- Лицензия ФСБ на осуществление работ с использованием сведений, составляющих государственную тайну;
- Поставка специализированных компонентов (Xilinx, Altera, Analog Devices, Intersil, Interpoint, Microsemi, Aeroflex, Peregrine, Syfer, Eurofarad, Texas Instrument, Miteq, Cobham, E2V, MA-COM, Hittite, Mini-Circuits, General Dynamics и др.);

Помимо этого, одним из направлений компании «ЭлектроПласт» является направление «Источники питания». Мы предлагаем Вам помощь Конструкторского отдела:

- Подбор оптимального решения, техническое обоснование при выборе компонента;
- Подбор аналогов;
- Консультации по применению компонента;
- Поставка образцов и прототипов;
- Техническая поддержка проекта;
- Защита от снятия компонента с производства.



Как с нами связаться

Телефон: 8 (812) 309 58 32 (многоканальный)

Факс: 8 (812) 320-02-42

Электронная почта: org@eplast1.ru

Адрес: 198099, г. Санкт-Петербург, ул. Калинина, дом 2, корпус 4, литера А.