

The S-8520/8521 Series is a CMOS step-down switching regulator-controller with PWM control (S-8520 Series) and PWM / PFM switching control (S-8521 Series). The S-8520/8521 Series has a reference voltage source, an oscillation circuit, an error amplifier, and other components.

The S-8520 Series provides low-ripple power, high efficiency, and excellent transient characteristics due to a PWM control circuit capable of varying the duty ratio linearly from 0% up to 100%. The S-8520/8521 Series also has a soft-start circuit that prevents overshoot at startup.

The S-8521 Series works with either PWM control or PFM control. It normally operates using PWM control with a duty ratio of 25% to 100%, but under a light load, it automatically switches to PFM control with a duty ratio of 25%. The S-8520/8521 Series ensures high efficiency over a wide range of conditions for devices, from the standby mode to the operation.

By adding external Pch power MOS FET or PNP transistor, coil, capacitor, and externally connected diode, the S-8520/8521 Series can function as a step-down switching regulator, and is ideal for power supply units of portable devices due to small SOT-23-5 and the feature of low current consumption. It is also ideal for AC adapters due to the input voltage up to 16 V.

■ Features

- Low current consumption During operation: 60 μ A max. (A, B types)
 21 μ A max. (C, D types)
 100 μ A max. (E, F types)
 During shutdown: 0.5 μ A max.
- Input voltage: 2.5 V to 16 V (B, D, F types)
 2.5 V to 10 V (A, C, E types)
- Output voltage: Selectable between 1.5 V and 6.0 V in 0.1 V step
- Duty ratio: 0% to 100% PWM control (S-8520 Series)
 25% to 100% PWM / PFM switching control (S-8521 Series)
- External parts are Pch power MOS FET or PNP transistor, coil, diode, and capacitor only
 (When using PNP transistor, add base resistor and capacitor).
- Oscillation frequency: 180 kHz typ. (A, B types)
 60 kHz typ. (C, D types)
 300 kHz typ. (E, F types)
- Soft-start function: 8 ms. typ. (A, B types)
 12 ms. typ. (C, D types)
 4.5 ms. typ. (E, F types)
- With a shutdown function
- With a built-in overload protection circuit Overload detection time: 4 ms. typ. (A type)
 14 ms. typ. (C type)
 2.6 ms. typ. (E type)
- Lead-free, Sn 100%, halogen-free^{*1}

*1. Refer to “■ Product Name Structure” for details.

■ Applications

- On-board power supplies of battery devices for mobile phone, electronic notebooks, PDAs.
- Power supplies for audio equipment, including portable CD players and headphone stereo equipment.
- Fixed voltage power supply for cameras, video and communication devices.
- Power supplies for microcomputers
- Conversion from NiH or four NiCd cells or two lithium-ion cells to 3.3 V / 3 V.
- Conversion of AC adapter input to 5 V / 3 V.

■ Package

- SOT-23-5

■ Block Diagrams

1. S-8520 Series



Remark All the diodes in the figure are parasitic diodes.

Figure 1

2. S-8521 Series



Remark All the diodes in the figure are parasitic diodes.

Figure 2

■ **Product Name Structure**

The control types, product types, and output voltage for the S-8520/8521 Series can be selected at the user's request. Please refer to the "1. **Product name**" for the definition of the product name, "2. **Package**" regarding the package drawings and "3. **Product name list**" for the full product names.

1. Product name



*1. Refer to the tape specifications.
 *2. Refer to "3. **Product name list**".

2. Package

Package Name	Drawing code		
	Package	Tape	Reel
SOT-23-5	MP005-A-P-SD	MP005-A-C-SD	MP005-A-R-SD

3. Product name list

3.1 S-8520 Series

Table 1 (1 / 2)

Output voltage [V]	S-8520AxxMC Series	S-8520BxxMC Series	S-8520CxxMC Series
1.5	-	S-8520B15MC-ARAT2x	-
1.8	-	S-8520B18MC-ARDT2x	-
2.0	S-8520A20MC-AVFT2x	-	-
2.1	S-8520A21MC-AVGT2x	-	-
2.4	-	S-8520B24MC-ARJT2x	-
2.5	S-8520A25MC-AVKT2x	S-8520B25MC-ARKT2x	S-8520C25MC-BRKT2x
2.6	S-8520A26MC-AVLT2x	-	-
2.7	S-8520A27MC-AVMT2x	S-8520B27MC-ARMT2x	S-8520C27MC-BRMT2x
2.8	S-8520A28MC-AVNT2x	S-8520B28MC-ARNT2x	S-8520C28MC-BRNT2x
2.9	S-8520A29MC-AVOT2x	S-8520B29MC-AROT2x	S-8520C29MC-BROT2x
3.0	S-8520A30MC-AVPT2x	S-8520B30MC-ARPT2x	S-8520C30MC-BRPT2x
3.1	S-8520A31MC-AVQT2x	S-8520B31MC-ARQT2x	S-8520C31MC-BRQT2x
3.2	S-8520A32MC-AVRT2x	S-8520B32MC-ARRT2x	S-8520C32MC-BRRT2x
3.3	S-8520A33MC-AVST2x	S-8520B33MC-ARST2x	S-8520C33MC-BRST2x
3.4	S-8520A34MC-AVTT2x	S-8520B34MC-ARTT2x	S-8520C34MC-BRST2x
3.5	S-8520A35MC-AVUT2x	S-8520B35MC-ARUT2x	S-8520C35MC-BRUT2x
3.6	S-8520A36MC-AVVT2x	S-8520B36MC-ARVT2x	S-8520C36MC-BRVT2x
4.0	-	S-8520B40MC-ARZT2x	-
4.3	-	S-8520B43MC-ASCT2x	-
5.0	S-8520A50MC-AWJT2x	S-8520B50MC-ASJT2x	S-8520C50MC-BSJT2x
5.3	-	S-8520B53MC-ASMT2x	-

Table 1 (2 / 2)

Output voltage [V]	S-8520DxxMC Series	S-8520ExxMC Series	S-8520FxxMC Series
1.5	-	S-8520E15MC-BJAT2x	S-8520F15MC-BNAT2x
1.6	-	S-8520E16MC-BJBT2x	-
1.8	-	S-8520E18MC-BJDT2x	S-8520F18MC-BNDT2x
2.0	-	-	S-8520F20MC-BNFT2x
2.5	S-8520D25MC-BVKT2x	S-8520E25MC-BJKT2x	S-8520F25MC-BNKT2x
2.6	-	-	S-8520F26MC-BNLT2x
2.7	S-8520D27MC-BVMT2x	-	S-8520F27MC-BNMT2x
2.8	S-8520D28MC-BVNT2x	S-8520E28MC-BJNT2x	S-8520F28MC-BNNT2x
2.9	S-8520D29MC-BVOT2x	-	-
3.0	S-8520D30MC-BVPT2x	S-8520E30MC-BJPT2x	S-8520F30MC-BNPT2x
3.1	S-8520D31MC-BVQT2x	-	S-8520F31MC-BNQT2x
3.2	S-8520D32MC-BVRT2x	-	-
3.3	S-8520D33MC-BVST2x	S-8520E33MC-BJST2x	S-8520F33MC-BNST2x
3.4	S-8520D34MC-BVTT2x	-	S-8520F34MC-BNNT2x
3.5	S-8520D35MC-BVUT2x	-	S-8520F35MC-BNUT2x
3.6	S-8520D36MC-BVVT2x	-	S-8520F36MC-BNVT2x
4.0	-	-	S-8520F40MC-BNZT2x
4.5	-	-	S-8520F45MC-BOET2x
5.0	S-8520D50MC-BWJT2x	S-8520E50MC-BKJT2x	S-8520F50MC-BOJT2x
5.2	-	S-8520E52MC-BKLT2x	-
5.5	-	-	S-8520F55MC-BOOT2x
6.0	-	-	S-8520F60MC-BOTT2x

Remark 1. Please contact our sales office for products with output voltage other than those specified above.

2. x: G or U

3. Please select products of environmental code = U for Sn 100%, halogen-free products.

3.2 S-8521 Series

Table 2 (1 / 2)

Output voltage [V]	S-8521AxxMC Series	S-8521BxxMC Series	S-8521CxxMC Series
1.5	-	S-8521B15MC-ATAT2x	-
1.6	-	-	S-8521C16MC-BTBT2x
1.8	-	S-8521B18MC-ATDT2x	-
1.9	-	S-8521B19MC-ATET2x	-
2.0	-	S-8521B20MC-ATFT2x	-
2.1	-	S-8521B21MC-ATGT2x	-
2.3	-	S-8521B23MC-ATIT2x	-
2.5	S-8521A25MC-AXKT2x	S-8521B25MC-ATKT2x	S-8521C25MC-BTKT2x
2.6	-	S-8521B26MC-ATLT2x	-
2.7	S-8521A27MC-AXMT2x	S-8521B27MC-ATMT2x	S-8521C27MC-BTMT2x
2.8	S-8521A28MC-AXNT2x	S-8521B28MC-ATNT2x	S-8521C28MC-BTNT2x
2.9	S-8521A29MC-AXOT2x	S-8521B29MC-ATOT2x	S-8521C29MC-BTOT2x
3.0	S-8521A30MC-AXPT2x	S-8521B30MC-ATPT2x	S-8521C30MC-BTPT2x
3.1	S-8521A31MC-AXQT2x	S-8521B31MC-ATQT2x	S-8521C31MC-BTQT2x
3.2	S-8521A32MC-AXRT2x	S-8521B32MC-ATRT2x	S-8521C32MC-BTRT2x
3.3	S-8521A33MC-AXST2x	S-8521B33MC-ATST2x	S-8521C33MC-BTST2x
3.4	S-8521A34MC-AXTT2x	S-8521B34MC-ATTT2x	S-8521C34MC-BTTT2x
3.5	S-8521A35MC-AXUT2x	S-8521B35MC-ATUT2x	S-8521C35MC-BTUT2x
3.6	S-8521A36MC-AXVT2x	S-8521B36MC-ATVT2x	S-8521C36MC-BTVT2x
4.0	-	S-8521B40MC-ATZT2x	-
4.4	-	S-8521B44MC-AUDT2x	-
5.0	S-8521A50MC-AYJT2x	S-8521B50MC-AUJT2x	S-8521C50MC-BUJT2x
5.1	-	S-8521B51MC-AUKT2x	-
5.3	-	S-8521B53MC-AUMT2x	-
6.0	-	S-8521B60MC-AUTT2x	-

Table 2 (2 / 2)

Output voltage [V]	S-8521DxxMC Series	S-8521ExxMC Series	S-8521FxxMC Series
1.5	-	S-8521E15MC-BLAT2x	S-8521F15MC-BPAT2x
1.6	S-8521D16MC-BXBT2x	S-8521E16MC-BLBT2x	-
1.7	-	S-8521E17MC-BLCT2x	-
1.8	S-8521D18MC-BXDT2x	S-8521E18MC-BLDT2x	S-8521F18MC-BPDT2x
1.9	-	S-8521E19MC-BLET2x	S-8521F19MC-BPET2x
2.0	S-8521D20MC-BXFT2x	S-8521E20MC-BLFT2x	-
2.1	S-8521D21MC-BXGT2x	-	-
2.2	S-8521D22MC-BXHT2x	S-8521E22MC-BLHT2x	-
2.5	S-8521D25MC-BXKT2x	S-8521E25MC-BLKT2x	S-8521F25MC-BPKT2x
2.7	S-8521D27MC-BXMT2x	-	-
2.8	S-8521D28MC-BXNT2x	-	-
2.9	S-8521D29MC-BXOT2x	-	-
3.0	S-8521D30MC-BXPT2x	S-8521E30MC-BLPT2x	S-8521F30MC-BPPT2x
3.1	S-8521D31MC-BXQT2x	-	-
3.2	S-8521D32MC-BXRT2x	-	S-8521F32MC-BPRT2x
3.3	S-8521D33MC-BXST2x	S-8521E33MC-BLST2x	S-8521F33MC-BPST2x
3.4	S-8521D34MC-BXTT2x	-	S-8521F34MC-BPTT2x
3.5	S-8521D35MC-BXUT2x	S-8521E35MC-BLUT2x	-
3.6	S-8521D36MC-BXVT2x	-	S-8521F36MC-BPVT2x
4.0	S-8521D40MC-BXZT2x	-	S-8521F40MC-BPZT2x
4.2	-	S-8521E42MC-BMBT2x	-
4.5	S-8521D45MC-BYET2x	-	-
5.0	S-8521D50MC-BYJT2x	S-8521E50MC-BMJT2x	S-8521F50MC-BQJT2x
5.2	S-8521D52MC-BYLT2x	-	-
5.3	-	S-8521E53MC-BMMT2x	-
5.5	S-8521D55MC-BYOT2x	-	S-8521F55MC-BQOT2x

Remark 1. Please contact our sales office for products with output voltage other than those specified above.

2. x: G or U

3. Please select products of environmental code = U for Sn 100%, halogen-free products.

■ Pin Configuration



Figure 3

Table 3

Pin No.	Symbol	Description
1	ON/ $\overline{\text{OFF}}$	Shutdown pin "H": Normal operation (Step-down operation) "L": Stop step-down operation (All circuits stop)
2	VSS	GND pin
3	VOUT	Output voltage monitoring pin
4	EXT	Connection pin for external transistor
5	VIN	IC power supply pin

■ Absolute Maximum Ratings

Table 4

(Ta = +25°C unless otherwise specified)

Item	Symbol	Absolute maximum rating	Unit	
VIN pin voltage	VIN	A, C, E types	VSS - 0.3 to VSS + 12.0	V
		B, D, F types	VSS - 0.3 to VSS + 18.0	V
VOUT pin voltage	VOUT	A, C, E types	VSS - 0.3 to VSS + 12.0	V
		B, D, F types	VSS - 0.3 to VSS + 18.0	V
ON/OFF pin voltage	VON/OFF	A, C, E types	VSS - 0.3 to VSS + 12.0	V
		B, D, F types	VSS - 0.3 to VSS + 18.0	V
EXT pin voltage	VEXT	VSS - 0.3 to VIN + 0.3	V	
EXT pin current	IEXT	±50	mA	
Power dissipation	PD	250 (When not mounted on board)	mW	
		600*1	mW	
Operating ambient temperature	Topr	-40 to +85	°C	
Storage temperature	Tstg	-40 to +125	°C	

*1. When mounted on board

[Mounted board]

- (1) Board size : 114.3 mm × 76.2 mm × t1.6 mm
- (2) Board name : JEDEC STANDARD51-7

Caution The absolute maximum ratings are rated values exceeding which the product could suffer physical damage. These values must therefore not be exceeded under any conditions.

(1) When mounted on board



(2) When not mounted on board



Figure 4 Power Dissipation of Package

■ Electrical Characteristics

1. A type, B type

Table 5

(Ta = +25°C unless otherwise specified)

Item	Symbol	Conditions	Min.	Typ.	Max.	Unit	Test Circuit	
Output voltage *1	V _{OUT(E)}	-	V _{OUT(S)} × 0.976	V _{OUT(S)}	V _{OUT(S)} × 1.024	V	3	
Input voltage	V _{IN}	-	A type	2.5	-	10.0	V	2
		-	B type	2.5	-	16.0	V	2
Current consumption 1	I _{SS1}	V _{OUT} = V _{OUT(S)} × 1.2	-	35	60	μA	2	
Current consumption during shutdown	I _{SSS}	V _{ON/OFF} = 0 V	-	-	0.5	μA	2	
EXT pin output current	I _{EXTH}	V _{EXT} = V _{IN} - 0.4 V	S-8520/8521x15 to 24	-2.3	-4.5	-	mA	-
			S-8520/8521x25 to 34	-3.7	-7.0	-	mA	-
			S-8520/8521x35 to 44	-5.3	-9.3	-	mA	-
			S-8520/8521x45 to 54	-6.7	-11.3	-	mA	-
	I _{EXTL}	V _{EXT} = 0.4 V	S-8520/8521x15 to 24	+4.3	+8.4	-	mA	-
			S-8520/8521x25 to 34	+7.0	+13.2	-	mA	-
			S-8520/8521x35 to 44	+9.9	+17.5	-	mA	-
			S-8520/8521x45 to 54	+12.6	+21.4	-	mA	-
Line regulation	ΔV _{OUT1}	V _{OUT(S)} ≤ 2.0 V	V _{IN} = 2.5 V to 2.94 V	-	30	60	mV	3
		V _{OUT(S)} > 2.0 V	V _{IN} = V _{OUT(S)} × 1.2 to 1.4	-	30	60	mV	3
Load regulation	ΔV _{OUT2}	Load current = 10 μA to I _{OUT} × 1.25	-	30	60	mV	3	
Output voltage temperature coefficient	$\frac{\Delta V_{OUT}}{\Delta Ta}$	Ta = -40°C to +85°C	-	±V _{OUT(S)} × 5E - 5	-	V/°C	3	
Oscillation frequency	f _{osc}	Measure waveform at EXT pin.	V _{OUT(S)} ≤ 2.4 V	144	180	216	kHz	3
			V _{OUT(S)} ≥ 2.5 V	153	180	207	kHz	3
PWM / PFM control switching duty ratio (S-8521 Series)	PFMDuty	No load, measure waveform at EXT pin.	15	25	40	%	3	
ON/OFF pin input voltage	V _{SH}	Determine oscillation at EXT pin	1.8	-	-	V	2	
ON/OFF pin input leakage current	V _{SL}	Determine oscillation stop at EXT pin	-	-	0.3	V	2	
Soft start time	I _{SH}	-	-0.1	-	0.1	μA	1	
	I _{SL}	-	-0.1	-	0.1	μA	1	
Overload detection time (A type)	t _{pro}	Time until the EXT pin reaches V _{IN} after dropping V _{OUT} to 0 V.	2.0	4.0	8.0	ms	2	
Efficiency	EFFI	-	-	93	-	%	3	

External parts Coil: Sumida Corporation CD54 (47 μH)
 Diode: Matsushita Electric Industrial Co., Ltd. MA720 (Schottky type)
 Capacitor: Matsushita Electric Industrial Co., Ltd. TE (16 V, 22 μF tantalum type)
 Transistor: Toshiba Corporation 2SA1213
 Base resistance (R_b): 0.68 kΩ
 Base capacitor (C_b): 2200 pF (Ceramic type)

Unless otherwise indicated, connect the recommended components to the IC. When V_{IN} = V_{OUT(S)} × 1.2 V (V_{IN} = 2.5 V when V_{OUT(S)} ≤ 2.0 V), I_{OUT} = 120 mA, connect the ON/OFF pin to the VIN pin.

*1. V_{OUT(S)}: Specified output voltage value, V_{OUT(E)}: Actual output voltage value

2. C type, D type

Table 6

(Ta = +25°C unless otherwise specified)

Item	Symbol	Conditions	Min.	Typ.	Max.	Unit	Test Circuit	
Output voltage*1	V _{OUT(E)}	–	V _{OUT(S)} × 0.976	V _{OUT(S)}	V _{OUT(S)} × 1.024	V	3	
Input voltage	V _{IN}	C type	2.5	–	10.0	V	2	
		D type	2.5	–	16.0	V	2	
Current consumption 1	I _{SS1}	V _{OUT} = V _{OUT(S)} × 1.2	–	10	21	μA	2	
Current consumption during shutdown	I _{SSS}	V _{ON/OFF} = 0 V	–	–	0.5	μA	2	
EXT pin output current	I _{EXTH}	V _{EXT} = V _{IN} – 0.4 V	S-8520/8521x15 to 24	–2.3	–4.5	–	mA	–
			S-8520/8521x25 to 34	–3.7	–7.0	–	mA	–
			S-8520/8521x35 to 44	–5.3	–9.3	–	mA	–
			S-8520/8521x45 to 54	–6.7	–11.3	–	mA	–
			S-8520/8521x55 to 60	–8.0	–13.3	–	mA	–
	I _{EXTL}	V _{EXT} = 0.4 V	S-8520/8521x15 to 24	+4.3	+8.4	–	mA	–
			S-8520/8521x25 to 34	+7.0	+13.2	–	mA	–
			S-8520/8521x35 to 44	+9.9	+17.5	–	mA	–
			S-8520/8521x45 to 54	+12.6	+21.4	–	mA	–
			S-8520/8521x55 to 60	+15.0	+25.1	–	mA	–
Line regulation	ΔV _{OUT1}	V _{OUT(S)} ≤ 2.0 V	V _{IN} = 2.5 V to 2.94 V	–	30	60	mV	3
		V _{OUT(S)} > 2.0 V	V _{IN} = V _{OUT(S)} × 1.2 to 1.4	–	30	60	mV	3
Load regulation	ΔV _{OUT2}	Load current = 10 μA to I _{OUT} × 1.25	–	30	60	mV	3	
Output voltage temperature coefficient	$\frac{\Delta V_{OUT}}{\Delta T_a}$	Ta = –40°C to +85°C	–	±V _{OUT(S)} × 5E – 5	–	V/°C	3	
Oscillation frequency	f _{osc}	Measure waveform at EXT pin.	V _{OUT(S)} ≤ 2.4 V	45	60	75	kHz	3
			V _{OUT(S)} ≥ 2.5 V	48	60	72	kHz	3
PWM / PFM control switching duty ratio (S-8521 Series)	PFMDuty	No load, measured waveform at EXT pin.	15	25	40	%	3	
ON/OFF pin input voltage	V _{SH}	Determine oscillation at EXT pin	1.8	–	–	V	2	
	V _{SL}	Determine oscillation stop at EXT pin	–	–	0.3	V	2	
ON/OFF pin input leakage current	I _{SH}	–	–0.1	–	0.1	μA	1	
	I _{SL}	–	–0.1	–	0.1	μA	1	
Soft start time	t _{ss}	–	6.0	12.0	24.0	ms	3	
Overload detection time (C type)	t _{pro}	Time until the EXT pin reaches V _{IN} after dropping V _{OUT} to 0 V.	7.0	14.0	28.0	ms	2	
Efficiency	EFFI	–	–	93	–	%	3	

External parts Coil: Sumida Corporation CD54 (47 μH)
 Diode: Matsushita Electric Industrial Co., Ltd. MA720 (Schottky type)
 Capacitor: Matsushita Electric Industrial Co., Ltd. TE (16 V, 22 μF tantalum type)
 Transistor: Toshiba Corporation 2SA1213
 Base resistance (R_b): 0.68 kΩ
 Base capacitor (C_b): 2200 pF (Ceramic type)

Unless otherwise indicated, connect the recommended components to the IC. When V_{IN} = V_{OUT(S)} × 1.2 V (V_{IN} = 2.5 V when V_{OUT(S)} ≤ 2.0 V), I_{OUT} = 120 mA, connect the ON/OFF pin to the VIN pin.

*1. V_{OUT(S)}: Specified output voltage value, V_{OUT(E)}: Actual output voltage value

3. E type, F type

Table 7

(Ta = +25°C unless otherwise specified)

Item	Symbol	Conditions	Min.	Typ.	Max.	Unit	Test Circuit	
Output voltage*1	$V_{OUT(E)}$	-	$V_{OUT(S)} \times 0.976$	$V_{OUT(S)}$	$V_{OUT(S)} \times 1.024$	V	3	
Input voltage	V_{IN}	-	E type	2.5	-	10.0	V	2
		F type	2.5	-	16.0	V	2	
Current consumption 1	I_{SS1}	$V_{OUT} = V_{OUT(S)} \times 1.2$	-	60	100	μA	2	
Current consumption during shutdown	I_{SSS}	$V_{ON/OFF} = 0\text{ V}$	-	-	0.5	μA	2	
EXT pin output current	I_{EXTH}	$V_{EXT} = V_{IN} - 0.4\text{ V}$	S-8520/8521x15 to 24	-2.3	-4.5	-	mA	-
			S-8520/8521x25 to 34	-3.7	-7.0	-	mA	-
			S-8520/8521x35 to 44	-5.3	-9.3	-	mA	-
			S-8520/8521x45 to 54	-6.7	-11.3	-	mA	-
			S-8520/8521x55 to 60	-8.0	-13.3	-	mA	-
	I_{EXTL}	$V_{EXT} = 0.4\text{ V}$	S-8520/8521x15 to 24	+4.3	+8.4	-	mA	-
			S-8520/8521x25 to 34	+7.0	+13.2	-	mA	-
			S-8520/8521x35 to 44	+9.9	+17.5	-	mA	-
			S-8520/8521x45 to 54	+12.6	+21.4	-	mA	-
			S-8520/8521x55 to 60	+15.0	+25.1	-	mA	-
Line regulation	ΔV_{OUT1}	$V_{OUT(S)} \leq 2.0\text{ V}$	$V_{IN} = 2.5\text{ V to }2.94\text{ V}$	-	30	60	mV	3
		$V_{OUT(S)} > 2.0\text{ V}$	$V_{IN} = V_{OUT(S)} \times 1.2\text{ to }1.4$	-	30	60	mV	3
Load regulation	ΔV_{OUT2}	Load current = 10 μA to $I_{OUT} \times 1.25$	-	30	60	mV	3	
Output voltage temperature coefficient	$\frac{\Delta V_{OUT}}{\Delta Ta}$	Ta = -40°C to +85°C	-	$\pm V_{OUT(S)} \times 5E - 5$	-	V/°C	3	
Oscillation frequency	f_{osc}	Measure waveform at EXT pin.	$V_{OUT(S)} \leq 2.4\text{ V}$	225	300	375	kHz	3
			$V_{OUT(S)} \geq 2.5\text{ V}$	240	300	360	kHz	3
PWM / PFM control switching duty ratio (S-8521 Series)	PFMDuty	No load, measure waveform at EXT pin.	15	25	40	%	3	
ON/OFF pin input voltage	V_{SH}	Determine oscillation at EXT pin	1.8	-	-	V	2	
	V_{SL}	Determine oscillation stop at EXT pin	-	-	0.3	V	2	
ON/OFF pin input leakage current	I_{SH}	-	-0.1	-	0.1	μA	1	
	I_{SL}	-	-0.1	-	0.1	μA	1	
Soft start time	t_{ss}	-	2.0	4.5	9.2	ms	3	
Overload detection time (E type)	t_{pro}	Time until the EXT pin reaches V_{IN} after dropping V_{OUT} to 0 V.	1.3	2.6	4.5	ms	2	
Efficiency	EFFI	-	-	90	-	%	3	

External parts Coil: Sumida Corporation CD54 (47 μH)
 Diode: Matsushita Electric Industrial Co., Ltd. MA720 (Schottky type)
 Capacitor: Matsushita Electric Industrial Co., Ltd. TE (16 V, 22 μF tantalum type)
 Transistor: Toshiba Corporation 2SA1213
 Base resistance (R_b): 0.68 kΩ
 Base capacitor (C_b): 2200 pF (Ceramic type)

Unless otherwise indicated, connect the recommended components to the IC. When $V_{IN} = V_{OUT(S)} \times 1.2\text{ V}$ ($V_{IN} = 2.5\text{ V}$ when $V_{OUT(S)} \leq 2.0\text{ V}$), $I_{OUT} = 120\text{ mA}$, connect the ON/OFF pin to the VIN pin.

*1. $V_{OUT(S)}$: Specified output voltage value, $V_{OUT(E)}$: Actual output voltage value

■ Test Circuit

1.



Figure 5

2.



Figure 6

3.



Figure 7

■ Operation

1. Switching control method

1.1 PWM control (S-8520 Series)

The S-8520 Series is a DC-DC converter using a pulse width modulation method (PWM) and features a low current consumption.

In conventional PFM DC-DC converters, pulses are skipped when the output load current is low, causing a fluctuation in the ripple frequency of the output voltage, resulting in an increase in the ripple voltage.

The switching frequency does not change, although the pulse width changes from 0 to 100% corresponding to each load current. The ripple voltage generated from switching can thus be removed easily through a filter because the switching frequency is constant. And the ripple voltage will be skipped to be low current consumption when the pulse width is 0% or it is no load, input current voltage is high.

1.2 PWM / PFM switching control (S-8521 Series)

S-8521 Series is a DC-DC converter that automatically switches between a pulse width modulation method (PWM) and a pulse frequency modulation method (PFM), depending on the load current, and features low current consumption.

The S-8521 Series operates under PWM control with the pulse width duty changing from 25 to 100% in a high output load current area.

The S-8521 Series operates under PFM control with the pulse width duty fixed at 25%, and pulses are skipped according to the load current. The oscillation circuit thus oscillates intermittently so that the resultant lower self current consumption prevents a reduction in the efficiency at a low load current. The switching point from PWM control to PFM control depends on the external devices (coil, diode, etc.), input voltage and output voltage. The S-8521 Series is an especially highly efficient DC-DC converter at an output current around 100 μ A.

2. Soft start function

The S-8520/8521 Series has a built-in soft start-circuit. This circuit enables the output voltage (V_{OUT}) to rise gradually over the specified soft start time (t), when power-on or when the ON/\overline{OFF} pin is at the "H" level. This prevents the output voltage from overshooting.

However, the soft-start function of this IC is not able to perfectly prevent a rush current from flowing to the load (Refer to **Figure 8**). Since this rush current depends on the input voltage and load conditions, Perform sufficient evaluation with actual device for design.



Figure 8 Waveforms of output voltage and rush current at soft start

3. ON/\overline{OFF} pin (Shutdown pin)

The ON/\overline{OFF} pin stops or starts step-up operation.

Setting the ON/\overline{OFF} pin to the "L" level stops operation of all the internal circuits and reduces current consumption significantly. The EXT pin's voltage is set to the V_{IN} voltage level so that the switching transistor is turned off.

Do not use the ON/\overline{OFF} pin in a floating state because it has the structure shown in **Figure 9** and is not pulled up or pulled down internally. Do not apply a voltage of between 0.3 V and 1.8 V to the ON/\overline{OFF} pin because applying such a voltage increases the current consumption. When not using the ON/\overline{OFF} pin, connect it to the V_{IN} pin.

Table 8

ON/\overline{OFF} pin	CR Oscillation Circuit	Output voltage
"H"	Operation	Set value
"L"	Stop	V_{SS}



Figure 9

4. Overload protection circuit (A, C, E types)

The A, C and E types of the S-8520/8521 Series have a built-in overload protection circuit.

If the output voltage drops under the overload status, the maximum duty status (100%) continues. If this 100% duty status lasts longer than the overload detection time (t_{pro}), the circuit keeps the EXT pin at "H" to protect the switching transistor and inductor. When the overload protection circuit is functioning, the soft start works in the IC for the reference voltage, and the reference voltage rises slowly from 0 V. The reference voltage and the feedback voltage obtained by dividing the output voltage are compared to each other. While the reference voltage is low, the EXT pin keeps "H" and oscillation stops. If the reference voltage rises and exceeds the feedback voltage, oscillation restarts.

After oscillation is restarted, if a load is heavy and the EXT pin keeps the "L" level longer than the overload detection time (t_{pro}), the circuit operates again, and the IC enters the intermittent operation mode by repeating the action described above. Once the overload state is off, the IC restarts the normal operation.



Figure 10 Waveforms at EXT pin when the overload protection circuit operates

5. 100% duty cycle

The S-8520/8521 Series operates with a maximum duty cycle of 100%. When using the B, D and F types products, which do not have the overload protection circuit, the switching transistor keeps ON continually to supply current to the load, even in cases where the input voltage drops to the set value of output voltage or less. The output voltage in this case is; the voltage subtracting both of the inductance's DC resistance and the voltage drop by the switching resistor's ON-resistance, from the input voltage.

The A, C and E types that have the overload protection circuit cannot be used for continually supplying current to the load, as described above, because these types enter the intermittent operation mode by the overload protection circuit's operation, when 100% duty lasts longer than the overload detection time (t_{pro}).

■ Selection of Products and External Parts

1. Method for selecting series products

The S-8520/8521 Series is classified into 12 types, according to the control systems (PWM control and PWM / PFM switching control), the different oscillation frequencies, and set-up of an overload protection circuit. Please select the type for your application according to the following features.

1.1 Control systems

Two different control systems are available: PWM control system (S-8520 Series) and PWM / PFM switching control system (S-8521 Series).

For applications for which the load current greatly differs between standby and operation, if the efficiency during standby is important, applying the PWM/PFM switching system (S-8321 Series) realizes high efficiency during standby.

For applications for which switching noise is critical, applying the PWM control system (S-8320 Series) whereby switching frequency does not change due to load current allows the ripple voltage to be easily suppressed by using a filter.

1.2 Oscillation frequencies

Either oscillation frequency, 180 kHz (A and B types), 60 kHz (C and D types), or 300 kHz (E and F types), can be selected.

The A, B, E and F types have high oscillation frequency, low ripple voltage and excellent transient response characteristics. A small inductance can be used for these types because the peak current is low when inducing the same load current. Use of small output capacitors is effective for downsizing devices.

The C and D types, whereby lower oscillation frequency realizes smaller self-consumption current, are highly efficient under light loads. In particular, the D type, when combined with a PWM/PFM switching control system, drastically improves the operation efficiency when the output load current is approximately 100 mA.

1.3 Overload protection circuit

Types are selectable the S-8520/8521 Series with the overload protection circuit (A, C and E types) or without the overload protection circuit (B, D and F types).

By the S-8520/8521 Series with the overload protection circuit (A, C and E types), the switching components and inductor can be protected because the overload protection circuit works and is set to the intermittent mode, in case of overload or load short-circuit.

But in case of supplying current to load by using 100% duty cycle, select the S-8520/8521 Series without the overload protection circuit (B, D and F types), according to the conditions of application.

The operation voltage differs in 10 V (A, B and E types) or 16 V (B, D and F types) whether the overload protection circuit is available or not.

Table 9 shows items for selecting the type according to the requirements of application. Select it matching the marks (○) for your requirement.

Table 9

Item	S-8520 Series						S-8521 Series					
	A	B	C	D	E	F	A	B	C	D	E	F
The need of overload protection circuit	☆		☆		☆		☆		☆		☆	
Input voltage exceeds 10 V		☆		☆		☆		☆		☆		☆
Focusing on efficiency of light load status (1 mA or less)							○	○	○	○		
Using with middle load current (about 200 mA)	○	○			○	○			○	○		
Using with large load current (about 1 A)	○	○			○	○	○	○			○	○
Focusing on the low ripple voltage	○	○			◎	◎	○	○			◎	◎
Focusing on downsizing external parts	○	○			◎	◎	○	○			◎	◎

Remark ☆: Indispensable condition
 ○: Superiority of requirement
 ◎: Particularly superiority of requirement

2. Inductor

The inductance value (L value) has a strong influence on the maximum output current (I_{OUT}) and efficiency (η).

The peak current (I_{PK}) increases by decreasing L value and the stability of the circuit improves and I_{OUT} increases. If L value is decreased, the efficiency falls causing a decline in the current drive capacity for the switching transistor, and I_{OUT} decreases.

The loss of I_{PK} by the switching transistor decreases by increasing L and the efficiency becomes the maximum at a certain L value. Further increasing L value decreases the efficiency due to the loss of the direct current resistance of the coil. I_{OUT} also decreases.

For the S-8520/8521 Series, increasing the inductance value, the output voltage may be unstable in some cases, depending on the conditions of the input voltage, output voltage, and the load current. Perform sufficient evaluation under the actual condition and decide an optimum inductance value.

The recommended inductances are 47 μH for A, B, C, D types and 22 μH for E, F types.

Be careful of the allowable inductor current when choosing an inductor. Exceeding the allowable current of the inductor causes magnetic saturation, much lower efficiency and destruction of the IC chip due to a large current.

Choose an inductor so that I_{PK} does not exceed the allowable current. I_{PK} in continuous mode is calculated by the following equation:

$$I_{PK} = I_{OUT} + \frac{(V_{OUT} + V_F^{*2}) \times (V_{IN} - V_{OUT})}{2 \times f_{osc}^{*1} \times L \times (V_{IN} + V_F^{*2})}$$

*1. f_{osc} : Oscillation frequency

*2. V_F : Forward voltage of the diode

3. Diode

Use an external diode that meets the following requirements :

- Its forward voltage is low (Schottky barrier diode is recommended).
- Its switching speed is high (50 ns max.).
- Its reverse direction voltage is higher than V_{IN} .
- Its current rating is higher than I_{PK} .

4. Capacitors (C_{IN} , C_{OUT})

A capacitor for the input (C_{IN}) improves efficiency by reducing power impedance and stabilizing the input current.

Select the C_{IN} value according to impedance of the power supply to be used. Approximately 47 to 100 μF is recommended for the capacitor depending on impedance of the power source and load current value.

For a capacitor for output (C_L), select a large capacitance with low ESR (Equivalent Series Resistance) for smoothing the ripple voltage. However, capacitor with extremely small ESR such as ceramic capacitor (about 0.3 Ω or less) may destabilize the output voltage, according to the conditions of input and output voltages. A tantalum electrolyte capacitor is recommended. 47 μF to 100 μF is recommended for the capacitor.

5. External transistor

Enhancement (Pch) MOS FET or bipolar (PNP) MOS FET can be used for external transistor.

5.1 Enhancement (Pch) MOS FET type

The EXT pin of the S-8520/8521 Series is capable of directly driving a Pch MOS FET with a gate capacity around 1000 pF.

When using a Pch MOS FET, 2 to 3% higher efficiency is provided because its switching speed is faster and it does not cause power dissipation, compared to PNP bipolar transistors.

The important parameters in selecting MOS FETs are the threshold voltage, the breakdown voltage between gate and source, the breakdown voltage between drain and source, the total gate capacity, the on-resistance, and the current ratings.

The EXT pin swings from voltages between V_{IN} to V_{SS} . If the input voltage is low, use a MOS FET with the low threshold voltage. If the input voltage is high, use a MOS FET having the breakdown voltage between gate and source higher several volts than the input voltage.

Immediately after the power-on or power-off (stopping the step-down operation), the input voltage will be applied between drain and source of the MOS FET. Use the breakdown voltage between drain and source also higher several volts than the input voltage.

The total gate capacity and the on-resistance affect efficiency.

Power dissipation when charging and discharging the gate capacity by switching operation affects efficiency, in the area of low load current, as the total gate capacity is larger and the input voltage is higher. Select a MOS FET with a small total gate capacity for efficiency at light load.

In the area of large load current, efficiency is affected by power dissipation caused by MOS FET's on-resistance. For efficiency at large load, select a MOS FET having as low on-resistance as possible.

As for the current rating, select a MOS FET having the maximum continuous drain current rating higher than I_{PK} .

For reference, this document has the data of efficiency. TM6201 by Toyota Industries Corporation for applications with an input voltage of 10 V or less, IRF7606 by International Rectifier Corporation Japan for applications with an input voltage over 10 V (Refer to "■ Reference Data").

5.2 Bipolar PNP type

Figure 11 shows the sample of circuit diagram using Toshiba Corporation 2SA1213 as the bipolar transistor (PNP). The h_{FE} value and the R_b value of that bipolar transistor determine the driving capacity, which is used for increasing the output current.

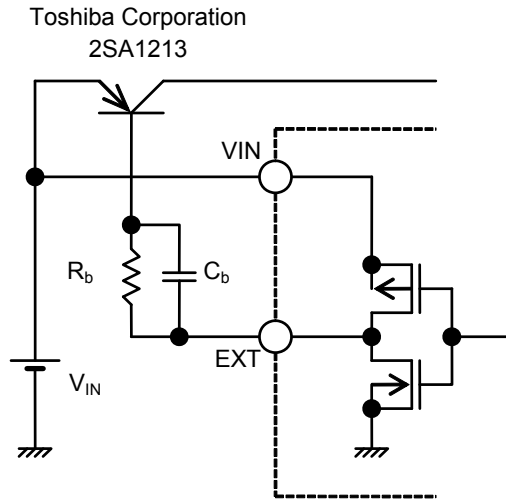

Figure 11

The R_b value is given by the following equation:

$$R_b = \frac{V_{IN} - 0.7}{I_b} - \frac{0.4}{|I_{EXTL}|}$$

Calculate the necessary base current (I_b) using the (h_{FE}) value of bipolar transistor by the equation, $I_b = \frac{I_{PK}}{h_{FE}}$, and select a smaller R_b value.

A small R_b value increases the output current, but it also decreases efficiency. Determine the optimum value through experiment, since the base current may flow on the pulse, or voltage may drop due to wiring resistance. In addition, if speed-up capacitor C_b is connected in parallel with resistor R_b , as shown in **Figure 11**, the loss in switching will be reduced, leading to higher efficiency.

Determine the C_b value using the following equation:

$$C_b \leq \frac{1}{2 \times \pi \times R_b \times f_{osc} \times 0.7}$$

Select the C_b value after performing sufficient evaluation since the optimum C_b value differs depending upon the characteristics of the bipolar transistor.

■ Standard Circuits

1. Using a bipolar transistor

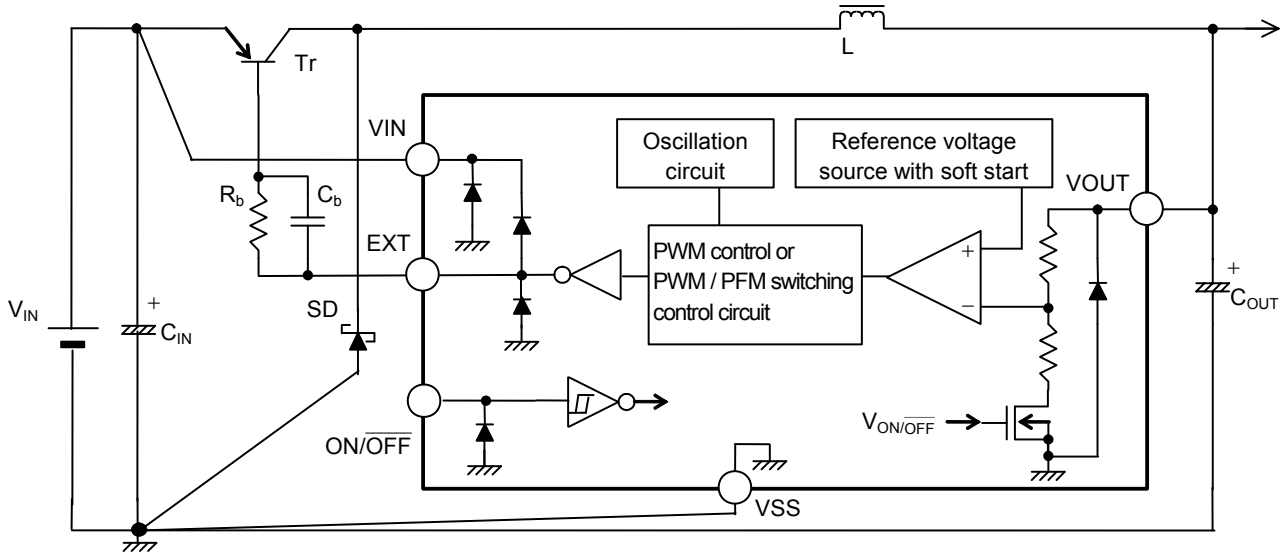

Figure 12

2. Using a Pch MOS FET transistor

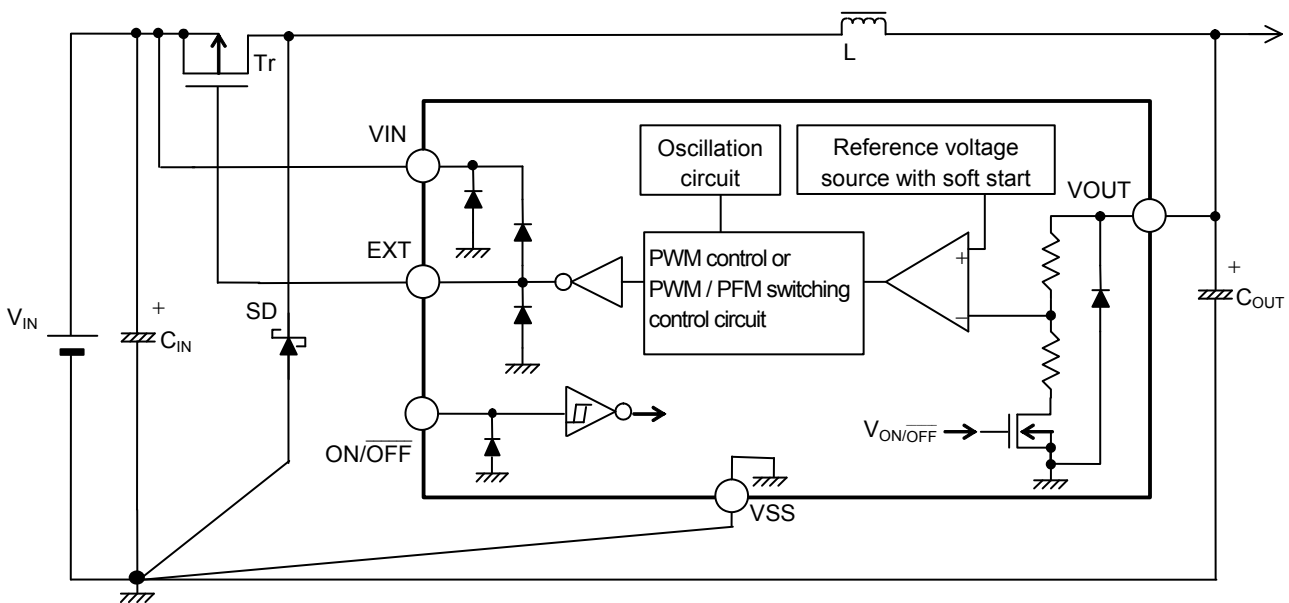

Figure 13

Caution The above connection diagram and constant will not guarantee successful operation. Perform through evaluation using the actual application to set the constant.

■ Precautions

- Mount the external capacitors, the diode and the coil as close as possible to the IC, and secure grounding at a single location.
- Characteristics ripple voltage and spike noise occur in IC containing switching regulators. Moreover, rush current flows at the time of a power supply injection. Because these largely depend on the coil, the capacitor and impedance of power supply used, fully check them using an actually mounted model.
- The overload protection circuit of this IC performs the protective function by detecting the maximum duty time (100 %). In choosing the components, make sure that over currents generated by short-circuits in the load, etc., will not surpass the allowable dissipation of the switching transistor and inductor.
- Make sure that dissipation of the switching transistor (especially at a high temperature) does not exceed the allowable dissipation of the package.
- Do not apply an electrostatic discharge to this IC that exceeds the performance ratings of the built-in electrostatic protection circuit.
- ABLIC Inc. claims no responsibility for any and all disputes arising out of or in connection with any infringement by products including this IC of patents owned by a third party.

Application Circuits

1. External adjustment of output voltage

In the S-8550/8521 Series, by adding external resistors (R_A , R_B) and a capacitor (C_{FB}), the output voltage can be adjusted or be set freely in the range of 1.5 to 6.0 V, as shown in **Figure 14**. Temperature gradient can be given by inserting a thermistor in series to R_A and R_B .

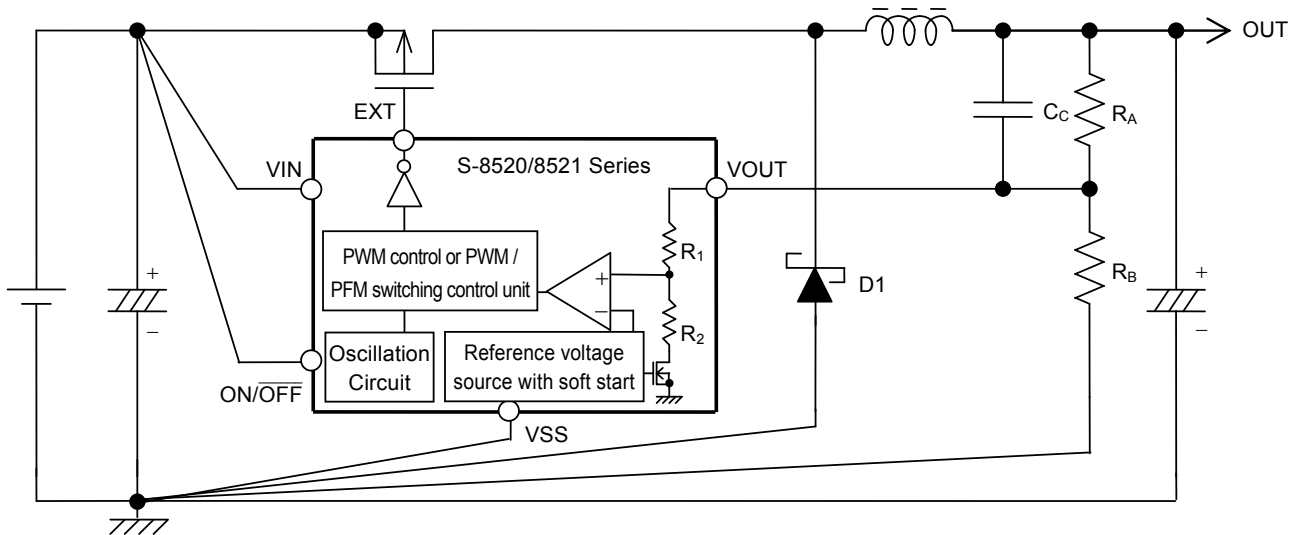

Figure 14

Caution The above connection diagram and constant will not guarantee successful operation. Perform through evaluation using the actual application to set the constant.

The S-8520/8521 Series have an internal impedance of R_1 and R_2 between the VOUT pin and the VSS pin, as shown in **Figure 14**.

Therefore, OUT (the output voltage) is determined by the output voltage value (V_{OUT}) of the S-8520/8521 Series, and the ratio of the parallel resistance value of external resistance (R_B) and internal resistances ($R_1 + R_2$) of the IC, to external resistance (R_A). The output voltage is expressed by the following equation:

$$OUT = V_{OUT} + V_{OUT} \times R_A \div (R_B //^{*1}(R_1 + R_2))$$

*1. // shows the combined resistance in parallel.

The voltage accuracy of the OUT set by resistances (R_A and R_B) is not only affected by the IC's output voltage accuracy ($V_{OUT} \pm 2.4\%$), but also by the absolute precision of external resistances (R_A and R_B) in use and the absolute value deviations of internal resistances (R_1 and R_2) in the IC.

Let us designate the maximum deviations of the absolute value of R_A and R_B by $R_A \text{ max.}$ and $R_B \text{ max.}$, respectively, the minimum deviations by $R_A \text{ min.}$ and $R_B \text{ min.}$, respectively, and the maximum and minimum deviations of the absolute value of R_1 and R_2 in the IC by $(R_1 + R_2) \text{ max.}$ and $(R_1 + R_2) \text{ min.}$, respectively. Then, the minimum deviation value OUT min. and the maximum deviation value OUT max. of the OUT are expressed by the following equations:

$$OUT \text{ min.} = V_{OUT} \times 0.976 + V_{OUT} \times 0.976 \times R_A \text{ min.} \div (R_B \text{ max.} // (R_1 + R_2) \text{ max.})$$

$$OUT \text{ max.} = V_{OUT} \times 1.024 + V_{OUT} \times 1.024 \times R_A \text{ max.} \div (R_B \text{ min.} // (R_1 + R_2) \text{ min.})$$

The voltage accuracy of the OUT cannot be made higher than the output voltage accuracy ($V_{OUT} \pm 2.4\%$) of the IC itself, without adjusting the R_A and R_B involved. The closer the voltage value of the output OUT and the output voltage value (V_{OUT}) of the IC are brought to one other, the more the output voltage remains immune to deviations in the absolute accuracy of R_A and R_B and the absolute value of R_1 and R_2 in the IC. In particular, to suppress the influence of deviations in R_1 and R_2 in the IC, a major contributor to deviations in the OUT, the R_A and R_B must be limited to a much smaller value than that of R_1 and R_2 in the IC.

On the other hand, a reactive current flows through R_A and R_B . This reactive current must be reduced to a negligible value with respect to the load current in the actual use of the IC so that the efficiency characteristics will not be degraded. This requires that the value of R_A and R_B be made sufficiently large.

However, too large a value (more than 1 M Ω) for the R_A and R_B would make the IC vulnerable to external noise. Check the influence of this value on actual equipment.

There is a tradeoff between the voltage accuracy of the OUT and the reactive current. This should be taken into consideration based on the requirements of the intended application.

Deviations in the absolute value of the internal resistances (R_1 and R_2) in the IC vary with the output voltage of the S-8520/8521 Series, and are broadly classified as follows:

Table 10

Output voltage	Deviations in the absolute value of R_1 and R_2 in the IC
1.5 V to 2.0 V	5.16 M Ω to 28.9 M Ω
2.1 V to 2.5 V	4.44 M Ω to 27.0 M Ω
2.6 V to 3.3 V	3.60 M Ω to 23.3 M Ω
3.4 V to 4.9 V	2.44 M Ω to 19.5 M Ω
5.0 V to 6.0 V	2.45 M Ω to 15.6 M Ω

When a value of $R_1 + R_2$ given by the equation indicated below is taken in calculating the voltage value of the output OUT, a median voltage deviation will be obtained for the OUT.

$$R_1 + R_2 = 2 \div (1 \div \text{maximum deviation in absolute value of } R_1 \text{ and } R_2 + 1 \div \text{minimum deviation in absolute value of } R_1 \text{ and } R_2)$$

Moreover, add a capacitor (C_C) in parallel to the external resistance (R_A) in order to avoid output oscillations and other types of instability (Refer to **Figure 14**).

Make sure that C_C is larger than the value given by the following equation:

$$C_C [\text{F}] \geq 1 \div (2 \times \pi \times R_A [\Omega] \times 7.5 \text{ kHz})$$

If a large C_C value is selected, a longer soft start time than the one set up in the IC will be set.

Caution The above connection diagram and constant will not guarantee successful operation. Perform through evaluation using the actual application to set the constant.

■ Characteristics (Typical Data)

1. Examples of major parameters characteristics

(1) Current consumption (I_{SS1})-Input voltage (V_{IN})

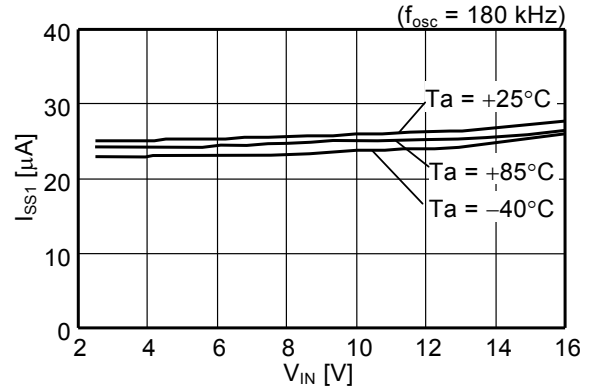

(2) Oscillation frequency (f_{osc})-Input voltage (V_{IN})

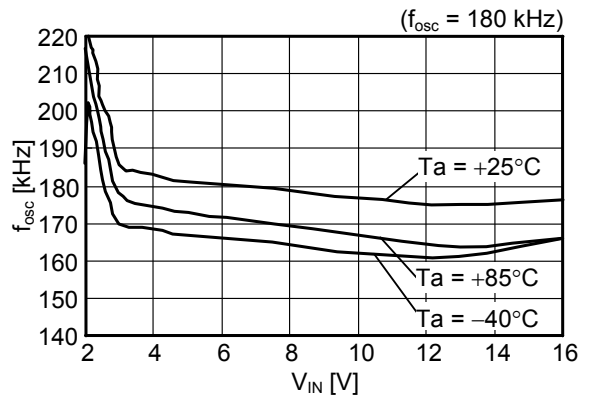

**(3) EXT pin output current “H” (I_{EXTH})-
Input voltage (V_{IN})**



**(4) EXT pin output current “L” (I_{EXTL})-
Input voltage (V_{IN})**



(5) Soft start time (t_{SS})-Input voltage (V_{IN})

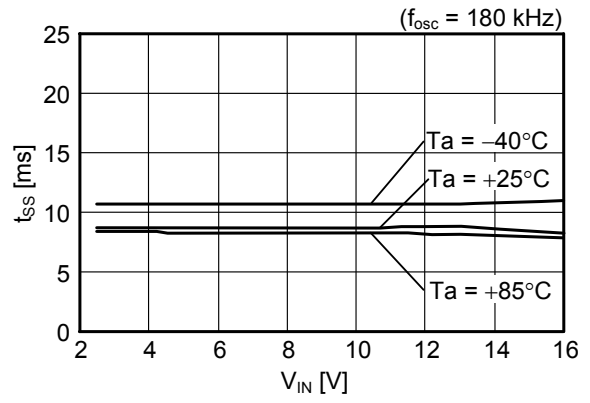
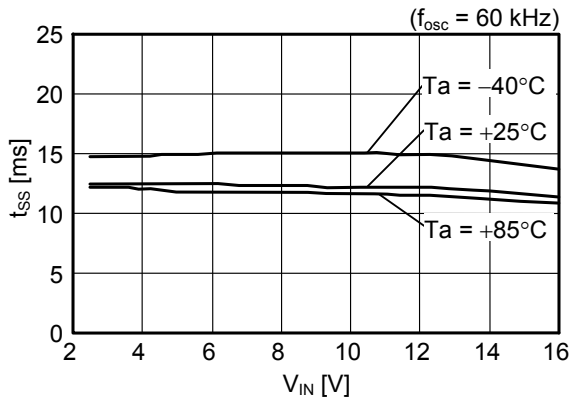

(6) Overload detection time (t_{pro})-Input voltage (V_{IN})



(7) ON/OFF pin input voltage "H" (V_{SH})-
Input voltage (V_{IN})



(8) ON/OFF pin input voltage "L" (V_{SL})-
Input voltage (V_{IN})



(9) Output voltage (V_{OUT})-Input voltage (V_{IN})

S-8521B30MC



S-8521B50MC



S-8521F33MC



S-8521F50MC

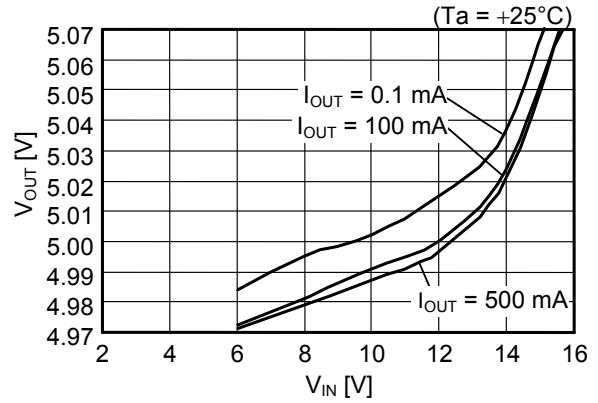

2. Transient Response Characteristics

2.1 Power-on (I_{OUT} : no load)

(1) S-8520/8521C30MC

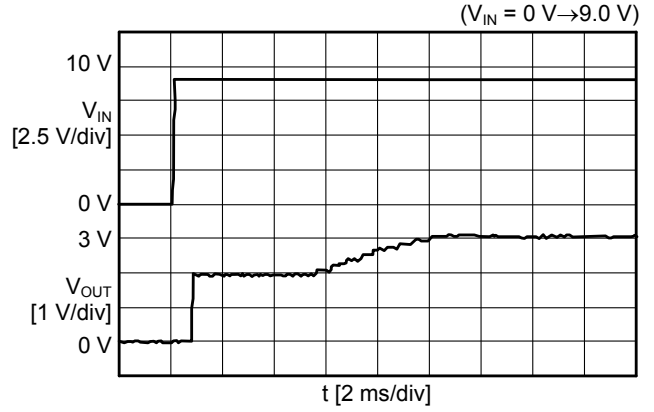
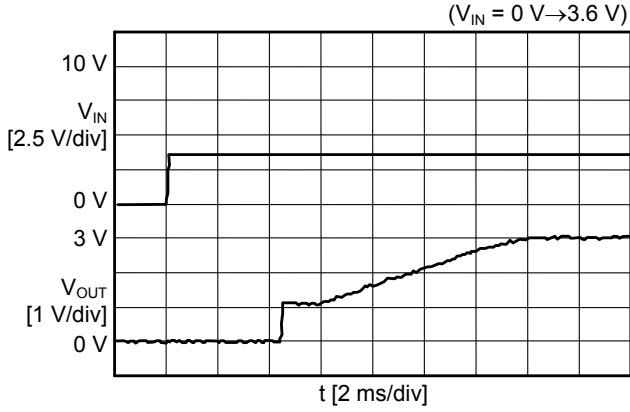

(2) S-8520/8521A30MC

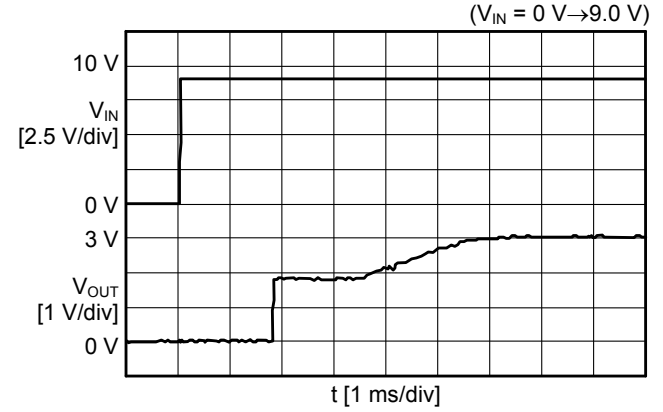
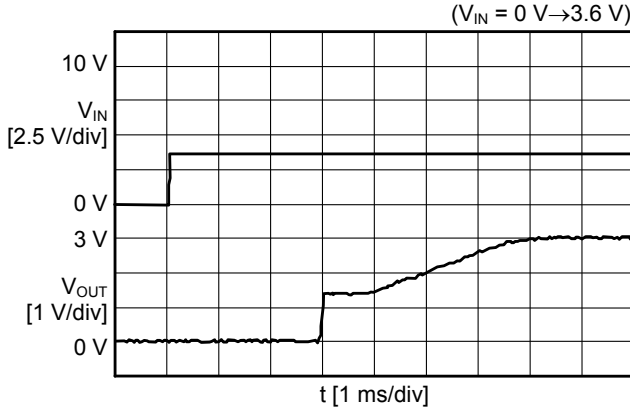

(3) S-8520/8521E33MC

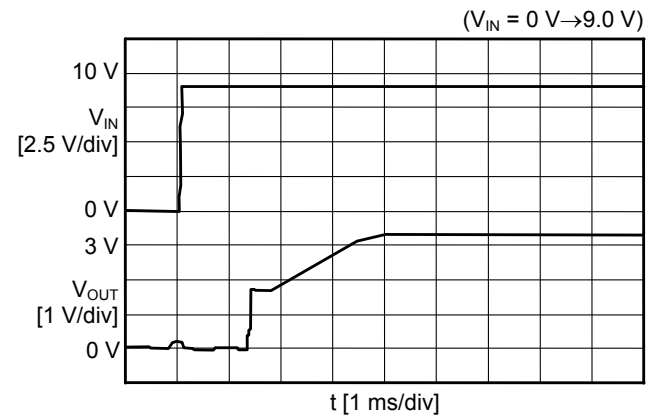
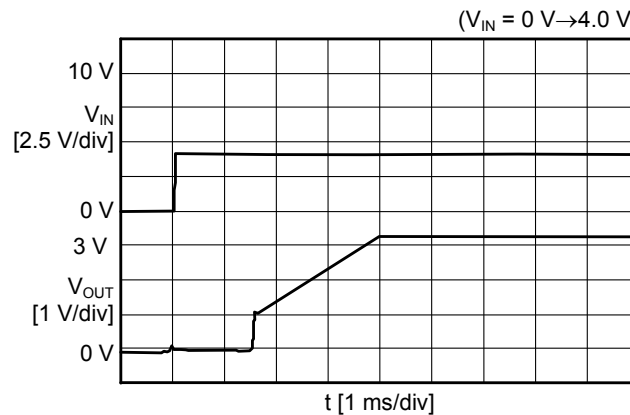

2.2 Shutdown pin response ($V_{ON/OFF} = 0\text{ V} \rightarrow 1.8\text{ V}$, $I_{OUT} = \text{No load}$)

(1) S-8520/8521C30MC



(2) S-8520/8521A30MC



(3) S-8520/8521E33MC



2.3 Supply voltage variation ($V_{IN} = 4\text{ V} \rightarrow 9\text{ V}$, $9\text{ V} \rightarrow 4\text{ V}$)

(1) S-8520/8521C30MC



(2) S-8520/8521C30MC



(3) S-8520/8521A30MC



(4) S-8520/8521A30MC



(5) S-8520/8521E33MC



(6) S-8520/8521E33MC



2.4 Load variation

(1) S-8520/8521C30MC

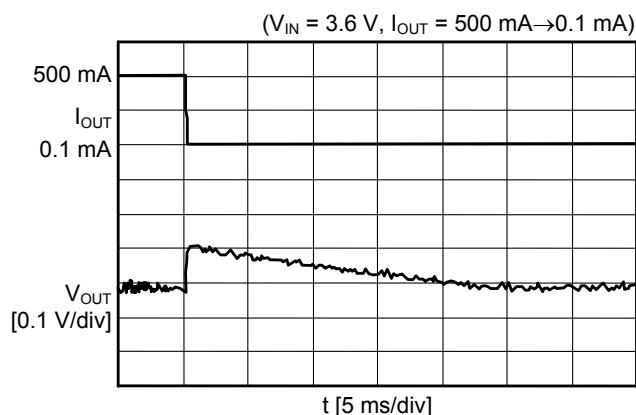
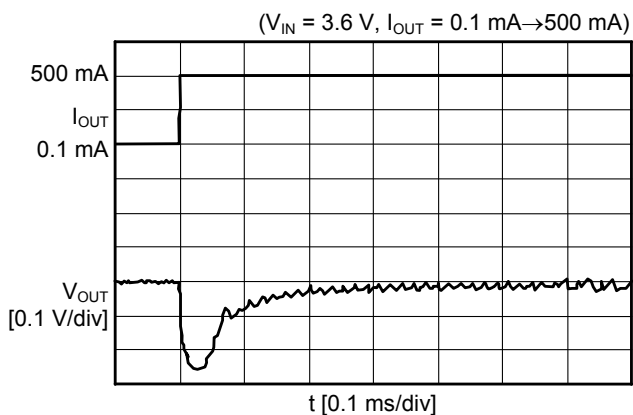

(2) S-8520/8521A30MC

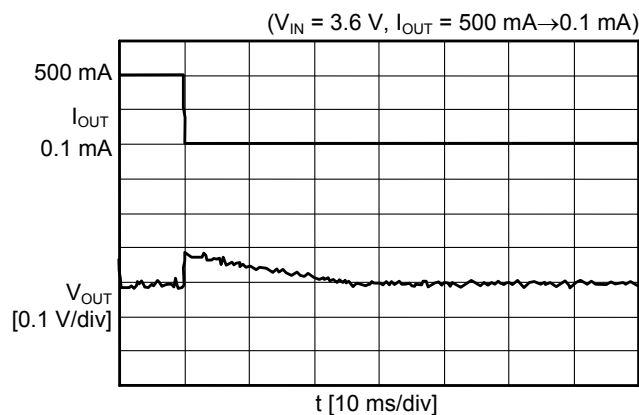
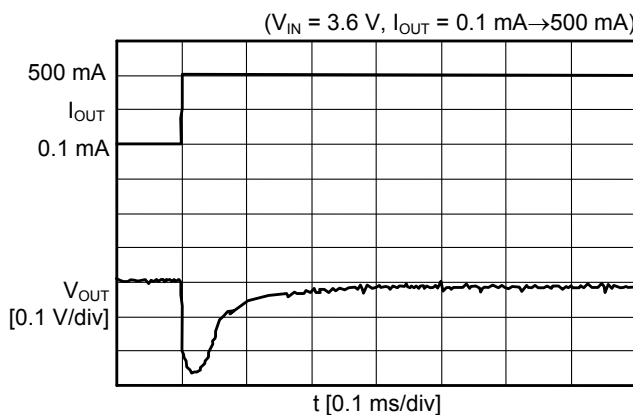

(3) S-8520/8521E33MC

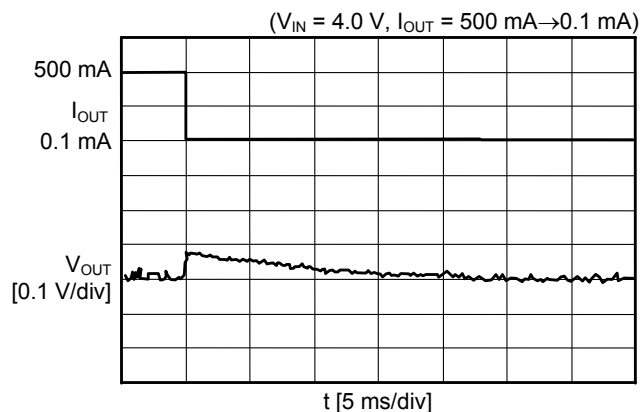
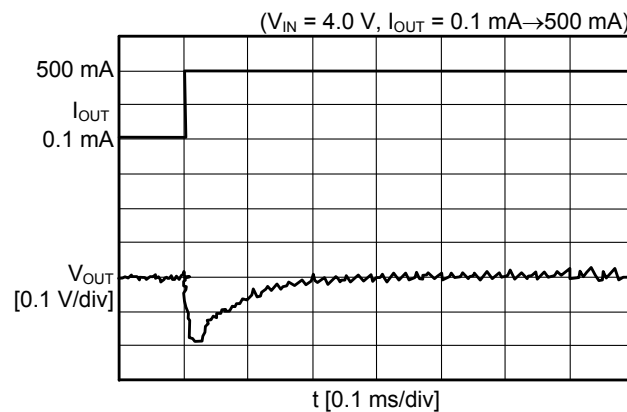

■ Reference Data

This reference data is intended to help you select peripheral components to be externally connected to the IC. Therefore, this information provides recommendations on external components selected with a view to accommodating a wide variety of IC applications. Characteristic data is duly indicated in the table below.

Table 11 External parts for efficiency data

Product name	Output voltage	Inductor	Transistor	Diode	Output capacitor	Application
S-8520B30MC	3.0 V	CD105 / 47 μ H	TM6201	MA737	47 μ F	$I_{OUT} \leq 1 A, V_{IN} \leq 10 V$
S-8520F33MC	3.3 V	D62F / 22 μ H		MA720	22 μ F	$I_{OUT} \leq 0.5 A, V_{IN} \leq 10 V$
S-8520F33MC		CDH113 / 22 μ H	IRF7606	MA737		$I_{OUT} \leq 1 A, V_{IN} \leq 16 V$
S-8521D30MC	3.0 V	CD54 / 47 μ H	TM6201	MA720	47 μ F \times 2	$I_{OUT} \leq 0.5 A, V_{IN} \leq 10 V,$ With equipment standby mode
S-8521D30MC			IRF7606			$I_{OUT} \leq 0.5 A, V_{IN} \leq 16 V,$ With equipment standby mode
S-8521B30MC		CD105 / 47 μ H	TM6201	MA737	47 μ F	$I_{OUT} \leq 1 A, V_{IN} \leq 10 V,$ With equipment standby mode
S-8521B30MC			IRF7606			$I_{OUT} \leq 1 A, V_{IN} \leq 16 V,$ With equipment standby mode
S-8521F33MC	3.3 V	D62F / 22 μ H	TM6201	MA720	22 μ F	$I_{OUT} \leq 0.5 A, V_{IN} \leq 10 V,$ With equipment standby mode
S-8521F33MC		CDH113 / 22 μ H	IRF7606	MA737		$I_{OUT} \leq 1 A, V_{IN} \leq 16 V,$ With equipment standby mode
S-8520B50MC	5.0 V	CD54 / 47 μ H	TM6201	MA720	47 μ F	$I_{OUT} \leq 0.5 A, V_{IN} \leq 10 V$
S-8520B50MC		CD105 / 47 μ H	IRF7606	MA737		$I_{OUT} \leq 1 A, V_{IN} \leq 16 V$
S-8520F50MC		D62F / 22 μ H	TM6201	MA720	22 μ F	$I_{OUT} \leq 0.5 A, V_{IN} \leq 10 V$
S-8520F50MC		CDH113 / 22 μ H	IRF7606	MA737		$I_{OUT} \leq 1 A, V_{IN} \leq 16 V$
S-8521D50MC		CD54 / 47 μ H	TM6201	MA720	47 μ F \times 2	$I_{OUT} \leq 0.5 A, V_{IN} \leq 10 V,$ With equipment standby mode
S-8521D50MC		CD105 / 47 μ H	IRF7606	MA737		$I_{OUT} \leq 1 A, V_{IN} \leq 16 V,$ With equipment standby mode
S-8521B50MC		CD54 / 47 μ H	TM6201	MA720	47 μ F	$I_{OUT} \leq 0.5 A, V_{IN} \leq 10 V,$ With equipment standby mode
S-8521B50MC		CD105 / 47 μ H	IRF7606	MA737		$I_{OUT} \leq 1 A, V_{IN} \leq 16 V,$ With equipment standby mode
S-8521F50MC		D62F / 22 μ H	TM6201	MA720	22 μ F	$I_{OUT} \leq 0.5 A, V_{IN} \leq 10 V,$ With equipment standby mode
S-8521F50MC		CDH113 / 22 μ H	IRF7606	MA737		$I_{OUT} \leq 1 A, V_{IN} \leq 16 V,$ With equipment standby mode

Table 12 External parts for Ripple data

Product name	Output voltage	Inductor	Transistor	R _b	C _b	Diode	Output capacitor
S-8520D30MC	3.0 V	CD105 / 47 μH	2SA1213	680 Ω	2200 pF	MA720	47 μF × 2
S-8521D30MC							22 μF × 2
S-8520B30MC							
S-8521B30MC							
S-8520F33MC	3.3 V	CDH113 / 22 μH	IRF7606	–	–	MA737	22 μF
S-8521F33MC				–	–		
S-8520D50MC	5.0 V	CD105 / 47 μH	2SA1213	680 Ω	2200 pF	MA720	47 μF × 2
S-8521D50MC							22 μF × 2
S-8520B50MC							
S-8521B50MC							
S-8520F50MC		CDH113 / 22 μH	IRF7606	–	–	MA737	22 μF
S-8521F50MC				–	–		

Table 13 Performance Data

Component	Product name	Manufacturer name	“L” value	DC resistance	Maximum allowable current	Diameter	Height
Inductor	CD54	Sumida Corporation	47 μH	0.37 Ω	0.72 A	5.8 mm	4.5 mm
	CD105			0.17 Ω	1.28 A	10.0 mm	5.4 mm
	CDH113		22 μH	0.09 Ω	1.44 A	11.0 mm	3.7 mm
	D62F	Toko Ink.		0.25 Ω	0.70 A	6.0 mm	2.7 mm
Diode	MA720	Matsushita Electric Industrial Co., Ltd.	Forward current 500 mA (at V _F = 0.55 V)				
	MA737	Matsushita Electric Industrial Co., Ltd.	Forward current 1.5 A (at V _F = 0.5 V)				
Output capacity	F93	Nichicon Corporation	–				
	TE	Matsushita Electric Industrial Co., Ltd.	–				
External transistor (Bipolar PNP)	2SA1213	Toshiba Corporation	V _{CEO} : 50 V max., I _C : –2 A max., h _{FE} : 120 to 240, SOT-89-3 package				
External transistor (MOS FET)	TM6201	Toyota Industries Corporation	V _{GS} : 12 V max., I _D : –2 A max., V _{th} : –0.7 V min., C _{iss} : 320 pF typ., R _{on} : 0.25 Ω max. (V _{GS} = –4.5 V), SOT-89-3 package				
	IRF7606	International Rectifier Corporation	V _{GS} : 20 V max., I _D : –2.4 A max., V _{th} : –1 V min., C _{iss} : 470 pF typ., R _{on} : 0.15 Ω max. (V _{GS} = –4.5 V), Micro 8 package				

1. Efficiency Characteristics: Output current (I_{OUT})-Efficiency (EFFI)

(1) S-8520B30MC



(2) S-8520F33MC

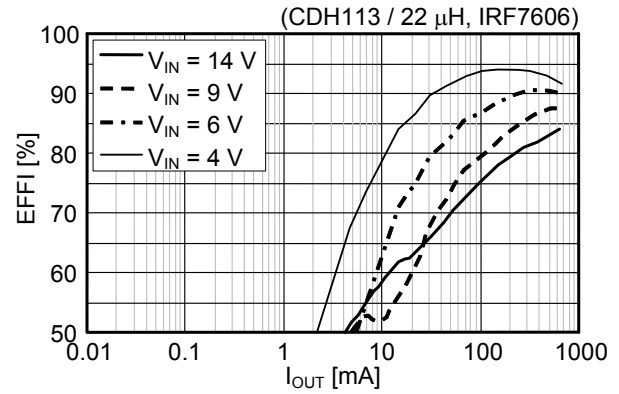

(3) S-8521D30MC

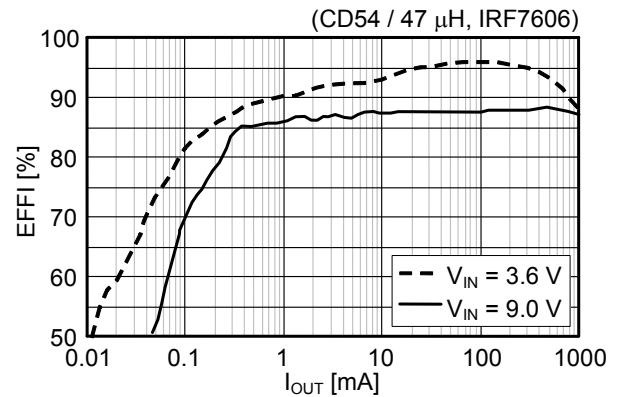

(4) S-8521B30MC

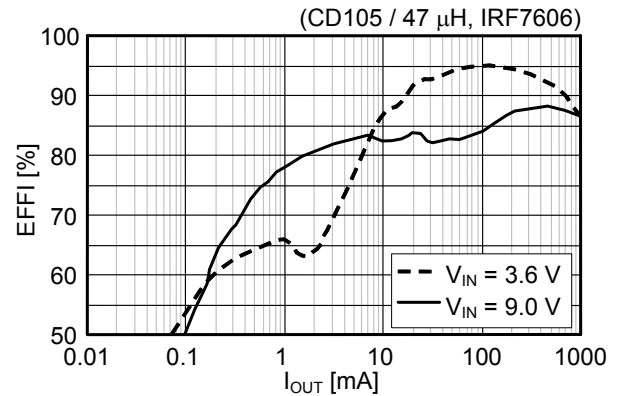

(5) S-8521F33MC



(6) S-8520B50MC

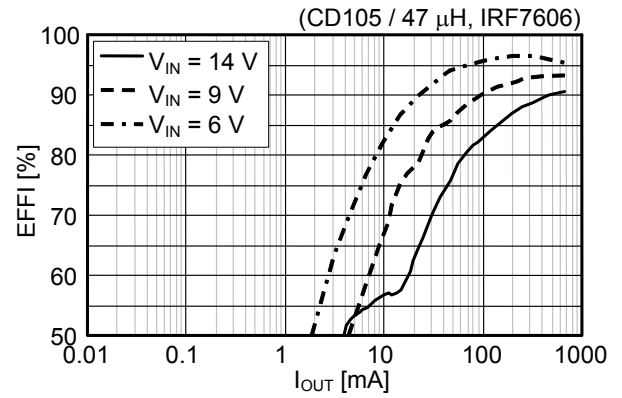
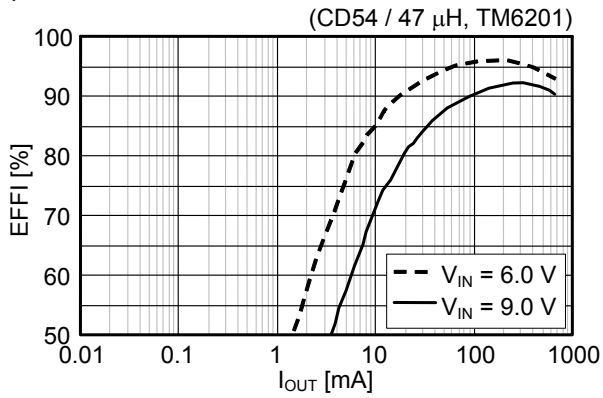

(7) S-8520F50MC

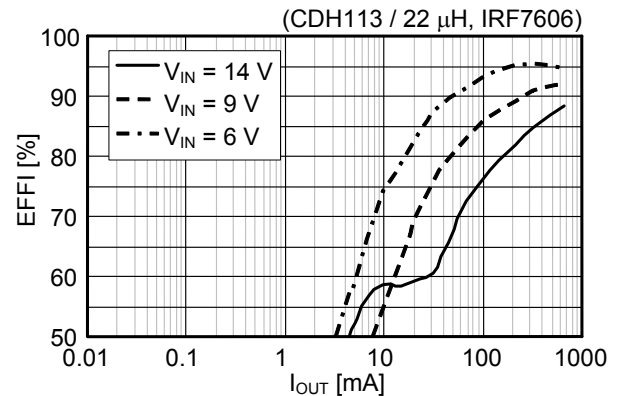

(8) S-8521D50MC

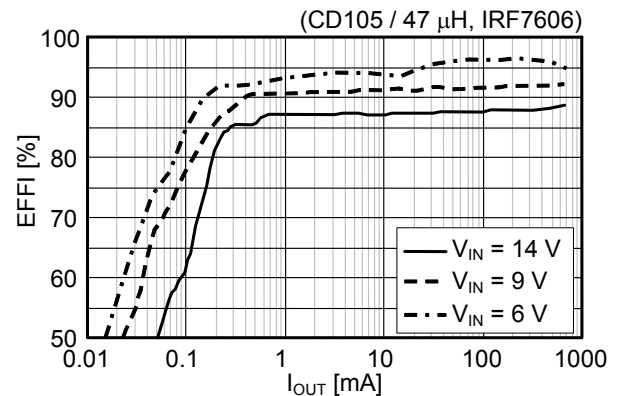

(9) S-8521B50MC

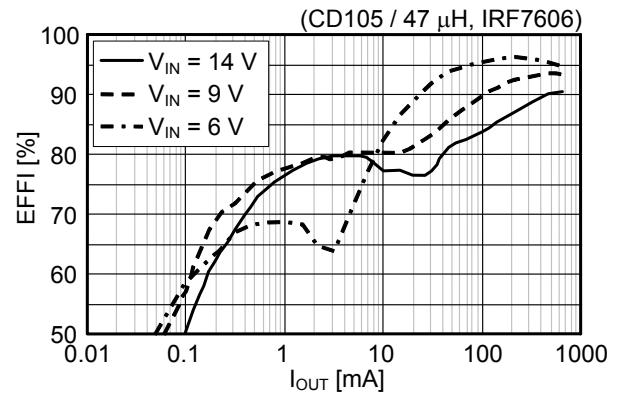

(10) S-8521F50MC

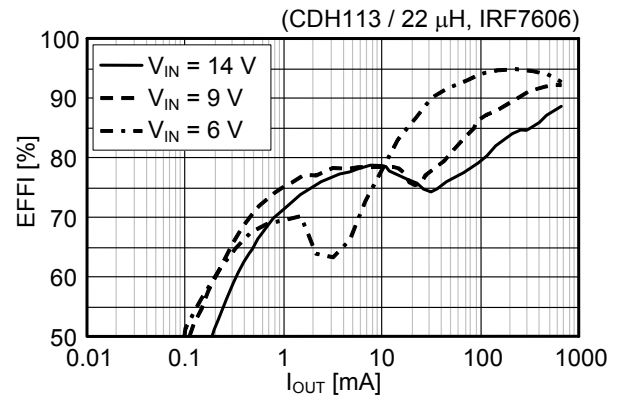
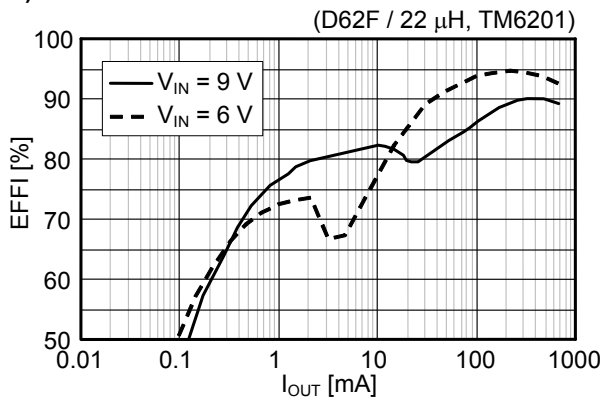

2. Ripple Voltage Characteristics: Ripple voltage (V_{rip})-Input voltage (V_{IN}) (L: CD105 / 47 μ H, Tr: 2SA1213, SBD: MA720)

(1) S-8520D30MC

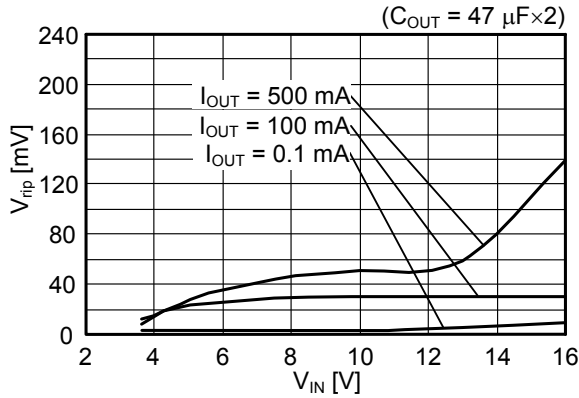

(2) S-8521D30MC



(3) S-8520B30MC

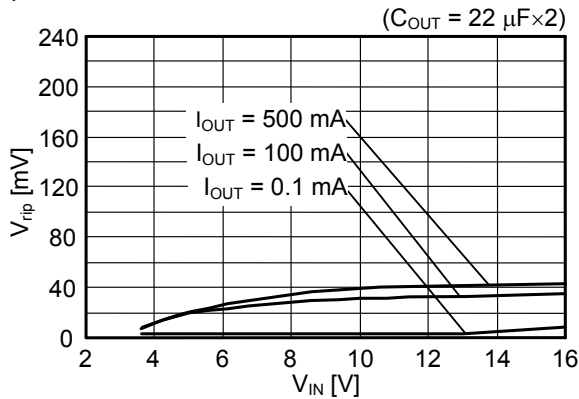

(4) S-8521B30MC



(5) S-8520F33MC

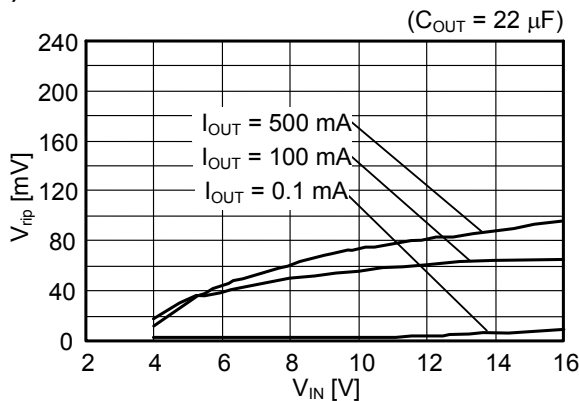

(6) S-8521F33MC



(7) S-8520D50MC

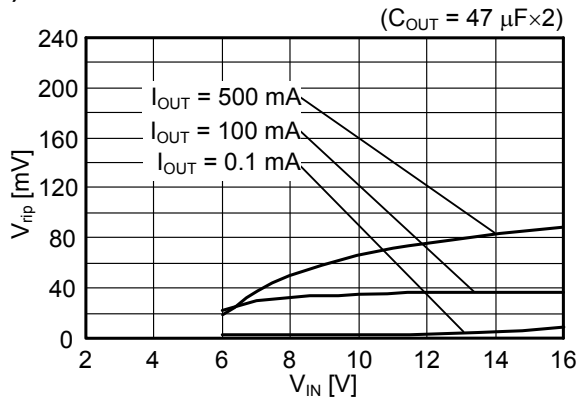

(8) S-8521D50MC

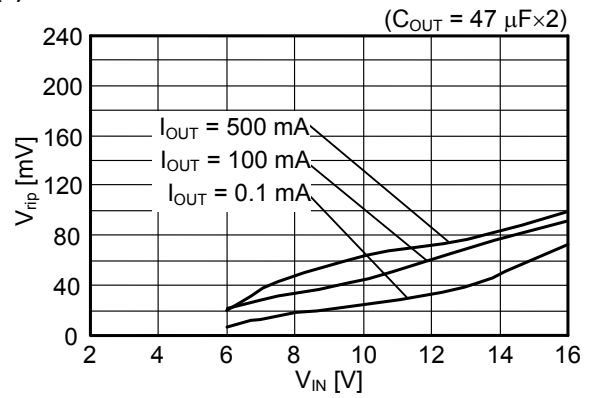

(9) S-8520B50MC



(10) S-8521B50MC



(11) S-8520F50MC



(12) S-8521F50MC

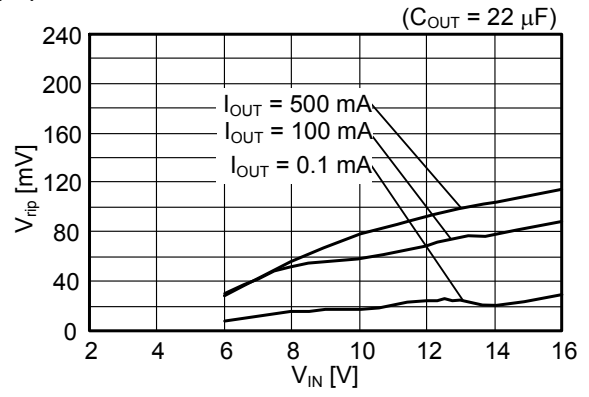

3. PWM / PFM switching characteristics: Input voltage (V_{IN})-Output current (I_{OUT})

(1) S-8521D30MC



(2) S-8521B30MC



(3) S-8521F33MC



(4) S-8521D50MC

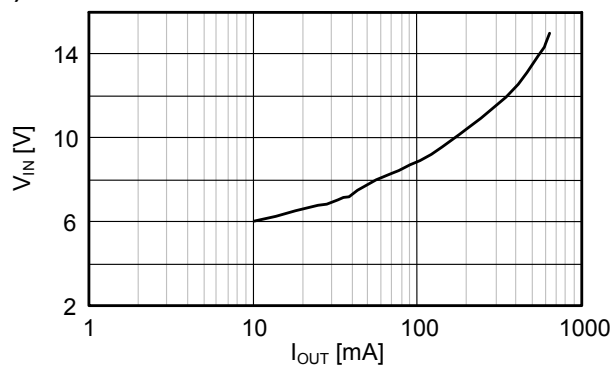

(5) S-8521B50MC



(6) S-8521F50MC





No. MP005-A-P-SD-1.3

TITLE	SOT235-A-PKG Dimensions
No.	MP005-A-P-SD-1.3
ANGLE	
UNIT	mm
ABLIC Inc.	



→ Feed direction

No. MP005-A-C-SD-2.1

TITLE	SOT235-A-Carrier Tape
No.	MP005-A-C-SD-2.1
ANGLE	
UNIT	mm

ABLIC Inc.



Enlarged drawing in the central part



No. MP005-A-R-SD-1.1

TITLE	SOT235-A-Reel		
No.	MP005-A-R-SD-1.1		
ANGLE		QTY.	3,000
UNIT	mm		
ABLIC Inc.			

Disclaimers (Handling Precautions)

1. All the information described herein (product data, specifications, figures, tables, programs, algorithms and application circuit examples, etc.) is current as of publishing date of this document and is subject to change without notice.
2. The circuit examples and the usages described herein are for reference only, and do not guarantee the success of any specific mass-production design.
ABLIC Inc. is not liable for any losses, damages, claims or demands caused by the reasons other than the products described herein (hereinafter "the products") or infringement of third-party intellectual property right and any other right due to the use of the information described herein.
3. ABLIC Inc. is not liable for any losses, damages, claims or demands caused by the incorrect information described herein.
4. Be careful to use the products within their ranges described herein. Pay special attention for use to the absolute maximum ratings, operation voltage range and electrical characteristics, etc.
ABLIC Inc. is not liable for any losses, damages, claims or demands caused by failures and / or accidents, etc. due to the use of the products outside their specified ranges.
5. Before using the products, confirm their applications, and the laws and regulations of the region or country where they are used and verify suitability, safety and other factors for the intended use.
6. When exporting the products, comply with the Foreign Exchange and Foreign Trade Act and all other export-related laws, and follow the required procedures.
7. The products are strictly prohibited from using, providing or exporting for the purposes of the development of weapons of mass destruction or military use. ABLIC Inc. is not liable for any losses, damages, claims or demands caused by any provision or export to the person or entity who intends to develop, manufacture, use or store nuclear, biological or chemical weapons or missiles, or use any other military purposes.
8. The products are not designed to be used as part of any device or equipment that may affect the human body, human life, or assets (such as medical equipment, disaster prevention systems, security systems, combustion control systems, infrastructure control systems, vehicle equipment, traffic systems, in-vehicle equipment, aviation equipment, aerospace equipment, and nuclear-related equipment), excluding when specified for in-vehicle use or other uses by ABLIC, Inc. Do not apply the products to the above listed devices and equipments.
ABLIC Inc. is not liable for any losses, damages, claims or demands caused by unauthorized or unspecified use of the products.
9. In general, semiconductor products may fail or malfunction with some probability. The user of the products should therefore take responsibility to give thorough consideration to safety design including redundancy, fire spread prevention measures, and malfunction prevention to prevent accidents causing injury or death, fires and social damage, etc. that may ensue from the products' failure or malfunction.
The entire system in which the products are used must be sufficiently evaluated and judged whether the products are allowed to apply for the system on customer's own responsibility.
10. The products are not designed to be radiation-proof. The necessary radiation measures should be taken in the product design by the customer depending on the intended use.
11. The products do not affect human health under normal use. However, they contain chemical substances and heavy metals and should therefore not be put in the mouth. The fracture surfaces of wafers and chips may be sharp. Be careful when handling these with the bare hands to prevent injuries, etc.
12. When disposing of the products, comply with the laws and ordinances of the country or region where they are used.
13. The information described herein contains copyright information and know-how of ABLIC Inc. The information described herein does not convey any license under any intellectual property rights or any other rights belonging to ABLIC Inc. or a third party. Reproduction or copying of the information from this document or any part of this document described herein for the purpose of disclosing it to a third-party is strictly prohibited without the express permission of ABLIC Inc.
14. For more details on the information described herein or any other questions, please contact ABLIC Inc.'s sales representative.
15. This Disclaimers have been delivered in a text using the Japanese language, which text, despite any translations into the English language and the Chinese language, shall be controlling.

2.4-2019.07

Mouser Electronics

Authorized Distributor

Click to View Pricing, Inventory, Delivery & Lifecycle Information:

ABLIC:

[S-8520D28MC-BVNT2G](#) [S-8520A28MC-AVNT2G](#) [S-8520C28MC-BRNT2G](#) [S-8521D28MC-BXNT2G](#) [S-8521B28MC-ATNT2G](#) [S-8521C28MC-BTNT2G](#) [S-8521A28MC-AXNT2G](#) [S-8520D36MC-BVVT2G](#) [S-8520B36MC-ARVT2G](#) [S-8520C36MC-BRVT2G](#) [S-8520A36MC-AVVT2G](#) [S-8521B36MC-ATVT2G](#) [S-8521D36MC-BXVT2G](#) [S-8521A36MC-AXVT2G](#) [S-8521C36MC-BTVT2G](#) [S-8521B19MC-ATET2G](#) [S-8520C31MC-BRQT2G](#) [S-8520A31MC-AVQT2G](#) [S-8520B31MC-ARQT2G](#) [S-8520D31MC-BVQT2G](#) [S-8521A31MC-AXQT2G](#) [S-8521C31MC-BTQT2G](#) [S-8521D31MC-BXQT2G](#) [S-8521B31MC-ATQT2G](#) [S-8521F50MC-BQJT2G](#) [S-8521B50MC-AUJT2G](#) [S-8521D50MC-BYJT2G](#) [S-8521E50MC-BMJT2G](#) [S-8521A50MC-AYJT2G](#) [S-8521C50MC-BUJT2G](#) [S-8520D50MC-BWJT2G](#) [S-8520F50MC-BOJT2G](#) [S-8520B50MC-ASJT2G](#) [S-8520C50MC-BSJT2G](#) [S-8520E50MC-BKJT2G](#) [S-8520A50MC-AWJT2G](#) [S-8520B30MC-ARPT2G](#) [S-8520F30MC-BNPT2G](#) [S-8520D30MC-BVPT2G](#) [S-8520A30MC-AVPT2G](#) [S-8520E30MC-BJPT2G](#) [S-8520C30MC-BRPT2G](#) [S-8521D30MC-BXPT2G](#) [S-8521F30MC-BPPT2G](#) [S-8521B30MC-ATPT2G](#) [S-8521C30MC-BTPT2G](#) [S-8521E30MC-BLPT2G](#) [S-8521A30MC-AXPT2G](#) [S-8521D16MC-BXBT2G](#) [S-8520E33MC-BJST2G](#) [S-8520A33MC-AVST2G](#) [S-8520C33MC-BRST2G](#) [S-8520D33MC-BVST2G](#) [S-8520B33MC-ARST2G](#) [S-8520F33MC-BNST2G](#) [S-8521D33MC-BXST2G](#) [S-8521B33MC-ATST2G](#) [S-8521F33MC-BPST2G](#) [S-8521C33MC-BTST2G](#) [S-8521A33MC-AXST2G](#) [S-8521E33MC-BLST2G](#) [S-8521D25MC-BXKT2G](#) [S-8521B25MC-ATKT2G](#) [S-8521C25MC-BTKT2G](#) [S-8521A25MC-AXKT2G](#) [S-8520B25MC-ARKT2G](#) [S-8520F25MC-BNKT2G](#) [S-8520D25MC-BVKT2G](#) [S-8520A25MC-AVKT2G](#) [S-8520C25MC-BRKT2G](#) [S-8521D34MC-BXTT2G](#) [S-8521B34MC-ATTT2G](#) [S-8521C34MC-BTTT2G](#) [S-8521A34MC-AXTT2G](#) [S-8520F34MC-BNTT2G](#) [S-8520B34MC-ARTT2G](#) [S-8520D34MC-BVTT2G](#) [S-8520A34MC-AVTT2G](#) [S-8520C34MC-BRTT2G](#) [S-8521E20MC-BLFT2G](#) [S-8521B20MC-ATFT2G](#) [S-8521D20MC-BXFT2G](#) [S-8520E20MC-BJKT2G](#) [S-8521A29MC-AXOT2G](#) [S-8521C29MC-BTOT2G](#) [S-8521D29MC-BXOT2G](#) [S-8521B29MC-ATOT2G](#) [S-8520C29MC-BROT2G](#) [S-8520A29MC-AVOT2G](#) [S-8520B29MC-AROT2G](#) [S-8520D29MC-BVOT2G](#) [S-8521E15MC-BLAT2G](#) [S-8521B32MC-ARTT2G](#) [S-8521D32MC-BXRT2G](#) [S-8521A32MC-AXRT2G](#) [S-8521C32MC-BTRT2G](#) [S-8520D32MC-BVRT2G](#) [S-8520B32MC-ARRT2G](#) [S-8520C32MC-BRRT2G](#) [S-8520A32MC-AVRT2G](#)



Компания «ЭлектроПласт» предлагает заключение долгосрочных отношений при поставках импортных электронных компонентов на взаимовыгодных условиях!

Наши преимущества:

- Оперативные поставки широкого спектра электронных компонентов отечественного и импортного производства напрямую от производителей и с крупнейших мировых складов;
- Поставка более 17-ти миллионов наименований электронных компонентов;
- Поставка сложных, дефицитных, либо снятых с производства позиций;
- Оперативные сроки поставки под заказ (от 5 рабочих дней);
- Экспресс доставка в любую точку России;
- Техническая поддержка проекта, помощь в подборе аналогов, поставка прототипов;
- Система менеджмента качества сертифицирована по Международному стандарту ISO 9001;
- Лицензия ФСБ на осуществление работ с использованием сведений, составляющих государственную тайну;
- Поставка специализированных компонентов (Xilinx, Altera, Analog Devices, Intersil, Interpoint, Microsemi, Aeroflex, Peregrine, Syfer, Eurofarad, Texas Instrument, Miteq, Cobham, E2V, MA-COM, Hittite, Mini-Circuits, General Dynamics и др.);

Помимо этого, одним из направлений компании «ЭлектроПласт» является направление «Источники питания». Мы предлагаем Вам помощь Конструкторского отдела:

- Подбор оптимального решения, техническое обоснование при выборе компонента;
- Подбор аналогов;
- Консультации по применению компонента;
- Поставка образцов и прототипов;
- Техническая поддержка проекта;
- Защита от снятия компонента с производства.



Как с нами связаться

Телефон: 8 (812) 309 58 32 (многоканальный)

Факс: 8 (812) 320-02-42

Электронная почта: org@eplast1.ru

Адрес: 198099, г. Санкт-Петербург, ул. Калинина, дом 2, корпус 4, литера А.