

For Direct Marking Applications

OMRON

Handheld 2D Code Reader V400-H Series

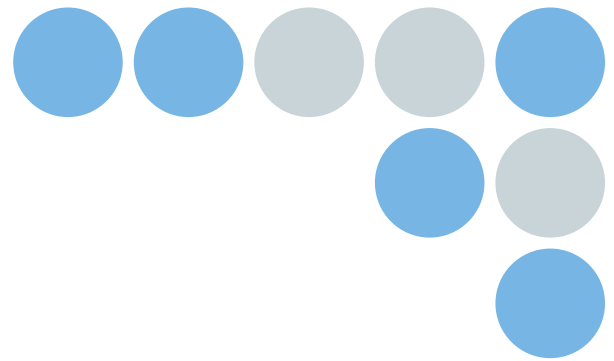

realizing

A New Handy Reader Capable

The increasing importance that is being placed on productivity improvements and data management in recent years has led to a rise in the need to mark information directly onto products. The information extends from general product and production information to a production history that tells exactly how the product was manufactured.

Data management in which space-efficient 2D codes are directly stamped onto products is making particularly rapid progress. For a variety of reasons, however, such as the fact that the surface on which the 2D codes are stamped lacks smoothness, conventional handheld readers have difficulty reading them with sufficient stability.

The V400-H Series was developed from the concept of creating a handheld reader that is capable of reading directly marked codes. It accurately reads 2D codes directly marked onto metallic or LCD panels, printed circuit boards, and other objects.



of Reading Directly Marked Codes

Stable Reading from a Wide Variety of Objects Patent pending

One of the industry's most advanced reading algorithms combines with an optical system that is highly suited to direct marking applications, to deliver highly accurate reading capabilities. The Reader is also equipped with its own coaxial illumination and oblique illumination. The illumination is automatically switched to match the object being read, enabling superior reading of 2D codes marked onto materials with different reflection factors.

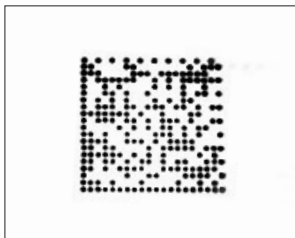

Metal (treated surface)

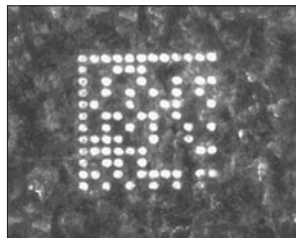

Metal (casting surface)



Glass wafer



Printed circuit board

Bringing Greater Visibility to 2D Code Reading

- The LCD monitor lets you confirm the position of the 2D code, then displays the reading results and image.
- Using the detachable Contactor greatly simplifies positioning.



Designed for Easy Use on Production Lines

Read Data Is Stored onto an SD Memory Card

The 2D code data read by the Code Reader can be stored onto an SD Memory Card together with a time stamp.



Easy-to-press Trigger Buttons

The trigger buttons are positioned where the thumb is naturally placed when holding the Code Reader's grip.

Settings Can Be Changed On-site

Changes can be made to the settings without having to use a personal computer.

Easy-to-hold Grip Shape

Grooves along the bottom surface of the grip ensure a good fit even when wearing gloves.

Two Hanging Hooks

Hanging hooks on both upper and lower parts of the Code Reader allow it to be easily hung somewhere near the production line.

Safe Protective Structure

An IP64 enclosure rating prevents adverse effects from water splashing on the line.

Easy-to-see Contactor

The transparent material used in the Contactor improves visibility.

Target Object Protective Cover

A rubber protector on the surface that contacts the object prevents scratches.

Two Cable Lengths Available:
2 Meters and 5 Meters

AC Adaptor Also Available

Select either a 5-VDC Power Supply or an AC Adaptor to match the conditions of use.
(Each uses a different cable model.)



Variable Field of Vision

The zoom lever lets you easily change the field of vision to match the size of the code being read.

Narrow Field of Vision Model (V400-H111)

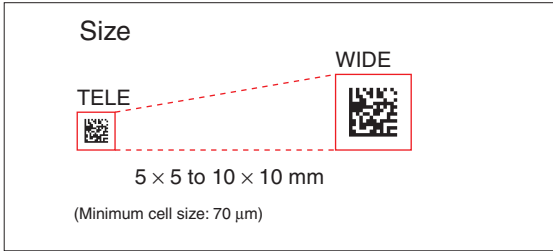

Wide Field of Vision Model (V400-H211)

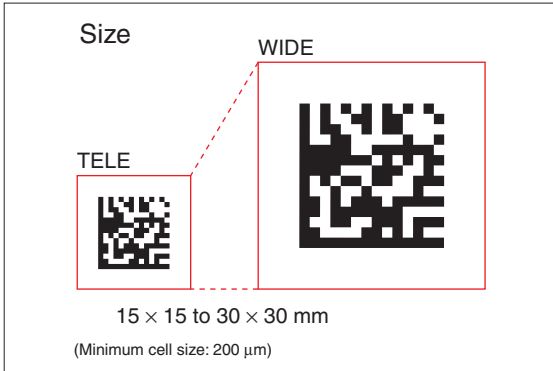

Display Customizing Function Patent pending

The 2D code data that is read can be displayed on the LCD as a previously registered text string.*

* Special software is available for set-up. See the operation manual for details.



Sample display with the function OFF

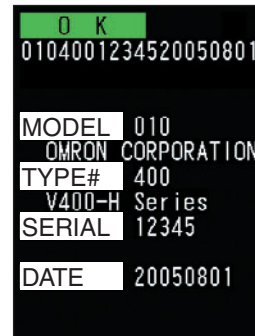

Sample display with the function ON

Versatile LCD Display Patterns

The reading results can be displayed in four patterns to match your application.



Examples of Typical Applications

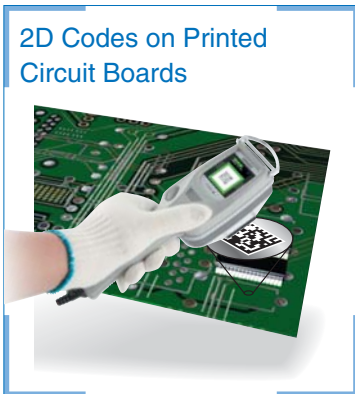
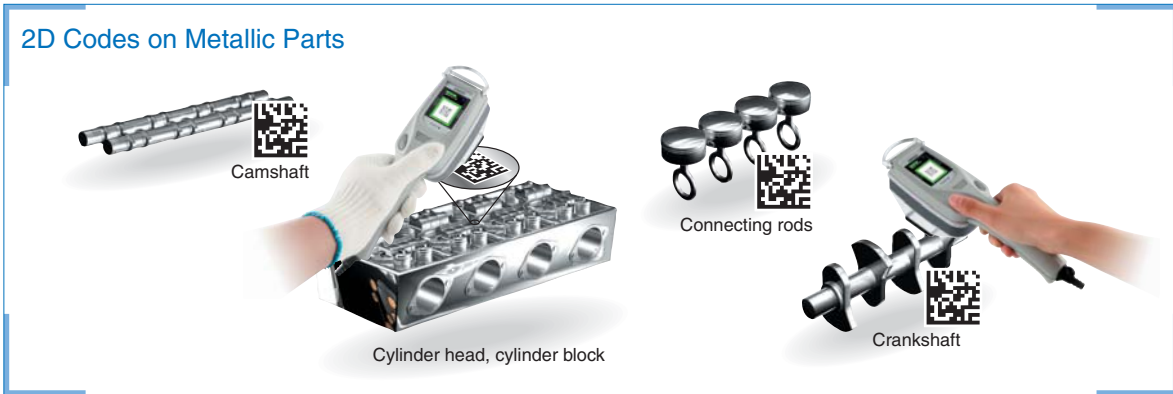

System Configuration

The Code Reader can be connected with other equipment via RS232C.

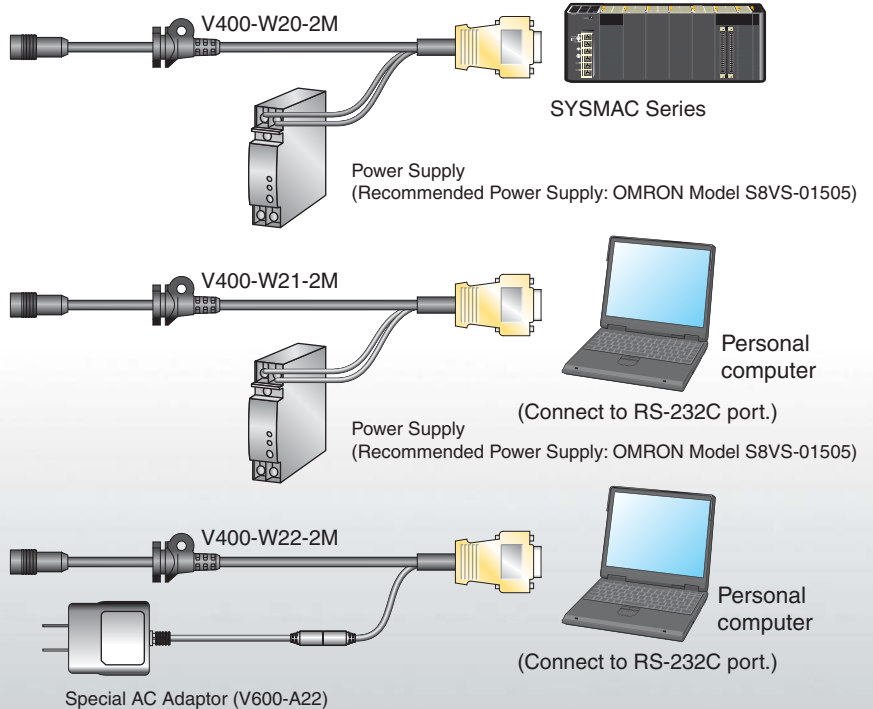

Ordering Information

Main Unit

Name	Model	Specifications		Remarks
		Communications interface	Field of vision	
2D Code Reader 	V400-H111	RS-232C	5 × 5 to 10 × 10 mm	
	V400-H211	RS-232C	15 × 15 to 30 × 30 mm	

Accessories (Purchase separately)

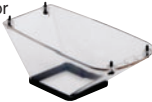
Name	Model	Cable length	Remarks
Contactor 	V400-AC2	---	Contactor for positioning (detachable)
Communications Cable	V400-W20-2M	2 m	For SYSMAC Series connection (with power cord)
	V400-W20-5M	5 m	
	V400-W21-2M	2 m	For PC-compatible connection (with power cord)
	V400-W21-5M	5 m	
	V400-W22-2M	2 m	For PC-compatible connection (when using AC Adaptor)
	V400-W22-5M	5 m	
AC Adaptor	V600-A22	---	

Ratings and Specifications

Item	V400-H111	V400-H211
Field of vision	5 × 5 to 10 × 10 mm	15 × 15 to 30 × 30 mm
Cell size	0.08 to 0.2 mm	0.2 to 0.65 mm
Code size	0.8 × 0.8 to 5 × 5 mm	2.0 × 2.0 to 15 × 15 mm
Working distance	40 mm (flush when Contactor is mounted)	
Power supply	5 VDC ±10%	
Current consumption	1.0 A max.	
Serial interface	RS-232C	
Applicable codes	Data Matrix, ECC200, 10 × 10 to 64 × 64, 8 × 18 to 16 × 48, QR Code (Models 1, 2), 21 × 21 to 57 × 57 (Versions 1 to 10)	
Operation method	Pressing the trigger button	
Settings	Make settings by using the manual setting window, uploading from an SD Memory Card, or by using Support Software.	
Memory card	SD Memory Card	
Monitor	1.8-inch TFT LCD, displaying images and read data	
Display illumination	Operation display, memory card access	
Ambient temperature	Operation: 0 to 40°C; storage: -25 to 60°C	
Ambient humidity	35 to 85% (with no condensation)	
Ambient conditions	No corrosive gases	
Vibration resistance	10 to 150 Hz, single amplitude 0.35 mm (50 m ² /s max. acceleration)	
Shock resistance	150 m ² /s in ±X, Y, and Z directions, 3 times	
Weight	Approx. 230 g	
Degree of protection	IEC 60529 IP64	
Materials	Case: ABS; optical surface: PC; display surface: PMMA	

Dimensions (Unit: mm)

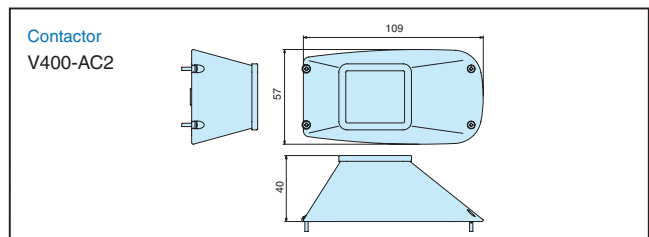
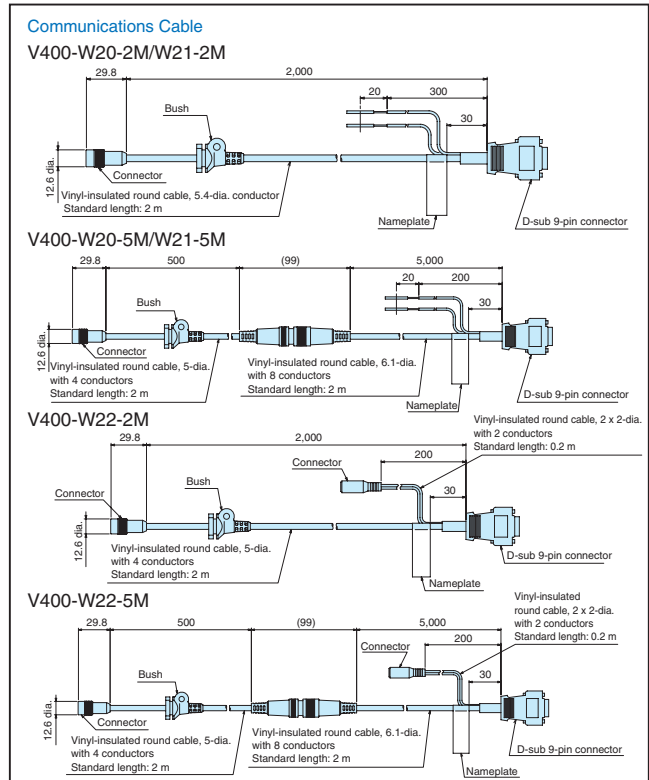
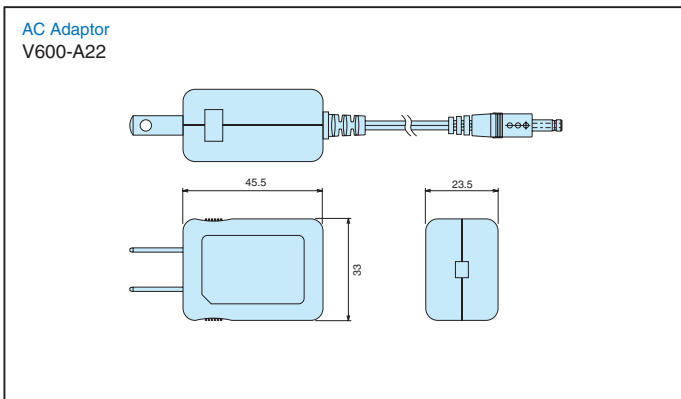
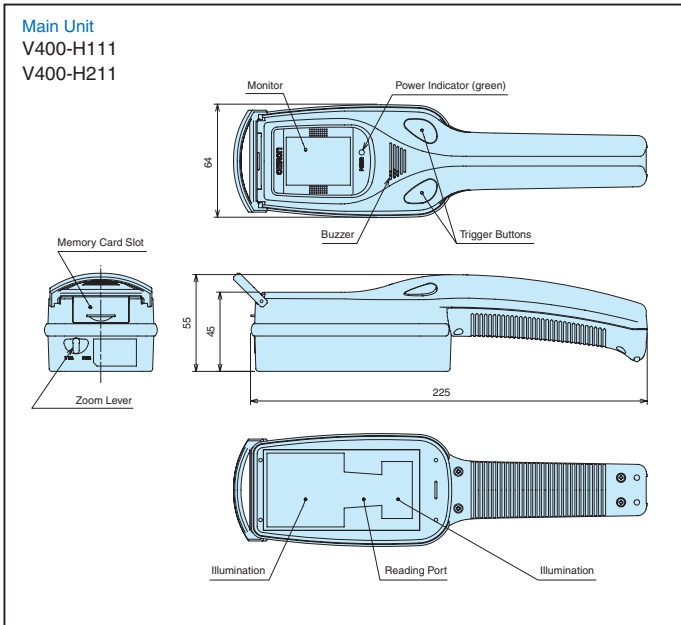

This document provides information mainly for selecting suitable models. Please refer to the User's Manual (Cat. No. Z228) for information that the user must understand and accept before purchase, including information on warranty, limitations of liability, and precautions.

OMRON Corporation Industrial Automation Company
Tokyo, JAPAN

Contact: www.ia.omron.com

Regional Headquarters
OMRON EUROPE B.V.
Sensor Business Unit
Carl-Benz-Str. 4, D-71154 Nufringen, Germany
Tel: (49) 7032-811-0/Fax: (49) 7032-811-199

OMRON ELECTRONICS LLC
One Commerce Drive Schaumburg,
IL 60173-5302 U.S.A.
Tel: (1) 847-843-7900/Fax: (1) 847-843-7787

OMRON ASIA PACIFIC PTE. LTD.
No. 438A Alexandra Road # 05-05/08 (Lobby 2),
Alexandra Technopark,
Singapore 119967
Tel: (65) 6835-3011/Fax: (65) 6835-2711

OMRON (CHINA) CO., LTD.
Room 2211, Bank of China Tower,
200 Yin Cheng Zhong Road,
PuDong New Area, Shanghai, 200120, China
Tel: (86) 21-5037-2222/Fax: (86) 21-5037-2200

Authorized Distributor:

© OMRON Corporation 2009 All Rights Reserved.
In the interest of product improvement,
specifications are subject to change without notice.

CSM_1_3_1209
Cat. No. Q146-E1

Printed in Japan



Компания «ЭлектроПласт» предлагает заключение долгосрочных отношений при поставках импортных электронных компонентов на взаимовыгодных условиях!

Наши преимущества:

- Оперативные поставки широкого спектра электронных компонентов отечественного и импортного производства напрямую от производителей и с крупнейших мировых складов;
- Поставка более 17-ти миллионов наименований электронных компонентов;
- Поставка сложных, дефицитных, либо снятых с производства позиций;
- Оперативные сроки поставки под заказ (от 5 рабочих дней);
- Экспресс доставка в любую точку России;
- Техническая поддержка проекта, помощь в подборе аналогов, поставка прототипов;
- Система менеджмента качества сертифицирована по Международному стандарту ISO 9001;
- Лицензия ФСБ на осуществление работ с использованием сведений, составляющих государственную тайну;
- Поставка специализированных компонентов (Xilinx, Altera, Analog Devices, Intersil, Interpoint, Microsemi, Aeroflex, Peregrine, Syfer, Eurofarad, Texas Instrument, Miteq, Cobham, E2V, MA-COM, Hittite, Mini-Circuits, General Dynamics и др.);

Помимо этого, одним из направлений компании «ЭлектроПласт» является направление «Источники питания». Мы предлагаем Вам помощь Конструкторского отдела:

- Подбор оптимального решения, техническое обоснование при выборе компонента;
- Подбор аналогов;
- Консультации по применению компонента;
- Поставка образцов и прототипов;
- Техническая поддержка проекта;
- Защита от снятия компонента с производства.



Как с нами связаться

Телефон: 8 (812) 309 58 32 (многоканальный)

Факс: 8 (812) 320-02-42

Электронная почта: org@eplast1.ru

Адрес: 198099, г. Санкт-Петербург, ул. Калинина, дом 2, корпус 4, литера А.