

## SERIES 34A

### Miniature Toggle Switches

#### FEATURES

- Save Space and Weight
- SPDT, DPDT, 3PDT, and 4DPT Circuitry
- Choice of Actuators, Bushings and Terminations
- UL Recognized



#### MODELS In inches (and millimeters)

##### SPDT

MODEL NO.	SWITCH POSITION		
SP1	ON	NONE	ON
SP2	ON	NONE	(ON)
SP3	ON	OFF	ON
SP4	(ON)	OFF	(ON)
SP5	ON	OFF	(ON)
TERM. COMM.	2-3	OPEN	2-1

( )=MOMENTARY

02COMM.

SCHEMATIC

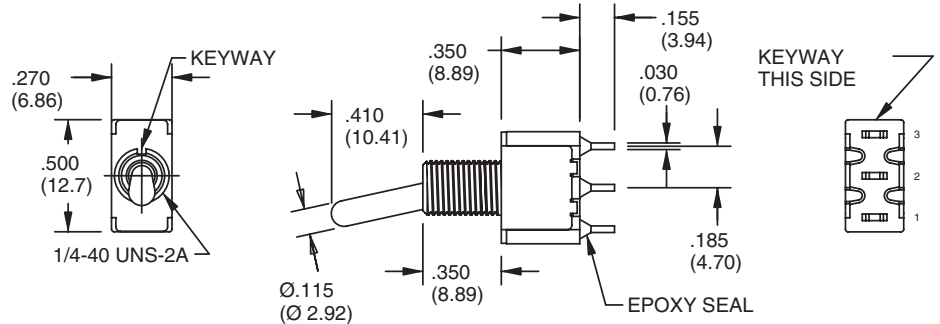

##### DPDT

MODEL NO.	SWITCH POSITION		
DP1	ON	NONE	ON
DP2	ON	NONE	(ON)
DP3	ON	OFF	ON
DP4	(ON)	OFF	(ON)
DP5	ON	OFF	(ON)
TERM. COMM.	2-3, 5-6	OPEN	2-1, 5-4

( )=MOMENTARY

02COMM.

05COMM.

SCHEMATIC

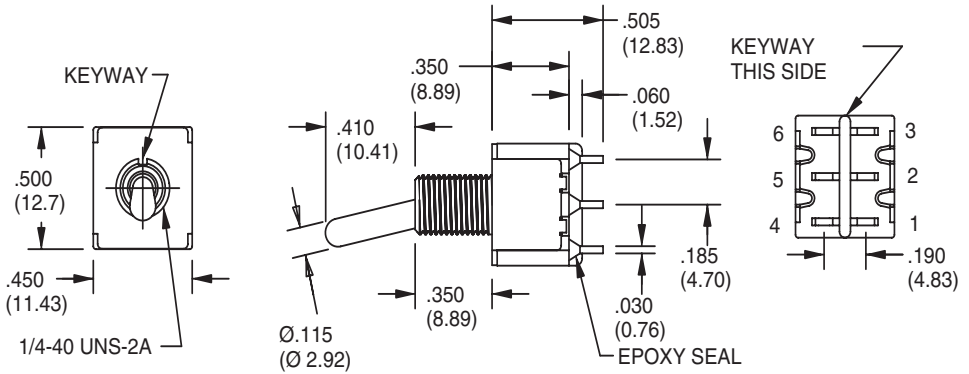
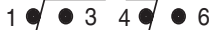

##### 3PDT

MODEL NO.	SWITCH POSITION		
3P1	ON	NONE	ON
3P2	ON	NONE	(ON)
3P3	ON	OFF	ON
3P4	(ON)	OFF	(ON)
3P5	ON	OFF	(ON)
TERM. COMM.	2-3,5-6, 8-9	OPEN	2-1,5-4, 8-7

( )=MOMENTARY

02COMM.

05COMM.

08COMM.



SCHEMATIC

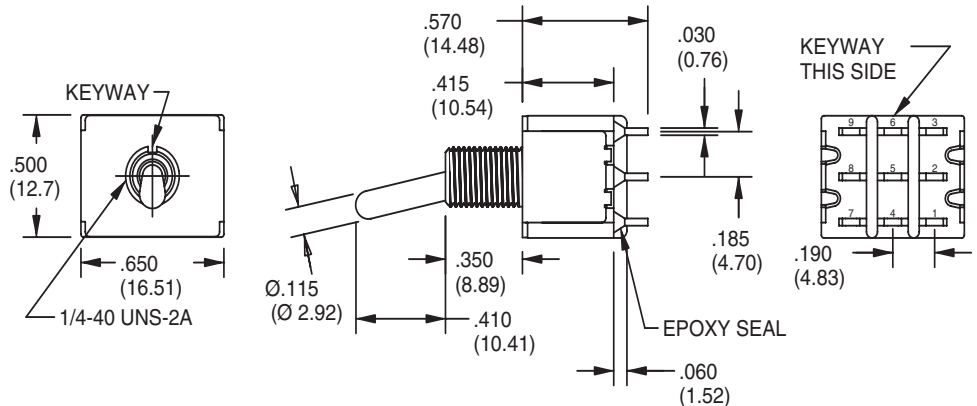

**MODELS** In inches (and millimeters)

**4PDT**

MODEL NO.	SWITCH POSITION		
	ON	NONE	ON
4P1	ON	NONE	ON
4P2	ON	NONE	(ON)
4P3	ON	OFF	ON
4P4	(ON)	OFF	(ON)
4P5	ON	OFF	(ON)
TERM. COMM.	2-3,5-6 8-9,11-12	OPEN	2-1,5-4 8-7,11-10

( )=MOMENTARY

SCALE:1.5:1

KEYWAY THIS SIDE

EPOXY SEAL

02COMM. 05COMM. 08COMM. 011COMM.

1 3 4 6 7 9 10 12

SCHEMATIC

**ACTUATOR OPTIONS** In inches (and millimeters)

<p><b>1</b> Std</p>	<p><b>2</b></p>	<p><b>3</b></p>	<p><b>4</b></p>	<p><b>5</b></p>
<p><b>6</b></p> <p>Use with Bushing Options T1, T2, T5 and T6 only.</p>	<p><b>7</b></p> <p>Use T7 Bushing Option only.</p>	<p><b>8</b></p> <p>Use T7 Bushing Option only.</p>	<p><b>9</b> Nylon Black</p>	<p><b>L</b> THD. (STD.) <b>N</b> NON-THD</p>

Actuators 1-5 shown with standard B1 bushing. Add .070 (1.78) for B3, subtract .020 (0.51) for B6 bushing.

### BUSHING OPTIONS In inches (and millimeters)

<p><b>B1 Thd (Std)</b> <b>B2 Non-Thd</b></p>	<p><b>B3 Thd</b> <b>B4 Non-Thd</b></p>	<p><b>B5 High Torque</b></p>	<p><b>B6 High Torque</b></p>	
<p><b>B7 Long</b></p>	<p><b>B8 Metric</b></p>	<p><b>B9 Splash-Proof</b></p>		
<p><b>T1</b></p>	<p><b>T2</b></p>	<p><b>T5</b></p>	<p><b>T6</b></p>	<p><b>T7</b></p>

Toggle Switches

### PANEL MOUNTING In inches (and millimeters)

<p><b>1/4" BUSHING</b></p>			
<p><b>15/32" BUSHING</b></p>			
<p><b>METRIC BUSHING</b></p>			

TERMINATION OPTIONS In inches (and millimeters)

<p><b>M1 Solder Lug (Std)</b></p> <p>THK. .030 (0.76)</p>	<p><b>M2 P.C. Mount</b></p> <p>THK. .030 (0.76)</p>	<p><b>M3 P.C. Mount, Quick Connect</b></p> <p>.030 (0.76) THK.</p>	<p><b>WX</b></p> <table border="1"> <thead> <tr> <th>OPTION CODE</th> <th>DIM. "A"</th> </tr> </thead> <tbody> <tr> <td>W1</td> <td>.750 (19.05)</td> </tr> <tr> <td>W2</td> <td>.964 (24.46)</td> </tr> <tr> <td>W3</td> <td>.425 (10.80)</td> </tr> <tr> <td>W4</td> <td>1.062 (26.97)</td> </tr> </tbody> </table> <p>WIRE WRAP</p>	OPTION CODE	DIM. "A"	W1	.750 (19.05)	W2	.964 (24.46)	W3	.425 (10.80)	W4	1.062 (26.97)
OPTION CODE	DIM. "A"												
W1	.750 (19.05)												
W2	.964 (24.46)												
W3	.425 (10.80)												
W4	1.062 (26.97)												
<p><b>M6 Right Angle P.C. Mount, Horizontal Actuation</b></p> <p>SPDT</p> <p>DPDT</p> <p>KEYWAY THIS SIDE</p> <p>P.C. MOUNTING</p>													
<p><b>M7 Right Angle P.C. Mount, Vertical Actuation</b></p> <p>SPDT</p> <p>DPDT</p> <p>KEYWAY THIS SIDE</p> <p>P.C. MOUNTING</p>													

TERMINATION OPTIONS In inches (and millimeters)

M7 Right Angle P.C. Mount, Vertical Actuation



V2-V3 Vertical Bracket P.C. Mount



Toggle Switches

## SPECIFICATIONS RATINGS

Contact Rating: Q option - 5A with resistive load @ 125VAC or 28 VDC; 2A with resistive load @ 250 VAC. R option-0.4 VA max @ 20 Vmax (AC or DC)  
 Electrical Life: 40,000 make-and-break cycles at full load

Contact Resistance: 10 milliohms max. initial @ 2-4 VDC, 100 mA for both gold & silver contacts  
 Insulation Resistance: 1,000 megaohms minimum  
 Dielectric Strength: 1,000 V RMS @ sea level  
 Operating Temperature: -30°C to 85°C  
 UL Recognition: File number is E35289

## MATERIALS

Case: Diallyl phthalate (DAP) (UL94V-0)  
 Toggle Handle: Brass, chrome-plated  
 Bushing: Brass, nickle-plated  
 Housing: Stainless steel

## ORDERING INFORMATION



Available from your local Grayhill Component Distributor. For prices and discounts, contact a local Sales Office, an authorized local Distributor or Grayhill.

## HARDWARE In inches (and millimeters)

### NUTS

Series 34A (Std)

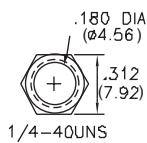

HDW2

Dress Nut

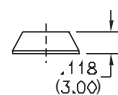
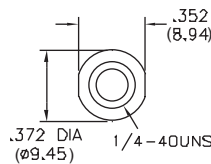

HDW3

For Actuator Options 7, 8 (Std)

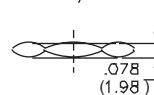
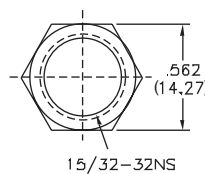

HDW4

Knurled Nut (Sealed)

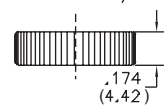
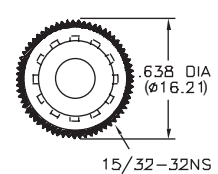

HDW5

### LOCKING RINGS

Series 34A (Std)

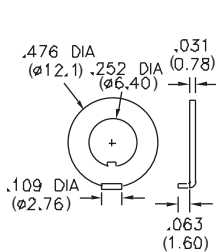

HDW15

For Actuator Options 7, 8

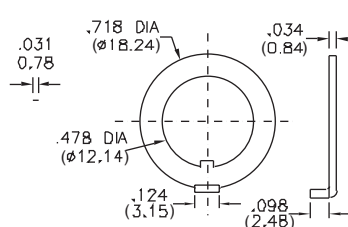

HDW17

### LOCK WASHERS

Series 34A (Std)

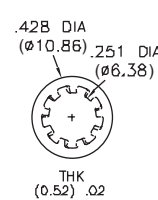

HDW11

For Actuator Options 7, 8

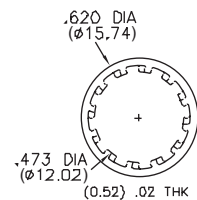

HDW12



Компания «ЭлектроПласт» предлагает заключение долгосрочных отношений при поставках импортных электронных компонентов на взаимовыгодных условиях!

Наши преимущества:

- Оперативные поставки широкого спектра электронных компонентов отечественного и импортного производства напрямую от производителей и с крупнейших мировых складов;
- Поставка более 17-ти миллионов наименований электронных компонентов;
- Поставка сложных, дефицитных, либо снятых с производства позиций;
- Оперативные сроки поставки под заказ (от 5 рабочих дней);
- Экспресс доставка в любую точку России;
- Техническая поддержка проекта, помощь в подборе аналогов, поставка прототипов;
- Система менеджмента качества сертифицирована по Международному стандарту ISO 9001;
- Лицензия ФСБ на осуществление работ с использованием сведений, составляющих государственную тайну;
- Поставка специализированных компонентов (Xilinx, Altera, Analog Devices, Intersil, Interpoint, Microsemi, Aeroflex, Peregrine, Syfer, Eurofarad, Texas Instrument, Miteq, Cobham, E2V, MA-COM, Hittite, Mini-Circuits, General Dynamics и др.);

Помимо этого, одним из направлений компании «ЭлектроПласт» является направление «Источники питания». Мы предлагаем Вам помощь Конструкторского отдела:

- Подбор оптимального решения, техническое обоснование при выборе компонента;
- Подбор аналогов;
- Консультации по применению компонента;
- Поставка образцов и прототипов;
- Техническая поддержка проекта;
- Защита от снятия компонента с производства.



#### Как с нами связаться

**Телефон:** 8 (812) 309 58 32 (многоканальный)

**Факс:** 8 (812) 320-02-42

**Электронная почта:** [org@eplast1.ru](mailto:org@eplast1.ru)

**Адрес:** 198099, г. Санкт-Петербург, ул. Калинина, дом 2, корпус 4, литера А.