

SWITCHING REGULATOR CONTROL IC

■ GENERAL DESCRIPTION

The NJM2377 is high speed switching regulator control IC which can operate at low voltage.

The NJM2377 consists of low power oscillation circuit, high precision reference, wide band error amplifier, under voltage lockout circuit, and a totem pole output circuit; which can drive an external Bipolar transistor directly.

The NJM2377 is suitable for any portable system, TFT panel to note PC and especially power supply at video CD.

■ PACKAGE OUTLINE

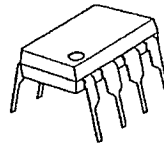

NJM2377D

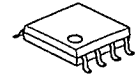

NJM2377M



NJM2377V

■ FEATURES

- PWM Type Switching Regulator Control
- Operating Voltage (2.7~18V)
- Wide Oscillator Range (10~500kHz)
- ON/OFF Maximum Duty Cycle (Ton:Toff=9:1)
- Totem Pole Output
- Soft-Start Function
- Under Voltage Lockouts (U. V. L. O.)
- Bipolar Technology
- Package Outline DIP8, DMP8, SSOP8

■ BLOCK DIAGRAM

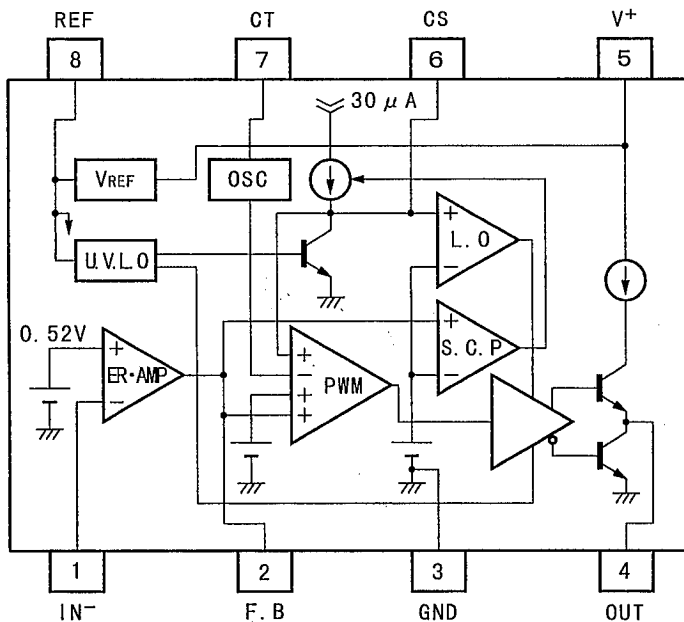

- PIN FUNCTION
1. IN<sup>-</sup>
  2. F. B
  3. GND
  4. OUT
  5. V<sup>+</sup>
  6. CS
  7. CT
  8. REF

■ ABSOLUTE MAXIMUM RATINGS (Ta=25°C)

PARAMETER	SYMBOL	RATINGS	UNIT
Input Voltage	V <sup>+</sup>	18	V
Reference Output Current	I <sub>o</sub>	±50	mA
Power Dissipation	P <sub>D</sub>	(DIP8) 700 (DMP8) 300 (SSOP8) 250	mW
Operating Temperature Range	T <sub>OPR</sub>	-40~+85	°C
Storage Temperature Range	T <sub>STG</sub>	-50~+150	°C

■ RECOMMENDED OPERATING CONDITIONS (V<sup>+</sup>=3V, Ta=25°C)

PARAMETER	SYMBOL	MIN.	MAX.	UNIT
Operating Voltage	V <sup>+</sup>	2.7	18	V
Feed Back Resistor	R <sub>NF</sub>	100	—	k Ω
Oscillator Timing Capacitor	C <sub>T</sub>	220	22,000	p F
Oscillator Timing Resistor	R <sub>T</sub>	5	100	k Ω
Oscillation Frequency	f <sub>osc</sub>	10	500	k H z

■ ELECTRICAL CHARACTERISTICS ( $V^+=3V$ ,  $R_T=39k\Omega$ ,  $C_T=470pF$ ,  $T_a=25^\circ C$ )

REFERENCE VOLTAGE BLOCK

PARAMETER	SYMBOL	TEST CONDITION	MIN.	TYP.	MAX.	UNIT
Output Voltage	$V_{REF}$	$I_{OR}=1mA$	1.47	1.50	1.53	V
Line Regulation	$\Delta V_o - V_{IN}$	$V^+=2.7\sim 18V$ , $I_{OR}=1mA$	—	3.8	11.5	mV
Load Regulation	$\Delta V_o - I_o$	$I_{OR}=0.1\sim 5.0mA$	—	5	30	mA

OSCILLATOR BLOCK

PARAMETER	SYMBOL	TEST CONDITION	MIN.	TYP.	MAX.	UNIT
Oscillation Frequency	$f_{osc}$	$C_T=470pA$ , $R_T=39k\Omega$	80	100	120	kHz
Oscillate Fluctuations1 (Line Fluctuations)	$f_{dv}$	$V^+=2.7\sim 18V$ , $I_{OR}=1mA$	—	1	—	%
Oscillate Fluctuations2 (Temp. Fluctuations)	$f_{dt}$	$T_a=-40\sim +85^\circ C$	—	5	—	%

ERROR AMPLIFIER BLOCK

PARAMETER	SYMBOL	TEST CONDITION	MIN.	TYP.	MAX.	UNIT
Reference Voltage	$V_B$		0.51	0.52	0.53	V
Input Bias Current	$I_B$		—	5	100	nA
Open Loop Gain	$A_v$		—	90	—	dB
Gain Band width Product	$G_B$		—	1.0	—	MHz
Maximum Output Voltage (F. B Pin)	$V_{OM+}$	$R_{NF}=100k\Omega$ , $I_{N- Pin}=0V$	1.9	2.2	2.4	V
	$V_{OM-}$	$R_{NF}=100k\Omega$ , $I_{N- Pin}=1V$	—	—	200	mA
Output Source Current (F. B Pin)	$I_{OM+}$	$V_{OM}=1V$ , $I_{N- Pin}=0V$	40	85	200	$\mu A$

PWM COMPARABLE BLOCK

PARAMETER	SYMBOL	TEST CONDITION	MIN.	TYP.	MAX.	UNIT
Input Bias Voltage (F. B Pin)	$V_{TH0}$	duty·cycle=0%	—	0.45	0.55	V
Input Threshold Voltage (F. B Pin)	$V_{TH80}$	duty·cycle=80%	—	1.05	—	V
Maximum Duty Cycle	$\alpha M$	F. B Pin=1.2V $C_T=470pF$ , $R_T=39k\Omega$	80	90	—	%

SOFT START CIRCUIT BLOCK

PARAMETER	SYMBOL	TEST CONDITION	MIN.	TYP.	MAX.	UNIT
Input Bias Current (GS Pin)	$I_{BCS}$		—	250	650	nA
Input Threshold Voltage (GS Pin)	$V_{THCS0}$	duty·cycle=0% F. B Pin=1.2V	—	0.25	0.35	V
Input Threshold Voltage (GS Pin)	$V_{THCS80}$	duty·cycle=80% F. B Pin=1.2V	—	0.79	—	V

6

■ ELECTRICAL CHARACTERISTICS ( $V^+=3V$ ,  $R_T=39k\Omega$ ,  $C_T=470pF$ ,  $T_a=25^\circ C$ )

SHORT CIRCUIT PROTECTION

PARAMETER	SYMBOL	TEST CONDITION	MIN.	TYP.	MAX.	UNIT
Input Threshold Voltage (F.B Pin)	$V_{THPC}$		1.30	1.50	1.80	V
Charge Current (CS Pin)	$I_{CHG}$	CS Pin=0V, F.B Pin=2V	10	30	50	$\mu A$
Latch mode Threshold Voltage (CS Pin)	$V_{THLA}$		1.20	1.50	1.80	V

UNDER VOLTAGE LOCKOUT

PARAMETER	SYMBOL	TEST CONDITION	MIN.	TYP.	MAX.	UNIT
ON Threshold Voltage	$V_{THON}$		—	1.95	—	V
OFF Threshold Voltage	$V_{THOFF}$		—	1.78	—	V
Hysteresis Voltage	$V_{HYS}$		60	170	—	mV

OUTPUT BLOCK

PARAMETER	SYMBOL	TEST CONDITION	MIN.	TYP.	MAX.	UNIT
H-Output Voltage (OUT Pin)	$V_{OH}$	$R_L=10k\Omega$	1.7	2.0	—	V
L-Output Voltage (OUT Pin)	$V_{OL}$	Output Sink Current=20mA	—	0.25	0.65	V
Output Source Current (OUT Pin)	$I_{SOURCE}$	OUT Pin=0V	23	35	—	mA

GENERAL CHARACTERISTIC

PARAMETER	SYMBOL	TEST CONDITION	MIN.	TYP.	MAX.	UNIT
Quiescent Current	$I_{CCLA}$	Latch Mode, CS Pin=1.8V	—	1.7	2.4	mA
Average Quiescent Current	$I_{CCAV}$	$R_L=\infty$ , duty-cycle=50%	—	5.0	6.8	mA

■ TYPICAL APPLICATION

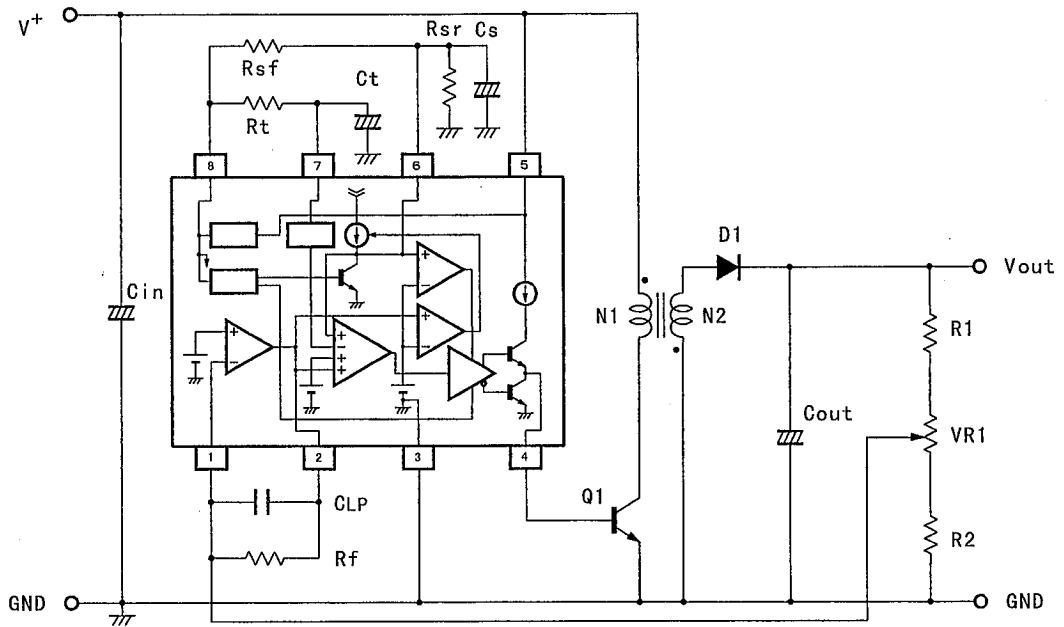

## TYPICAL CHARACTERISTICS

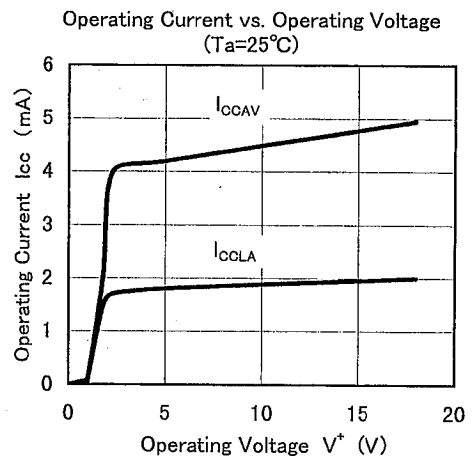
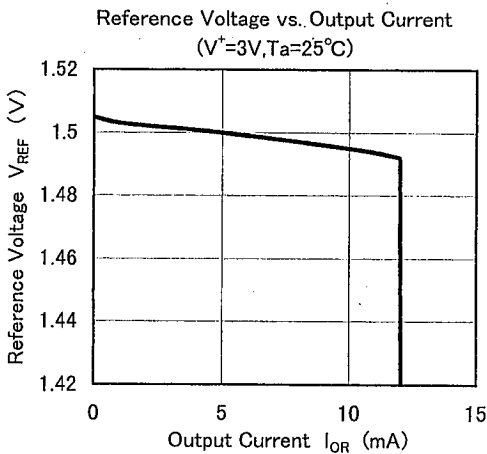
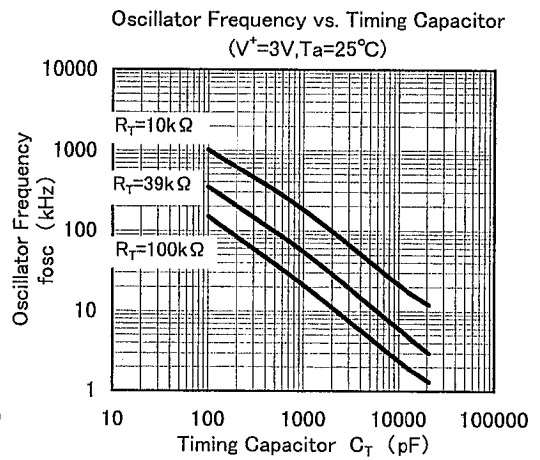
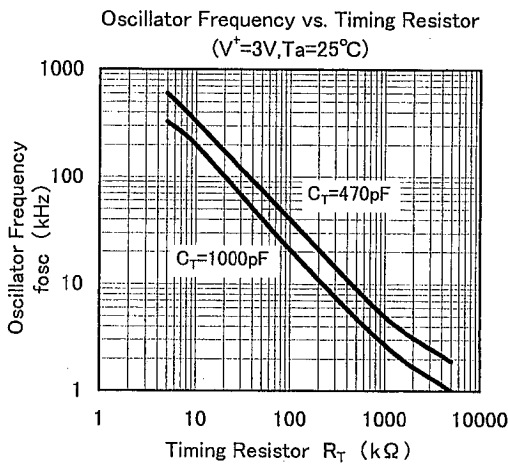
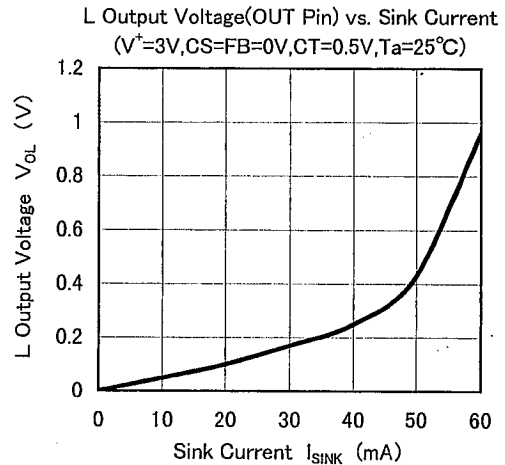
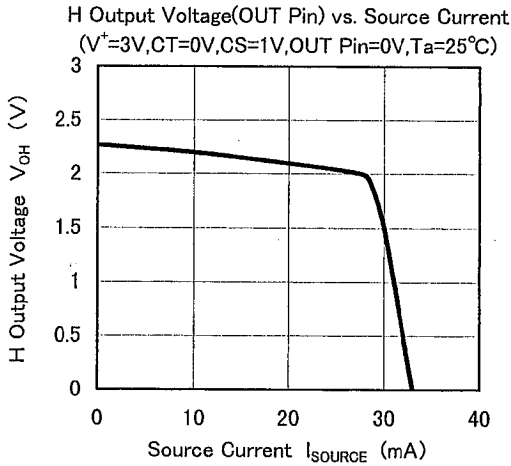

■ TYPICAL CHARACTERISTICS

Maximum Duty Cycle vs. Oscillator Frequency  
( $V^+ = 3V$ )

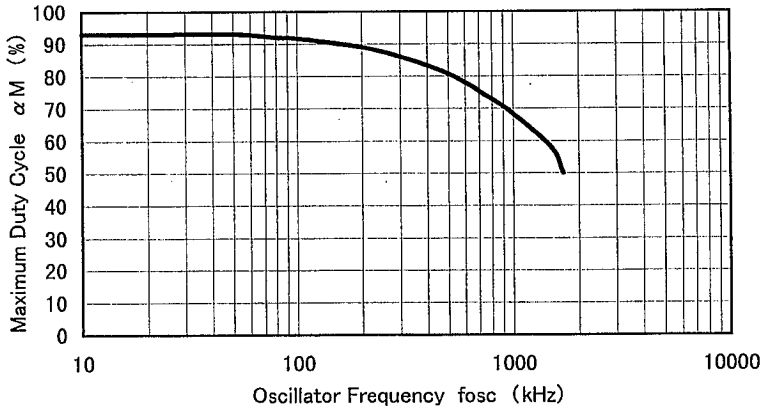

Duty Cycle vs. CS Pin Voltage  
( $V^+ = 3V$ )

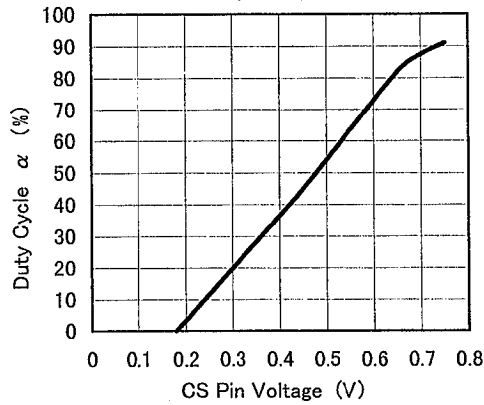

Quiescent Current (Latch Mode) vs. Temperature  
( $V^+ = 3V, CS = 1.8V$ )

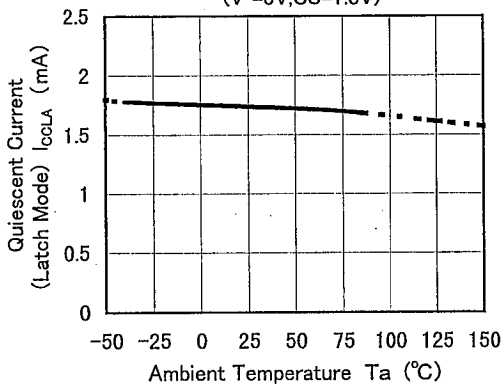

Average Quiescent Current vs. Temperature  
( $V^+ = 3V, R_L = \infty, \text{duty cycle} = 50\%$   
 $R_T = 39k\Omega, C_T = 470pF$ )

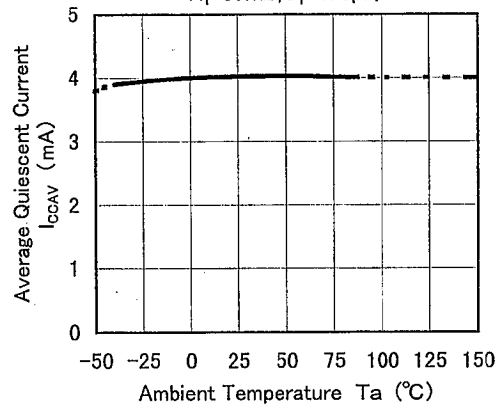

6

## TYPICAL CHARACTERISTICS

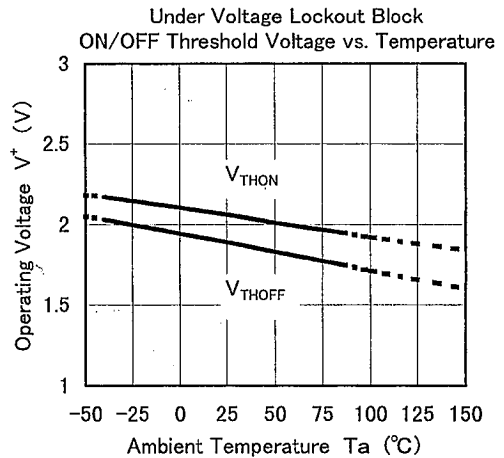
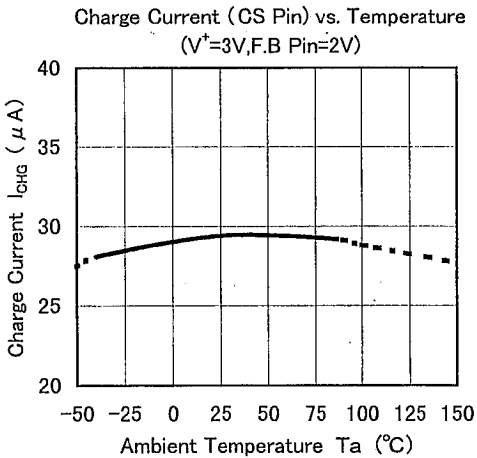
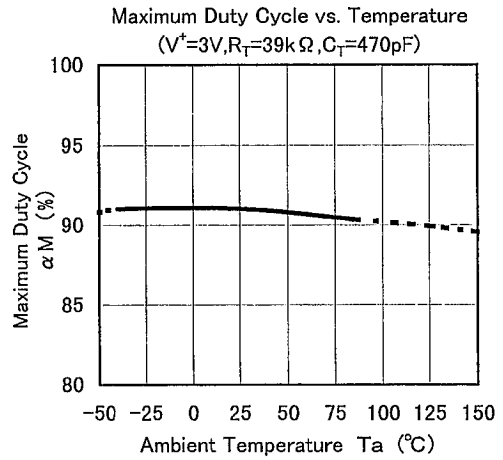
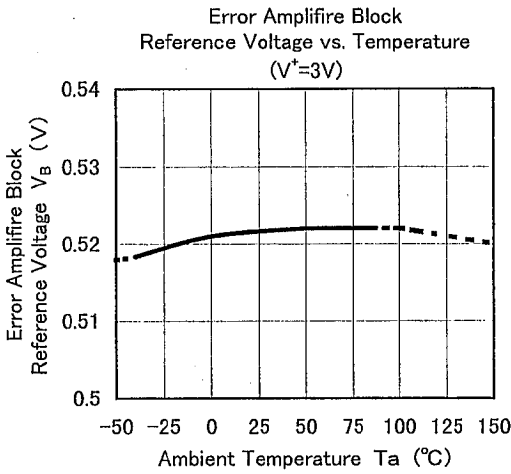
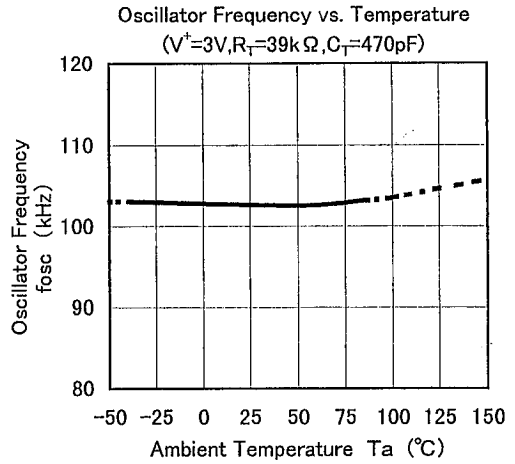
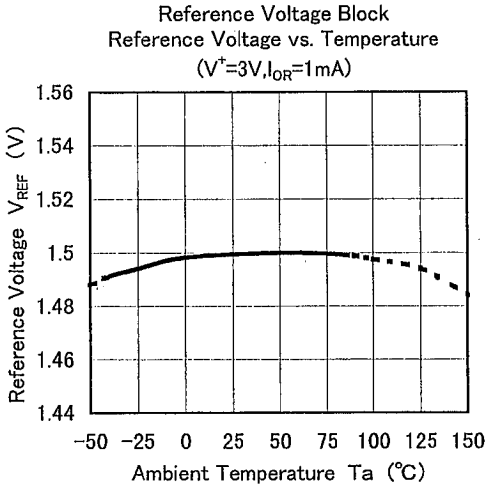



■ TYPICAL CHARACTERISTICS

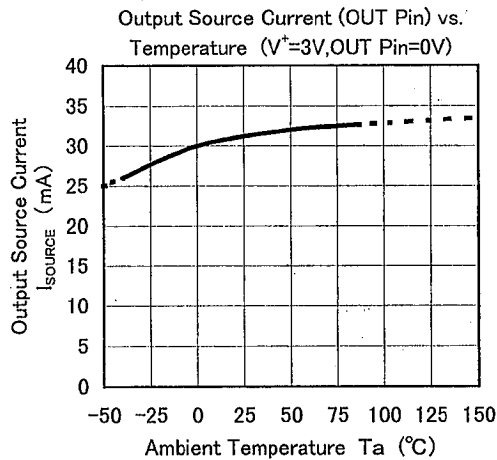
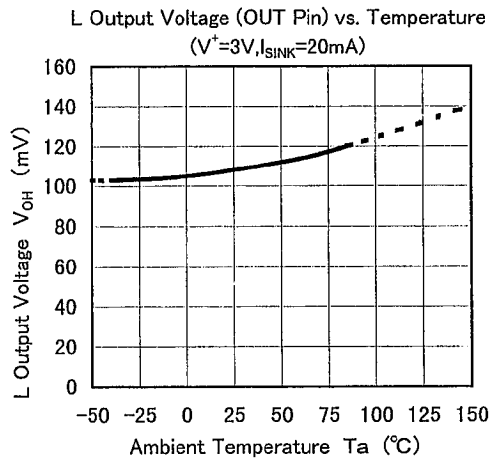
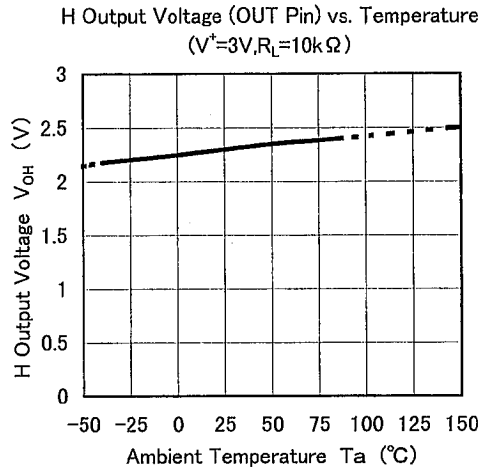

## MEMO

[CAUTION]

The specifications on this databook are only given for information, without any guarantee as regards either mistakes or omissions. The application circuits in this databook are described only to show representative usages of the product and not intended for the guarantee or permission of any right including the industrial rights.



Компания «ЭлектроПласт» предлагает заключение долгосрочных отношений при поставках импортных электронных компонентов на взаимовыгодных условиях!

Наши преимущества:

- Оперативные поставки широкого спектра электронных компонентов отечественного и импортного производства напрямую от производителей и с крупнейших мировых складов;
- Поставка более 17-ти миллионов наименований электронных компонентов;
- Поставка сложных, дефицитных, либо снятых с производства позиций;
- Оперативные сроки поставки под заказ (от 5 рабочих дней);
- Экспресс доставка в любую точку России;
- Техническая поддержка проекта, помощь в подборе аналогов, поставка прототипов;
- Система менеджмента качества сертифицирована по Международному стандарту ISO 9001;
- Лицензия ФСБ на осуществление работ с использованием сведений, составляющих государственную тайну;
- Поставка специализированных компонентов (Xilinx, Altera, Analog Devices, Intersil, Interpoint, Microsemi, Aeroflex, Peregrine, Syfer, Eurofarad, Texas Instrument, Miteq, Cobham, E2V, MA-COM, Hittite, Mini-Circuits, General Dynamics и др.);

Помимо этого, одним из направлений компании «ЭлектроПласт» является направление «Источники питания». Мы предлагаем Вам помощь Конструкторского отдела:

- Подбор оптимального решения, техническое обоснование при выборе компонента;
- Подбор аналогов;
- Консультации по применению компонента;
- Поставка образцов и прототипов;
- Техническая поддержка проекта;
- Защита от снятия компонента с производства.



#### Как с нами связаться

**Телефон:** 8 (812) 309 58 32 (многоканальный)

**Факс:** 8 (812) 320-02-42

**Электронная почта:** [org@eplast1.ru](mailto:org@eplast1.ru)

**Адрес:** 198099, г. Санкт-Петербург, ул. Калинина, дом 2, корпус 4, литера А.