

General Purpose AC/DC EMI Filter



- Rated currents from 1 to 60 A
- High differential-mode attenuation
- Optional medical version (B type)
- Optional safety version (A type)



Performance indicators

Attenuation performance



Rated current [A]



Technical specifications

| | |
|--|---|
| Rated voltage* | 250 VAC, 50/60 Hz; 250 VDC |
| Operating frequency | DC to 400 Hz |
| Rated currents | 1 to 60 A @ 40°C max. |
| High potential test voltage | P → N 760 VAC for 2 sec (1 to 20 A types) P → PE 2500 VAC for 2 sec (B types) P → PE 2000 VAC for 2 sec P → N 1100 VDC for 2 sec (30 and 60 A types) |
| Temperature range (operation and storage) | -25°C to +100°C (25/100/21) |
| Certified to | UL 1283, CSA 22.2 No. 8 1986, IEC/EN 60939 (applies to AC and DC applications) |
| Flammability corresponding to | UL 94 V-2 or better |
| Design corresponding to | UL 1283, CSA 22.2 No. 8 1986, IEC/EN 60939 |
| MTBF @ 40°C/230 V (Mil-HB-217F) | 1,250,000 hours 1,750,000 hours (B types) |

*maximum RMS operating voltage at rated frequency or the maximum DC operating voltage

Approvals



Features and benefits

- FN 2020 filters are designed for easy and fast chassis mounting
- FN 2020 filters are also available as B versions without Y-capacitors for medical applications as well as A version with low capacitance for safety critical applications with necessity for low leakage currents
- All filters provide a general purpose conducted attenuation performance, based on chokes with high saturation resistance and excellent thermal behavior
- FN 2020 filters can be used to cover a broad range of usage and they offer a good size/amperage ratio
- FN 2020 filters are also available as two-stage filters (FN 2060, FN 2070 series) for more noisy environment
- Various terminal options allow you to select the desired connection style

Typical applications

- Electrical and electronic equipment
- Consumer goods
- Household equipment
- Medical equipment
- Office automation equipment
- Datacom equipment

Typical electrical schematic

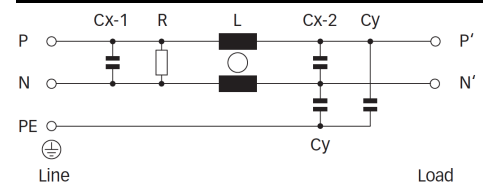

Filter selection table

| Filter* | Rated current | Leakage current** @ 250 VAC/50 Hz (@ 120 VAC/60 Hz) | Inductance L | Capacitance | | Resistance R | Input/Output connections | | | Weight [g] |
|----------------|---------------|---|-----------------|-------------|------|-----------------|---|---|---|---------------|
| | @ 40°C (25°C) | | | Cx | Cy | | | | | |
| | [A] | [mA] | [mH] | [µF] | [nF] | [kΩ] |  |  |  | |
| FN 2020-1-.. | 1 (1.15) | 0.66 (0.38) | 12 | 0.15 | 4.7 | 1000 | -06 | -07 | | 80 |
| FN 2020-3-.. | 3 (3.45) | 0.66 (0.38) | 2.5 | 0.15 | 4.7 | 1000 | -06 | -07 | | 80 |
| FN 2020-6-.. | 6 (6.9) | 0.66 (0.38) | 1 | 0.15 | 4.7 | 1000 | -06 | -07 | | 80 |
| FN 2020-10-.. | 10 (11.5) | 0.66 (0.38) | 0.8 | 0.15 | 4.7 | 1000 | -06 | -07 | | 85 |
| FN 2020-12-.. | 12 (13.8) | 0.66 (0.38) | 0.7 | 0.15 | 4.7 | 1000 | -06 | -07 | | 85 |
| FN 2020-16-.. | 16 (18.4) | 0.66 (0.38) | 0.65 | 0.15 | 4.7 | 1000 | -06 | -07 | | 140 |
| FN 2020-20-.. | 20 (23) | 0.66 (0.38) | 0.6 | 0.15 | 4.7 | 1000 | -06 | | -08 | 210 |
| FN 2020-30-08 | 30 (34.5) | 0.79 (0.45) | 0.67 | 0.47 | 10 | 470 | | | -08 | 470 |
| FN 2020-60-24 | 60 (69) | 0.79 (0.45) | 1 | 1.5 | 10 | 220 | | | -24 | 1100 |
| FN 2020A-1-.. | 1 (1.15) | 0.07 (0.04) | 12 | 0.15 | 0.47 | 1000 | -06 | -07 | | 80 |
| FN 2020A-3-.. | 3 (3.45) | 0.07 (0.04) | 2.5 | 0.15 | 0.47 | 1000 | -06 | -07 | | 80 |
| FN 2020A-6-.. | 6 (6.9) | 0.07 (0.04) | 1 | 0.15 | 0.47 | 1000 | -06 | -07 | | 80 |
| FN 2020A-10-.. | 10 (11.5) | 0.07 (0.04) | 0.8 | 0.15 | 0.47 | 1000 | -06 | -07 | | 85 |
| FN 2020A-12-.. | 12 (13.8) | 0.07 (0.04) | 0.7 | 0.15 | 0.47 | 1000 | -06 | -07 | | 85 |
| FN 2020A-16-.. | 16 (18.4) | 0.07 (0.04) | 0.65 | 0.15 | 0.47 | 1000 | -06 | -07 | | 140 |
| FN 2020A-20-.. | 20 (23) | 0.07 (0.04) | 0.6 | 0.15 | 0.47 | 1000 | -06 | | -08 | 210 |
| FN 2020A-30-08 | 30 (34.5) | 0.07 (0.04) | 0.67 | 0.47 | 0.47 | 470 | | | -08 | 470 |
| FN 2020A-60-24 | 60 (69) | 0.07 (0.04) | 1 | 1.5 | 0.47 | 220 | | | -24 | 1100 |
| FN 2020B-1-.. | 1 (1.15) | 0.00 | 12 | 0.15 | | 1000 | -06 | -07 | | 80 |
| FN 2020B-3-.. | 3 (3.45) | 0.00 | 2.5 | 0.15 | | 1000 | -06 | -07 | | 80 |
| FN 2020B-6-.. | 6 (6.9) | 0.00 | 1 | 0.15 | | 1000 | -06 | -07 | | 80 |
| FN 2020B-10-.. | 10 (11.5) | 0.00 | 0.8 | 0.15 | | 1000 | -06 | -07 | | 85 |
| FN 2020B-12-.. | 12 (13.8) | 0.00 | 0.7 | 0.15 | | 1000 | -06 | -07 | | 85 |
| FN 2020B-16-.. | 16 (18.4) | 0.00 | 0.65 | 0.15 | | 1000 | -06 | -07 | | 140 |
| FN 2020B-20-.. | 20 (23) | 0.00 | 0.6 | 0.15 | | 1000 | -06 | | -08 | 210 |
| FN 2020B-30-08 | 30 (34.5) | 0.00 | 0.67 | 0.47 | | 470 | | | -08 | 470 |
| FN 2020B-60-24 | 60 (69) | 0.00 | 1 | 1.5 | | 220 | | | -24 | 1100 |

* To compile a complete part number, please replace the .. with the required I/O connection style (e.g. FN 2020-30-08, FN 2020B-10-06).

** Maximum leakage under usual AC operating conditions (acc. IEC 60939-3). Note: if the neutral line is interrupted, worst case leakage could reach twice this level. Leakage current for DC application is 0 mA;

Typical filter attenuation

Per CISPR 17; A=50 Ω/50 Ω sym; B=50 Ω/50 Ω asym; C=0.1 Ω/100 Ω sym; D=100 Ω/0.1 Ω sym

1 and 3 A types



6 to 12 A types



16 and 20 A types



30 and 60 A types



Mechanical data



Dimensions

| | 1 A | 3 A | 6 A | 10 A | 12 A | 16 A | 20 A | 30 A | 60 A | Tolerances |
|--------------------------------|-----------|-----------|-----------|-----------|-----------|-----------|-----------|-----------|----------|------------|
| A | 64 | 64 | 64 | 64 | 64 | 71 | 85 | 113.5 ±1 | 105 ±1 | ±0.5 |
| B | 35 | 35 | 35 | 35 | 35 | 46.6 | 54 | 57.5 ±1 | 145.9 ±1 | ±0.5 |
| C | 29.3 | 29.3 | 29.3 | 29.3 | 29.3 | 29.3 | 30.3 | 45.4 ±1 | 57.6 ±1 | ±0.5 |
| D | 43.5 | 43.5 | 43.5 | 43.5 | 43.5 | 50.5 | 64.8 | 94 ±1 | 84.5 ±1 | ±0.5 |
| E | 32.5 | 32.5 | 32.5 | 32.5 | 32.5 | 44.5 | 49.8 | 56 | 99.5 | ±0.5 |
| F | 54 | 54 | 54 | 54 | 54 | 61 | 75 | 103 | 95 | ±0.3 |
| G | 21 | 21 | 21 | 21 | 21 | 21 | 27 | 25 | 40 | ±0.2 |
| H | 9.3 | 9.3 | 9.3 | 9.3 | 9.3 | 10.8 | 12.3 | 12.4 | 19.6 | ±0.5 |
| I | 15.3 | 15.3 | 15.3 | 15.3 | 15.3 | 19.3 | 20.8 | 32.4 | 10.1 | ±0.5 |
| J | 21.8 | 21.8 | 21.8 | 21.8 | 21.8 | 20.1 | 19.9 | 15.5 | 42.25 | ±0.5 |
| K | 5.3 | 5.3 | 5.3 | 5.3 | 5.3 | 5.3 | 5.3 | 4.4 | 4.4 | |
| L | 6.3 | 6.3 | 6.3 | 6.3 | 6.3 | 6.3 | 6.3 | 6 | 6 | |
| M | 0.7 | 0.7 | 0.7 | 0.7 | 0.7 | 0.7 | 0.7 | 0.9 | 1.2 | |
| Connection style -06 | | | | | | | | | | |
| N | 6.3 x 0.8 | 6.3 x 0.8 | 6.3 x 0.8 | 6.3 x 0.8 | 6.3 x 0.8 | 6.3 x 0.8 | 6.3 x 0.8 | | | |
| Connection style -07 | | | | | | | | | | |
| O | 8.3 | 8.3 | 8.3 | 8.3 | 8.3 | 8.3 | | | | ±0.5 |
| P | 21.8 | 21.8 | 21.8 | 21.8 | 21.8 | 14 | | | | ±0.5 |
| AWG type wire | AWG 20 | AWG 20 | AWG 18 | AWG 18 | AWG 16 | AWG 16 | | | | |
| Wire length | 140 | 140 | 140 | 140 | 140 | 140 | | | | +5 |
| Connection style -08 | | | | | | | | | | |
| N | | | | | | | M4 | M4 | | |
| Recommended torque (Nm) | | | | | | | 1.2 - 1.3 | 1.2 - 1.3 | | |
| Connection style -24 | | | | | | | | | | |
| N | | | | | | | | | M6 | |
| Q | | | | | | | | | 51 | ±0.2 |
| Recommended torque (Nm) | | | | | | | | | 3.5 - 4 | |

All dimensions in mm; 1 inch = 25.4 mm
Tolerances according: ISO 2768-m/EN 22768-m

Please visit www.schaffner.com to find more details on filter connections.



Headquarters, global innovation and development

Switzerland

Schaffner Group

Nordstrasse 11
4542 Luterbach
T +41 32 681 66 26
info@schaffner.com
www.schaffner.com



Sales and application centers

China

Schaffner EMC Ltd. Shanghai

T20-3 C, No 565 Chuangye Road,
Pudong district
201201 Shanghai
T +86 21 3813 9500
cschina@schaffner.com
www.schaffner.com.cn

Finland

Schaffner Oy

Sauvonrinne 19 H
08500 Lohja
T +358 50 468 7284
finlandsales@schaffner.com

France

Schaffner EMC S.A.S.

16-20 Rue Louis Rameau
95875 Bezons
T +33 1 34 34 30 60
F +33 1 39 47 02 28
francesales@schaffner.com

Germany

Schaffner Deutschland GmbH

Schoemperlenstrasse 12B
76185 Karlsruhe
T +49 721 56910
F +49 721 569110
germanysales@schaffner.com

India

Schaffner India Pvt. Ltd

REGUS WORLD TRADE CENTRE
WTC, 22nd Floor Unit No 2238, Brigade
Gateway Campus, 26/1, Dr. Rajkumar Road
Mallechwaram (W)
560055 Bangalore
T +91 80 67935355
indiasales@schaffner.com

Italy

Schaffner EMC S.r.l.

Via Ticino, 30
20900 Monza (MB)
T +39 039 21 41 070
italysales@schaffner.com

Japan

Schaffner EMC K.K.

1-32-12, Kamiyama, Setagaya-ku
7F Mitsui-seimei Sangenjaya Bldg.
154-0011 Tokyo
T +81 3 5712 3650
F +81 3 5712 3651
japansales@schaffner.com
www.schaffner.jp

Singapore

Schaffner EMC Pte Ltd.

#05-09, Kg Ubi Ind. Estate
408705 Singapore
T +65 6377 3283
F +65 6377 3281
singaporesales@schaffner.com

Spain

Schaffner EMC España

Calle Caléndula 93, Miniparc III, Edificio E
El Soto de Moraleja, Alcobendas
28109 Madrid
T +34 917 912 900
F +34 917 912 901
spainsales@schaffner.com

Sweden

Schaffner EMC AB

Tegeluddsvägen 76, 2tr
115 28 Stockholm
T +46 8 5050 2425
swedensales@schaffner.com
www.schaffner.com

Switzerland

Schaffner EMV AG

Nordstrasse 11
4542 Luterbach
T +41 32 681 66 26
switzerlandsales@schaffner.com

Taiwan R.O.C.

Schaffner EMV Ltd.

20 Floor-2, No 97, Section 1, XinTai 5th Road
22175 XiZhi District New Taipei City 22175
T +886 2 2697 5500
F +886 2 2697 5533
taiwansales@schaffner.com
www.schaffner.com.tw

Thailand

Schaffner EMC Co. Ltd.

Northern Region Industrial Estate
67 Moo 4 Tambon Ban Klang
Amphur Muangng P.O. Box 14
51000 Lamphun
T +66 53 58 11 04
F +66 53 58 10 19
thailandsales@schaffner.com

United Kingdom

Schaffner Ltd.

5 Ashville Way, Molly Millars Lane
Wokingham
RG41 2PL Berkshire
T +44 118 9770070
F +44 118 9792969
uksales@schaffner.com

USA

Schaffner EMC Inc.

52 Mayfield Avenue
08837 Edison, New Jersey
T +1 800 367 5566
T +1 732 225 9533
F +1 732 225 4789
usasales@schaffner.com
www.schaffnerusa.com

Schaffner North America

6722 Thirlane Road
24019 Roanoke, Virginia
T +1 276 228 7943
F +1 276 228 7953

Schaffner North America

823 Fairview Road
24382 Wytheville, Virginia
T +1 276 228 7943
F +1 276 228 7258

To find your local partner within Schaffner's global network: www.schaffner.com

© 2018 Schaffner Group

The content of this document has been carefully checked and understood. However, neither Schaffner nor its subsidiaries assume any liability whatsoever for any errors or inaccuracies of this document and the consequences thereof. Published specifications are subject to change without notice. Product suitability for any area of application must ultimately be determined by the customer. In all cases, products must never be operated outside their published specifications. Schaffner does not guarantee the availability of all published products. This disclaimer shall be governed by substantive Swiss law and resulting disputes shall be settled by the courts at the place of business of Schaffner Holding AG. Latest publications and a complete disclaimer can be downloaded from the Schaffner website. All trademarks recognized.



Компания «ЭлектроПласт» предлагает заключение долгосрочных отношений при поставках импортных электронных компонентов на взаимовыгодных условиях!

Наши преимущества:

- Оперативные поставки широкого спектра электронных компонентов отечественного и импортного производства напрямую от производителей и с крупнейших мировых складов;
- Поставка более 17-ти миллионов наименований электронных компонентов;
- Поставка сложных, дефицитных, либо снятых с производства позиций;
- Оперативные сроки поставки под заказ (от 5 рабочих дней);
- Экспресс доставка в любую точку России;
- Техническая поддержка проекта, помощь в подборе аналогов, поставка прототипов;
- Система менеджмента качества сертифицирована по Международному стандарту ISO 9001;
- Лицензия ФСБ на осуществление работ с использованием сведений, составляющих государственную тайну;
- Поставка специализированных компонентов (Xilinx, Altera, Analog Devices, Intersil, Interpoint, Microsemi, Aeroflex, Peregrine, Syfer, Eurofarad, Texas Instrument, Miteq, Cobham, E2V, MA-COM, Hittite, Mini-Circuits, General Dynamics и др.);

Помимо этого, одним из направлений компании «ЭлектроПласт» является направление «Источники питания». Мы предлагаем Вам помощь Конструкторского отдела:

- Подбор оптимального решения, техническое обоснование при выборе компонента;
- Подбор аналогов;
- Консультации по применению компонента;
- Поставка образцов и прототипов;
- Техническая поддержка проекта;
- Защита от снятия компонента с производства.



Как с нами связаться

Телефон: 8 (812) 309 58 32 (многоканальный)

Факс: 8 (812) 320-02-42

Электронная почта: org@eplast1.ru

Адрес: 198099, г. Санкт-Петербург, ул. Калинина, дом 2, корпус 4, литера А.