

NCS2001, NCV2001

0.9 V, Rail-to-Rail, Single Operational Amplifier

The NCS2001 is an industry first sub-one voltage operational amplifier that features a rail-to-rail common mode input voltage range, along with rail-to-rail output drive capability. This amplifier is guaranteed to be fully operational down to 0.9 V, providing an ideal solution for powering applications from a single cell Nickel Cadmium (NiCd) or Nickel Metal Hydride (NiMH) battery. Additional features include no output phase reversal with overdriven inputs, trimmed input offset voltage of 0.5 mV, extremely low input bias current of 40 pA, and a unity gain bandwidth of 1.4 MHz at 5.0 V. The tiny NCS2001 is the ideal solution for small portable electronic applications and is available in the space saving SOT23-5 and SC70-5 packages with two industry standard pinouts.

Features

- 0.9 V Guaranteed Operation
- Rail-to-Rail Common Mode Input Voltage Range
- Rail-to-Rail Output Drive Capability
- No Output Phase Reversal for Over-Driven Input Signals
- 0.5 mV Trimmed Input Offset
- 10 pA Input Bias Current
- 1.4 MHz Unity Gain Bandwidth at ± 2.5 V, 1.1 MHz at ± 0.5 V
- Tiny SC70-5 and SOT23-5 Packages
- NCV Prefix for Automotive and Other Applications Requiring Site and Control Changes
- These are Pb-Free Devices

Typical Applications

- Single Cell NiCd/NiMH Battery Powered Applications
- Cellular Telephones
- Pagers
- Personal Digital Assistants
- Electronic Games
- Digital Cameras
- Camcorders
- Hand-Held Instruments

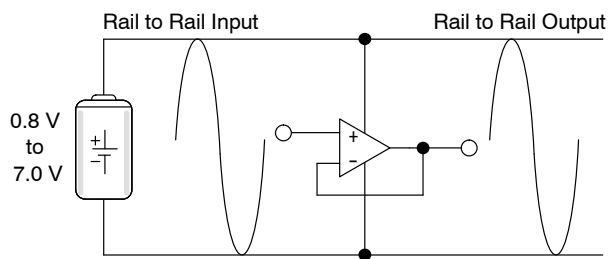

This device contains 63 active transistors.

Figure 1. Typical Application



ON Semiconductor®

<http://onsemi.com>

MARKING DIAGRAMS



SOT23-5
SN SUFFIX
CASE 483

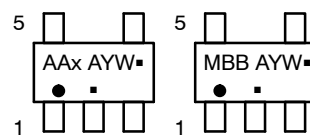

NCV2001SN2



SC70-5
SQ SUFFIX
CASE 419A

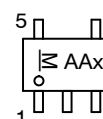

x = G for SN1
H for SN2
I for SQ1
J for SQ2
A = Assembly Location
Y = Year
W = Work Week
M = Date Code
▪ = Pb-Free Package

(Note: Microdot may be in either location)

PIN CONNECTIONS

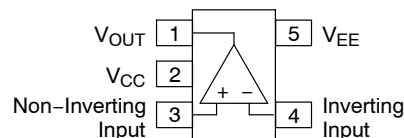

Style 1 Pinout (SN1T1, SQ1T2)

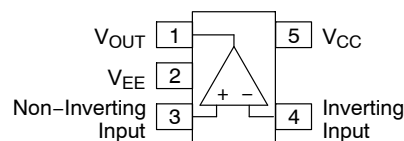

Style 2 Pinout (SN2T1, SQ2T2)

ORDERING INFORMATION

See detailed ordering and shipping information in the dimensions section on page 14 of this data sheet.

NCS2001, NCV2001

MAXIMUM RATINGS

Rating	Symbol	Value	Unit
Supply Voltage (V_{CC} to V_{EE})	V_S	7.0	V
Input Differential Voltage Range (Note 1)	V_{IDR}	$V_{EE} - 300$ mV to 7.0 V	V
Input Common Mode Voltage Range (Note 1)	V_{ICR}	$V_{EE} - 300$ mV to 7.0 V	V
Output Short Circuit Duration (Note 2)	t_{sc}	Indefinite	sec
Junction Temperature	T_J	150	°C
Power Dissipation and Thermal Characteristics			
SOT23-5 Package			
Thermal Resistance, Junction-to-Air	$R_{\theta JA}$	235	°C/W
Power Dissipation @ $T_A = 70^\circ\text{C}$	P_D	340	mW
SC70-5 Package			
Thermal Resistance, Junction-to-Air	$R_{\theta JA}$	280	°C/W
Power Dissipation @ $T_A = 70^\circ\text{C}$	P_D	286	mW
Operating Ambient Temperature Range	T_A		°C
NCS2001		-40 to +105	
NCV2001 (Note 3)		-40 to +125	
Storage Temperature Range	T_{stg}	-65 to 150	°C
ESD Protection at any Pin Human Body Model (Note 4)	V_{ESD}	2000	V

Stresses exceeding Maximum Ratings may damage the device. Maximum Ratings are stress ratings only. Functional operation above the Recommended Operating Conditions is not implied. Extended exposure to stresses above the Recommended Operating Conditions may affect device reliability.

1. Either or both inputs should not exceed the range of $V_{EE} - 300$ mV to $V_{EE} + 7.0$ V.
2. Maximum package power dissipation limits must be observed to ensure that the maximum junction temperature is not exceeded.
 $T_J = T_A + (P_D R_{\theta JA})$.
3. NCV prefix is qualified for automotive usage.
4. ESD data available upon request.

DC ELECTRICAL CHARACTERISTICS

($V_{CC} = 2.5$ V, $V_{EE} = -2.5$ V, $V_{CM} = V_O = 0$ V, R_L to GND, $T_A = 25^\circ\text{C}$ unless otherwise noted.)

Characteristics	Symbol	Min	Typ	Max	Unit
Input Offset Voltage $V_{CC} = 0.45$ V, $V_{EE} = -0.45$ V $T_A = 25^\circ\text{C}$ $T_A = 0^\circ\text{C}$ to 70°C $T_A = -40^\circ\text{C}$ to 125°C	V_{IO}	-6.0 -8.5 -9.5	0.5 - -	6.0 8.5 9.5	mV
$V_{CC} = 1.5$ V, $V_{EE} = -1.5$ V $T_A = 25^\circ\text{C}$ $T_A = 0^\circ\text{C}$ to 70°C $T_A = -40^\circ\text{C}$ to 125°C		-6.0 -7.0 -7.5	0.5 - -	6.0 7.0 7.5	
$V_{CC} = 2.5$ V, $V_{EE} = -2.5$ V $T_A = 25^\circ\text{C}$ $T_A = 0^\circ\text{C}$ to 70°C $T_A = -40^\circ\text{C}$ to 125°C		-6.0 -7.5 -7.5	0.5 - -	6.0 7.5 7.5	
Input Offset Voltage Temperature Coefficient ($R_S = 50$) $T_A = -40^\circ\text{C}$ to 125°C	$\Delta V_{IO}/\Delta T$	-	8.0	-	$\mu\text{V}/^\circ\text{C}$
Input Bias Current ($V_{CC} = 1.0$ V to 5.0 V)	I_{IB}	-	10	-	pA
Input Common Mode Voltage Range	V_{ICR}	-	V_{EE} to V_{CC}	-	V
Large Signal Voltage Gain $V_{CC} = 0.45$ V, $V_{EE} = -0.45$ V $R_L = 10$ k $R_L = 2.0$ k	A_{VOL}	- -	40 20	- -	kV/V
$V_{CC} = 1.5$ V, $V_{EE} = -1.5$ V $R_L = 10$ k $R_L = 2.0$ k		- -	40 40	- -	
$V_{CC} = 2.5$ V, $V_{EE} = -2.5$ V $R_L = 10$ k $R_L = 2.0$ k		20 15	40 40	- -	

NCS2001, NCV2001

DC ELECTRICAL CHARACTERISTICS (continued)

($V_{CC} = 2.5\text{ V}$, $V_{EE} = -2.5\text{ V}$, $V_{CM} = V_O = 0\text{ V}$, R_L to GND, $T_A = 25^\circ\text{C}$ unless otherwise noted.)

Characteristics	Symbol	Min	Typ	Max	Unit
Output Voltage Swing, High State Output ($V_{ID} = +0.5\text{ V}$)	V_{OH}				V
$V_{CC} = 0.45\text{ V}$, $V_{EE} = -0.45\text{ V}$					
$T_A = 25^\circ\text{C}$					
$R_L = 10\text{ k}$		0.40	0.494	-	
$R_L = 2.0\text{ k}$		0.35	0.466	-	
$T_A = 0^\circ\text{C to } 70^\circ\text{C}$					
$R_L = 10\text{ k}$		0.40	-	-	
$R_L = 2.0\text{ k}$		0.35	-	-	
$T_A = -40^\circ\text{C to } 125^\circ\text{C}$					
$R_L = 10\text{ k}$		0.40	-	-	
$R_L = 2.0\text{ k}$		0.35	-	-	
$V_{CC} = 1.5\text{ V}$, $V_{EE} = -1.5\text{ V}$					
$T_A = 25^\circ\text{C}$					
$R_L = 10\text{ k}$		1.45	1.498	-	
$R_L = 2.0\text{ k}$		1.40	1.480	-	
$T_A = 0^\circ\text{C to } 70^\circ\text{C}$					
$R_L = 10\text{ k}$		1.45	-	-	
$R_L = 2.0\text{ k}$		1.40	-	-	
$T_A = -40^\circ\text{C to } 125^\circ\text{C}$					
$R_L = 10\text{ k}$		1.45	-	-	
$R_L = 2.0\text{ k}$		1.40	-	-	
$V_{CC} = 2.5\text{ V}$, $V_{EE} = -2.5\text{ V}$					
$T_A = 25^\circ\text{C}$					
$R_L = 10\text{ k}$		2.45	2.498	-	
$R_L = 2.0\text{ k}$		2.40	2.475	-	
$T_A = 0^\circ\text{C to } 70^\circ\text{C}$					
$R_L = 10\text{ k}$		2.45	-	-	
$R_L = 2.0\text{ k}$		2.40	-	-	
$T_A = -40^\circ\text{C to } 125^\circ\text{C}$					
$R_L = 10\text{ k}$		2.45	-	-	
$R_L = 2.0\text{ k}$		2.40	-	-	
Output Voltage Swing, Low State Output ($V_{ID} = -0.5\text{ V}$)	V_{OL}				V
$V_{CC} = 0.45\text{ V}$, $V_{EE} = -0.45\text{ V}$					
$T_A = 25^\circ\text{C}$					
$R_L = 10\text{ k}$		-	-0.494	-0.40	
$R_L = 2.0\text{ k}$		-	-0.480	-0.35	
$T_A = 0^\circ\text{C to } 70^\circ\text{C}$					
$R_L = 10\text{ k}$		-	-	-0.40	
$R_L = 2.0\text{ k}$		-	-	-0.35	
$T_A = -40^\circ\text{C to } 125^\circ\text{C}$					
$R_L = 10\text{ k}$		-	-	-0.40	
$R_L = 2.0\text{ k}$		-	-	-0.35	
$V_{CC} = 1.5\text{ V}$, $V_{EE} = -1.5\text{ V}$					
$T_A = 25^\circ\text{C}$					
$R_L = 10\text{ k}$		-	-1.493	-1.45	
$R_L = 2.0\text{ k}$		-	-1.480	-1.40	
$T_A = 0^\circ\text{C to } 70^\circ\text{C}$					
$R_L = 10\text{ k}$		-	-	-1.45	
$R_L = 2.0\text{ k}$		-	-	-1.40	
$T_A = -40^\circ\text{C to } 125^\circ\text{C}$					
$R_L = 10\text{ k}$		-	-	-1.45	
$R_L = 2.0\text{ k}$		-	-	-1.40	
$V_{CC} = 2.5\text{ V}$, $V_{EE} = -2.5\text{ V}$					
$T_A = 25^\circ\text{C}$					
$R_L = 10\text{ k}$		-	-2.492	-2.45	
$R_L = 2.0\text{ k}$		-	-2.479	-2.40	
$T_A = 0^\circ\text{C to } 70^\circ\text{C}$					
$R_L = 10\text{ k}$		-	-	-2.45	
$R_L = 2.0\text{ k}$		-	-	-2.40	
$T_A = -40^\circ\text{C to } 125^\circ\text{C}$					
$R_L = 10\text{ k}$		-	-	-2.45	
$R_L = 2.0\text{ k}$		-	-	-2.40	

NCS2001, NCV2001

DC ELECTRICAL CHARACTERISTICS (continued)

($V_{CC} = 2.5\text{ V}$, $V_{EE} = -2.5\text{ V}$, $V_{CM} = V_O = 0\text{ V}$, R_L to GND, $T_A = 25^\circ\text{C}$ unless otherwise noted.)

Characteristics	Symbol	Min	Typ	Max	Unit
Common Mode Rejection Ratio ($V_{in} = 0$ to 5.0 V)	CMRR	60	70	-	dB
Power Supply Rejection Ratio ($V_{CC} = 0.5\text{ V}$ to 2.5 V , $V_{EE} = -2.5\text{ V}$)	PSRR	55	65	-	dB
Output Short Circuit Current $V_{CC} = 0.45\text{ V}$, $V_{EE} = -0.45\text{ V}$, $V_{ID} = \pm 0.4\text{ V}$ Source Current High Output State Sink Current Low Output State $V_{CC} = 1.5\text{ V}$, $V_{EE} = -1.5\text{ V}$, $V_{ID} = \pm 0.5\text{ V}$ Source Current High Output State Sink Current Low Output State $V_{CC} = 2.5\text{ V}$, $V_{EE} = -2.5\text{ V}$, $V_{ID} = \pm 0.5\text{ V}$ Source Current High Output State Sink Current Low Output State	I_{SC}	0.5 - 15 - 40 -	1.2 -3.0 29 -40 76 -96	- -1.5 - -20 - -50	mA
Power Supply Current (Per Amplifier, $V_O = 0\text{ V}$) $V_{CC} = 0.45\text{ V}$, $V_{EE} = -0.45\text{ V}$ $T_A = 25^\circ\text{C}$ $T_A = 0^\circ\text{C}$ to 70°C $T_A = -40^\circ\text{C}$ to 125°C $V_{CC} = 1.5\text{ V}$, $V_{EE} = -1.5\text{ V}$ $T_A = 25^\circ\text{C}$ $T_A = 0^\circ\text{C}$ to 70°C $T_A = -40^\circ\text{C}$ to 125°C $V_{CC} = 2.5\text{ V}$, $V_{EE} = -2.5\text{ V}$ $T_A = 25^\circ\text{C}$ $T_A = 0^\circ\text{C}$ to 70°C $T_A = -40^\circ\text{C}$ to 125°C	I_D	- - - - - - - - - - -	0.51 - - - 0.72 - - - 0.82 - - -	1.10 1.10 1.10 1.40 1.40 1.40 1.50 1.50 1.50	mA

AC ELECTRICAL CHARACTERISTICS

($V_{CC} = 2.5\text{ V}$, $V_{EE} = -2.5\text{ V}$, $V_{CM} = V_O = 0\text{ V}$, R_L to GND, $T_A = 25^\circ\text{C}$ unless otherwise noted.)

Characteristics	Symbol	Min	Typ	Max	Unit
Differential Input Resistance ($V_{CM} = 0\text{ V}$)	R_{in}	-	> 1.0	-	tera Ω
Differential Input Capacitance ($V_{CM} = 0\text{ V}$)	C_{in}	-	3.0	-	pF
Equivalent Input Noise Voltage ($f = 1.0\text{ kHz}$)	e_n	-	100	-	nV/ $\sqrt{\text{Hz}}$
Gain Bandwidth Product ($f = 100\text{ kHz}$) $V_{CC} = 0.45\text{ V}$, $V_{EE} = -0.45\text{ V}$ $V_{CC} = 1.5\text{ V}$, $V_{EE} = -1.5\text{ V}$ $V_{CC} = 2.5\text{ V}$, $V_{EE} = -2.5\text{ V}$	GBW	- - 0.5	1.1 1.3 1.4	- - -	MHz
Gain Margin ($R_L = 10\text{ k}$, $C_L = 5.0\text{ pf}$)	A_m	-	6.5	-	dB
Phase Margin ($R_L = 10\text{ k}$, $C_L = 5.0\text{ pf}$)	ϕ_m	-	60	-	$^\circ$
Power Bandwidth ($V_O = 4.0\text{ V}_{pp}$, $R_L = 2.0\text{ k}$, THD = 1.0%, $A_V = 1.0$)	BW_P	-	80	-	kHz
Total Harmonic Distortion ($V_O = 4.0\text{ V}_{pp}$, $R_L = 2.0\text{ k}$, $A_V = 1.0$) $f = 1.0\text{ kHz}$ $f = 10\text{ kHz}$	THD	- -	0.008 0.08	- -	%
Slew Rate ($V_S = \pm 2.5\text{ V}$, $V_O = -2.0\text{ V}$ to 2.0 V , $R_L = 2.0\text{ k}$, $A_V = 1.0$) Positive Slope Negative Slope	SR	1.0 1.0	1.6 1.6	6.0 6.0	V/ μs

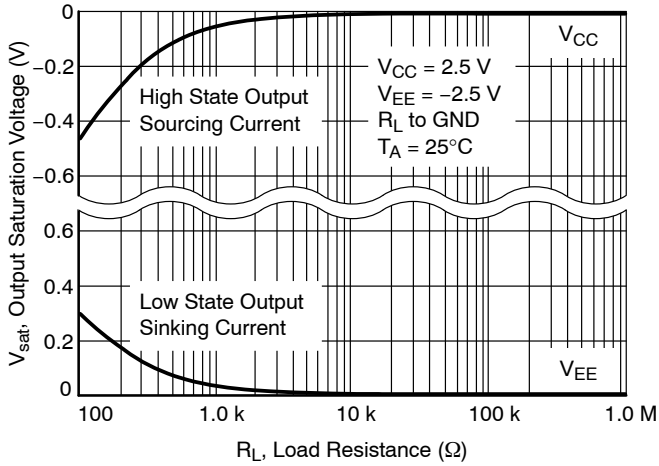

Figure 2. Split Supply Output Saturation vs. Load Resistance

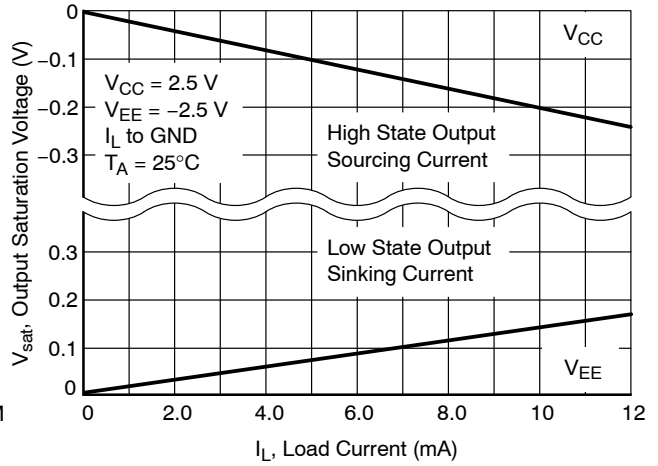

Figure 3. Split Supply Output Saturation vs. Load Current

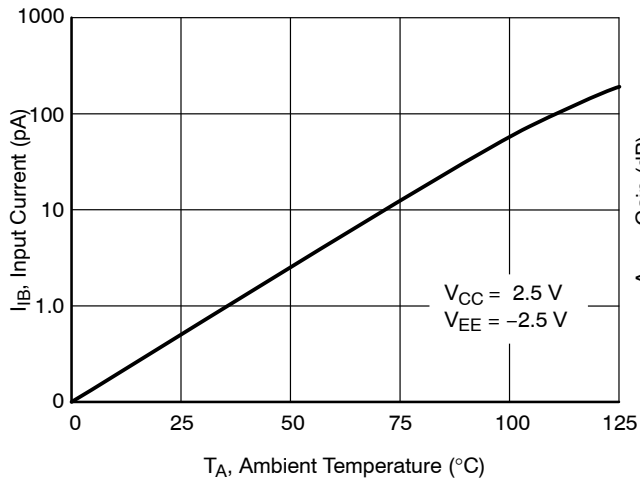

Figure 4. Input Bias Current vs. Temperature

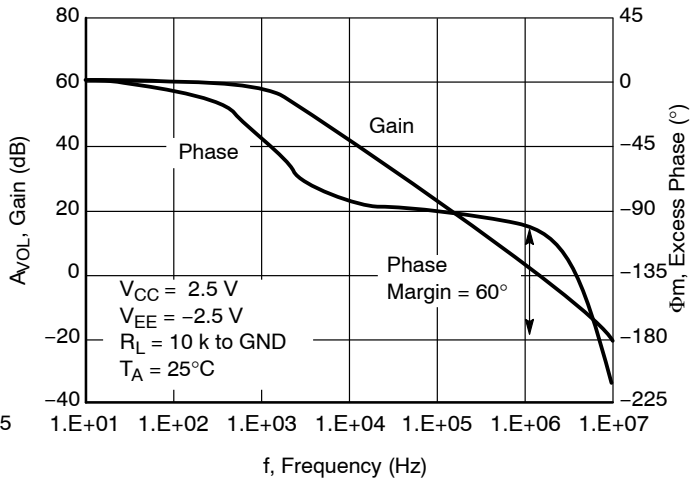

Figure 5. Gain and Phase vs. Frequency

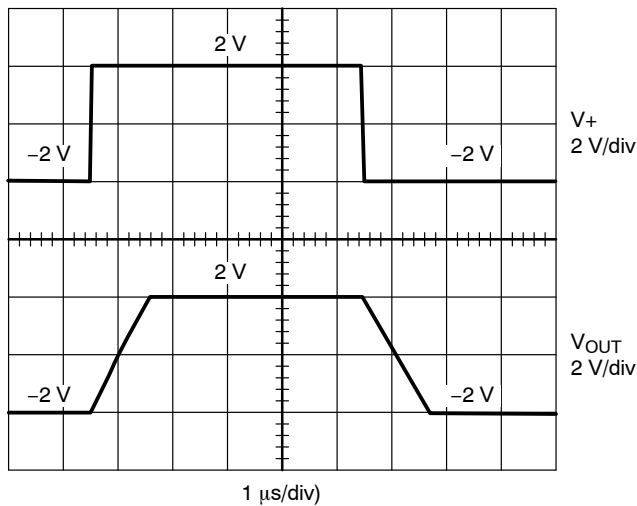

Figure 6. Transient Response

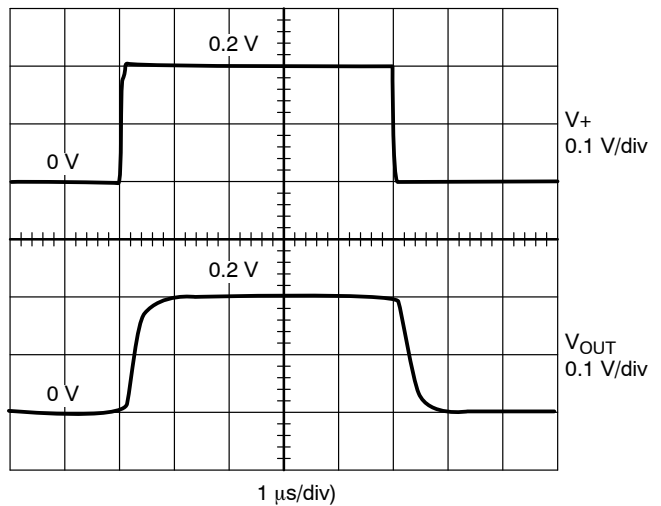

Figure 7. Slew Rate

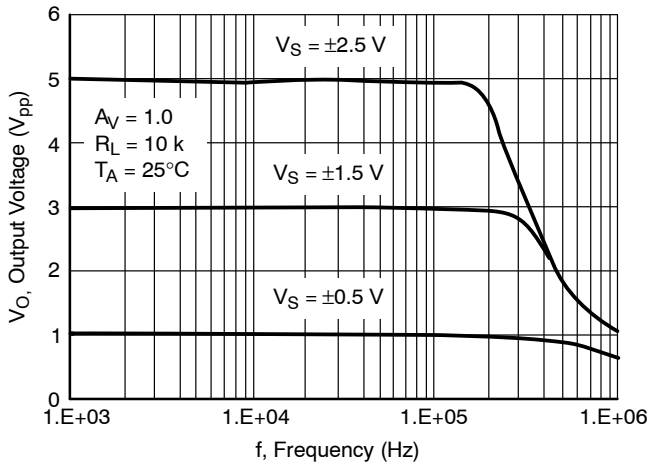

Figure 8. Output Voltage vs. Frequency

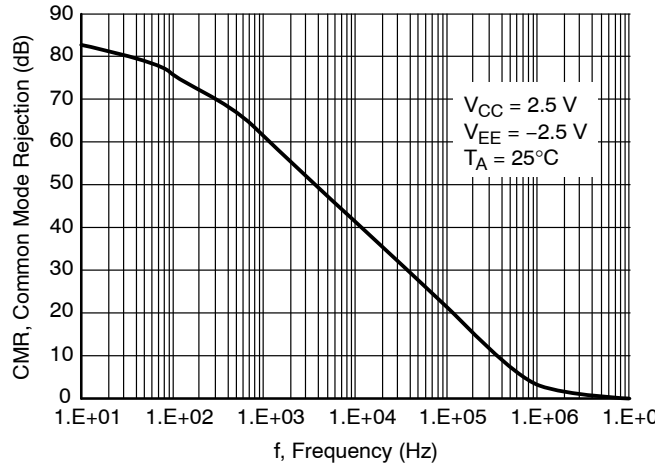

Figure 9. Common Mode Rejection vs. Frequency

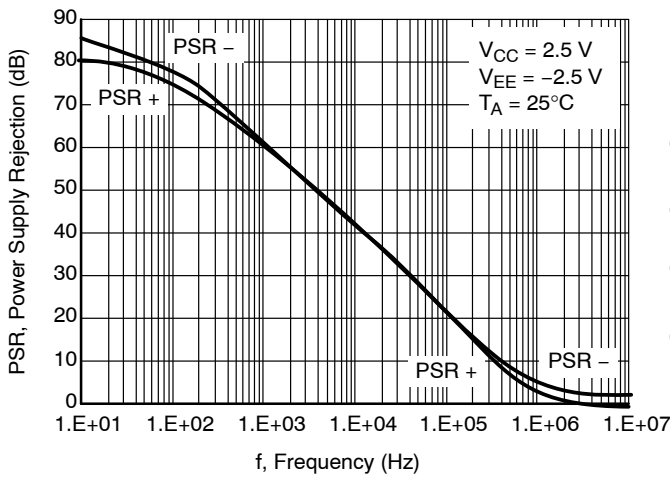

Figure 10. Power Supply Rejection vs. Frequency

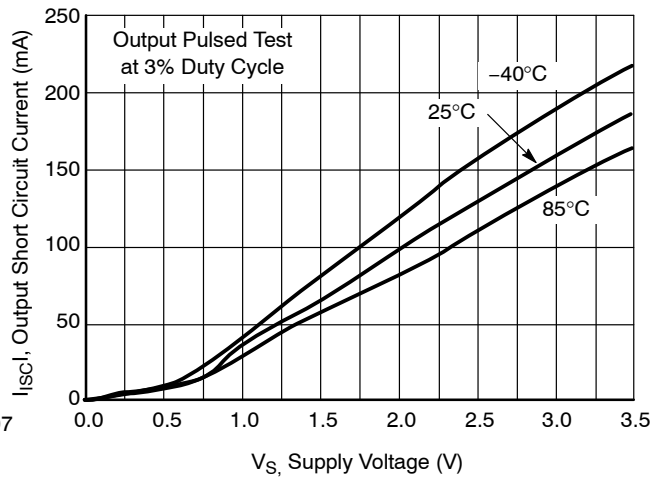

Figure 11. Output Short Circuit Sinking Current vs. Supply Voltage

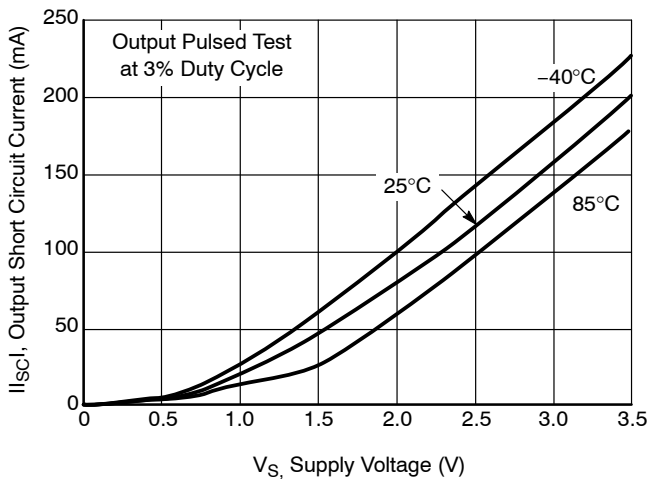

Figure 12. Output Short Circuit Sourcing Current vs. Supply Voltage

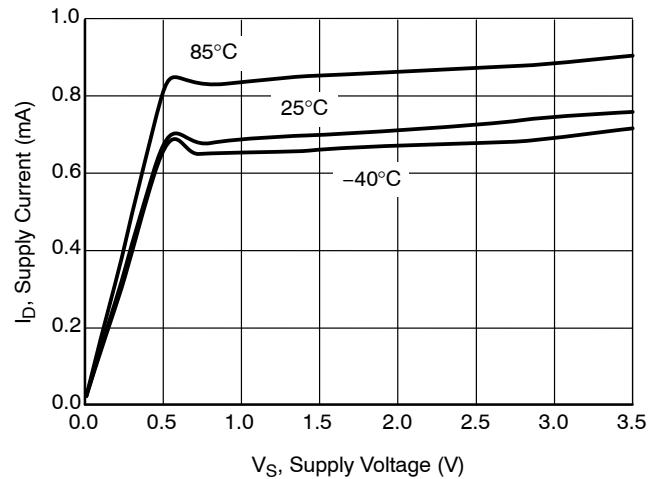

Figure 13. Supply Current vs. Supply Voltage

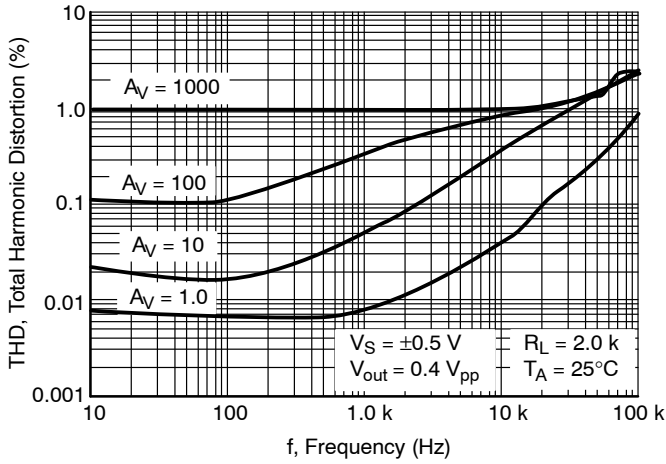

Figure 14. Total Harmonic Distortion vs. Frequency with 1.0 V Supply

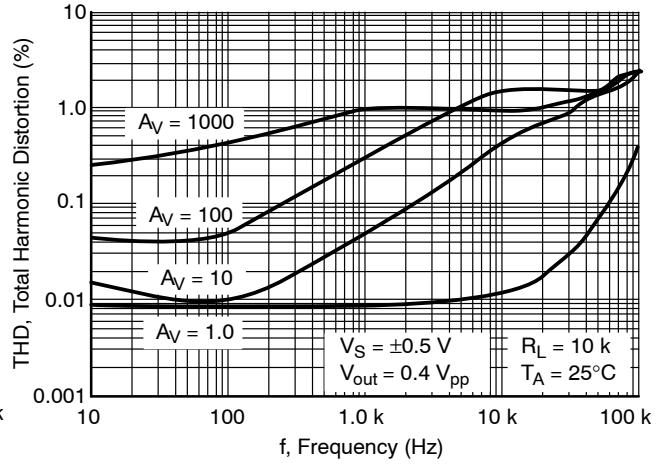

Figure 15. Total Harmonic Distortion vs. Frequency with 1.0 V Supply

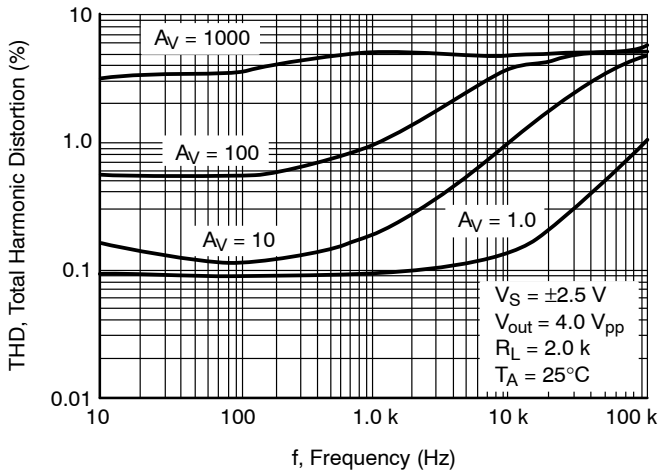

Figure 16. Total Harmonic Distortion vs. Frequency with 5.0 V Supply

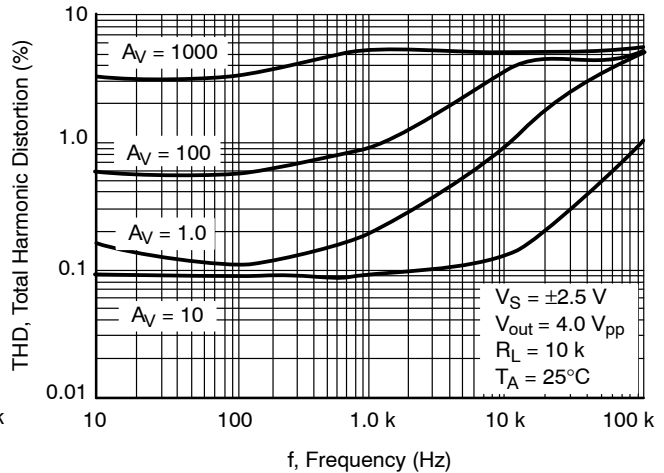

Figure 17. Total Harmonic Distortion vs. Frequency with 5.0 V Supply

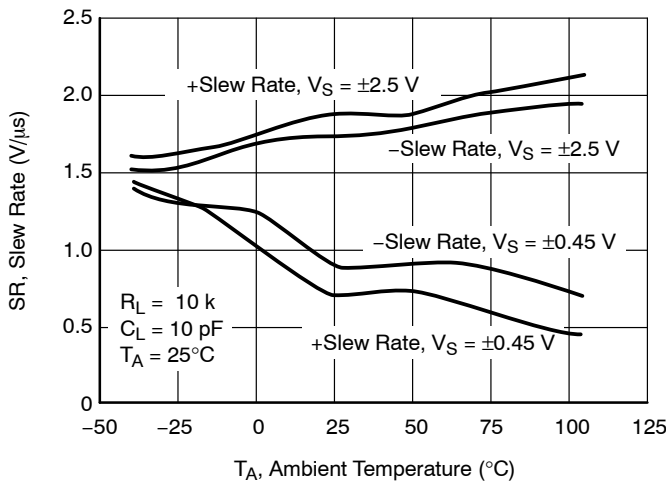

Figure 18. Slew Rate vs. Temperature

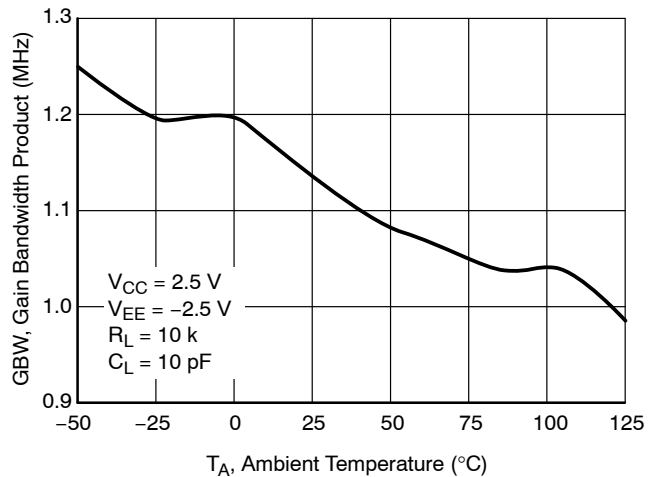

Figure 19. Gain Bandwidth Product vs. Temperature

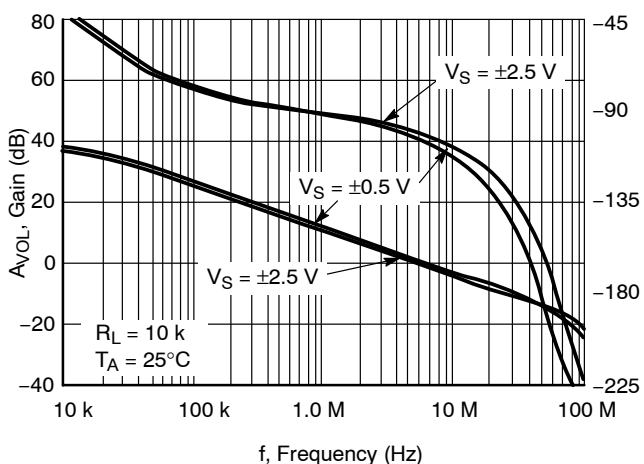

Figure 20. Voltage Gain and Phase vs. Frequency

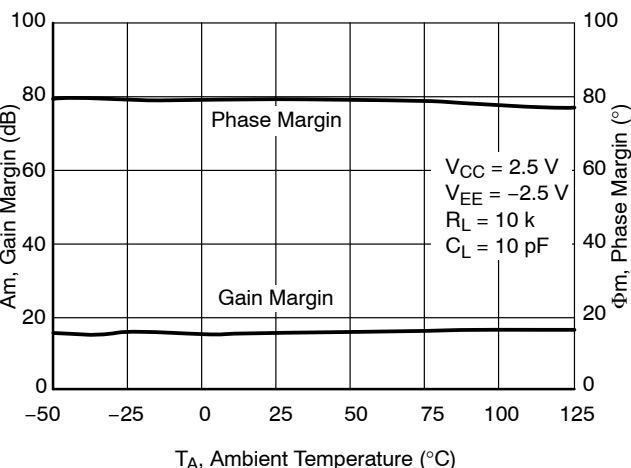

Figure 21. Gain and Phase Margin vs. Temperature

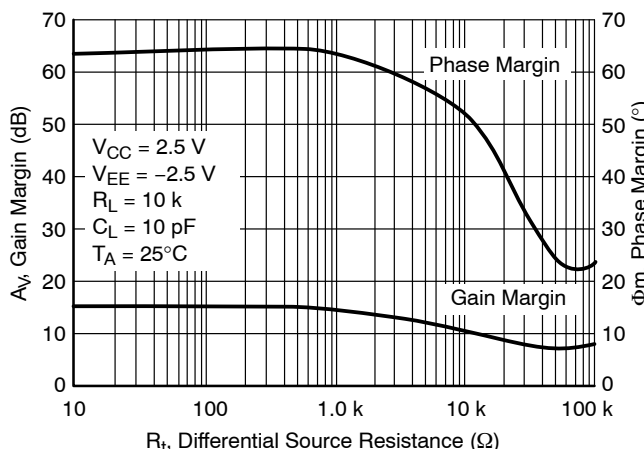

Figure 22. Gain and Phase Margin vs. Differential Source Resistance

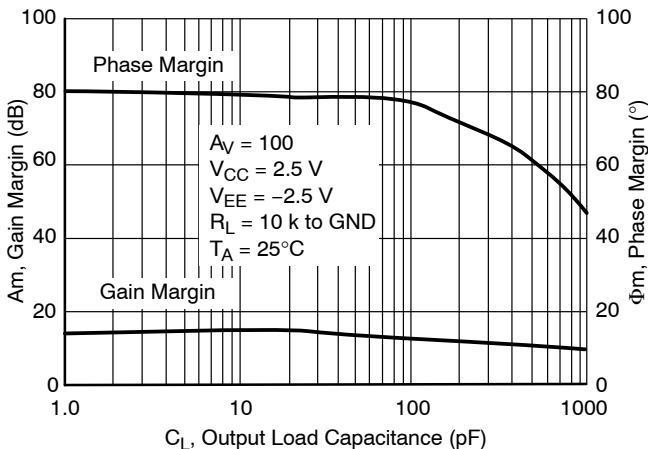

Figure 23. Gain and Phase Margin vs. Output Load Capacitance

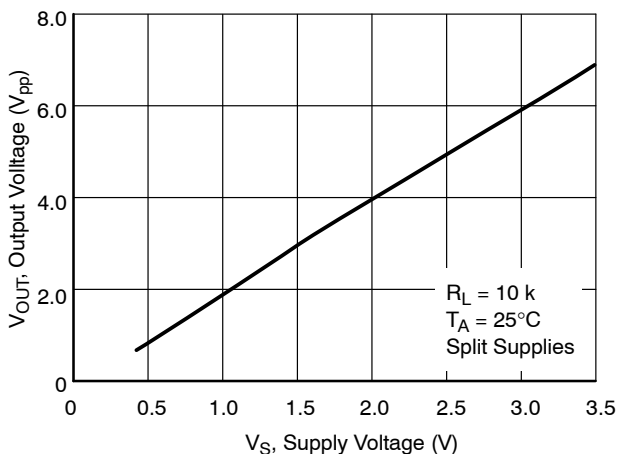

Figure 24. Output Voltage Swing vs. Supply Voltage

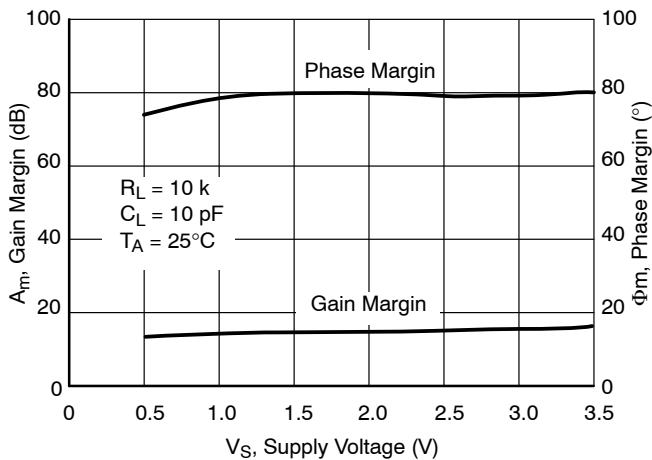

Figure 25. Gain and Phase Margin vs. Supply Voltage

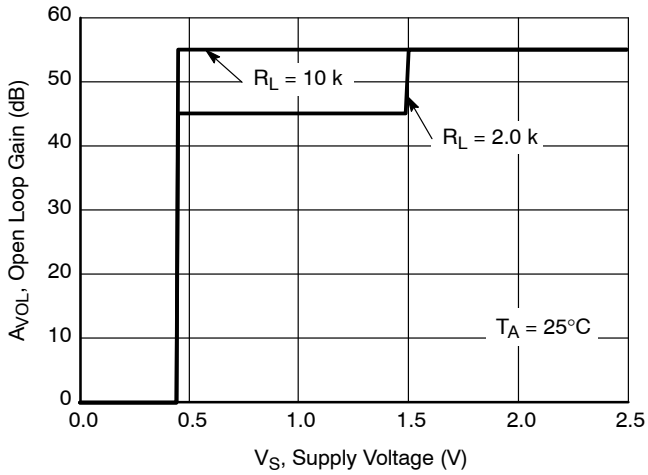

Figure 26. Open Loop Voltage Gain vs. Supply Voltage

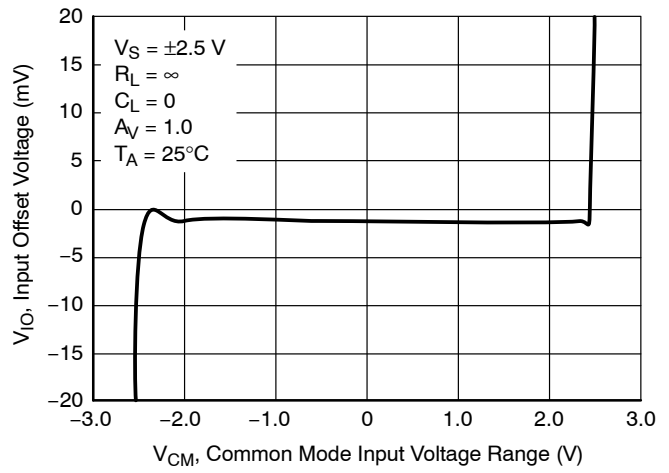

Figure 27. Input Offset Voltage vs. Common Mode Input Voltage Range $V_S = \pm 2.5$ V

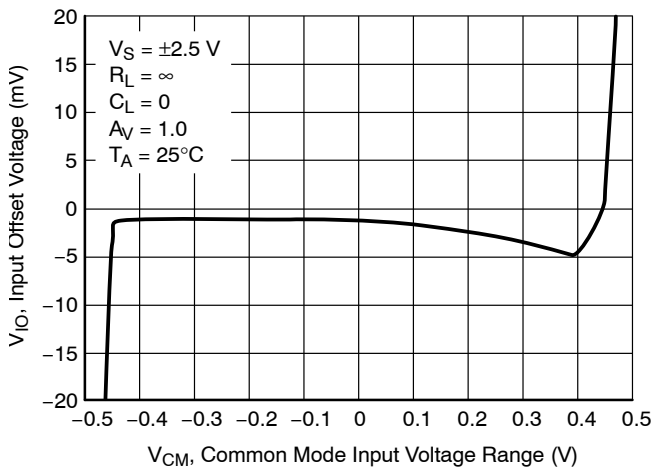

Figure 28. Input Offset Voltage vs. Common Mode Input Voltage Range, $V_S = \pm 0.45$ V

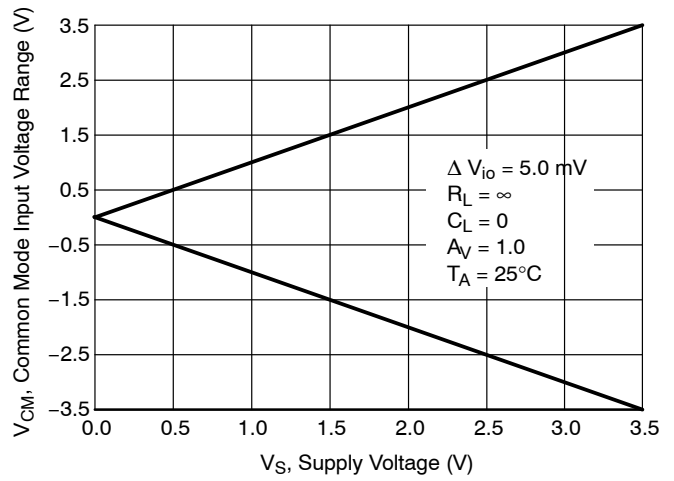

Figure 29. Common-Mode Input Voltage Range vs. Power Supply Voltage

APPLICATION INFORMATION AND OPERATING DESCRIPTION

GENERAL INFORMATION

The NCS2001 is an industry first rail-to-rail input, rail-to-rail output amplifier that features guaranteed sub-one voltage operation. This unique feature set is achieved with the use of a modified analog CMOS process that allows the implementation of depletion MOSFET devices. The amplifier has a 1.0 MHz gain bandwidth product, 2.2 V/ μ s slew rate and is operational over a power supply range less than 0.9 V to as high as 7.0 V.

Inputs

The input topology chosen for this device series is unconventional when compared to most low voltage operational amplifiers. It consists of an N-Channel depletion mode differential transistor pair that drives a folded cascade stage and current mirror. This configuration extends the input common mode voltage range to encompass the V_{EE} and V_{CC} power supply rails, even when powered from a combined total of less than 0.9 V. Figures 27 and 28 show the input common mode voltage range versus power supply voltage.

The differential input stage is laser trimmed in order to minimize offset voltage. The N-Channel depletion mode MOSFET input stage exhibits an extremely low input bias current of less than 10 pA. The input bias current versus temperature is shown in Figure 4. Either one or both inputs can be biased as low as V_{EE} minus 300 mV to as high as 7.0 V without causing damage to the device. If the input common mode voltage range is exceeded, the output will not display a phase reversal. If the maximum input positive or negative voltage ratings are to be exceeded, a series resistor must be used to limit the input current to less than 2.0 mA.

The ultra low input bias current of the NCS2001 allows the use of extremely high value source and feedback resistor without reducing the amplifier's gain accuracy. These high value resistors, in conjunction with the device input and printed circuit board parasitic capacitances C_{in} , will add an additional pole to the single pole amplifier in Figure 30. If low enough in frequency, this additional pole can reduce the phase margin and significantly increase the output settling time. The effects of C_{in} , can be canceled by placing a zero into the feedback loop. This is accomplished with the addition of capacitor C_{fb} . An approximate value for C_{fb} can be calculated by:

$$C_{fb} = \frac{R_{in} \times C_{in}}{R_{fb}}$$

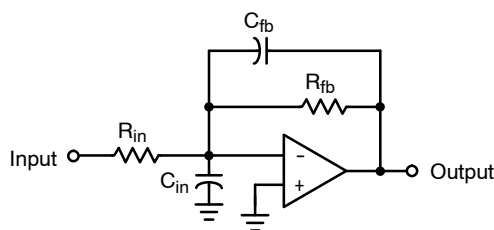

C_{in} = Input and printed circuit board capacitance

Figure 30. Input Capacitance Pole Cancellation

Output

The output stage consists of complementary P and N-Channel devices connected to provide rail-to-rail output drive. With a 2.0 k load, the output can swing within 50 mV of either rail. It is also capable of supplying over 75 mA when powered from 5.0 V and 1.0 mA when powered from 0.9 V.

When connected as a unity gain follower, the NCS2001 can directly drive capacitive loads in excess of 820 pF at room temperature without oscillating but with significantly reduced phase margin. The unity gain follower configuration exhibits the highest bandwidth and is most prone to oscillations when driving a high value capacitive load. The capacitive load in combination with the amplifier's output impedance, creates a phase lag that can result in an under-damped pulse response or a continuous oscillation. Figure 32 shows the effect of driving a large capacitive load in a voltage follower type of setup. When driving capacitive loads exceeding 820 pF, it is recommended to place a low value isolation resistor between the output of the op amp and the load, as shown in Figure 31. The series resistor isolates the capacitive load from the output and enhances the phase margin. Refer to Figure 33. Larger values of R will result in a cleaner output waveform but excessively large values will degrade the large signal rise and fall time and reduce the output amplitude. Depending upon the capacitor characteristics, the isolation resistor value will typically be between 50 to 500 Ω . The output drive capability for resistive and capacitive loads is shown in Figures 2, 3, and 23.

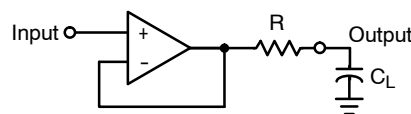

Isolation resistor R = 50 to 500

Figure 31. Capacitance Load Isolation

Note that the lowest phase margin is observed at cold temperature and low supply voltage.

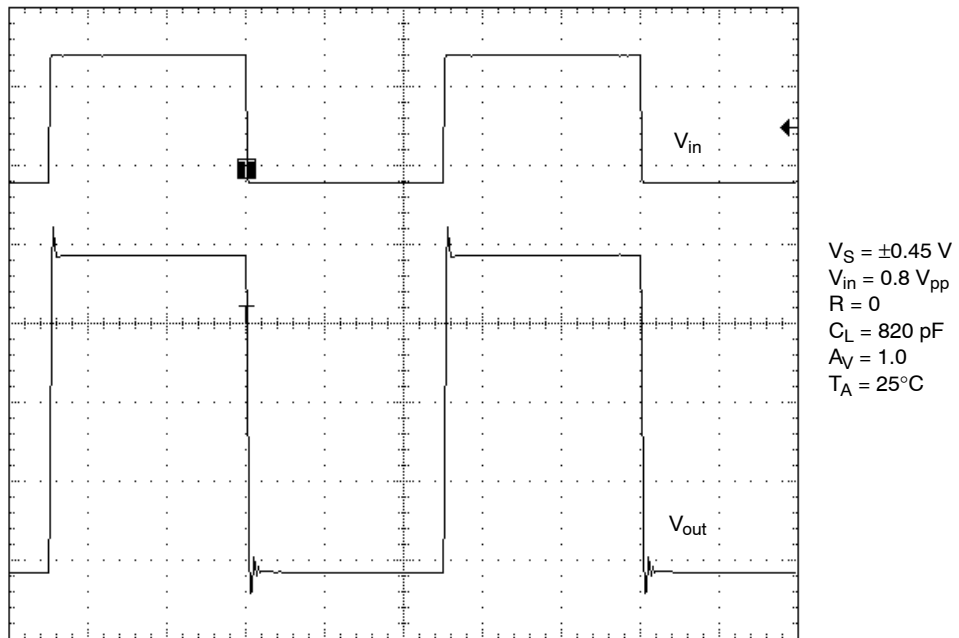

Figure 32. Small Signal Transient Response with Large Capacitive Load

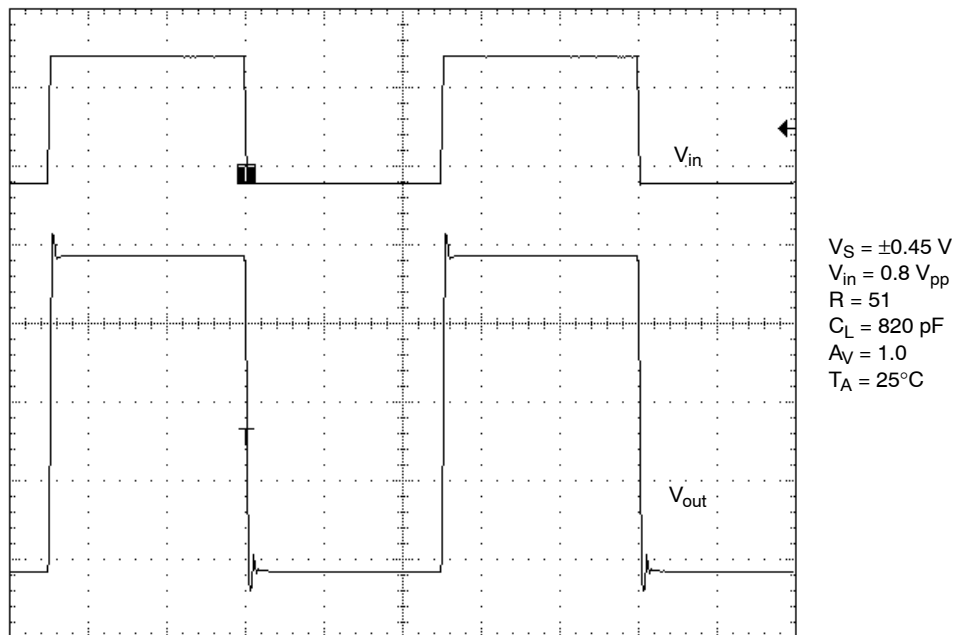

Figure 33. Small Signal Transient Response with Large Capacitive Load and Isolation Resistor

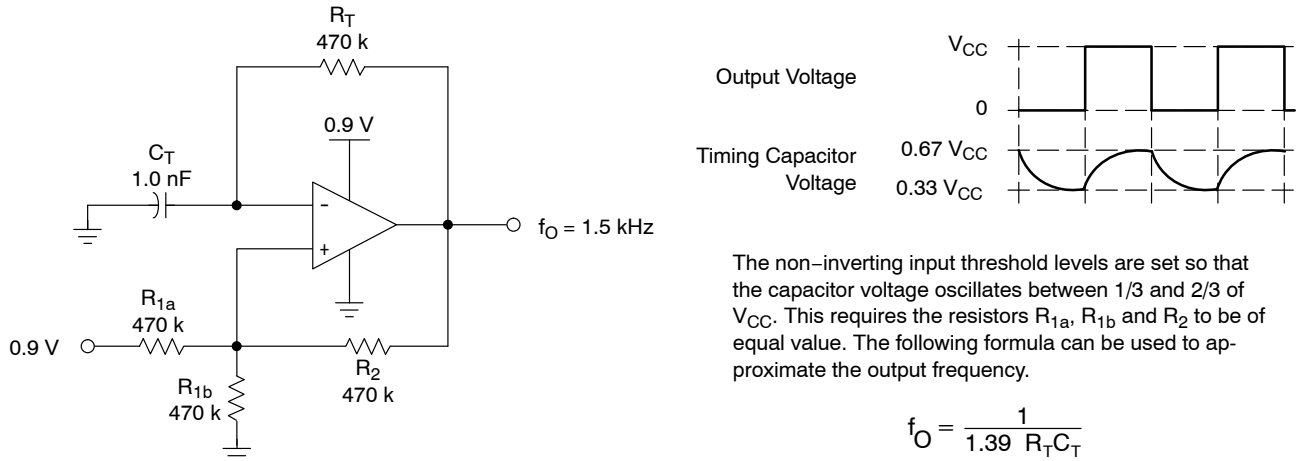

Figure 34. 0.9 V Square Wave Oscillator

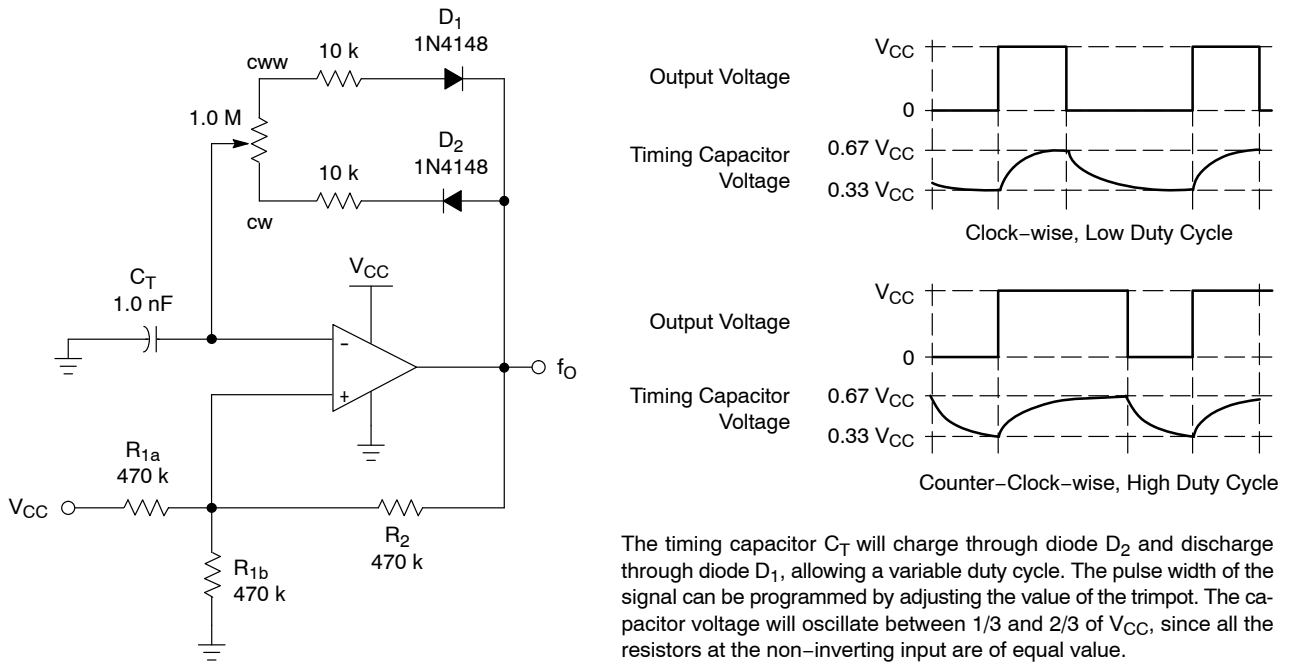

Figure 35. Variable Duty Cycle Pulse Generator

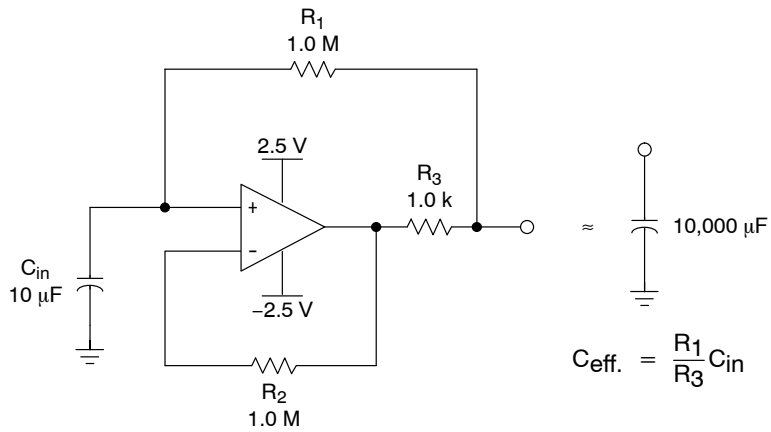

Figure 36. Positive Capacitance Multiplier

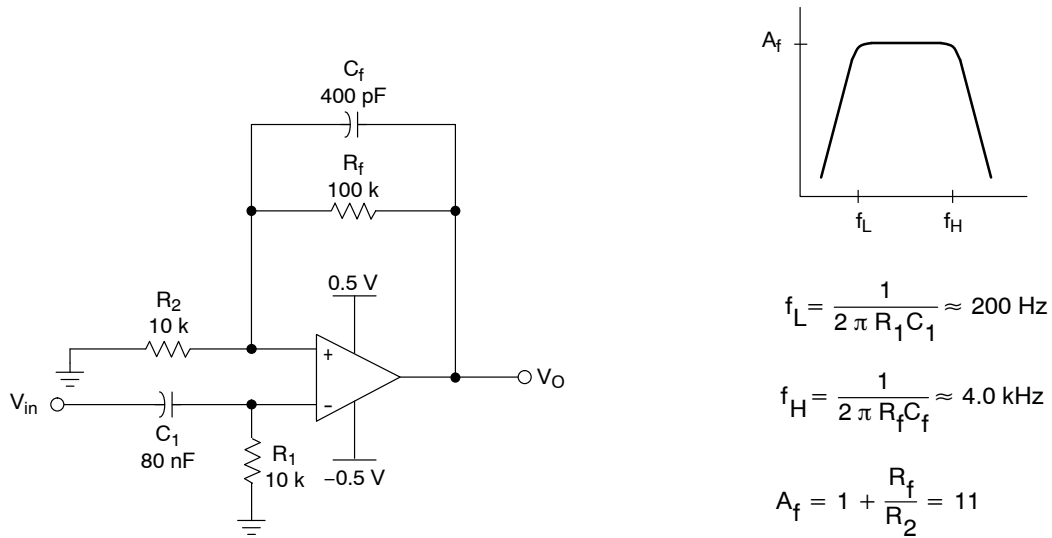

Figure 37. 1.0 V Voiceband Filter

NCS2001, NCV2001

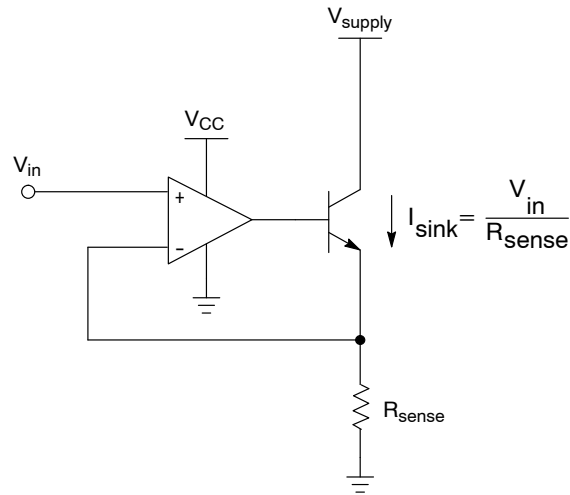
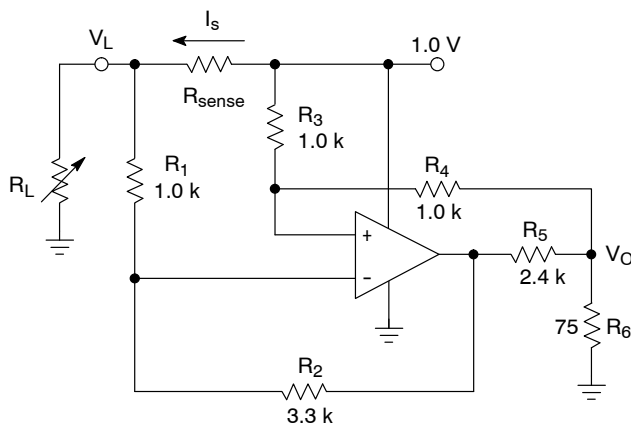

Figure 38. High Compliance Current Sink



I_s	V_O
435 mA	34.7 mV
212 mA	36.9 mV

For best performance, use low tolerance resistors.

Figure 39. High Side Current Sense

ORDERING INFORMATION

Device	Package	Shipping†
NCS2001SN1T1G	SOT23-5 (Pb-Free)	3000 / Tape & 7" Reel
NCS2001SN2T1G	SOT23-5 (Pb-Free)	
NCV2001SN2T1G*	SOT23-5 (Pb-Free)	
NCS2001SQ1T2G	SC70-5 (Pb-Free)	
NCS2001SQ2T2G	SC70-5 (Pb-Free)	
NCV2001SQ2T2G*	SC70-5 (Pb-Free)	

†For information on tape and reel specifications, including part orientation and tape sizes, please refer to our Tape and Reel Packaging Specifications Brochure, BRD8011/D.

*NCV prefix denotes qualification status for automotive applications. Guaranteed by design.

NCS2001, NCV2001

PACKAGE DIMENSIONS

TSOP-5 CASE 483-02 ISSUE H

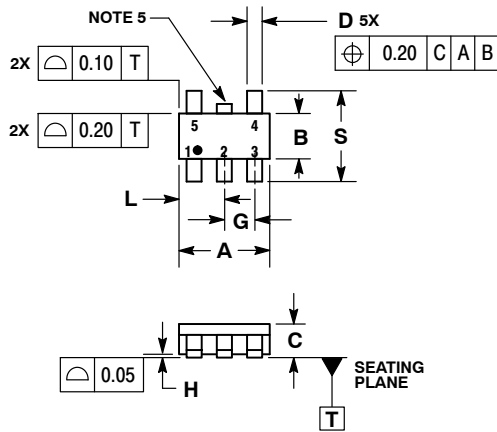

NOTES:

1. DIMENSIONING AND TOLERANCING PER ASME Y14.5M, 1994.
2. CONTROLLING DIMENSION: MILLIMETERS.
3. MAXIMUM LEAD THICKNESS INCLUDES LEAD FINISH THICKNESS. MINIMUM LEAD THICKNESS IS THE MINIMUM THICKNESS OF BASE MATERIAL.
4. DIMENSIONS A AND B DO NOT INCLUDE MOLD FLASH, PROTRUSIONS, OR GATE BURRS.
5. OPTIONAL CONSTRUCTION: AN ADDITIONAL TRIMMED LEAD IS ALLOWED IN THIS LOCATION. TRIMMED LEAD NOT TO EXTEND MORE THAN 0.2 FROM BODY.

DIM	MILLIMETERS	
	MIN	MAX
A	3.00	BSC
B	1.50	BSC
C	0.90	1.10
D	0.25	0.50
G	0.95	BSC
H	0.01	0.10
J	0.10	0.26
K	0.20	0.60
L	1.25	1.55
M	0°	10°
S	2.50	3.00

SOLDERING FOOTPRINT*

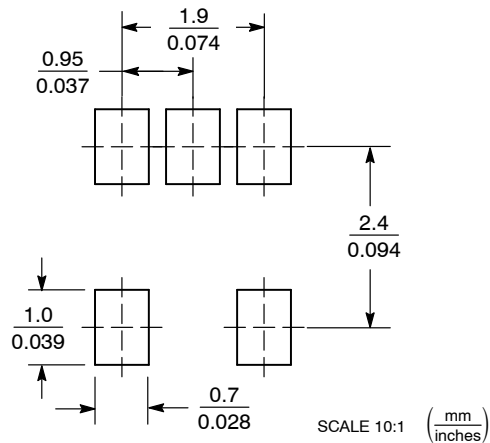

*For additional information on our Pb-Free strategy and soldering details, please download the ON Semiconductor Soldering and Mounting Techniques Reference Manual, SOLDERRM/D.

NCS2001, NCV2001

PACKAGE DIMENSIONS

SC-88A (SC-70-5/SOT-353)
SQ SUFFIX
CASE 419A-02
ISSUE K

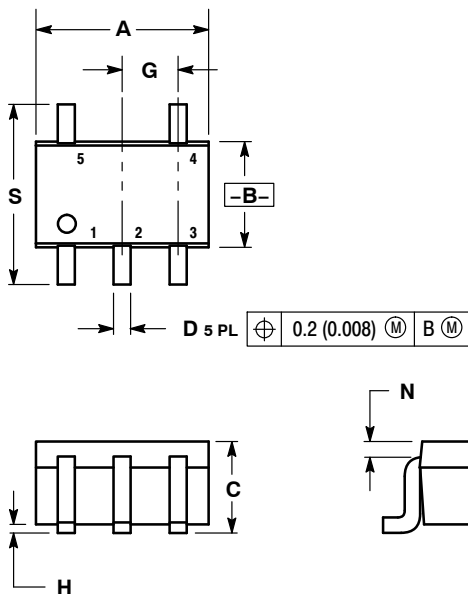

- NOTES:
1. DIMENSIONING AND TOLERANCING PER ANSI Y14.5M, 1982.
 2. CONTROLLING DIMENSION: INCH.
 3. 419A-01 OBSOLETE. NEW STANDARD 419A-02.
 4. DIMENSIONS A AND B DO NOT INCLUDE MOLD FLASH, PROTRUSIONS, OR GATE BURRS.

DIM	INCHES		MILLIMETERS	
	MIN	MAX	MIN	MAX
A	0.071	0.087	1.80	2.20
B	0.045	0.053	1.15	1.35
C	0.031	0.043	0.80	1.10
D	0.004	0.012	0.10	0.30
G	0.026 BSC		0.65 BSC	
H	---	0.004	---	0.10
J	0.004	0.010	0.10	0.25
K	0.004	0.012	0.10	0.30
N	0.008 REF		0.20 REF	
S	0.079	0.087	2.00	2.20

SOLDERING FOOTPRINT*

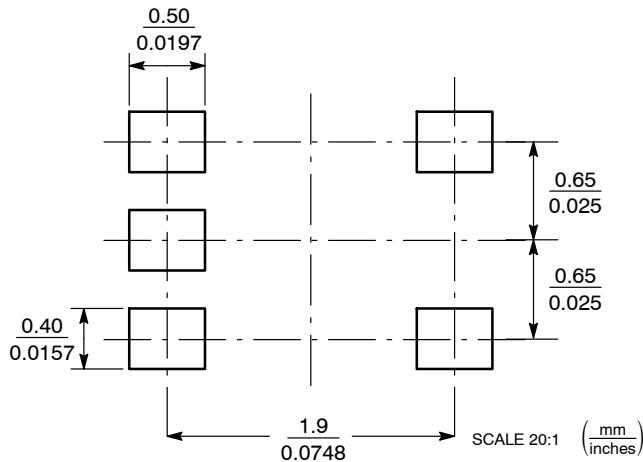

*For additional information on our Pb-Free strategy and soldering details, please download the ON Semiconductor Soldering and Mounting Techniques Reference Manual, SOLDERRM/D.

ON Semiconductor and are registered trademarks of Semiconductor Components Industries, LLC (SCILLC). SCILLC reserves the right to make changes without further notice to any products herein. SCILLC makes no warranty, representation or guarantee regarding the suitability of its products for any particular purpose, nor does SCILLC assume any liability arising out of the application or use of any product or circuit, and specifically disclaims any and all liability, including without limitation special, consequential or incidental damages. "Typical" parameters which may be provided in SCILLC data sheets and/or specifications can and do vary in different applications and actual performance may vary over time. All operating parameters, including "Typicals" must be validated for each customer application by customer's technical experts. SCILLC does not convey any license under its patent rights nor the rights of others. SCILLC products are not designed, intended, or authorized for use as components in systems intended for surgical implant into the body, or other applications intended to support or sustain life, or for any other application in which the failure of the SCILLC product could create a situation where personal injury or death may occur. Should Buyer purchase or use SCILLC products for any such unintended or unauthorized application, Buyer shall indemnify and hold SCILLC and its officers, employees, subsidiaries, affiliates, and distributors harmless against all claims, costs, damages, and expenses, and reasonable attorney fees arising out of, directly or indirectly, any claim of personal injury or death associated with such unintended or unauthorized use, even if such claim alleges that SCILLC was negligent regarding the design or manufacture of the part. SCILLC is an Equal Opportunity/Affirmative Action Employer. This literature is subject to all applicable copyright laws and is not for resale in any manner.

PUBLICATION ORDERING INFORMATION

LITERATURE FULFILLMENT:
Literature Distribution Center for ON Semiconductor
P.O. Box 5163, Denver, Colorado 80217 USA
Phone: 303-675-2175 or 800-344-3860 Toll Free USA/Canada
Fax: 303-675-2176 or 800-344-3867 Toll Free USA/Canada
Email: orderlit@onsemi.com

N. American Technical Support: 800-282-9855 Toll Free
USA/Canada
Europe, Middle East and Africa Technical Support:
Phone: 421 33 790 2910
Japan Customer Focus Center
Phone: 81-3-5773-3850

ON Semiconductor Website: www.onsemi.com
Order Literature: <http://www.onsemi.com/orderlit>

For additional information, please contact your local Sales Representative



Компания «ЭлектроПласт» предлагает заключение долгосрочных отношений при поставках импортных электронных компонентов на взаимовыгодных условиях!

Наши преимущества:

- Оперативные поставки широкого спектра электронных компонентов отечественного и импортного производства напрямую от производителей и с крупнейших мировых складов;
- Поставка более 17-ти миллионов наименований электронных компонентов;
- Поставка сложных, дефицитных, либо снятых с производства позиций;
- Оперативные сроки поставки под заказ (от 5 рабочих дней);
- Экспресс доставка в любую точку России;
- Техническая поддержка проекта, помощь в подборе аналогов, поставка прототипов;
- Система менеджмента качества сертифицирована по Международному стандарту ISO 9001;
- Лицензия ФСБ на осуществление работ с использованием сведений, составляющих государственную тайну;
- Поставка специализированных компонентов (Xilinx, Altera, Analog Devices, Intersil, Interpoint, Microsemi, Aeroflex, Peregrine, Syfer, Eurofarad, Texas Instrument, Miteq, Cobham, E2V, MA-COM, Hittite, Mini-Circuits, General Dynamics и др.);

Помимо этого, одним из направлений компании «ЭлектроПласт» является направление «Источники питания». Мы предлагаем Вам помощь Конструкторского отдела:

- Подбор оптимального решения, техническое обоснование при выборе компонента;
- Подбор аналогов;
- Консультации по применению компонента;
- Поставка образцов и прототипов;
- Техническая поддержка проекта;
- Защита от снятия компонента с производства.



Как с нами связаться

Телефон: 8 (812) 309 58 32 (многоканальный)

Факс: 8 (812) 320-02-42

Электронная почта: org@eplast1.ru

Адрес: 198099, г. Санкт-Петербург, ул. Калинина, дом 2, корпус 4, литера А.