

# POWER

## Modular High Power System

Data Sheet

Up to 24000 Watts

**Total Power:** Up to 24 KW  
**Input Voltage:** 180-264 Vac  
 342-528 Vac  
 Single Phase or  
 3-Phase  
**# of Outputs:** Up to 8



### SPECIAL FEATURES

- 5 years manufacturer's warranty
- Multi output intelligent and modular high power system
- Standard 19" rack
- Outputs parallel up to 1600 A
- Outputs series up to 1000 V
- 100% digital control
- Outputs program as voltage or current source
- Versatile input configurable to:
  - Low line 180-264 Vac single phase and 3-phase
  - High line 342-528 Vac 3-phase
- Medical safety approved – NO ISOLATION XFMR NEEDED
- Flexible control interfaces (Note 1)
- Air cooled
- Semi F47 compliance
- Field upgradeable firmware
- Programmable slew rate
- Fast current slew rate up to 200 Hz
- Active power factor correction
- User defined command profiles

### SAFETY

- UL 60950-1 2<sup>nd</sup> Edition; EN60950-1; IEC60950-1/EN60950
- CSA C22.2 No. 60950-1-07, 2<sup>nd</sup> Edition
- EN60601-1; IEC60601-1; IEC60601
- UL 60601-1 1st Edition; ANSI/AAMI ES60601-1 (2005 + C1:09 + A2:10) 3<sup>rd</sup> Ed
- CAN/CSA-C22.2 No. 60601-1 (2008)
- CB Certificate and Report
- CE (LVD+RoHS), EN60950-1

### iHP24 Electrical Specifications

| Input Parameter              | 19" Rack 24 KW strapped as 3-phase 380/480 Vac Nominal (iHP24H3A/L)                                                                                    | 19" Rack 24 KW strapped as 3-phase 208/240 Vac Nominal (iHP24L3A/L) |
|------------------------------|--------------------------------------------------------------------------------------------------------------------------------------------------------|---------------------------------------------------------------------|
| Input range                  | 342 Vac to 528 Vac<br>(Nominal rating 380/480 Vac)                                                                                                     | 187.5 Vac to 264 Vac<br>(Nominal rating 208/240 Vac)                |
| Number of phases             | 3-phase (Wye or Delta) 4 wire total (3-phase and 1 protective earth ground)                                                                            |                                                                     |
| Frequency                    | 47-63 Hz                                                                                                                                               |                                                                     |
| Phase detection              | Loss of phase will inhibit unit off.<br>Housekeeping/comms must continue with phase loss.                                                              |                                                                     |
| Max current/phase            | 51 A @ 342 Vac<br>40 A @ 432 Vac                                                                                                                       | 84 A @ 187.5 Vac                                                    |
| Undervoltage detection       | Nominal input locked on at turn-on. Undervoltage shutdown at 15% below nominal.<br>Turn-on at 12% below nominal. Not to interfere with SEMI F47 specs. |                                                                     |
| Current inrush               | 2.5 x Max input current                                                                                                                                |                                                                     |
| Power factor                 | > 0.98 @ full load and nominal line                                                                                                                    |                                                                     |
| Harmonic distortion          | THD < 13%, PWHD < 22% (refer to EN 61000-3-12)                                                                                                         |                                                                     |
| Line interruption            | Designed to meet SEMI F47-0706, 53, 58, S14 at nominal input voltages                                                                                  |                                                                     |
| Input leakage current        | < 2.5 mA (Note for fixed condition 3rd edition leakage = 5 mA)                                                                                         |                                                                     |
| Power switch                 | Front panel power switch provided                                                                                                                      |                                                                     |
| Input protection             | Internal fuse (not user serviceable)                                                                                                                   |                                                                     |
| Input overvoltage protection | Up to 115% of nominal input shall not damage unit                                                                                                      |                                                                     |
| Phase imbalance              | ≤ 5%                                                                                                                                                   |                                                                     |
| Rack parallel                | Up to 6 racks (144 KW)                                                                                                                                 |                                                                     |
| Efficiency                   | > 90% @ 3P 380 Vac full load<br>> 91% @ 3P 480 Vac full load                                                                                           | > 91% @ 3P 240 Vac full load<br>> 90% @ 3P 208 Vac 3P full load     |
| Standby voltage              | 5 V                                                                                                                                                    |                                                                     |
| Standby regulation           | 4.75 - 5.25 V                                                                                                                                          |                                                                     |
| Standby max current          | 1 A                                                                                                                                                    |                                                                     |

Note 1: Analog 0-5 V or 0-10 V separate for voltage or current; Digital Ethernet UDP, RS485, CAN or Ethernet TC/IP with PowerPro Connect Module option. Command protocol is patterned to PMBus specification using a proprietary transaction protocol.

## iHP12 Electrical Specifications

| Input Parameter              | 19" Rack 12 KW strapped as 1-phase 200/220/230/240 Vac Nominal (iHP12L1A)                                                                           | Type: 19" Rack 12 KW strapped as 3-phase 200/208/240 Vac Nominal (iHP12L3A)               | Type: 19" Rack 12 KW strapped as 3-phase 380/480 Vac Nominal (iHP12H3A) |
|------------------------------|-----------------------------------------------------------------------------------------------------------------------------------------------------|-------------------------------------------------------------------------------------------|-------------------------------------------------------------------------|
| Input range                  | 180 Vac to 264 Vac<br>(Nominal rating 200/220/230/240 Vac)                                                                                          | 180 Vac to 264 Vac<br>(Nominal rating 200/208/240 Vac)                                    | 342 Vac to 528 Vac<br>(Nominal rating 380/480 Vac)                      |
| Number of phases             | 1-phase 3-wire total (2-phase and 1 protective earth ground)                                                                                        | 3-phase (Wye or Delta) 4-wire total (3-phase and 1 protective earth ground)               |                                                                         |
| Frequency                    | 47-63 Hz                                                                                                                                            |                                                                                           |                                                                         |
| Phase detection              | NA                                                                                                                                                  | Loss of phase will inhibit unit off.<br>Housekeeping/comms must continue with phase loss. |                                                                         |
| Max current/phase            | 75 A @ 180 Vac                                                                                                                                      | 44 A @ 180 Vac                                                                            | 23 A @ 342 Vac<br>19 A @ 432 Vac                                        |
| Undervoltage detection       | Nominal input locked on at turn-on. Undervoltage shutdown at 15% below nominal. Turn-on at 12% below nominal. Not to interfere with SEMI F47 specs. |                                                                                           |                                                                         |
| Current inrush               | 2.5 x Max input current                                                                                                                             |                                                                                           |                                                                         |
| Power factor                 | > 0.99 @ full load and nominal line                                                                                                                 | > 0.98 @ full load and nominal line                                                       |                                                                         |
| Harmonic distortion          | THD < 3.5%, PWHD < 22% (refer to EN 61000-3-12)                                                                                                     |                                                                                           |                                                                         |
| Line interruption            | Designed to meet SEMI F47-0706, 53, 58, S14 at nominal input voltages                                                                               |                                                                                           |                                                                         |
| Input leakage current        | < 1.25 mA                                                                                                                                           |                                                                                           | < 2.5 mA                                                                |
| Power switch                 | Front panel power switch provided                                                                                                                   |                                                                                           |                                                                         |
| Input protection             | Internal fuse (not user serviceable)                                                                                                                |                                                                                           |                                                                         |
| Input overvoltage protection | Up to 115% of nominal input shall not damage unit                                                                                                   |                                                                                           |                                                                         |
| Phase imbalance              | NA                                                                                                                                                  | ≤ 5%                                                                                      | ≤ 5%                                                                    |
| Rack parallel                | Up to 6 racks (72 KW)                                                                                                                               |                                                                                           |                                                                         |
| Efficiency                   | > 91% @ 1P 240 Vac full load<br>> 90% @ 1P 208 Vac/200 Vac full load                                                                                | > 91% @ 3P 240 Vac full load<br>> 90% @ 3P 208 Vac/200 Vac full load                      | > 90% @ 3P 380 Vac full load<br>> 91% @ 3P 480 Vac full load            |
| Standby voltage              | 5 V                                                                                                                                                 |                                                                                           |                                                                         |
| Standby regulation           | 4.75 - 5.25 V                                                                                                                                       |                                                                                           |                                                                         |
| Standby max current          | 1 A                                                                                                                                                 |                                                                                           |                                                                         |

## EMC/Immunity

| Parameter                                                       | All Models (Unless otherwise specified) |
|-----------------------------------------------------------------|-----------------------------------------|
| <b>ESD</b>                                                      | EN61000-4-2 (IEC1000-4-2)               |
| <b>Fast Transients</b>                                          | EN61000-4-4 (IEC1000-4-4)               |
| <b>Surge Immunity</b>                                           | EN61000-4-5 (IEC1000-4-5)               |
| <b>Conducted Immunity</b>                                       | EN61000-4-6 (IEC1000-4-6)               |
| <b>Radiated Immunity</b>                                        | EN61000-4-3 (IEC1000-4-3)               |
| <b>Power Frequency Magnetic Field</b>                           | EN61000-4-8                             |
| <b>Voltage Dips, Short Interruptions and Voltage Variations</b> | EN 61000-4-34                           |
| <b>Conducted Emission</b>                                       | EN55011, FCC CFR 47, Part 15, Subpart B |
| <b>Radiated Emission</b>                                        | EN55011, FCC CFR 47, Part 15, Subpart B |

## Electromagnetic Compatibility/Input Transient

| Category                                 | Standard                       | Frequency                                                                                                                                                 | Level/Limits                                                              | PSU Performance Criteria <sup>1</sup>  |
|------------------------------------------|--------------------------------|-----------------------------------------------------------------------------------------------------------------------------------------------------------|---------------------------------------------------------------------------|----------------------------------------|
| <b>Radiated Emissions<sup>3</sup></b>    | EN 55011/CISPR11               | 30 M - 1 GHz                                                                                                                                              | Class A                                                                   | 5 dB Margin                            |
|                                          | FCC CFR 47, Part 15, Subpart B | 30 M - 1 GHz<br>>1 GHz (see standard)                                                                                                                     | Class A                                                                   | 5 dB Margin                            |
| <b>Conducted Emissions<sup>3</sup></b>   | EN 55011/CISPR11               | 150 k - 30 MHz                                                                                                                                            | Class A                                                                   | 5 dB Margin                            |
| <b>Power Line Harmonics<sup>2</sup></b>  | EN 61000-3-12                  | See standard                                                                                                                                              | See standard                                                              |                                        |
| <b>Voltage Fluctuations<sup>2</sup></b>  | EN 61000-3-11                  | See standard                                                                                                                                              | See standard                                                              |                                        |
| <b>Radiated Immunity</b>                 | EN 61000-4-3                   | 80 M - 2 GHz                                                                                                                                              | 10 V/meter                                                                | A                                      |
| <b>ESD</b>                               | EN 61000-4-2                   |                                                                                                                                                           | 8 KV contact, 15 KV Air                                                   | A                                      |
| <b>Electrical Fast Transient</b>         | EN 61000-4-4                   |                                                                                                                                                           | +/- 4 KV                                                                  | A                                      |
| <b>Surge AC</b>                          | EN 61000-4-5                   |                                                                                                                                                           | 2 KV DM, 2 KV CM                                                          | A                                      |
|                                          | IEEE C62.41                    |                                                                                                                                                           | 2 KV DM, 2 KV CM<br>6 KV, CM & DM                                         | A<br>Fail Safe                         |
| <b>Conducted Susceptibility</b>          | EN 61000-4-6                   | 150 KHz – 80 MHz                                                                                                                                          | 10 Vrms                                                                   | A                                      |
| <b>Voltage Dips and Sags<sup>2</sup></b> | EN 61000-4-34<br>SEMI F47      | >95% reduction for<br>>30% reduction for<br>>95% reduction for<br>20% reduction for<br>30% reduction for<br>50% reduction for<br><b>60% reduction for</b> | 10 mS<br>500 mS<br>500 mS<br>5000 mS<br>500 mS<br>200 mS<br><b>200 mS</b> | A<br>A<br>C<br>A<br>A<br>A<br><b>B</b> |

Notes:

<sup>1</sup> Performance Criteria as defined by EN 300 386 V1.3.3<sup>2</sup> Applies to AC power supplies only.<sup>3</sup> Conducted and radiated emissions are measured using a typical set-up. In an actual end system, additional EMI filters may be required.

## OUTPUT – General Specs

| Parameter                      |                                                                                                                                                                     |               |                |                |             |             |             |
|--------------------------------|---------------------------------------------------------------------------------------------------------------------------------------------------------------------|---------------|----------------|----------------|-------------|-------------|-------------|
| MODULE CODE                    | SL                                                                                                                                                                  | SQ            | SW             | S8             | S1          | SA          | S2          |
| <b># Outputs</b>               | 1                                                                                                                                                                   | 1             | 1              | 1              | 1           | 1           | 1           |
| <b>Nominal O/P (V)</b>         | 12.0 V                                                                                                                                                              | 24.0 V        | 48.0 V         | 80.0 V         | 125.0 V     | 200.0 V     | 250.0 V     |
| <b>Max Power (W)</b>           | 2400 W                                                                                                                                                              | 2880 W        | 3000 W         | 3000 W         | 3000 W      | 3000 W      | 3000 W      |
| <b>O/P Current Range (A)</b>   | 0.0 A - 200 A                                                                                                                                                       | 0.0 A - 120 A | 0.0 A - 62.5 A | 0.0 A - 37.5 A | 0.0 A -24 A | 0.0 A -15 A | 0.0 A -12 A |
| <b>Power Density (W/cu-in)</b> | 32.5                                                                                                                                                                | 39.0          | 40.6           | 40.6           | 40.6        | 40.6        | 40.6        |
| <b>Efficiency (%)</b>          | 93.5                                                                                                                                                                | 93.5          | 93.5           | 93.5           | 93.5        | 93.5        | 93.5        |
| <b>Module Input Voltage</b>    | 400 V                                                                                                                                                               |               |                |                |             |             |             |
| <b>Module Operating Temp</b>   | -0 °C to +65 °C; Baseplate Temp TBD                                                                                                                                 |               |                |                |             |             |             |
| <b>Series Operation</b>        | 250 V modules can be connected in series up to 800 V for Medical and 1000 V for ITE                                                                                 |               |                |                |             |             |             |
| <b>Parallel Operation</b>      | Up to 8 modules can be paralleled in 1 rack, with up to 6 racks connected in parallel.<br>Single Wire Parallel connection will be provided as part of configuration |               |                |                |             |             |             |

## OUTPUT – Module in Voltage Source Mode

| Voltage Source                |                                                                                                      |                |                |                |                  |                  |                  |
|-------------------------------|------------------------------------------------------------------------------------------------------|----------------|----------------|----------------|------------------|------------------|------------------|
| MODULE CODE                   | SL                                                                                                   | SQ             | SW             | S8             | S1               | SA               | S2               |
| Nominal Output (V)            | 12                                                                                                   | 24             | 48             | 80             | 125              | 200              | 250              |
| Setting Range (V)             | 0.6 V - 14.4 V                                                                                       | 1.2 V - 28.8 V | 2.4 V - 57.6 V | 4.0 V - 96.0 V | 6.25 V - 150.0 V | 10.0 V - 240.0 V | 12.5 V - 300.0 V |
| Low Frequency RMS Ripple (mV) | 24                                                                                                   | 48             | 96             | 160            | 250              | 400              | 500              |
| Line Regulation (mV)          | 12                                                                                                   | 24             | 48             | 80             | 125              | 200              | 250              |
| Load Regulation (mV)          | 24                                                                                                   | 48             | 96             | 160            | 250              | 400              | 500              |
| P-P Ripple (mV)               | 60                                                                                                   | 120            | 240            | 400            | 625              | 1000             | 1250             |
| Drift (Temp Stability)        | ±0.05% of I <sub>out</sub> Rated over 8 hours, after 30 minute warm up, constant Line, Load and Temp |                |                |                |                  |                  |                  |
| Temp Coefficient (PPM/°C)     | 200                                                                                                  |                |                |                |                  |                  |                  |
| Pgm Accuracy (mV)             | Digital: 0.1% of Nominal Output Voltage; Analog: 1.0% of Nominal Output Voltage                      |                |                |                |                  |                  |                  |
| Pgm Resolution (mV)           | SL=TBD; SQ=1; SW=2; S8=8; S1=6; S2=21                                                                |                |                |                |                  |                  |                  |
| Meas Accuracy (mV)            | 0.2% + 0.2% of Nominal Output Voltage                                                                |                |                |                |                  |                  |                  |
| Meas Resolution               | SL=TBD; SQ=1; SW=2; S8=8; S1=6; S2=21                                                                |                |                |                |                  |                  |                  |
| Transient Response            | Max 5.0% deviation from current set point must recover within 1mS for a 50% step load.               |                |                |                |                  |                  |                  |
| Current Sense Method          | Internal Shunt; External Shunt can be used for better temperature stability.                         |                |                |                |                  |                  |                  |

## OUTPUT – Module in Current Source Mode

Current Source - Programmable load compensation available for resistive and inductive loads; capacitive load applications; and LED drive applications

| MODULE CODE                | SL                                                                                                                                                              | SQ            | SW             | S8             | S1           | SA           | S2           |
|----------------------------|-----------------------------------------------------------------------------------------------------------------------------------------------------------------|---------------|----------------|----------------|--------------|--------------|--------------|
| Nominal Output (V)         | 12                                                                                                                                                              | 24            | 48             | 80             | 125          | 200          | 250          |
| Setting Range (A)          | 0.0 A - 200 A                                                                                                                                                   | 0.0 A - 120 A | 0.0 A - 62.5 A | 0.0 A - 37.5 A | 0.0 A - 24 A | 0.0 A - 15 A | 0.0 A - 12 A |
| RMS Ripple (mA)            | 200                                                                                                                                                             | 120           | 62.5           | 37.5           | 24           | 15           | 12           |
| Line Regulation (mA)       | 200                                                                                                                                                             | 120           | 125            | 93.75          | 48           | 50           | 24           |
| Load Regulation (mA)       | 800                                                                                                                                                             | 480           | 250            | 150            | 96           | 56           | 48           |
| P-P Ripple (mA)            | N/A                                                                                                                                                             |               |                |                |              |              |              |
| Drift (Temp Stability)     | ±0.05% of I <sub>out</sub> Rated over 8 hours, after 30 minute warm up, constant Line, Load and Temp                                                            |               |                |                |              |              |              |
| Temp Co-efficient (PPM/°C) | SL, SQ = 300 PPM; All other modules are 200 PPM.<br>Temp Co-efficient at rack level is [Temp Co-efficient (module level)] + [4500 PPM of I <sub>out</sub> -max] |               |                |                |              |              |              |
| Pgm Accuracy (A)           | 0.7% digital, 1.3% analog of rated output max                                                                                                                   |               |                |                |              |              |              |
| Pgm Resolution (mA)        | 79.2                                                                                                                                                            | 26.4          | 13.2           | 10             | 5.2          | 2.6          | 2.6          |
| Meas Accuracy              | 0.7% + 0.7% of Rated Output Max                                                                                                                                 |               |                |                |              |              |              |
| Meas Resolution            | 79.2                                                                                                                                                            | 26.4          | 13.2           | 10             | 5.2          | 2.6          | 2.6          |
| Transient Response         | 0-63% output current change in 7.5 mSec, residual value 1%, settling time 35 mSec                                                                               |               |                |                |              |              |              |
| Current Sense Method       | Internal Shunt / External Shunt                                                                                                                                 |               |                |                |              |              |              |



## Environmental Specifications

| Operating Conditions      | ALL MODELS (Unless Otherwise Specified)                                                                                                                                                                                                                                                                                                           |
|---------------------------|---------------------------------------------------------------------------------------------------------------------------------------------------------------------------------------------------------------------------------------------------------------------------------------------------------------------------------------------------|
| Operating Temperature     | 0 °C to +50 °C at 100% rated load.                                                                                                                                                                                                                                                                                                                |
| Storage Temperature       | -40 °C to +85 °C. For Liquid Cooled models, liquid must be drained before storage                                                                                                                                                                                                                                                                 |
| Operating Humidity        | 20% - 90% non condensing                                                                                                                                                                                                                                                                                                                          |
| Storage Humidity          | 10% - 95% non condensing                                                                                                                                                                                                                                                                                                                          |
| Operating Altitude        | Up to 9,842 feet above sea level (3,000 meters)                                                                                                                                                                                                                                                                                                   |
| Storage Altitude          | Up to 30,000 feet above sea level (9,144 meters)                                                                                                                                                                                                                                                                                                  |
| Vibration                 | Operating Sinusoidal Vibration MIL-STD-810G Method 528 Procedure I (Type 1):<br>NEBS Office Vibration Environment, Alternate Procedure<br>Operating Random Vibration: IPC-9592B Class 1<br>Non-Operating Vibration (Packaged): IPC-9592B Class 1; MIL-STD-810G, Method 514.6, Procedure 1, Category 7, Table 514.6C-VII General Exposure          |
| Shock                     | MIL-STD-810G Method 516.6 Procedures I, II, IV, VI                                                                                                                                                                                                                                                                                                |
| Shipping and Handling     | NSTA for <100 lbs; MIL-STD-2073-1 >100 lbs                                                                                                                                                                                                                                                                                                        |
| Cooling and Audible Noise | <65 dBA with 80% load @ 30 °C at nominal input voltage with Smart Fan algorithm to be optimized based on module and rack thermal sensors. When modules are inhibited via software control, the fan speed is reduced to idle and acoustic noise is <46 dBA. With modules off via front panel switch fans are at idle for 1 min, and off for 9 min. |
| Ingress Protection        | Fan Cooled = IP20                                                                                                                                                                                                                                                                                                                                 |
| Pollution Degree          | 2                                                                                                                                                                                                                                                                                                                                                 |
| RoHS Compliance           | Yes                                                                                                                                                                                                                                                                                                                                               |

Module and Marking Detail



Standard Markings

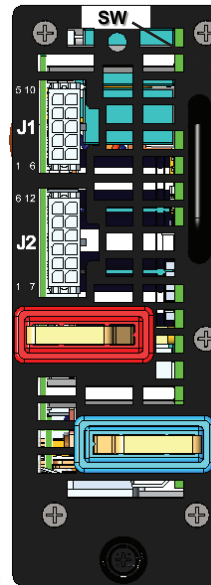

Module Code Label

## Ordering Information

| CASE CODE         |                                            | MODULE CODES<br>(up to 8 modules) |            | PARALLEL/SERIES CASE CODE     |                                | MOD CODE |
|-------------------|--------------------------------------------|-----------------------------------|------------|-------------------------------|--------------------------------|----------|
| iHP**XYA-         |                                            | XV-                               |            | -XX                           |                                | -XXX     |
| Case Decoder      | iHP**XYA                                   | Module Decoder                    | XV         | Case Code Decoder First Digit | Case Code Decoder Second Digit |          |
| ** = Case Power   |                                            | X = Output Type                   |            | 0 = None                      | 0 = None                       |          |
|                   | 12 = 12 KW 19" Rack<br>24 = 24 KW 19" Rack |                                   | S = Single | 1 = Slot 1&2                  | P = Parallel                   |          |
| X = Voltage Range |                                            | V = Nominal Voltage               |            | 2 = Slot 2&3                  | S = Series                     |          |
|                   | L = Low Range*180-264                      |                                   | L = 12 V   | 3 = Slot 3&4                  | 1 = Combo 2 P/S                |          |
|                   | H = High Range 342-528                     |                                   | Q = 24 V   | 4 = Slot 4&5                  | 2 = Combo 2 S/P                |          |
| Y = Input Phase   |                                            |                                   | W = 48 V   | 5 = Slot 5&6                  | 3 = Combo 3 P/P/S              |          |
|                   | 1 = Single Phase<br>3 = 3-Phase            |                                   | 8 = 80 V   | 6 = Slot 6&7                  | 4 = Combo 3 P/S/P              |          |
| Z = Cooling       |                                            |                                   | 1 = 125 V  | 7 = Slot 7&8                  | 5 = Combo 3 P/S/S              |          |
|                   | A = Air Cooled                             |                                   | 2 = 250 V  | 8 = Slot 1,2&3                | 6 = Combo 3 S/P/P              |          |
|                   |                                            |                                   |            | 9 = Slot 1,2,3&4              | 7 = Combo 3 S/P/S              |          |
|                   |                                            |                                   |            | A = Slot 1,2,3,4&5            | 8 = Combo 3 S/S/P              |          |
|                   |                                            |                                   |            | B = Slot 1,2,3,4,5&6          | 9 = Combo 4 P/P/P/S            |          |
|                   |                                            |                                   |            | C = Slot 1,2,3,4,5,6&7        | A = Combo 4 P/P/S/P            |          |
|                   |                                            |                                   |            | D = Slot 1,2,3,4,5,6,7&8      | B = Combo 4 P/P/S/S            |          |
|                   |                                            |                                   |            | E = Slot 1&2; 3&4             | C = Combo 4 P/S/P/P            |          |
|                   |                                            |                                   |            | F = Slot 1&2; 3&4; 5&6        | D = Combo 4 P/S/P/S            |          |
|                   |                                            |                                   |            | G = Slot 1&2; 3&4; 5&6; 7&8   | E = Combo 4 P/S/S/P            |          |
|                   |                                            |                                   |            | H = Slot 1,2&3; 4&5           | F = Combo 4 P/S/S/S            |          |
|                   |                                            |                                   |            | J = Slot 1,2&3; 4&5; 6&7      | G = Combo 4 S/P/P/P            |          |
|                   |                                            |                                   |            | K = Slot 1,2&3; 4,5&6         | H = Combo 4 S/P/P/S            |          |
|                   |                                            |                                   |            | L = Slot 1,2&3; 4,5&6; 7&8    | J = Combo 4 S/P/S/P            |          |
|                   |                                            |                                   |            | M = Slot 1,2,3&4; 5&6         | K = Combo 4 S/P/S/S            |          |
|                   |                                            |                                   |            | N = Slot 1,2,3&4; 5&6; 7&8    | L = Combo 4 S/S/P/P            |          |
|                   |                                            |                                   |            | P = Slot 1,2,3&4; 5,6&7       | M = Combo 4 S/S/P/S            |          |
|                   |                                            |                                   |            | R = Slot 1,2,3&4; 5,6,7&8     | N = Combo 4 S/S/S/P            |          |
|                   |                                            |                                   |            | S = Slot 1,2,3,4&5; 6&7       |                                |          |
|                   |                                            |                                   |            | T = Slot 1,2,3,4&5; 6,7&8     |                                |          |
|                   |                                            |                                   |            | U = Slot 1,2,3,4,5&6; 7&8     |                                |          |

\*Lowest possible input for the 24 kW version is 187.5 Vac

### MODEL NUMBER SHORTCUT

For repeated like modules in parallel or series, instead of listing all the same modules separated by a "-", you can simply list the module once and then follow by the number of times it repeats enclosed in parenthesis.

For example:

**iHP24H3A-SW-SW-SW-SW-SW-SW-S8-S8-00**

would become:

**iHP24H3A-SW(6)-S8(2)-00**

## Case Specs - Outline Detail

**Front Panel Standard Markings**  
(Standard for both 12 KW and 24 KW)



**Input and Comms Standard Markings**  
(View of 24KW shown. Comms interface is horizontal on the 12KW). See mechanical drawings.



## Module Specs - Outline Detail

### Module J1 Signals

| Pin # | Function       | Function      | Pin # |
|-------|----------------|---------------|-------|
| 5     | 4-20mA_IPROG   | SYS_M_FAULT#  | 10    |
| 4     | 0-5VEXT_IPROG  | SYS_M_ENABLE# | 9     |
| 3     | 0-10VEXT_IPROG | SYS_RTN       | 8     |
| 2     | 0-5VEXT_VPROG  | SYS_M_INHIBIT | 7     |
| 1     | 0-10VEXT_VPROG | 4-20mA_VPROG  | 6     |

### Module J2 Signals

| Pin # | Function    | Function    | Pin # |
|-------|-------------|-------------|-------|
| 6     | Dummy Net   | Dummy Net   | 12    |
| 5     | IMON        | VMON        | 11    |
| 4     | D_RTN       | ISHARE      | 10    |
| 3     | EXT_ISENSE+ | EXT_ISENSE- | 9     |
| 2     | D_RTN       | V_SNS-      | 8     |
| 1     | V_SNS+      | D_RTN       | 7     |

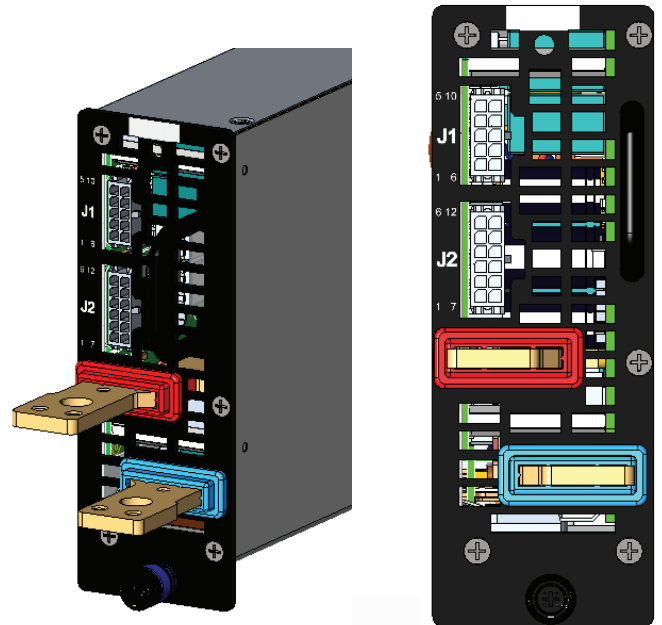

J1 mating housing Molex Micro-fit MPN: 43025-1000  
 J2 mating housing Molex Micro-fit MPN: 43025-1200  
 Crimp Terminal AWG 20-24  
 Crimp Terminal Molex MPN: 43030-0002

## iHP24 Series - Mechanical Drawings

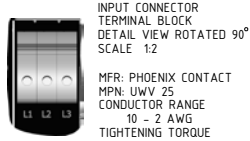

INPUT CONNECTOR  
TERMINAL BLOCK  
DETAIL VIEW ROTATED 90°  
SCALE 1:2

MFR: PHOENIX CONTACT  
MPN: UWV 25  
CONDUCTOR RANGE  
10 - 2 AWG  
TIGHTENING TORQUE  
4.5 N-m MAX

- NOTE:
1. WEIGHT:  
RACK STANDALONE, 35.4 Kg  
RACK WITH 8 MODULES, 52.9 Kg
  2. REFER TO PRODUCT LABELS FOR SAFETY INFORMATION AND SPECIAL INSTRUCTIONS.
  3. REFER TO PRODUCT SPECIFICATION FOR OPERATIONAL ENVIRONMENT.
  4. DO NOT OBSTRUCT INLET AND OUTLETS.

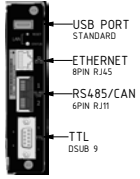
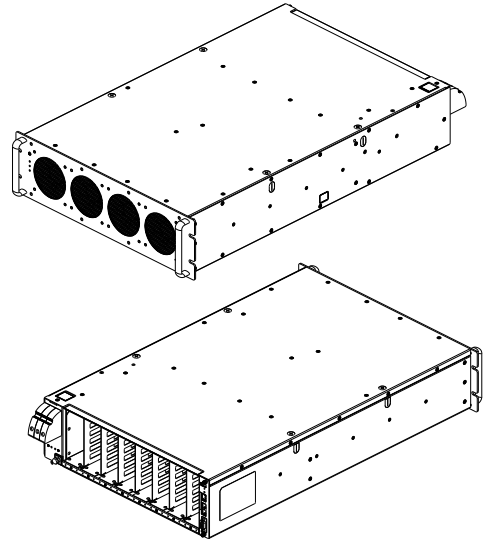
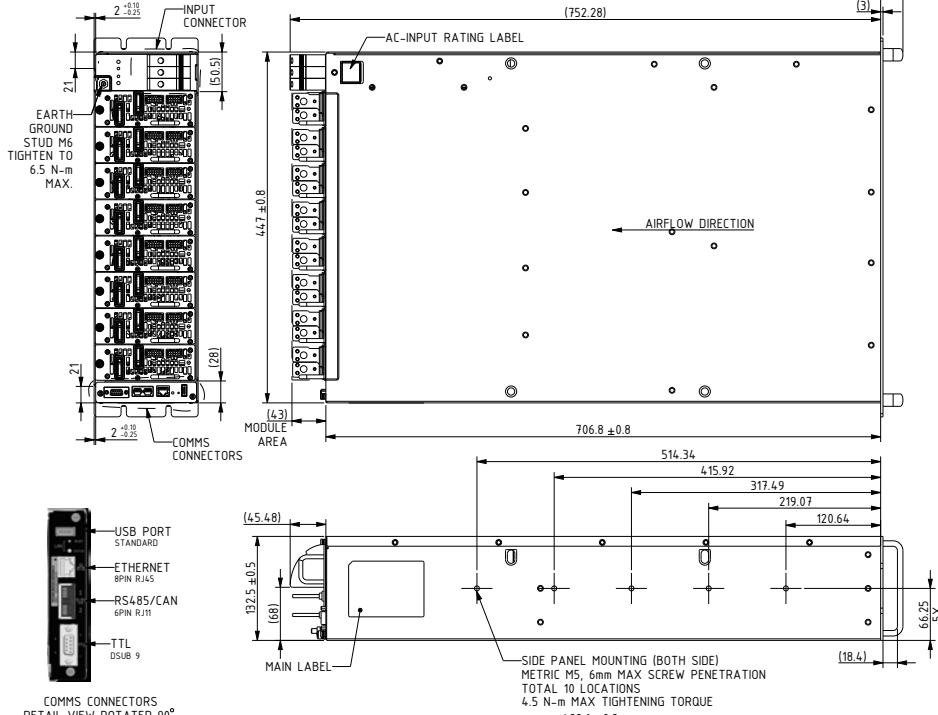

COMMS CONNECTORS  
DETAIL VIEW ROTATED 90°  
SCALE 1:2

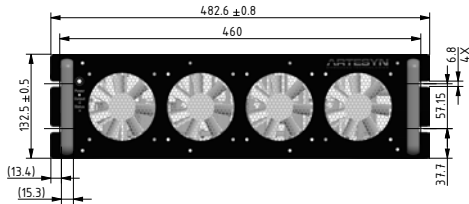



iHP12 Series - Mechanical Drawings



## iHP Modules - Mechanical Drawings



## PowerPro Connect Module



### POWERPRO

**Part number:73-778-000**

The PowerPro Connect Module (purchased separately) can provide standard Ethernet interface via the internet to a cloud- and dashboard-based user-configurable GUI.

### WORLDWIDE OFFICES

#### Americas

2900 South Diablo Way  
Suite B100  
Tempe, AZ 85282, USA  
+1 888 412 7832

#### Europe (UK)

Ground Floor Offices, Barbary House  
4 Harbour Buildings, Waterfront West  
Brierley Hill, West Midlands  
DY5 1LN, UK  
+44 (0) 1384 842 211

#### Asia (HK)

14/F, Lu Plaza  
2 Wing Yip Street  
Kwun Tong, Kowloon  
Hong Kong  
+852 2176 3333

**ARTESYN™**  
An Advanced Energy Company

[www.artesyn.com](http://www.artesyn.com)

Artesyn Embedded Technologies, Artesyn Embedded Power, Artesyn, and all Artesyn related logos are trademarks and service marks of Artesyn Embedded Technologies, Inc. All other names and logos referred to are trade names, trademarks, or registered trademarks of their respective owners. Specifications are subject to change without notice. © 2019 Artesyn Embedded Technologies, Inc. All rights reserved. For full legal terms and conditions, please visit [www.artesyn.com/legal](http://www.artesyn.com/legal).

For more information: [www.artesyn.com](http://www.artesyn.com)  
For support: [productsupport.ep@artesyn.com](mailto:productsupport.ep@artesyn.com)



Компания «ЭлектроПласт» предлагает заключение долгосрочных отношений при поставках импортных электронных компонентов на взаимовыгодных условиях!

Наши преимущества:

- Оперативные поставки широкого спектра электронных компонентов отечественного и импортного производства напрямую от производителей и с крупнейших мировых складов;
- Поставка более 17-ти миллионов наименований электронных компонентов;
- Поставка сложных, дефицитных, либо снятых с производства позиций;
- Оперативные сроки поставки под заказ (от 5 рабочих дней);
- Экспресс доставка в любую точку России;
- Техническая поддержка проекта, помощь в подборе аналогов, поставка прототипов;
- Система менеджмента качества сертифицирована по Международному стандарту ISO 9001;
- Лицензия ФСБ на осуществление работ с использованием сведений, составляющих государственную тайну;
- Поставка специализированных компонентов (Xilinx, Altera, Analog Devices, Intersil, Interpoint, Microsemi, Aeroflex, Peregrine, Syfer, Eurofarad, Texas Instrument, Miteq, Cobham, E2V, MA-COM, Hittite, Mini-Circuits, General Dynamics и др.);

Помимо этого, одним из направлений компании «ЭлектроПласт» является направление «Источники питания». Мы предлагаем Вам помощь Конструкторского отдела:

- Подбор оптимального решения, техническое обоснование при выборе компонента;
- Подбор аналогов;
- Консультации по применению компонента;
- Поставка образцов и прототипов;
- Техническая поддержка проекта;
- Защита от снятия компонента с производства.



#### Как с нами связаться

**Телефон:** 8 (812) 309 58 32 (многоканальный)

**Факс:** 8 (812) 320-02-42

**Электронная почта:** [org@eplast1.ru](mailto:org@eplast1.ru)

**Адрес:** 198099, г. Санкт-Петербург, ул. Калинина, дом 2, корпус 4, литера А.