

### Product Overview

The QPB2328 is an HBT RF balanced amplifier IC operating as a return path amplifier capable of supporting DOCSIS 3.1 applications. This IC is designed to provide a low noise, high gain option for 5-210MHz interface using an 8V power supply to provide lower overall power dissipation. The QPB2328 can also be used in 5V and single ended applications with reduced linearity requirements. The QPB2328 is packaged in a convenient SOIC8 package and features an externally adjustable bias control.



Package: SOIC-8 with Exposed Pad

### Functional Block Diagram

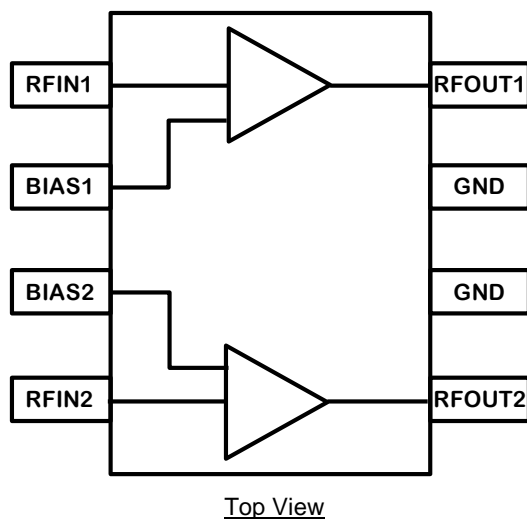

### Key Features

- 5MHz to 210MHz Operation
- 8V and 5V Operation
- Gain; 17.5dB Typical
- Noise Figure 3.5dB Typical
- Adjustable Bias Using External Resistors
- SOIC-8 Exposed Pad

### Applications

- Head End CMTS Equipment
- Post Amp for Return Path Optical Receivers
- DOCSIS 3.1 Optical Nodes
- Residential Amplifiers and Splitters

### Ordering Information

Part No.	Description
QPB2328SQ	Sample bag with 25 pieces
QPB2328SR	7" Reel with 100 pieces
QPB2328TR13	13" Reel with 2500 pieces
QPB2328PCK	5 – 210 MHz PCBA with 5 pc sample bag

### Absolute Maximum Ratings

Parameter	Rating
Supply Voltage (V <sub>DD</sub> )	+10V
Supply Current (I <sub>DD</sub> )	350mA
Maximum CW Input Power for V <sub>DD</sub> =8V	+16dBm
Operating Temperature Range	-40 to +85 °C
Storage Temperature Range	-65 to +150 °C
Maximum Junction Temperature	+150 °C

Exceeding any one or a combination of the Absolute Maximum Rating conditions may cause permanent damage to the device. Extended application of Absolute Maximum Rating conditions to the device may reduce device reliability.

### Electrical Specifications – Push-Pull Configuration, 8V

Parameter	Condition <sup>(1)</sup>	Min	Typ	Max	Unit
Supply Voltage (V <sub>DD</sub> )			8		V
Supply Current (I <sub>DD</sub> )			235		mA
Frequency Range		5		210	MHz
Gain	Full Band		17.8		dB
Gain Flatness			±0.2		dB
Gain Tilt	Gain(210MHz) - Gain(5MHz)		0.15		dB
Input Return Loss	Full Band		19		dB
Output Return Loss	Full Band		25		dB
Reverse Isolation	Full Band		22		dB
Noise Figure	Includes balun loss		3.5		dB
DTO	f1=13MHz, f2=19MHz 61dBmV per tone		70		-dBc
DSO	f1=13MHz, f2=19MHz 61dBmV per tone		82		-dBc
ACLR	P <sub>out</sub> = 64dBmV, 5-195MHz OFDM w/ 9.6MHz exclusion band.		63		dB
OIP2	12dBm/tone, F1 = 113MHz, F2 = 119MHz		93		dBm
OIP3	12dBm/tone, F1 = 113MHz, F2 = 119MHz		46		dBm
Output P1dB	Full Band		27		dBm
Thermal Resistance	Θ <sub>JC</sub>		12		°C/W

Notes:

1. Typical performance at these conditions: Temp = +25°C, V<sub>DD</sub> = +8V, 75Ω system

### Electrical Specifications – Single Ended, 8V (50Ω)

Parameter	Condition <sup>(1)</sup>	Min	Typ	Max	Unit
Supply Current (I <sub>DD</sub> )			114		mA
Gain			17.75		dB
OIP2L	9dBm/tone, F1 = 113MHz, F2 = 123MHz		57.7		dBm
OIP2H	9dBm/tone, F1 = 113MHz, F2 = 123MHz		58.8		dBm
OIP3	9dBm/tone, F1 = 113MHz, F2 = 123MHz		43.9		dBm

Notes:

1. Typical performance at these conditions: Singled ended configuration, Temp = +25°C, V<sub>DD</sub> = +8V, **50Ω system**
2. 50ohm data represents factory test conditions

### Electrical Specifications – Push-Pull Configuration, 5V

Parameter	Condition <sup>(1)</sup>	Min	Typ	Max	Unit
Supply Voltage (V <sub>DD</sub> )			5		V
Supply Current (I <sub>DD</sub> )			100		mA
Frequency Range		5		210	MHz
Gain	Full Band		17.5		dB
Gain Flatness			±0.2		dB
Gain Tilt	Gain(210MHz) - Gain(5MHz)		0.15		dB
Input Return Loss	Full Band		19		dB
Output Return Loss	Full Band		24		dB
Reverse Isolation	Full bandwidth		22		dB
Noise Figure	Includes balun loss		3.5		dB
DTO	f1=13MHz, f2=19MHz 53dBmV per tone		64		-dBc
D50	f1=13MHz, f2=19MHz 53dBmV per tone		76		-dBc
ACLR	Pout = 56dBmV, 5-195MHz OFDM w/ 9.6MHz exclusion band.		62		dB
OIP2	4dBm/tone, F1 = 113MHz, F2 = 119MHz		82		dBm
OIP3	4dBm/tone, F1 = 113MHz, F2 = 119MHz		36.5		dBm
Output P1dB	Full Band		22		dBm

Notes:

1. Typical performance at these conditions: Temp = +25°C, V<sub>DD</sub> = +5V, 75Ω system



### Electrical Specifications – Single Ended Configuration, 5V

Parameter	Condition <sup>(1)</sup>	Min	Typ	Max	Unit
Supply Voltage ( $V_{DD}$ )			5		V
Supply Current ( $I_{DD}$ )			55		mA
Frequency Range		5		210	MHz
Gain	Full Band		18.7		dB
Gain Flatness			$\pm 0.2$		dB
Gain Tilt	Gain(210MHz) - Gain(5MHz)		0.2		dB
Input Return Loss	Full Band		22		dB
Output Return Loss	Full Band		21		dB
Reverse Isolation	Full bandwidth		21		dB
Noise Figure	Full bandwidth		3		dB
DTO	f1=13MHz, f2=19MHz 46dBmV per tone		74		-dBc
DSO	f1=13MHz, f2=19MHz 46dBmV per tone		49		-dBc
ACLR	Pout = 48dBmV, 5-195MHz OFDM w/ 9.6MHz exclusion band.		61		dB
OIP2	-3dBm/tone, F1 = 113MHz, F2 = 119MHz		47		dBm
OIP3	-3dBm/tone, F1 = 113MHz, F2 = 119MHz		36		dBm
Output P1dB	Full Band		19.5		dBm

Notes:

1. Typical performance at these conditions: Temp = +25°C,  $V_{DD}$  = +5V applied to single ended amplifier path, 75Ω system

**Evaluation Board Schematic 5-210MHz**

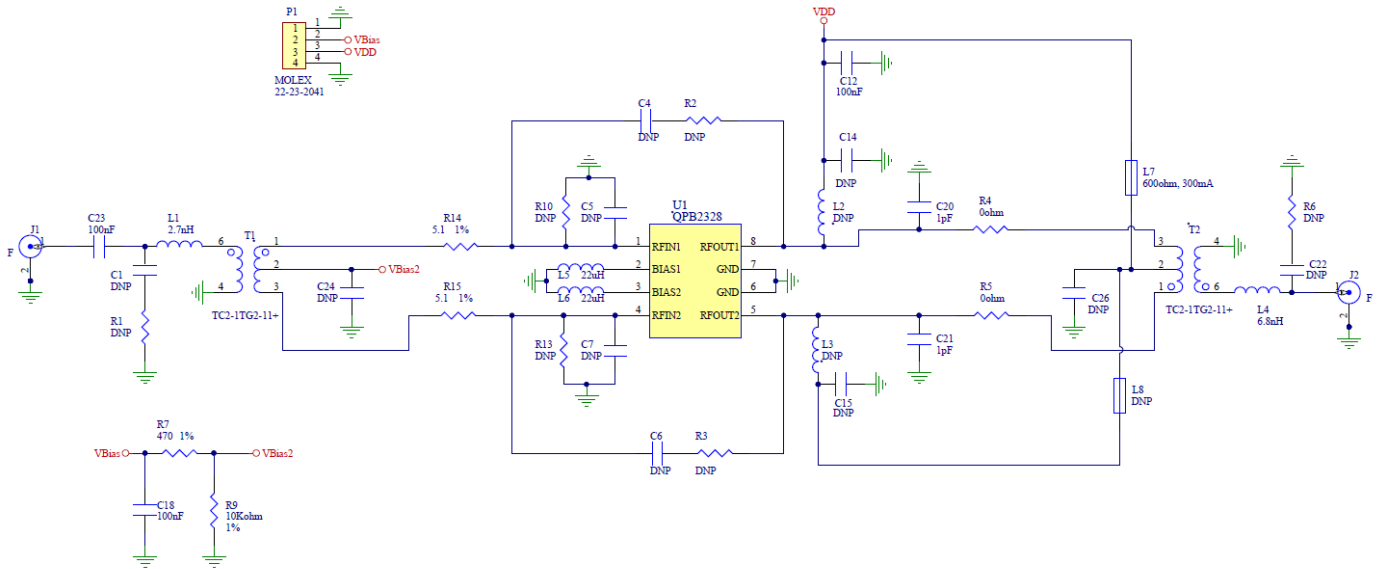



# QPB2328

## 17.5 dB Balanced Return Path Amplifier 5 – 210 MHz

### Evaluation Board Bill of Materials

Designator	Description	Manufacturer	Part Number
PCB	QPB2318-4000	DDI	QPB2318-4000(A)
C12, C18, C23	CAP, 0.1uF, 10%, 16V, X7R, 0402	Murata Electronics	GRM155R71C104KA88D
C20, C21	1.0PF, .1PF, 50, NPO, 0402, LF LEAD FREE	Murata Electronics	GRM1555C1H1R0BZ01D
J1, J2	CONN, F FEM EDGE MOUNT, 75 OHMS, 0.068"	Millimeter Wave Technologies, LLC	MW-846-C-DD-75
L1	IND, 2.7nH, +/-0.3nH, M/L, 0402	Murata Electronics	LQG15HS2N7S02D
L4	IND, 6.8nH, 5%, M/L, 0402	Murata Electronics	LQG15HN6N8J02D
L5, L6	IND, 22uH, 20%, 190mA, M/L, 0603	TDK	MLZ1608N220LT000
L7	FER, BEAD, 600 OHM, 300mA, 0402	Murata	BLM15HG601SN
P1	CONN, HDR, ST, FRCTN LOCK, 4-PIN	MOLEX	22-23-2041
R14, R15	RES, 5.1 OHM, 1%, 1/10W, 0402	Kamaya, Inc	RMC1/16SK5R10FTH
R4, R5	JMPR, 0 OHM, 0402	Panasonic Industrial Devices Sales	ERJ-2GE0R00
R7	Res, 470R /1%/0402/TK100/Chip	Kamaya, Inc	RMC1/16SK4700FTH
R9	RES, 10K, 1%, 1/16W, 0402	Panasonic Industrial Devices Sales	ERJ-2RKF1002X
T1, T2	XFMR, 3-300MHz, 50 OHM, 250mW, AT224-3	Minicircuits	TC2-1TG2-11+
U1	17.5dB High-Linearity Push-Pull MMIC	Qorvo	QPB2328
C1, C4, C5, C6, C7, C14, C15, C22, C24, C26, L2, L3, L8, R1, R2, R3, R6, R10, R13	DNP	N/A	N/A
HS1	Heat Sink 1.5 x 2	Shenzhen Minxingda Automation Equip	211086
S1, S2, S3, S4	Screw, 2-56x3/16:, Socket Head	McMaster-Carr Supply Co.	92196A076

## Evaluation Board Assembly Drawing

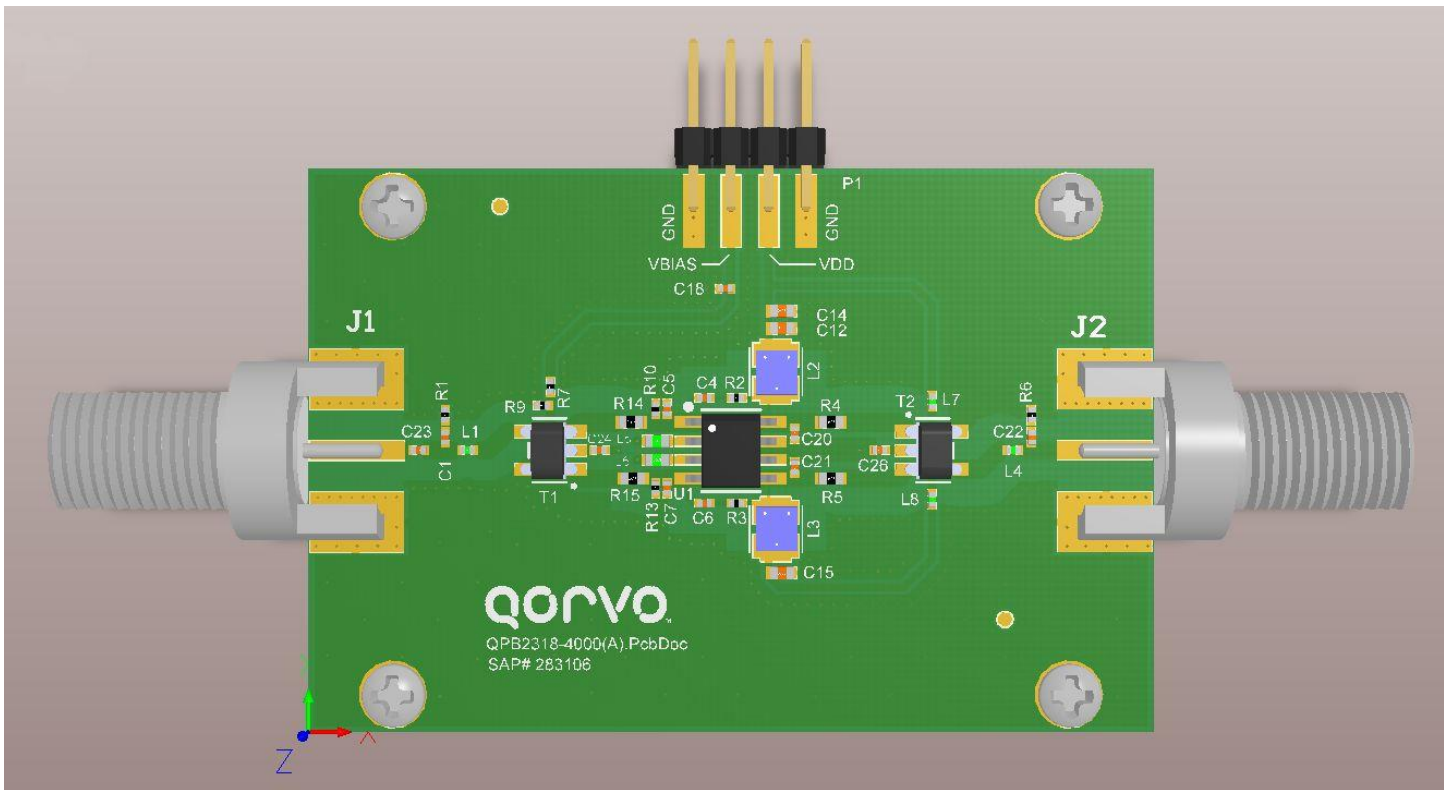

**Typical Application Schematic – Push-Pull Configuration**

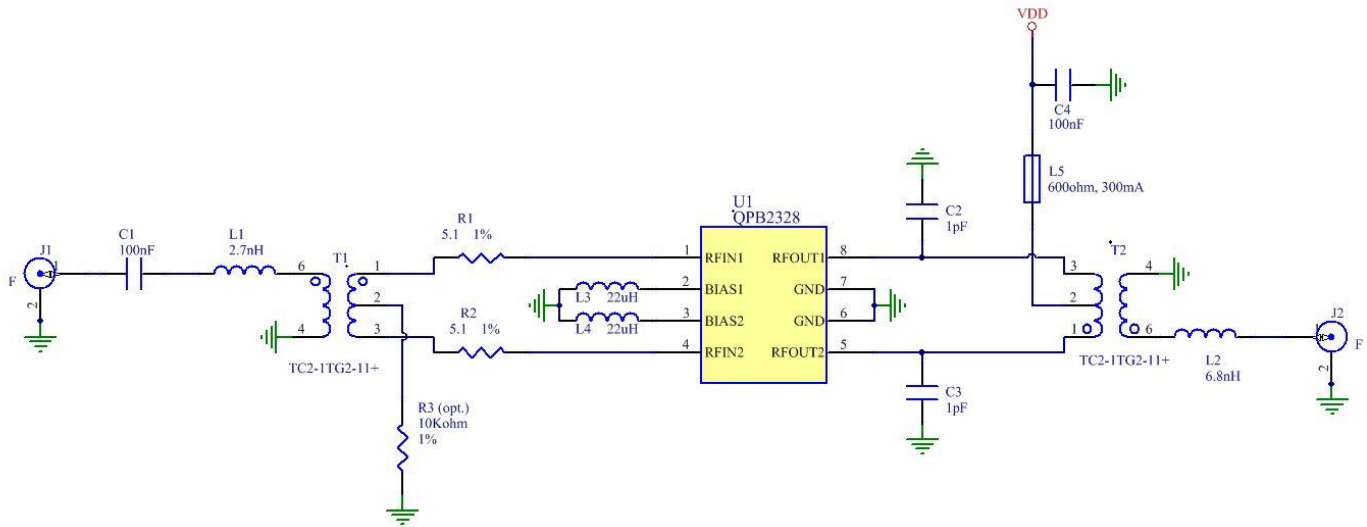

**Typical Application Schematic – Single Ended Configuration**

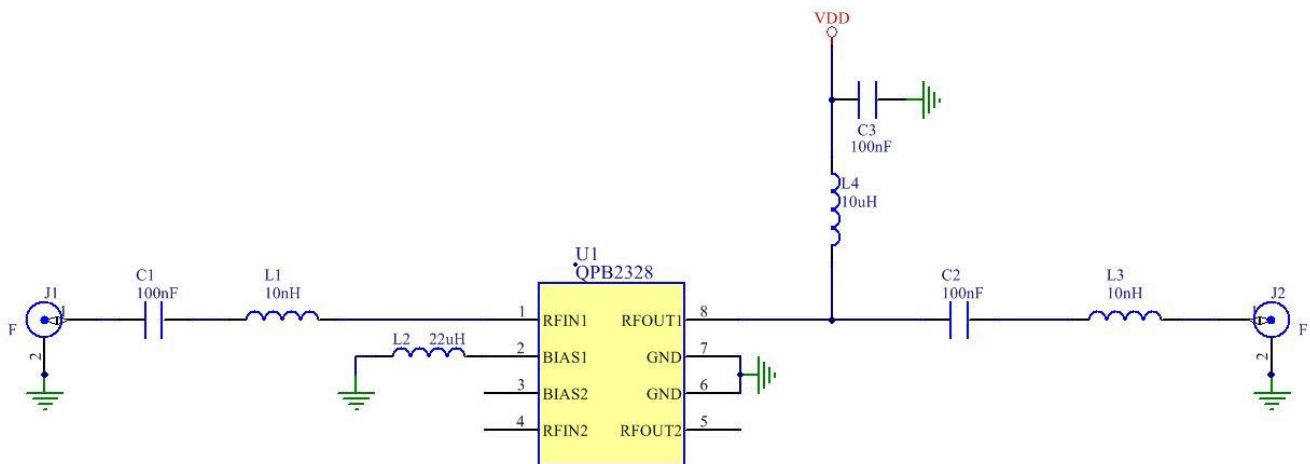



**Performance Data – Push-Pull Configuration, 8V**

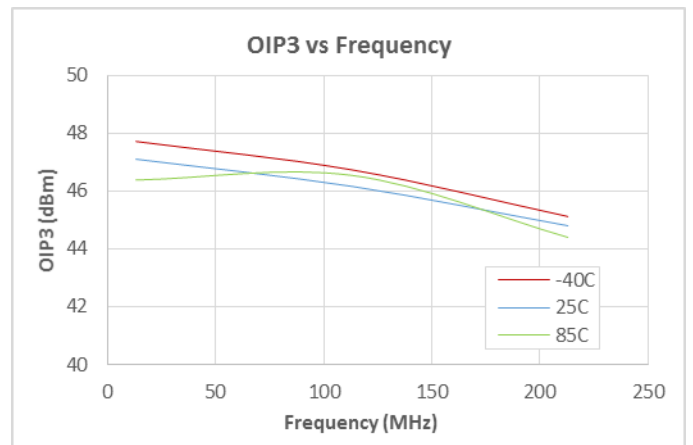
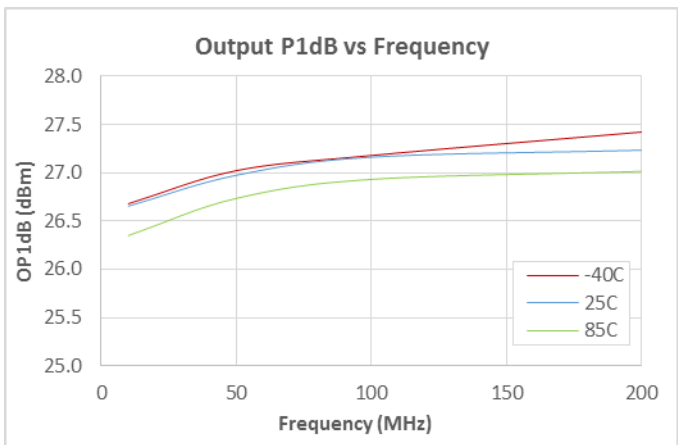
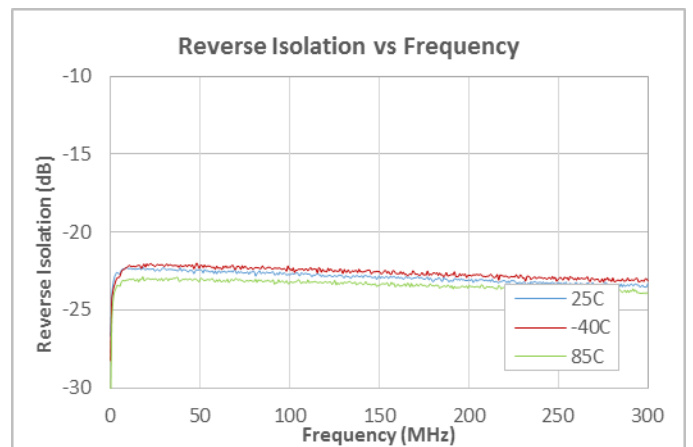
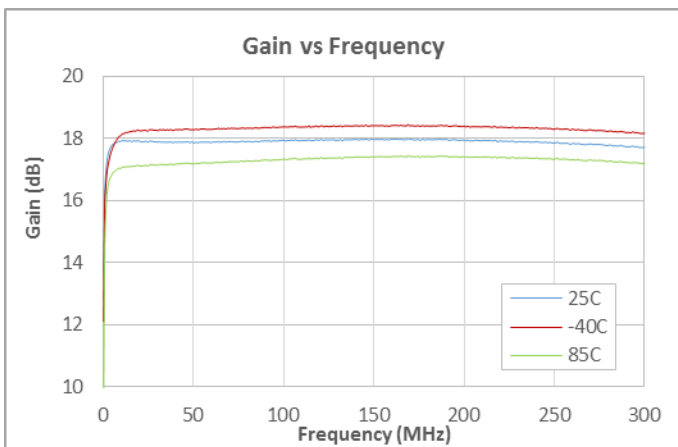
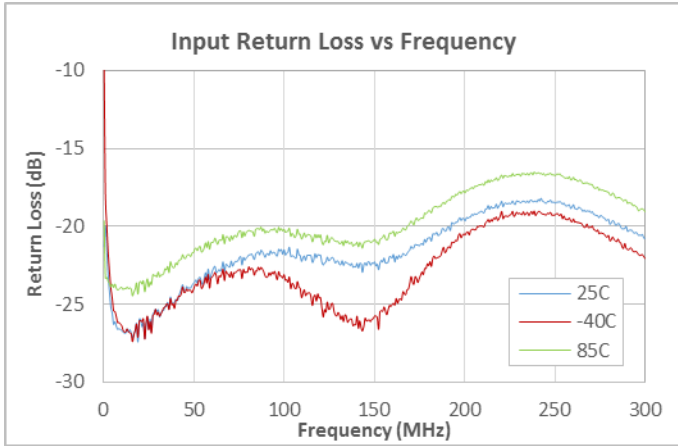

Notes:  
(1) OIP3: 12dBm/tone, F1 = 113MHz, F2 = 119MHz

### Performance Data – Push-Pull Configuration, 8V

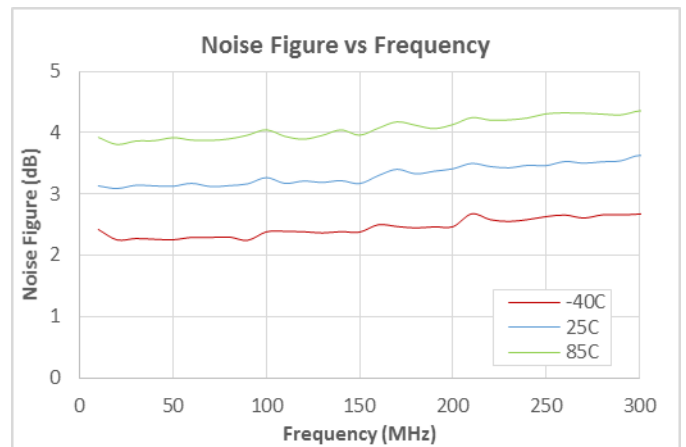
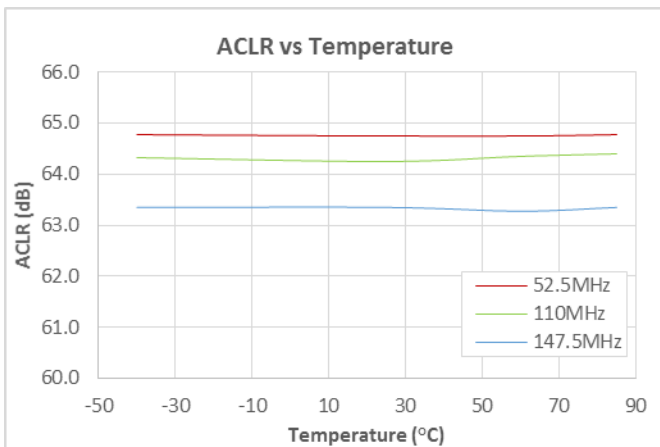
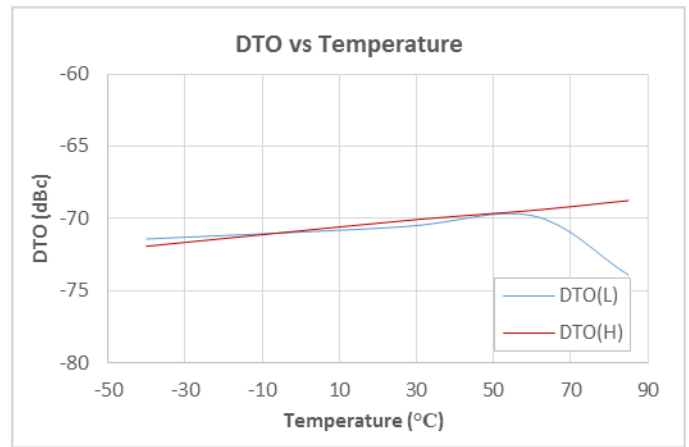
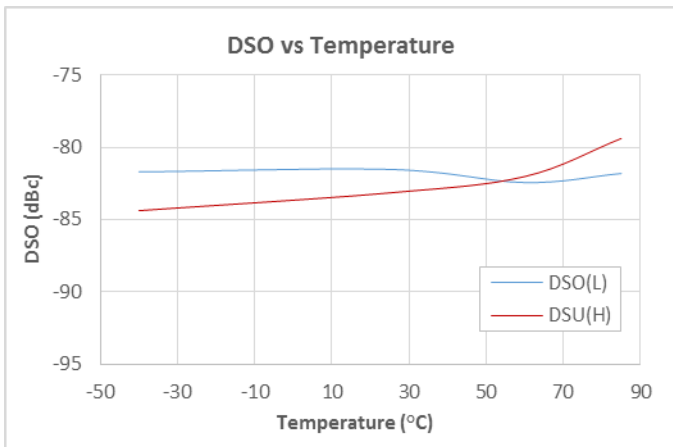
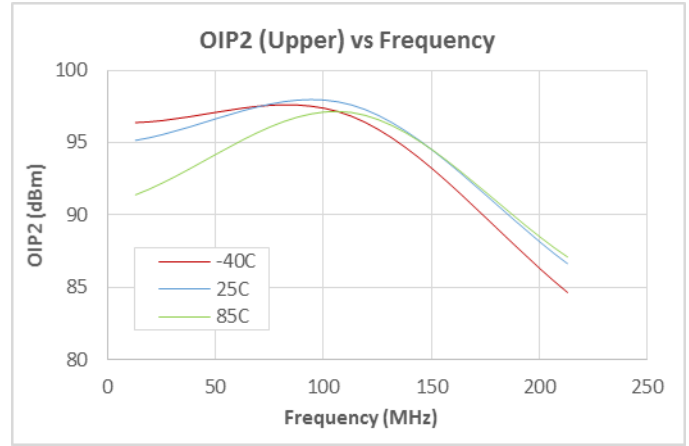
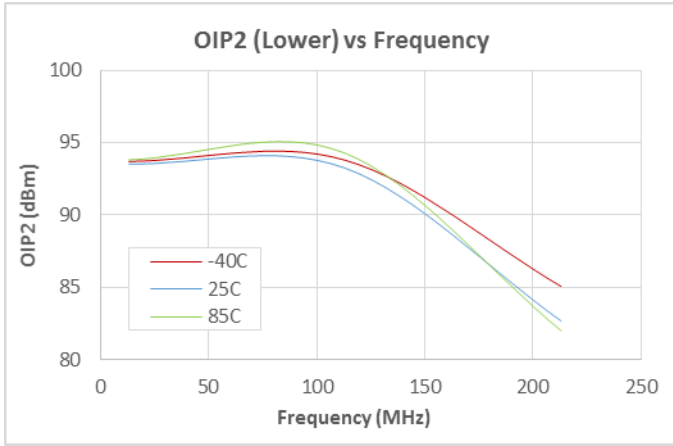

**Notes:**

- (2) OIP2: 12dBm/tone, F1 = 113MHz, F2 = 119MHz
- (3) DSO/DTO: f1=13MHz, f2=19MHz 61dBmV per tone
- (4) ACLR: Pout = 64dBmV, 5-195MHz OFDM w/ 9.6MHz exclusion band.

**Performance Data – Push-Pull Configuration, 8V**

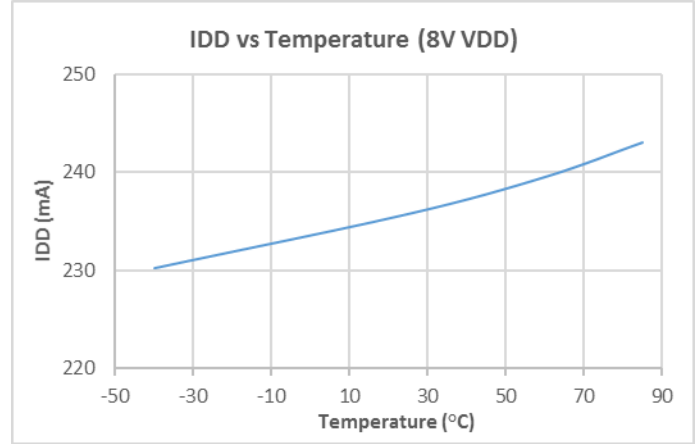
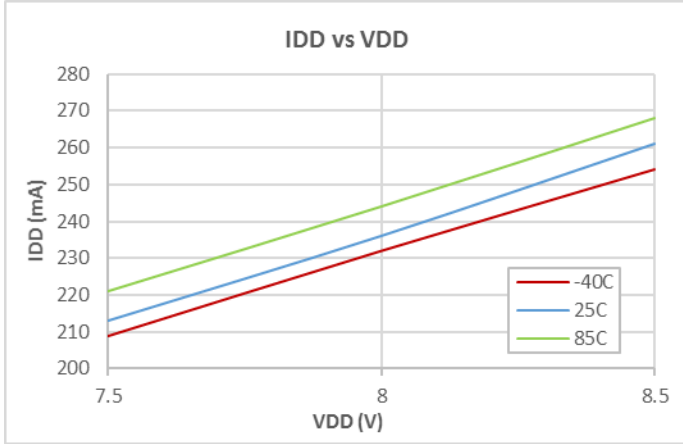

**Performance Data – Push-Pull Configuration, 5V**

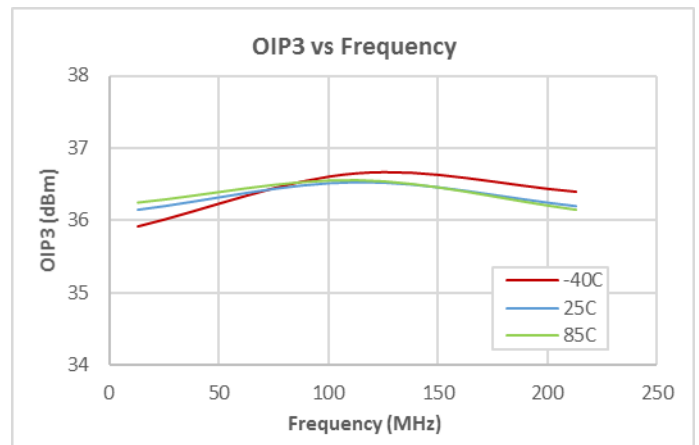
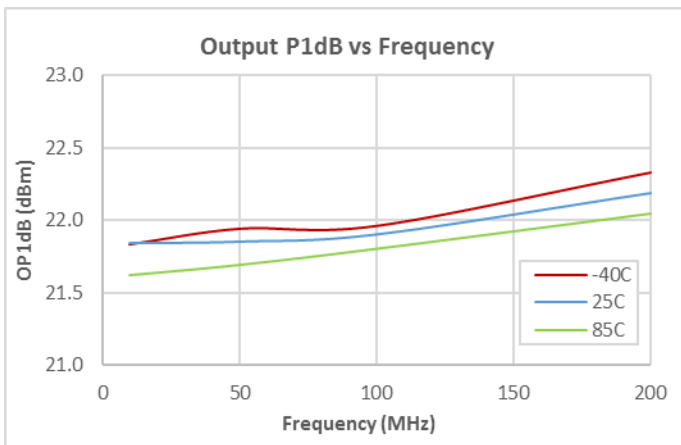
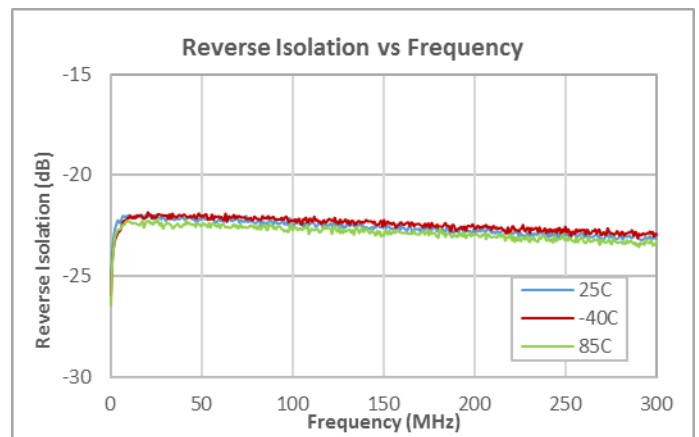
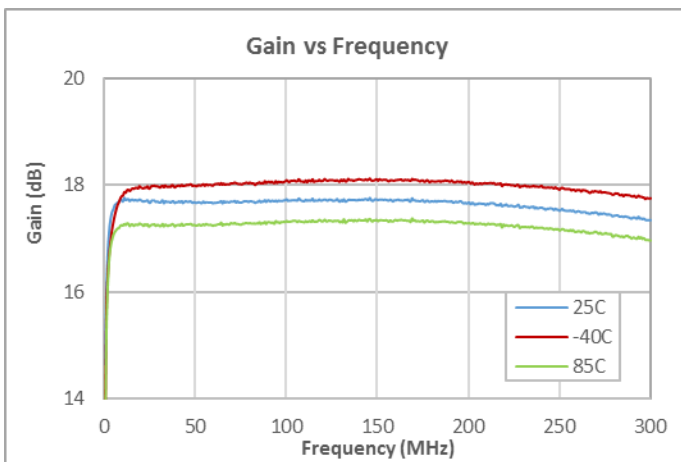
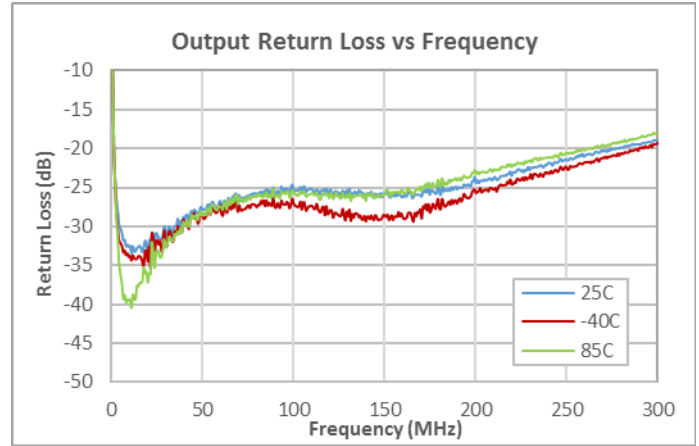

**Notes:**

- (1) OIP3: 4dBm/tone, F1 = 113MHz, F2 = 119MHz

**Performance Data – Push-Pull Configuration, 5V**

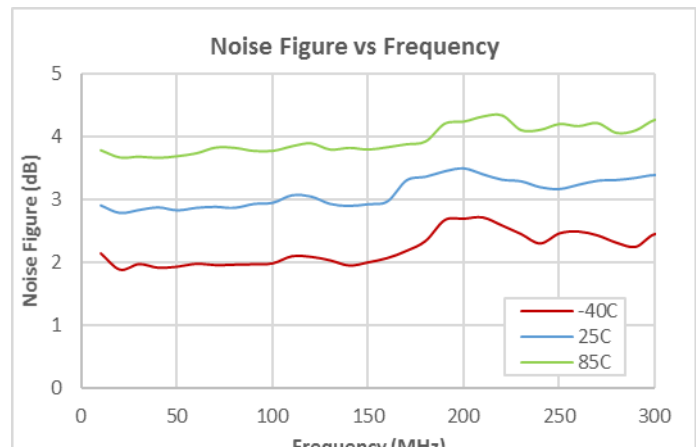
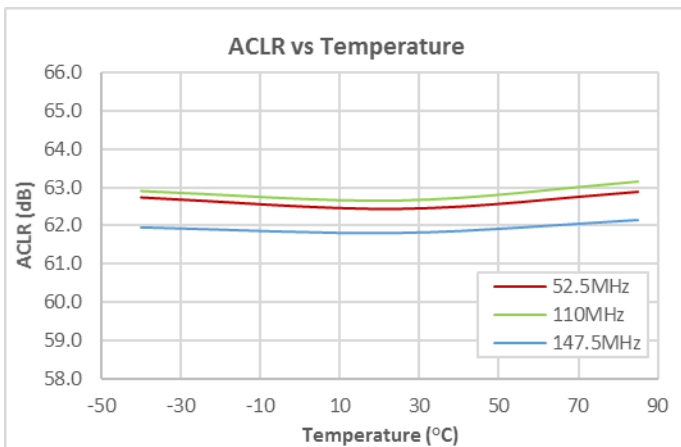
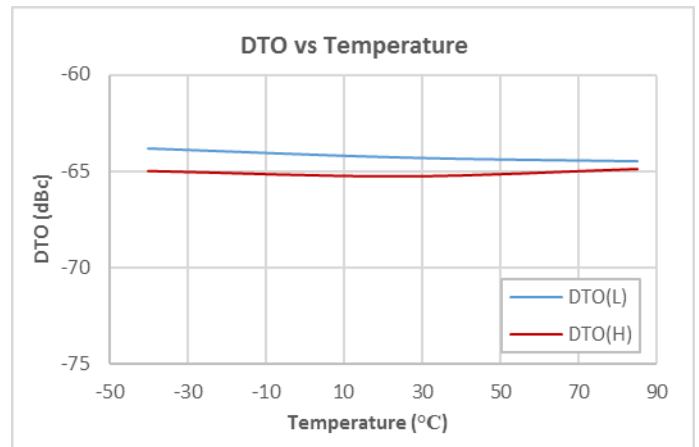
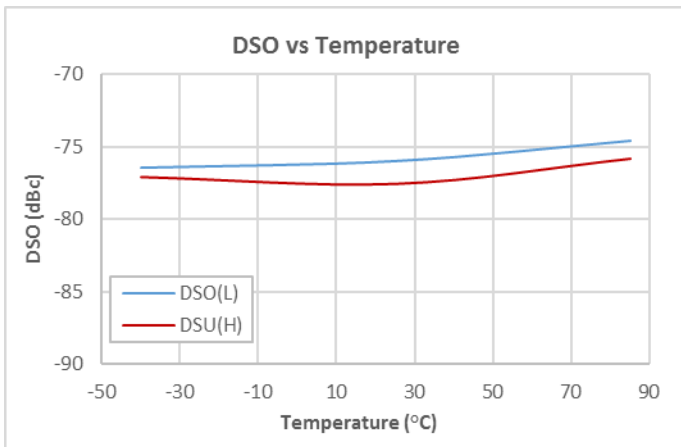
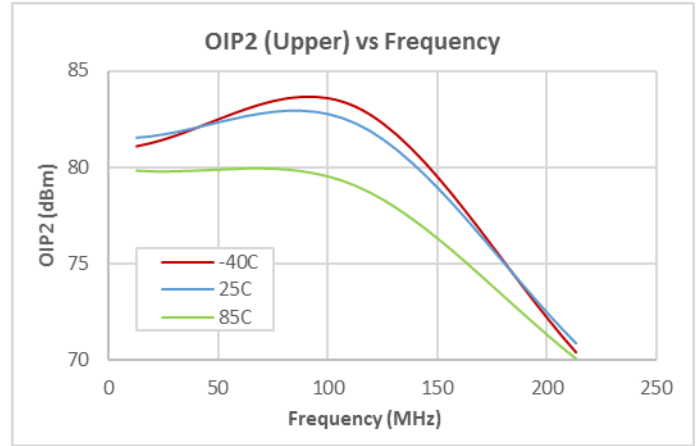
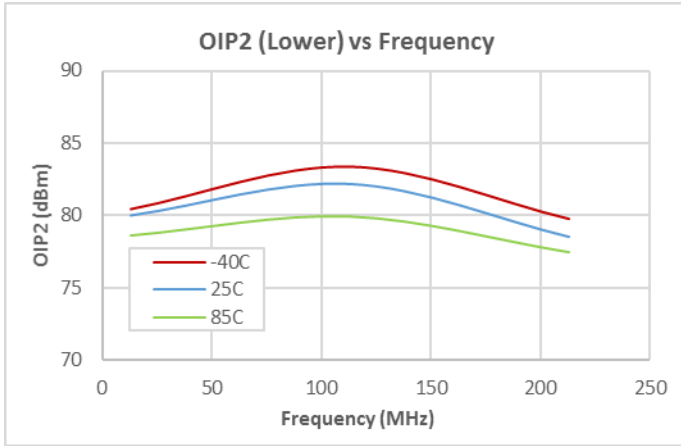

**Notes:**

- (1) OIP2: 4dBm/tone, F1 = 113MHz, F2 = 119MHz
- (2) DSO/DTO: f1=13MHz, f2=19MHz 53dBmV per tone
- (3) ACLR: Pout = 56dBmV, 5-195MHz OFDM w/ 9.6MHz exclusion band.

**Performance Data – Push-Pull Configuration, 5V**

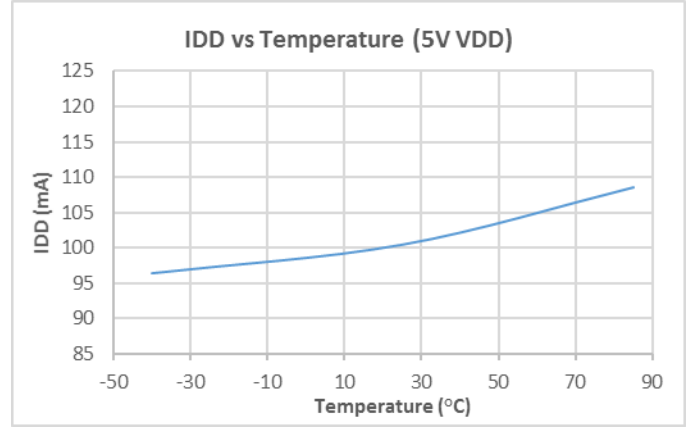
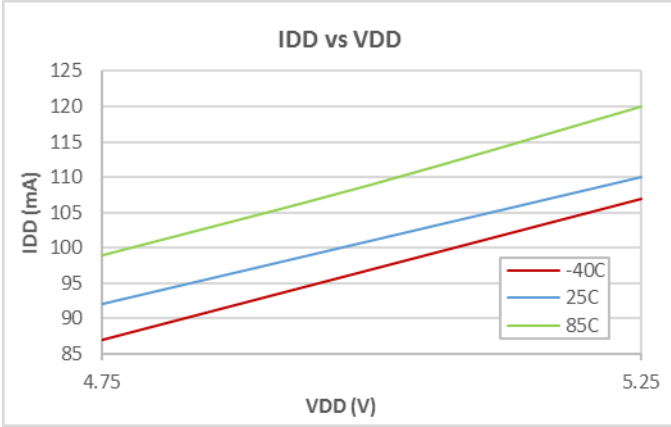

**Performance Data – Single Ended Configuration, 5V**

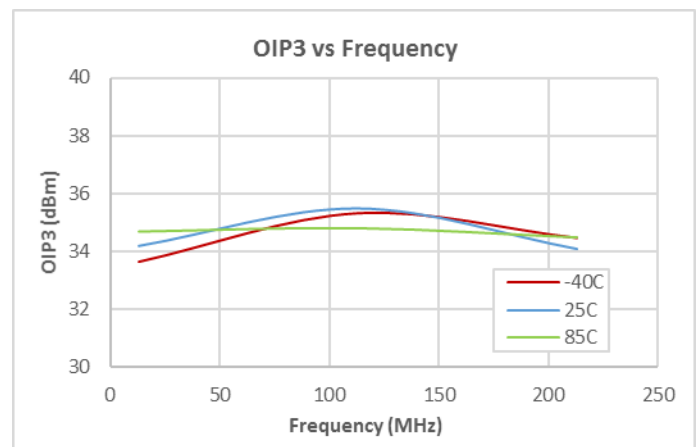
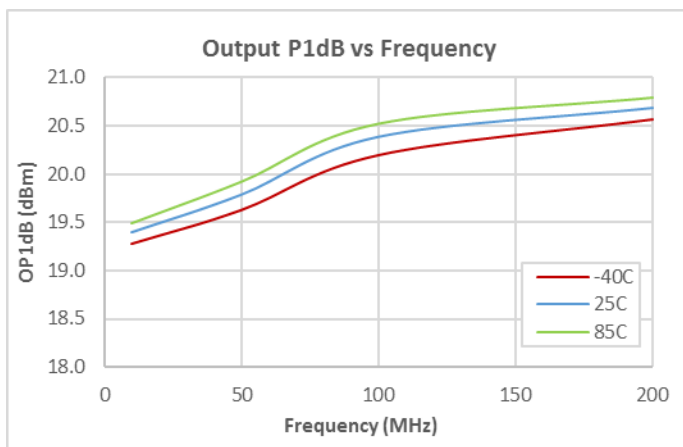
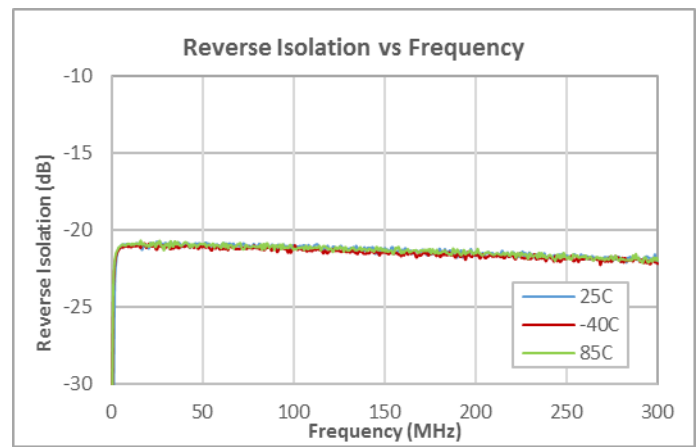
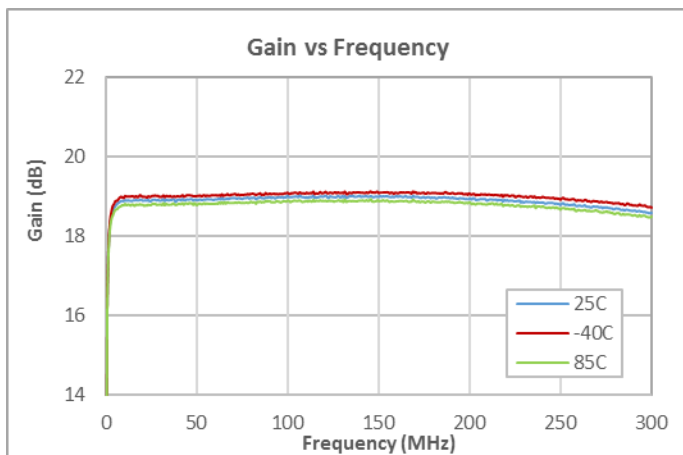
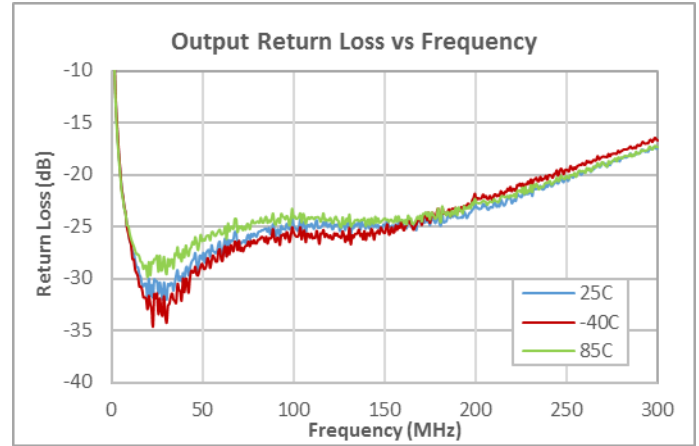

Notes:  
(1) OIP3: -3dBm/tone, F1 = 113MHz, F2 = 119MHz

### Performance Data – Single Ended Configuration, 5V

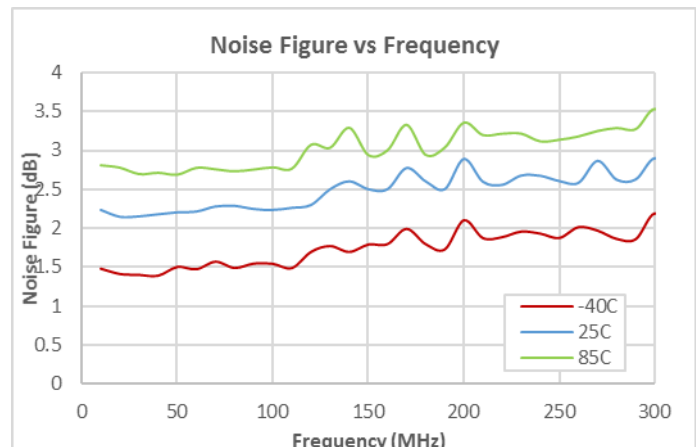
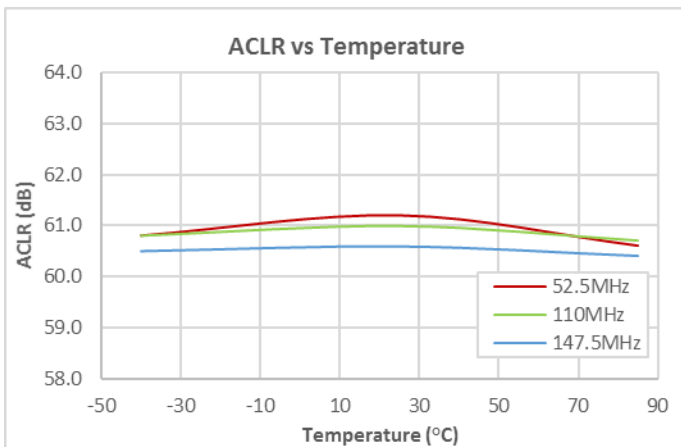
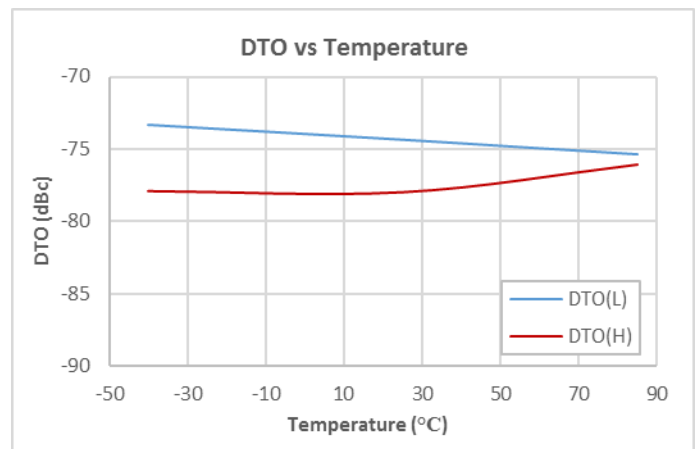
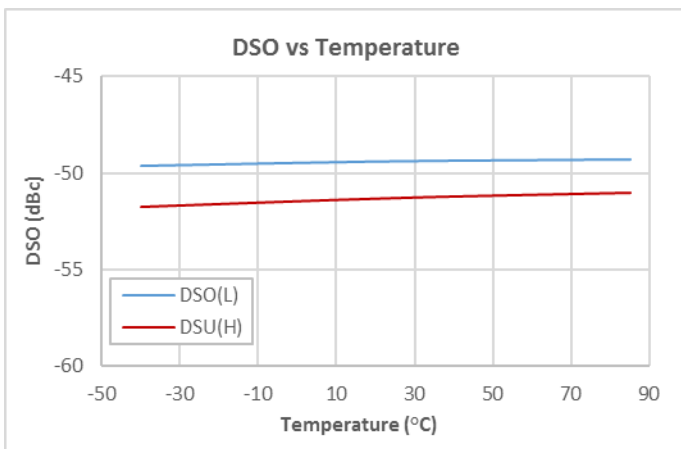
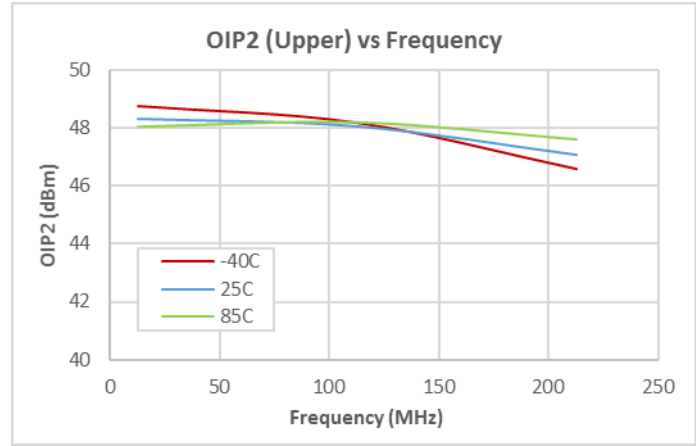
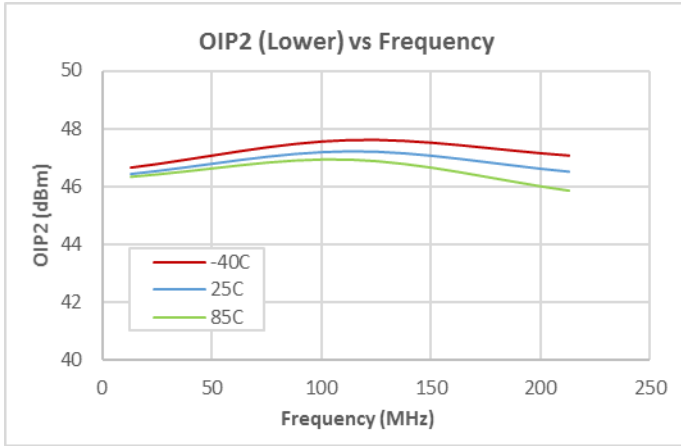

**Notes:**

- (1) OIP2: -3dBm/tone, F1 = 113MHz, F2 = 119MHz
- (2) DSO/DTO: f1=13MHz, f2=19MHz 46dBmV per tone
- (3) ACLR: Pout = 49dBmV, 5-195MHz OFDM w/ 9.6MHz exclusion band.



### Performance Data – Single Ended Configuration, 5V

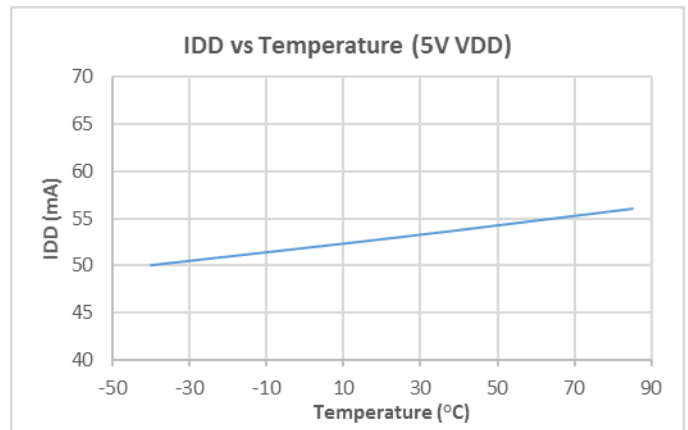
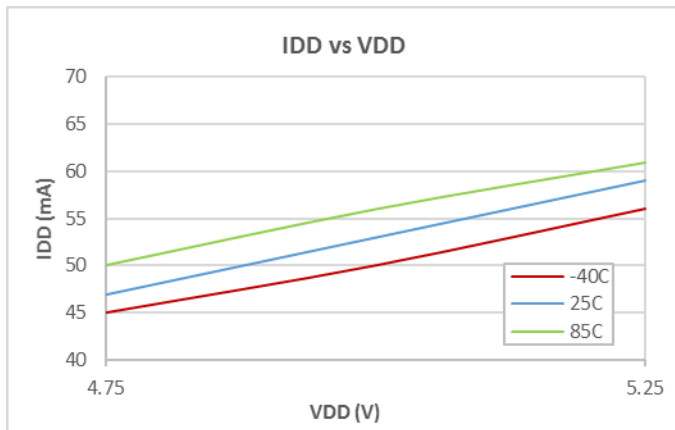

## Pad Configuration and Description

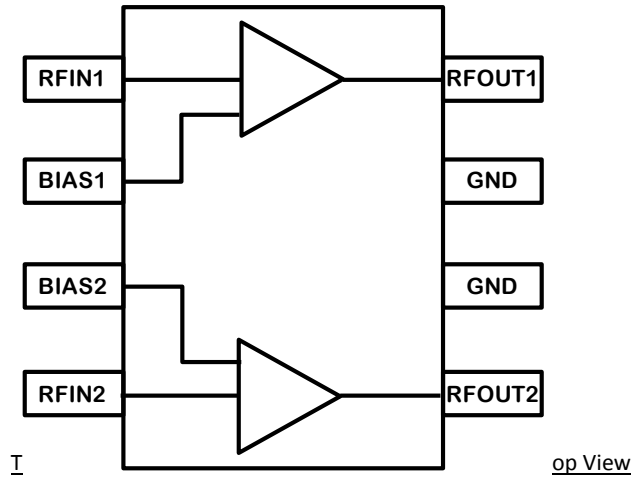

Pad No.	Label	Description
1	RFIN1	RF input for AMP1
2	BIAS1	AMP1 bias, requires choke to ground
3	BIAS2	AMP2 bias, requires choke to ground
4	RFIN2	RF input for AMP2
5	RFOUT2	RF output for AMP2
6	GND	Internally Not Connected
7	GND	Internally Not Connected
8	RFOUT1	RF output for AMP1
Backside Paddle	GND	Ground. Use recommended via pattern to minimize inductance and thermal resistance. See PCB Mounting Pattern for suggested footprint.

### Package Outline

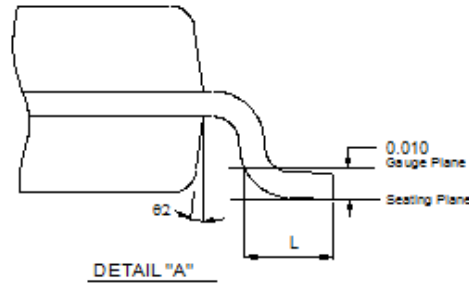
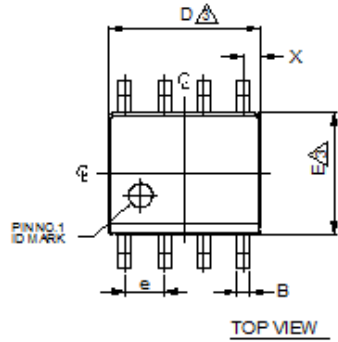

SYMBOL	8 SOIC	
	MIN	MAX
A	0.054	0.068
A1	0.001	0.004
B	0.014	0.019
D	0.189	0.196
E	0.150	0.157
H	0.229	0.244
M	0.087	0.097
N	0.082	0.092
e	0.050 BSC	
C	0.0075	0.0098
L	0.020	0.040
X	0.0215 REF	
61	0°	8°
62	7° BSC	

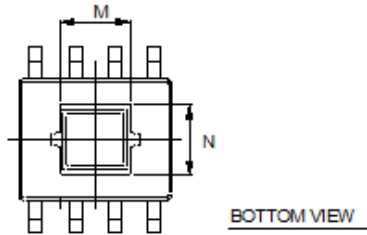
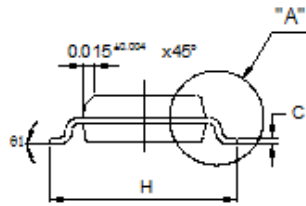
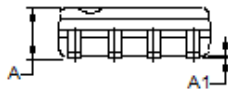

EXPOSED PADDLE

**NOTE:**

1. TOP PACKAGE SURFACE TO BE Ni, Pd, Au PLATING
2. BOTTOM PACKAGE SURFACE TO BE Ni, Pd, Au PLATING
3. DIMENSIONS ARE EXCLUSIVE MOLD FLASH AND GATE BURR.
4. FOOT LENGTH MEASURING IS BASED ON THE GAUGE PLANE METHOD.

**Notes:**

1. Dimensions in millimeters

## Package Marking

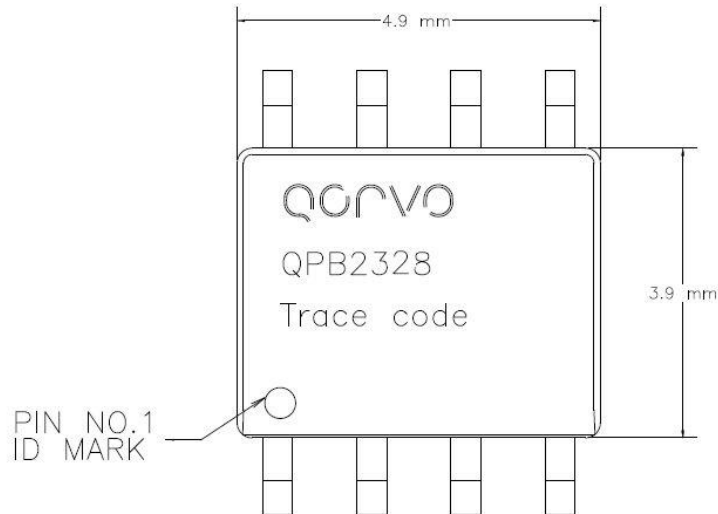

## Recommended Mounting Pattern

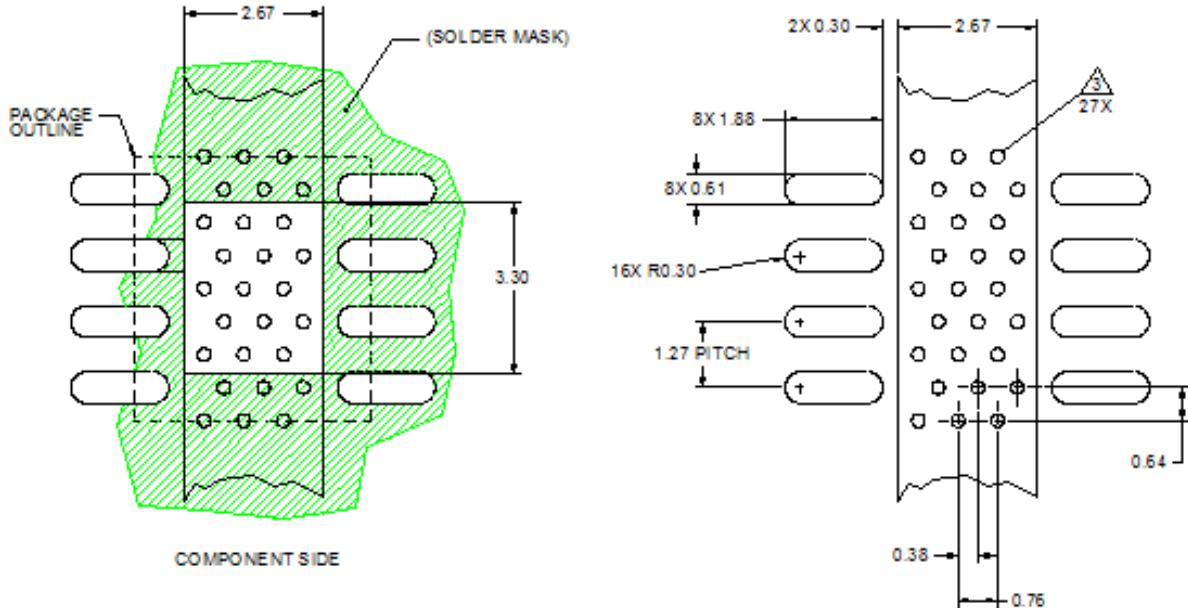

**Notes:**

1. All dimensions are in millimeters. Angles are in degrees.
2. Use 1oz. copper minimum for top and bottom layers
3. Vias are required under the backside paddle for proper RF/DC grounding and thermal dissipation. We recommend a 0.35mm (#80/0.135") diameter bit for drilling via holes and a final plated through diameter of 0.25mm (0.010").
4. Ensure good backside paddle solder attach for reliable operation and best electrical performance.

## Handling Precautions

Parameter	Rating	Standard
ESD – Human Body Model (HBM)	1B	ESDA / JEDEC JS-001-2012
ESD – Charged Device Model (CDM)	C3	JEDEC JESD22-C101F
MSL – Moisture Sensitivity Level	MSL3	IPC/JEDEC J-STD-020



Caution!  
ESD-Sensitive Device

## Solderability

Compatible with both lead-free (260°C max. reflow temp.) and tin/lead (245°C max. reflow temp.) soldering processes.

Solder profiles available upon request.

Contact plating: NiPdAu

## RoHS Compliance

This part is compliant with 2011/65/EU RoHS directive (Restrictions on the Use of Certain Hazardous Substances in Electrical and Electronic Equipment) as amended by Directive.

This product also has the following attributes:

- Lead Free
- Halogen Free (Chlorine, Bromine)
- Antimony Free
- TBBP-A (C<sub>15</sub>H<sub>12</sub>Br<sub>4</sub>O<sub>2</sub>) Free
- PFOS Free
- SVHC Free



## Contact Information

For the latest specifications, additional product information, worldwide sales and distribution locations:

**Tel: 1-844-890-8163**

**Web: [www.qorvo.com](http://www.qorvo.com)**

**Email: [customer.support@qorvo.com](mailto:customer.support@qorvo.com)**

## Important Notice

The information contained herein is believed to be reliable; however, Qorvo makes no warranties regarding the information contained herein and assumes no responsibility or liability whatsoever for the use of the information contained herein. All information contained herein is subject to change without notice. Customers should obtain and verify the latest relevant information before placing orders for Qorvo products. The information contained herein or any use of such information does not grant, explicitly or implicitly, to any party any patent rights, licenses, or any other intellectual property rights, whether with regard to such information itself or anything described by such information. **THIS INFORMATION DOES NOT CONSTITUTE A WARRANTY WITH RESPECT TO THE PRODUCTS DESCRIBED HEREIN, AND QORVO HEREBY DISCLAIMS ANY AND ALL WARRANTIES WITH RESPECT TO SUCH PRODUCTS WHETHER EXPRESS OR IMPLIED BY LAW, COURSE OF DEALING, COURSE OF PERFORMANCE, USAGE OF TRADE OR OTHERWISE, INCLUDING THE IMPLIED WARRANTIES OF MERCHANTABILITY AND FITNESS FOR A PARTICULAR PURPOSE.**

Without limiting the generality of the foregoing, Qorvo products are not warranted or authorized for use as critical components in medical, life-saving, or life-sustaining applications, or other applications where a failure would reasonably be expected to cause severe personal injury or death.

Copyright 2017 © Qorvo, Inc. | Qorvo is a registered trademark of Qorvo, Inc.



Компания «ЭлектроПласт» предлагает заключение долгосрочных отношений при поставках импортных электронных компонентов на взаимовыгодных условиях!

Наши преимущества:

- Оперативные поставки широкого спектра электронных компонентов отечественного и импортного производства напрямую от производителей и с крупнейших мировых складов;
- Поставка более 17-ти миллионов наименований электронных компонентов;
- Поставка сложных, дефицитных, либо снятых с производства позиций;
- Оперативные сроки поставки под заказ (от 5 рабочих дней);
- Экспресс доставка в любую точку России;
- Техническая поддержка проекта, помощь в подборе аналогов, поставка прототипов;
- Система менеджмента качества сертифицирована по Международному стандарту ISO 9001;
- Лицензия ФСБ на осуществление работ с использованием сведений, составляющих государственную тайну;
- Поставка специализированных компонентов (Xilinx, Altera, Analog Devices, Intersil, Interpoint, Microsemi, Aeroflex, Peregrine, Syfer, Eurofarad, Texas Instrument, Miteq, Cobham, E2V, MA-COM, Hittite, Mini-Circuits, General Dynamics и др.);

Помимо этого, одним из направлений компании «ЭлектроПласт» является направление «Источники питания». Мы предлагаем Вам помощь Конструкторского отдела:

- Подбор оптимального решения, техническое обоснование при выборе компонента;
- Подбор аналогов;
- Консультации по применению компонента;
- Поставка образцов и прототипов;
- Техническая поддержка проекта;
- Защита от снятия компонента с производства.



#### Как с нами связаться

**Телефон:** 8 (812) 309 58 32 (многоканальный)

**Факс:** 8 (812) 320-02-42

**Электронная почта:** [org@eplast1.ru](mailto:org@eplast1.ru)

**Адрес:** 198099, г. Санкт-Петербург, ул. Калинина, дом 2, корпус 4, литера А.