

General Specifications

Electrical Capacity (Resistive Load)

- For MRA:** 250mA @ 125V AC
For MRF or MRK: 0.4VA maximum @ 28V AC/DC maximum
 (Applicable Range 0.1mA ~ 0.1A @ 20mV ~ 28V)
 Note: Find additional explanation of operating range in Supplement section.

Other Ratings

- Contact Resistance:** 10 milliohms maximum for MRA; 50 milliohms maximum for MRF & MRK
Insulation Resistance: 100 megohms minimum @ 500V DC
Dielectric Strength: 1,000V AC minimum for 1 minute minimum for MRA
 500V AC minimum for 1 minute minimum for MRF & MRK
Mechanical Life: 30,000 operations minimum
Electrical Life: 10,000 operations minimum
Range of Operating Torque: 0.02 ~ 0.07Nm for MRA; 0.005 ~ 0.02Nm for MRF & MRK
Contact Timing: Nonshorting (break-before-make)
 MRA – self-cleaning, sliding contact; MRF & MRK – self-cleaning, rotary contactor disk
Indexing: 30°

Materials & Finishes

- Shaft:** Brass with nickel plating
Stopper Plate: Steel with zinc plating for MRA & MRK; polyamide cover with stopper for MRF
Bushing/Housing: Zinc alloy with zinc plating
Movable Contacts: Copper with silver plating for MRA; phosphor bronze with gold plating for MRF & MRK
End Contacts & Terminals: Brass with silver plating for MRA; phosphor bronze with gold plating for MRF & MRK
Common Contacts & Terminals: Brass with silver plating for MRA; phosphor bronze with gold plating for MRF & MRK
Base: Diallyl phthalate for MRA; fiberglass reinforced polyamide for MRF & MRK

Environmental Data

- Operating Temperature Range:** -10°C through +70°C (+14°F through +158°F)
Humidity: 90 ~ 95% humidity for 96 hours @ 40°C (104°F)
Vibration: 10 ~ 55Hz with peak-to-peak amplitude of 1.5mm traversing the frequency range & returning in 1 minute; 3 right angled directions for 2 hours
Shock: 50G (490m/s²) acceleration (tested in 3 right angled directions, with 3 shocks in each direction)
Sealing: MRK model meets IP67 of IEC60529 standards

Installation

- Mounting Torque:** .686Nm (6.08 lb•in)
Cap Installation Force: 19.6 ~ 29.4N (4.41 ~ 6.61 lbf) for MRA & MRK

Processing

- Soldering Time & Temperature:** Wave Soldering for MRA: See Profile A in Supplement section.
 Wave Soldering for MRF & MRK: See Profile B in Supplement section.
 Manual Soldering for MRA: See Profile A in Supplement section.
 Manual Soldering for MRF & MRK: See Profile B in Supplement section.
Cleaning: Automated cleaning recommended. Stopper plate, as well as washers for MRA & MRK, must be in place to maintain automated cleaning. See Cleaning specifications in Supplement section.

Standards & Certifications

MRA, MRF, & MRK models have not been tested for UL recognition or CSA certification. These switches are designed for use in a low-voltage, low-current, logic-level circuit. When used as intended in a logic-level circuit, the results do not produce hazardous energy.

Distinctive Characteristics

Low profile body of MRF model accommodates space limitations required for PCB mounting. For the MRA and MRK bushing mount models, the range of behind panel body depths is .323" to .669" (8.2mm to 17.0mm).

Positive detent mechanism for distinct feel and audible feedback.

Metal bushing and housing construction increases durability.

Adjustable stopper plate allows 2–12 position settings.

High contact reliability achieved by the self-cleaning contact mechanism.

Break-before-make contact timing with sliding contacts in MRA and rotary contactor disk in MRF and MRK models.

Interior housing seal and molded-in PC terminals, plus shaft rubber o-ring on MRA and MRK and polyamide cover on MRF model, allow cleaning after automated soldering.

MRK model meets IP67 of IEC60529 specifications (similar to NEMA 4 & 13).



Actual Size



Toggles

Rockers

Pushbuttons

Illuminated PB

Programmable

Keylocks

G Rotaries

Slides

Tactiles

Tilt

Touch

Indicators

Accessories

Supplement

TYPICAL SWITCH ORDERING EXAMPLE

MR

A

206

A



Actuators & Terminals

A	Shaft Actuated with PC Terminals
F	Low Profile Screwdriver Actuated with PC Terminals
K	Low Profile Shaft Actuated with PC Terminals

Poles & Circuits

112	SP with 2-12 Positions
206	DP with 2-6 Positions
403	4P with 2-3 Positions

Knobs

A	Plain Black
B	Small Color Tipped
C	Large Color Tipped

Colors

For Plain Knob	
No Code	Black
For Color Tipped	
A	Black
B	White
C	Red
E	Yellow
F	Green
G	Blue
H	Gray

DESCRIPTION FOR TYPICAL ORDERING EXAMPLE

MRA206-A

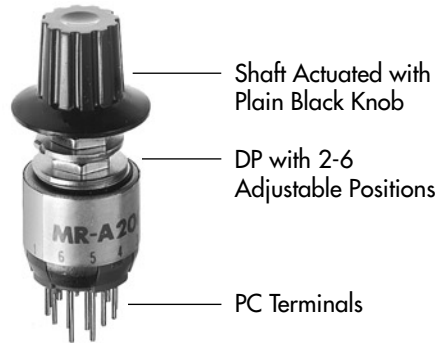

ACTUATORS & TERMINALS

A Shaft Actuated with PC Terminals



Shaft Terminal

F Low Profile Screwdriver Actuated with PC Terminals



Slotted for Screwdriver Terminal

K Low Profile Shaft Actuated with PC Terminals



Shaft Terminal

Toggles

Rockers

Pushbuttons

Illuminated PB

Programmable

Keylocks

Rotaries **G**

Slides

Tactiles

Tilt

Touch

Indicators

Accessories

Supplement

POLES & CIRCUITS					
Pole	Model	Number of Positions	Stopper Settings	Number of Terminals	Schematics
SP	MRA112	2-12	2, 3, 4, . . . 12	1 COM, 12 LOAD	
	MRF112	2-12	2, 3, 4, . . . 12	1 COM, 12 LOAD	
	MRK112	2-12	2, 3, 4, . . . 12	1 COM, 12 LOAD	
DP	MRA206	2-6	2, 3, 4, 5, 6	2 COM, 12 LOAD	
	MRF206	2-6	2, 3, 4, 5, 6	2 COM, 12 LOAD	
	MRK206	2-6	2, 3, 4, 5, 6	2 COM, 12 LOAD	
4P	MRA403	2-3	2, 3	4 COM, 12 LOAD	
	MRF403	2-3	2, 3	4 COM, 12 LOAD	
	MRK403	2-3	2, 3	4 COM, 12 LOAD	

POSITION SETTING FOR MRA, MRF, & MRK MODELS

Each switch is supplied with the stopper set for the maximum number of positions allowed for that model. Prior to installation, the desired position setting should be made. Contact factory for continuous rotation.

MRF Models

1. Remove the protective cover from the switch body.
2. Turn the shaft counterclockwise to the extreme left by using a screwdriver.
3. Inside the cover is a magnifying lens which would be positioned over the number which is to be the maximum position used; when the cover is then snapped into the switch, the projection beside the lens fits into the correct hole for setting the stop.



MRK & MRA Models

1. Using the actuator knob, turn the shaft counterclockwise to the extreme left. If the shaft is not turned counterclockwise to the extreme left, proper setting cannot be achieved. At this extreme position, the white line on the knob points to the number 1 position shown on the side of the switch.
2. Remove the knob from the shaft and loosen the nut far enough to allow raising the stopper plate, plus washer(s), for resetting to the desired position.
3. Note the position numbers on the side of the switch; these correspond to the terminal numbers and stopper holes. Insert the stopper in the hole numbered for the maximum desired number of stop settings. Satisfactory switch functioning cannot be assured if the stopper plate is not properly positioned.
4. Tighten the nut (beveled side up) firmly against the stopper plate.

Standard Mounting Hardware Packaged Loose with Each Switch:



Factory Assembled:

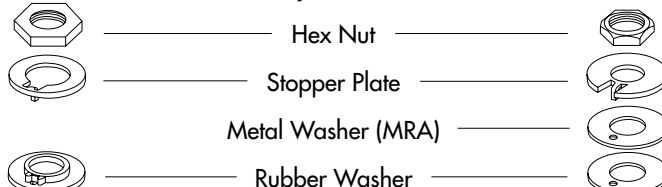

TYPICAL SWITCH DIMENSIONS

MRA • PC Terminals



MRA112

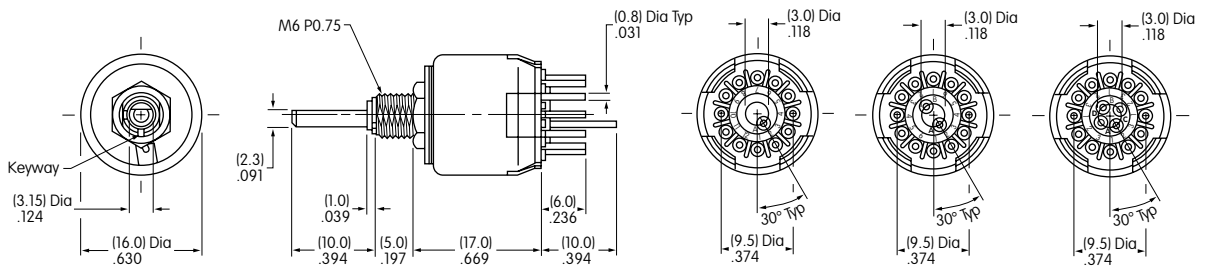

MRF • PC Terminals



MRF403

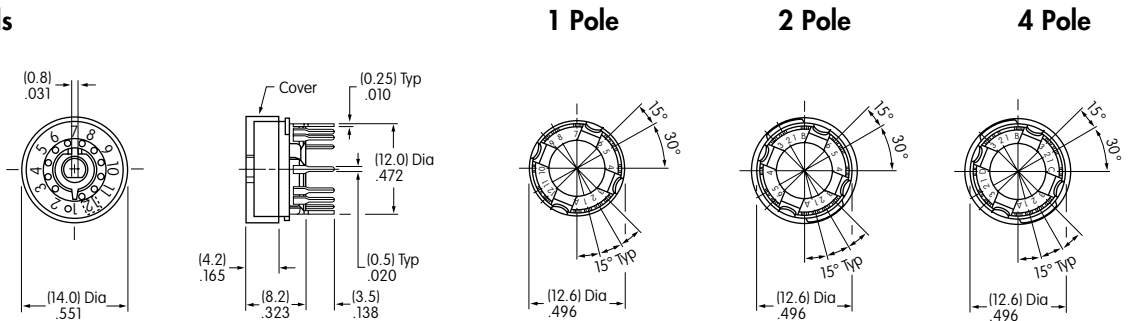

MRK • PC Terminals



MRK112

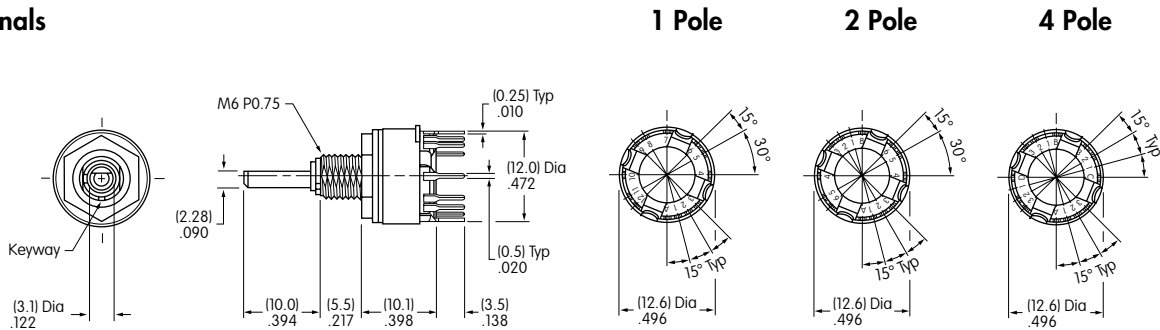

MRK devices are designed to be panel mounted. Installation without panel mounting will affect reliability.

FOOTPRINTS

Single Pole
MRA112

Double Pole
MRA206

Four Pole
MRA403

Single Pole
MRF112
MRK112

Double Pole
MRF206
MRK206

Four Pole
MRF403
MRK403

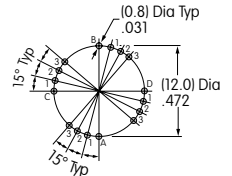
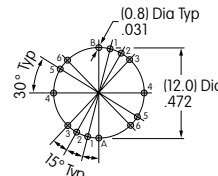
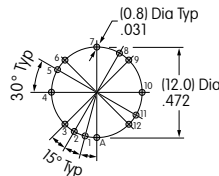
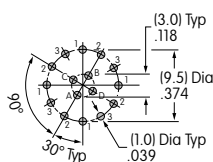
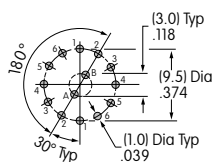
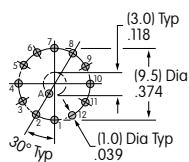

KNOBS

A AT433 Plain Black

Material:
Polyacetal

Color:
Black
only



B AT4103 Small Color Tipped

Base Material:
Polyester
Base Color:
Black

Polyamide Tip
Colors:
A, B, C, E, F, G, H



C AT4104 Large Color Tipped

Base Material:
Polyester
Base Color:
Black

Polyamide Tip
Colors:
A, B, C, E, F, G, H



Color Codes: **A** Black **B** White **C** Red **E** Yellow **F** Green **G** Blue **H** Gray

PANEL CUTOUTS & MAXIMUM EFFECTIVE PANEL THICKNESS

MRA & MRK

Nonsealed Panel

Without
Keyway

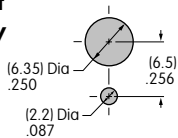

With
Keyway

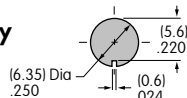

MRK

Sealed Panel

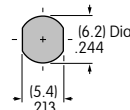

With Standard Hardware on Nonsealed Panel:
MRA .067" (1.7mm) MRK .087" (2.2mm)

Without Locking Ring on Nonsealed Panel:
MRA .098" (2.5mm) MRK .118" (3.0mm)

With AT513M & AT535 only on Sealed Panel:
MRK .106" (2.7mm)

STANDARD MOUNTING HARDWARE

AT513M Metric Hexagon Nut

Material:
Brass, nickel plating
1 for MRA; 1 for MRK

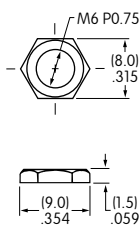

AT545 Locking Ring

Material:
Steel, chromate over zinc plating
1 for MRA; 1 for MRK

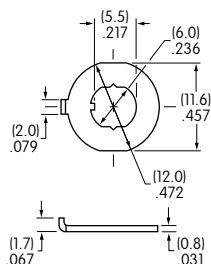

AT509 Lockwasher

Material:
Steel, chromate over zinc plating
1 for MRA; 1 for MRK

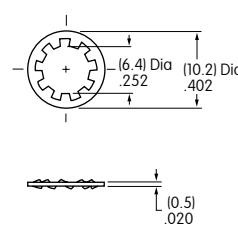

AT535 Rubber Ring

Material:
Nitrile butadiene rubber
1 for MRK

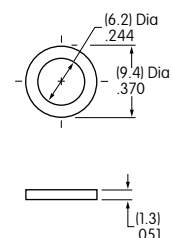

OPTIONAL SUPPORT BRACKET

AT543 Support Bracket for MRK

Material:
Steel with tin plating

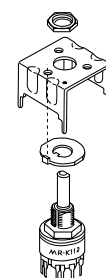
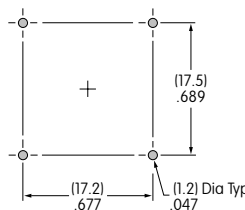
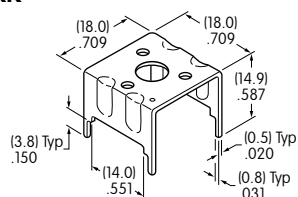

A support bracket is needed when the MRK is mounted only to a PC board and does not have the bushing through a panel.



Компания «ЭлектроПласт» предлагает заключение долгосрочных отношений при поставках импортных электронных компонентов на взаимовыгодных условиях!

Наши преимущества:

- Оперативные поставки широкого спектра электронных компонентов отечественного и импортного производства напрямую от производителей и с крупнейших мировых складов;
- Поставка более 17-ти миллионов наименований электронных компонентов;
- Поставка сложных, дефицитных, либо снятых с производства позиций;
- Оперативные сроки поставки под заказ (от 5 рабочих дней);
- Экспресс доставка в любую точку России;
- Техническая поддержка проекта, помощь в подборе аналогов, поставка прототипов;
- Система менеджмента качества сертифицирована по Международному стандарту ISO 9001;
- Лицензия ФСБ на осуществление работ с использованием сведений, составляющих государственную тайну;
- Поставка специализированных компонентов (Xilinx, Altera, Analog Devices, Intersil, Interpoint, Microsemi, Aeroflex, Peregrine, Syfer, Eurofarad, Texas Instrument, Miteq, Cobham, E2V, MA-COM, Hittite, Mini-Circuits, General Dynamics и др.);

Помимо этого, одним из направлений компании «ЭлектроПласт» является направление «Источники питания». Мы предлагаем Вам помощь Конструкторского отдела:

- Подбор оптимального решения, техническое обоснование при выборе компонента;
- Подбор аналогов;
- Консультации по применению компонента;
- Поставка образцов и прототипов;
- Техническая поддержка проекта;
- Защита от снятия компонента с производства.



Как с нами связаться

Телефон: 8 (812) 309 58 32 (многоканальный)

Факс: 8 (812) 320-02-42

Электронная почта: org@eplast1.ru

Адрес: 198099, г. Санкт-Петербург, ул. Калинина, дом 2, корпус 4, литера А.