

General Specifications

Electrical Capacity (Resistive Load)

Logic Level: 0.4VA maximum @ 28V AC/DC maximum
(Applicable Range 0.1mA ~ 0.1A @ 20mV ~ 28V)
Note: Find additional explanation of operating range in Supplement section.

Other Ratings

Contact Resistance: 50 milliohms maximum
Insulation Resistance: 1,000 megohms minimum @ 500V DC
Dielectric Strength: 1,000V AC minimum between contacts for 1 minute minimum;
1,500V AC minimum between contacts & case for 1 minute minimum

Mechanical Life: 200,000 operations minimum
Electrical Life: 100,000 operations minimum
Nominal Operating Force: Single Pole: 1.96N
Double Pole: 2.94N
Travel: Pretravel .020" (0.5mm); Overtravel .020" (0.5mm); Total Travel .039" (1.0mm)

Materials & Finishes

Plunger: Brass with nickel plating
Bushing: Brass with nickel plating
Frame: Stainless steel
Case: Glass fiber reinforced polyamide
Movable Contacts: Copper with gold plating
Stationary Contacts: Phosphor bronze with gold plating
Terminals: Brass with gold plating

Environmental Data

Operating Temp Range: -10°C through +70°C (+14°F through +158°F)
Humidity: 90 ~ 95% humidity for 96 hours @ 40°C (104°F)
Vibration: 10 ~ 55Hz with peak-to-peak amplitude of 1.5mm traversing the frequency range & returning in 1 minute; 3 right angled directions for 2 hours
Shock: 50G (490m/s²) acceleration (tested in 6 right angled directions, with 5 shocks in each direction)

Installation

Mounting Torque: 1.47Nm (13.0 lb•in) for double nut; 0.68Nm (6.0 lb•in) for single nut
Cap Installation Force: 78.5N (17.65 lbf) maximum downward force on actuator

PCB Processing

Soldering: Wave Soldering Recommended. See Profile A in Supplement section.
Manual Soldering: See Profile B in Supplement section.
Cleaning: These devices are not process sealed. Hand clean locally using alcohol based solution.

Standards & Certifications

The DB Series pushbuttons have not been tested for UL recognition or CSA certification. These switches are designed for use in low-voltage, low-current, logic-level circuit. When used as intended in a logic-level circuit, the results do not produce hazardous energy.

Distinctive Characteristics

Both PCB and panel mounting options available.

Choice of cap sizes in .315" (8.0mm) and .394" (10.0mm) diameter cap design for simple, snap-on installation.

High torque bushing prevents rotation and separation from metal frame during installation.

Stainless steel frame resists corrosion.

Snap action contacts give smooth actuation, short stroke, light touch, and audible feedback. This mechanism also provides long mechanical life.

Molded-in terminals prevent entry of solder flux, dust, and other contaminants.

.100" x .100" (2.54mm x 2.54mm) terminal spacing conforms to standard PC board grid spacing. Round terminals for easier through-hole mounting on PC boards.

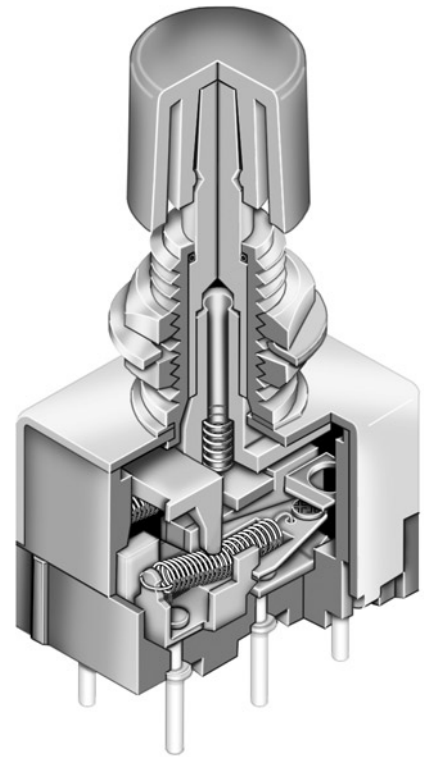

Actual Size

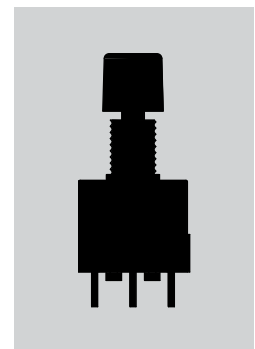

Toggle

Rockers

C Pushbuttons

Illuminated PB

Programmable

Keylocks

Rotaries

Slides

Tactiles

Tilt

Touch

Indicators

Accessories

Supplement

TYPICAL SWITCH ORDERING EXAMPLE

DB25

21

B

Poles & Circuits

11	SPDT	ON	(ON)
21	DPDT	ON	(ON)

() = Momentary

PC Terminals



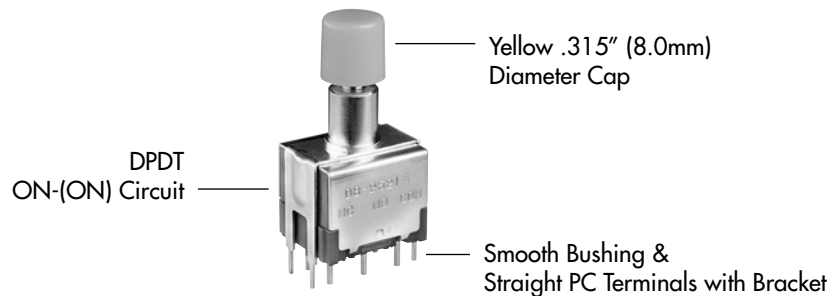

Threaded Bushing	
P	Straight
Smooth Bushing	
B	Straight with Bracket
H	Right Angle with Bracket
V	Vertical with Bracket

DESCRIPTION FOR TYPICAL ORDERING EXAMPLE

DB2521B with AT443E Cap

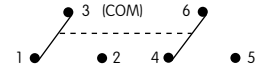

POLES & CIRCUITS

		Plunger Position () = Momentary		Connected Terminals		Throw & Switch Schematics
Pole	Model	Normal 	Down 	Normal 	Down 	
SP	DB2511	ON	(ON)	3-1	3-2	SPDT 
DP	DB2521	ON	(ON)	3-1 6-4	3-2 6-5	DPDT 

Note: Terminal numbers are not actually on the switch.

TYPICAL SWITCH DIMENSIONS

Single Pole

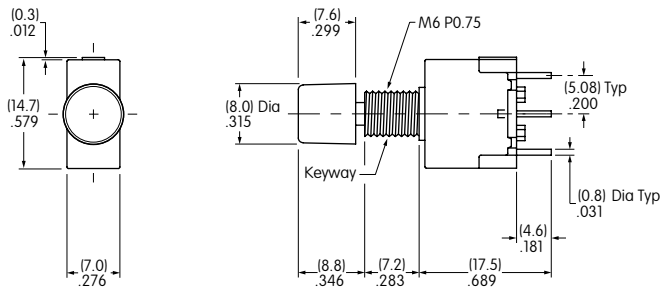

Straight PC

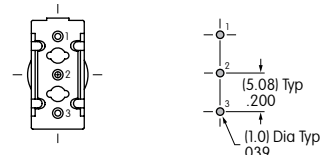

DB2511P with AT443C

Double Pole

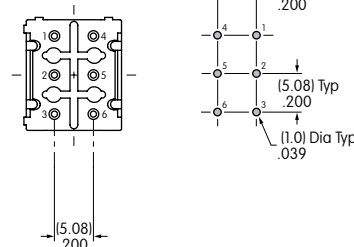
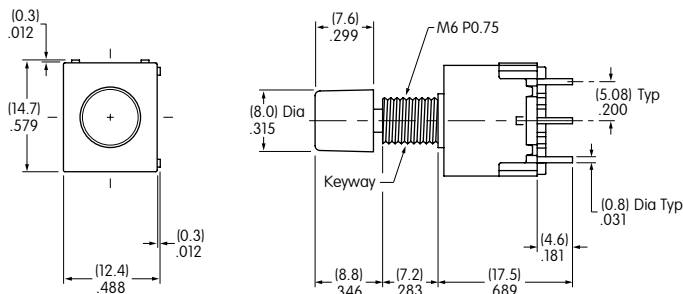

DB2521P with AT442A

Single Pole

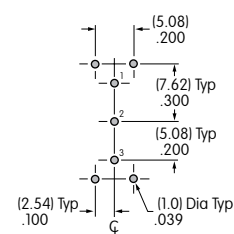
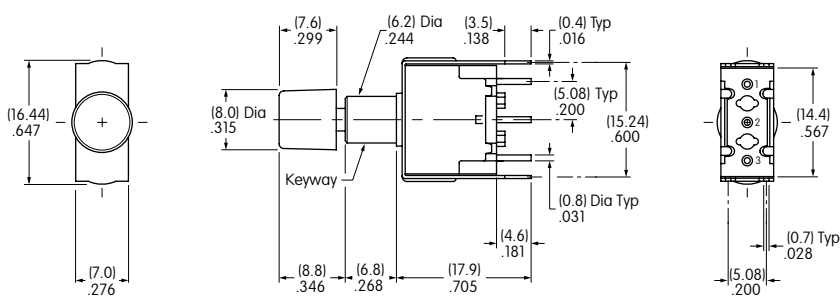

DB2511B with AT442C

Double Pole

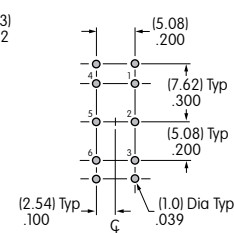
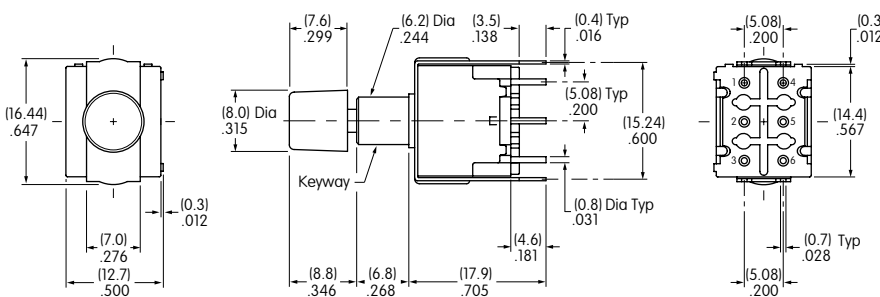

DB2521B with AT443E

TYPICAL SWITCH DIMENSIONS

Right Angle PC with Bracket

Single Pole

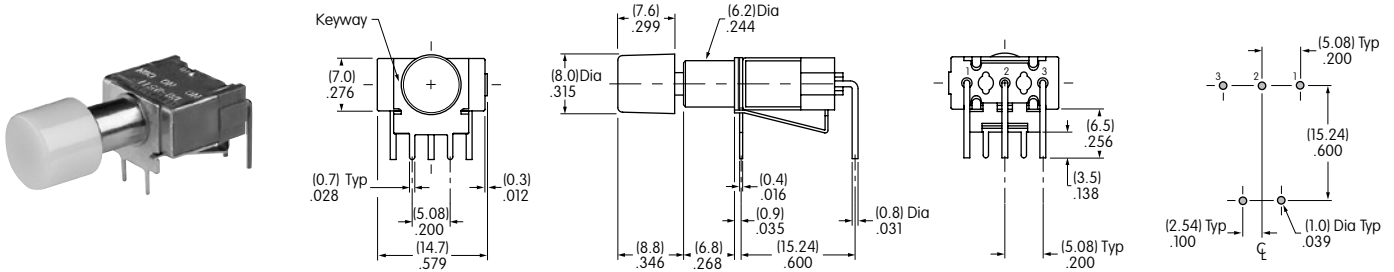

DB2511H with AT442B

Right Angle PC with Bracket

Double Pole

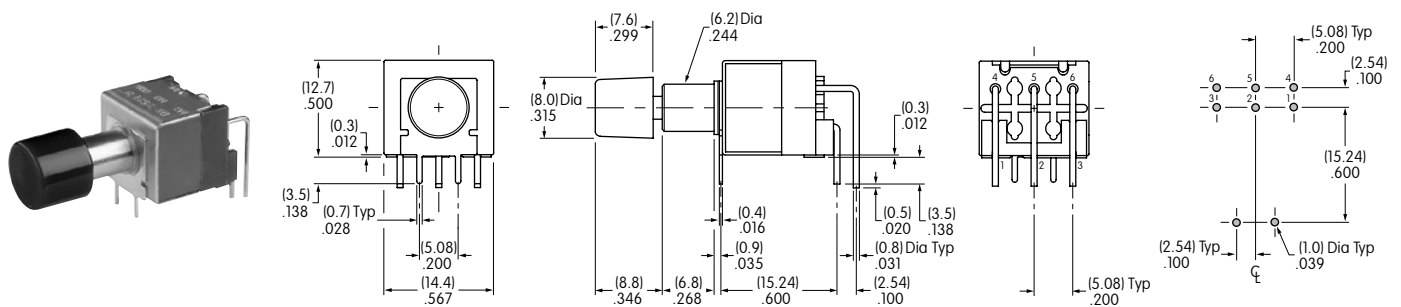

DB2521H with AT442A

Vertical PC with Bracket

Single Pole

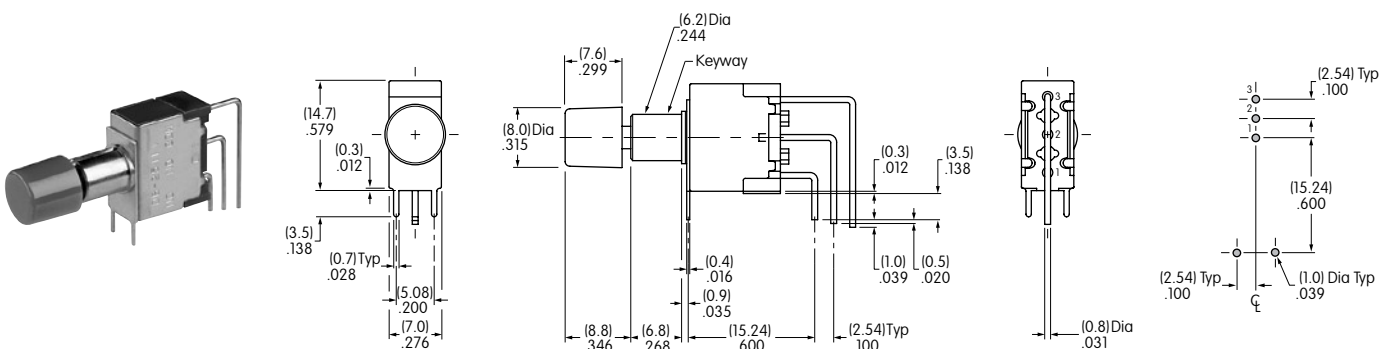

DB2511V with AT443C

Vertical PC with Bracket

Double Pole

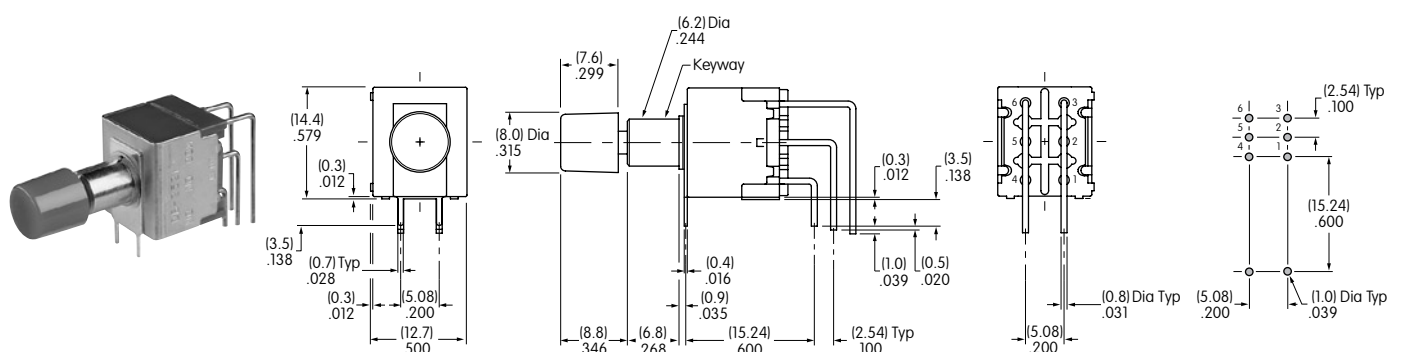

DB2521V with AT443C

OPTIONAL CAPS & COLORS

AT443 .315" (8.0mm) Diameter Snap-on Cap

Cap Colors Available:

- | | |
|----------------|-----------------|
| A Black | E Yellow |
| B White | F Green |
| C Red | G Blue |

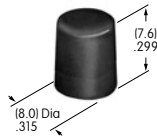

Cap Material: Polycarbonate Finish: Glossy

AT442 .394" (10.0mm) Diameter Snap-on Cap

Cap Colors Available:

- | | |
|----------------|-----------------|
| A Black | E Yellow |
| B White | F Green |
| C Red | G Blue |

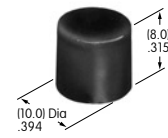

Cap Material: Polycarbonate Finish: Glossy

HARDWARE

Standard Hardware

AT513M Metric Hexagon Nut

Material:
Brass with
Nickel Plating

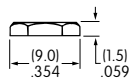
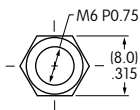

AT509 Lockwasher

Material:
Steel with
Zinc/Chromate

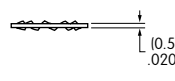
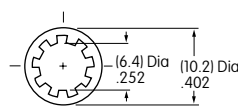

Optional Hardware

AT507M Metric Locking Ring

Material:
Steel with
Zinc/Chromate

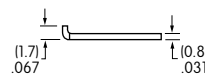
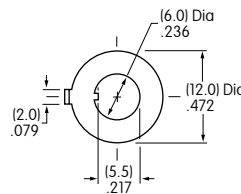

AT501M Metric Knurled Face Nut

Material:
Brass with
Chrome Plating

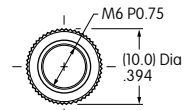

INSTALLATION/ASSEMBLY

- 2 AT513M Metric Hexagon Nuts
- 1 AT509 Internal Tooth Lockwasher

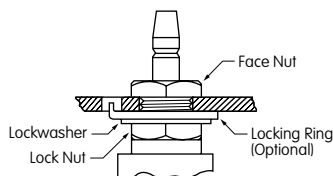

Optional Hardware:
AT507M Metric Locking Ring

Note: Cap must be snapped on after the switch is mounted into the panel.

PANEL CUTOUTS & THICKNESSES

With Standard Hardware

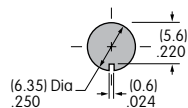

Maximum Effective Panel Thickness:
.118" (3.0mm)

Without Bottom Hex Nut

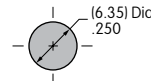

Maximum Effective Panel Thickness:
.185" (4.7mm)

With Standard Hardware & Optional Locking Ring

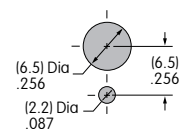

Maximum Effective Panel Thickness:
.087" (2.2mm)



Компания «ЭлектроПласт» предлагает заключение долгосрочных отношений при поставках импортных электронных компонентов на взаимовыгодных условиях!

Наши преимущества:

- Оперативные поставки широкого спектра электронных компонентов отечественного и импортного производства напрямую от производителей и с крупнейших мировых складов;
- Поставка более 17-ти миллионов наименований электронных компонентов;
- Поставка сложных, дефицитных, либо снятых с производства позиций;
- Оперативные сроки поставки под заказ (от 5 рабочих дней);
- Экспресс доставка в любую точку России;
- Техническая поддержка проекта, помощь в подборе аналогов, поставка прототипов;
- Система менеджмента качества сертифицирована по Международному стандарту ISO 9001;
- Лицензия ФСБ на осуществление работ с использованием сведений, составляющих государственную тайну;
- Поставка специализированных компонентов (Xilinx, Altera, Analog Devices, Intersil, Interpoint, Microsemi, Aeroflex, Peregrine, Syfer, Eurofarad, Texas Instrument, Miteq, Cobham, E2V, MA-COM, Hittite, Mini-Circuits, General Dynamics и др.);

Помимо этого, одним из направлений компании «ЭлектроПласт» является направление «Источники питания». Мы предлагаем Вам помощь Конструкторского отдела:

- Подбор оптимального решения, техническое обоснование при выборе компонента;
- Подбор аналогов;
- Консультации по применению компонента;
- Поставка образцов и прототипов;
- Техническая поддержка проекта;
- Защита от снятия компонента с производства.



Как с нами связаться

Телефон: 8 (812) 309 58 32 (многоканальный)

Факс: 8 (812) 320-02-42

Электронная почта: org@eplast1.ru

Адрес: 198099, г. Санкт-Петербург, ул. Калинина, дом 2, корпус 4, литера А.