

3A, 45V - 60V Trench Schottky Rectifier

FEATURES

- Patented Trench Schottky technology
- Excellent high temperature stability
- Low forward voltage
- Lower power loss/ high efficiency
- High forward surge capability
- Compliant to RoHS Directive 2011/65/EU and in accordance to WEEE 2002/96/EC
- Halogen-free according to IEC 61249-2-21

APPLICATIONS

- Trench Schottky barrier rectifier is designed for high frequency miniature switched mode power supplies such as adapters, lighting and on-board DC/DC converters

MECHANICAL DATA

- Case: SOD-123HE
- Molding compound meets UL 94V-0 flammability rating
- Part no. with suffix "H" means AEC-Q101 qualified
- Packing code with suffix "G" means green compound (halogen-free)
- Moisture sensitivity level: level 1, per J-STD-020
- Terminal: Matte tin plated leads, solderable per J-STD-002
- Meet JESD 201 class 2 whisker test
- Polarity: As marked
- Weight: 0.022g (approximately)

KEY PARAMETERS		
PARAMETER	VALUE	UNIT
$I_{F(AV)}$	3	A
V_{RRM}	45 - 60	V
I_{FSM}	60	A
$T_{J\ MAX}$	150	°C
Package	SOD-123HE	
Configuration	Single die	

SOD-123HE

ABSOLUTE MAXIMUM RATINGS ($T_A = 25^\circ\text{C}$ unless otherwise noted)				
PARAMETER	SYMBOL	TSSE3H45	TSSE3H60	UNIT
Marking code on the device		E3H45	E3H60	
Maximum repetitive peak reverse voltage	V_{RRM}	45	60	V
Maximum RMS voltage	V_{RMS}	32	42	V
Forward current	$I_{F(AV)}$	3		A
Surge peak forward current, 8.3 ms single half sine-wave superimposed on rated load per diode	I_{FSM}	60		A
Junction temperature	T_J	-55 to +150		°C
Storage temperature	T_{STG}	-55 to +150		°C

THERMAL PERFORMANCE			
PARAMETER	SYMBOL	LIMIT	UNIT
Junction-to-lead thermal resistance per diode	$R_{\theta JL}$	20	°C/W

ELECTRICAL SPECIFICATIONS ($T_A = 25^\circ\text{C}$ unless otherwise noted)						
PARAMETER		CONDITIONS	SYMBOL	TYP	MAX	UNIT
Forward voltage per diode ⁽¹⁾	TSSE3H45	$I_F = 3\text{A}, T_J = 25^\circ\text{C}$	V_F	0.47	0.57	V
		$I_F = 3\text{A}, T_J = 125^\circ\text{C}$		0.40	0.50	V
	TSSE3H60	$I_F = 3\text{A}, T_J = 25^\circ\text{C}$		0.50	0.60	V
		$I_F = 3\text{A}, T_J = 125^\circ\text{C}$		0.43	0.53	V
Reverse current @ rated V_R per diode ⁽²⁾		$T_J = 25^\circ\text{C}$	I_R	-	100	μA
		$T_J = 125^\circ\text{C}$		-	25	mA

Notes:

1. Pulse test with $PW=0.3$ ms
2. Pulse test with $PW=30$ ms

ORDERING INFORMATION					
PART NO.	PART NO. SUFFIX	PACKING CODE	PACKING CODE SUFFIX	PACKAGE	PACKING
TSSE3Hxx (Note 1, 2)	H	RV	G	SOD-123HE	3,000 / 7" Reel
		RQ		SOD-123HE	10,000 / 13" Reel

Notes:

1. "x" defines voltage from 45V (TSSE3H45) to 60V (TSSE3H60)
2. Whole series with green compound (halogen-free)

EXAMPLE P/N					
EXAMPLE P/N	PART NO.	PART NO. SUFFIX	PACKING CODE	PACKING CODE SUFFIX	DESCRIPTION
TSSE3H45HRVG	TSSE3H45	H	RV	G	AEC-Q101 qualified Green compound

CHARACTERISTICS CURVES

($T_A = 25^\circ\text{C}$ unless otherwise noted)

Fig.1 Forward Current Derating Curve

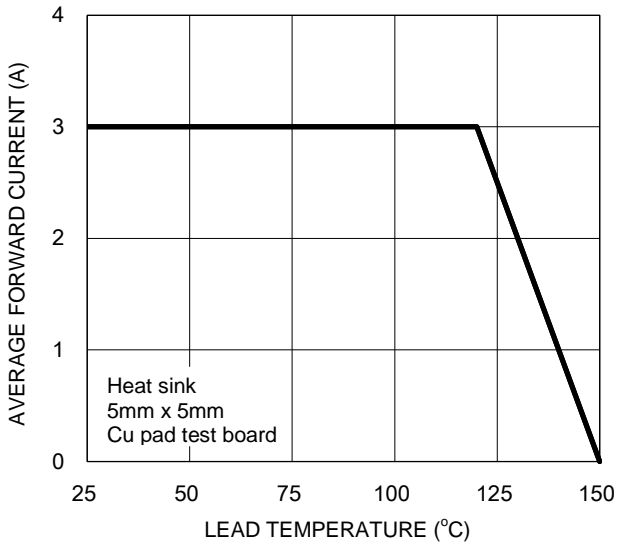

Fig.2 Typical Junction Capacitance

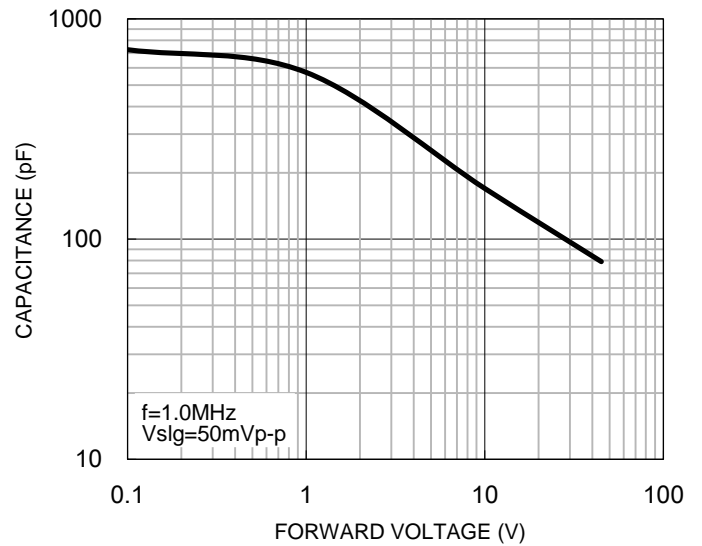

Fig.3 Typical Reverse Characteristics

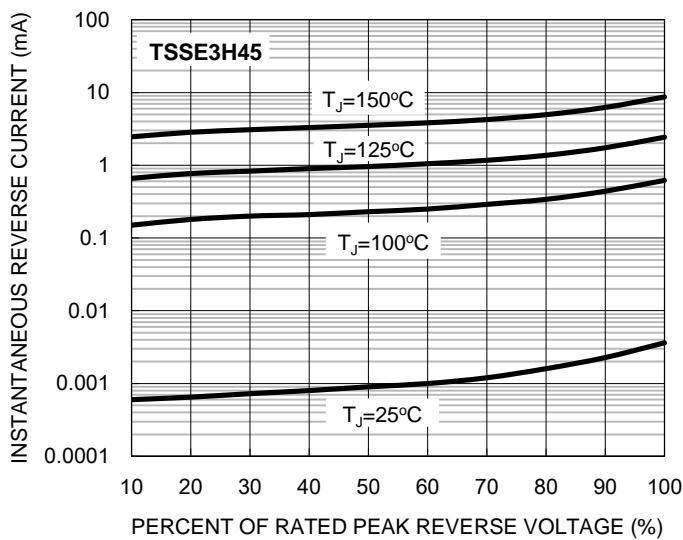
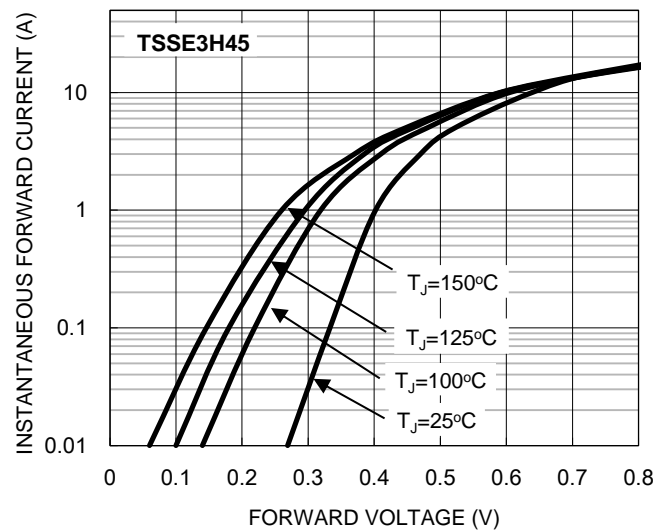

Fig.4 Typical Forward Characteristics



CHARACTERISTICS CURVES

($T_A = 25^\circ\text{C}$ unless otherwise noted)

Fig.5 Typical Reverse Characteristics

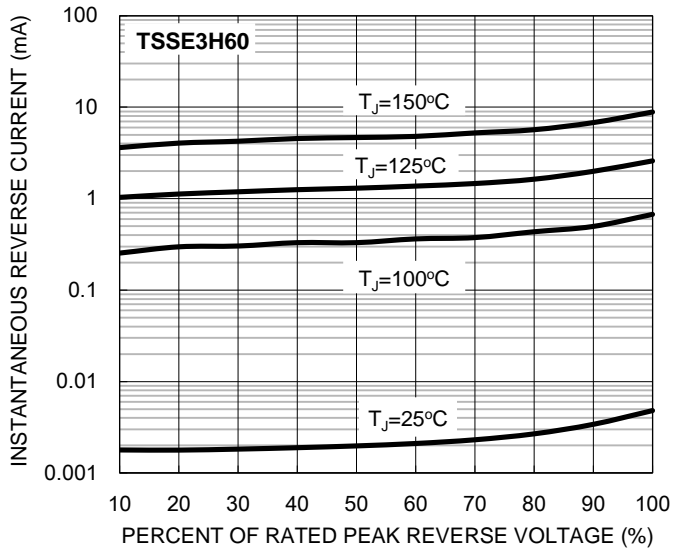
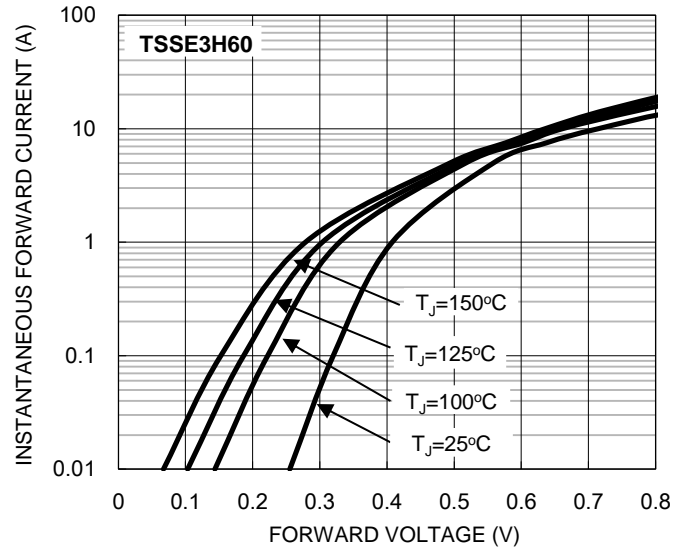
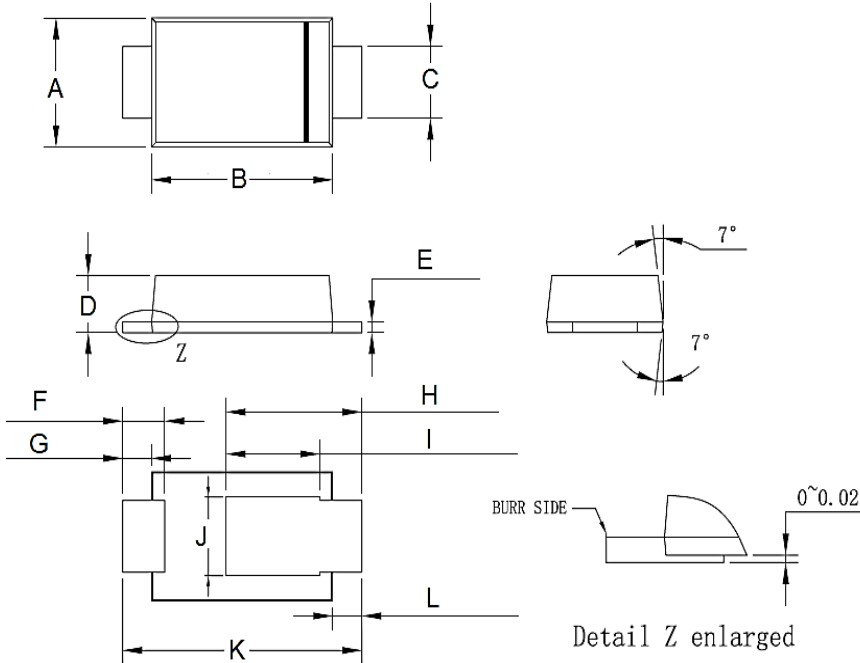

Fig.6 Typical Forward Characteristics



PACKAGE OUTLINE DIMENSIONS

SOD-123HE



DIM.	Unit (mm)		Unit (inch)	
	Min	Max	Min	Max
A	1.65	1.95	0.065	0.077
B	2.60	3.00	0.102	0.118
C	0.85	1.15	0.033	0.045
D	0.75	0.85	0.030	0.033
E	0.10	0.20	0.004	0.008
F	0.55	0.75	0.022	0.030
G	0.35	0.55	0.014	0.022
H	1.90	2.30	0.075	0.091
I	1.35	1.55	0.053	0.061
J	0.95	1.25	0.037	0.049
K	3.50	3.90	0.138	0.154
L	0.35	0.55	0.014	0.022

SUGGESTED PAD LAYOUT

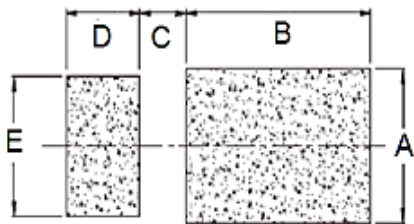

Symbol	Unit (mm)	Unit (inch)
A	1.40	0.055
B	2.40	0.094
C	0.70	0.028
D	0.90	0.035
E	1.40	0.055

MARKING DIAGRAM



P/N = Marking Code
YW = Date Code
F = Factory Code

Notice

Specifications of the products displayed herein are subject to change without notice. TSC or anyone on its behalf, assumes no responsibility or liability for any errors or inaccuracies.

Information contained herein is intended to provide a product description only. No license, express or implied, to any intellectual property rights is granted by this document. Except as provided in TSC's terms and conditions of sale for such products, TSC assumes no liability whatsoever, and disclaims any express or implied warranty, relating to sale and/or use of TSC products including liability or warranties relating to fitness for a particular purpose, merchantability, or infringement of any patent, copyright, or other intellectual property right.

The products shown herein are not designed for use in medical, life-saving, or life-sustaining applications. Customers using or selling these products for use in such applications do so at their own risk and agree to fully indemnify TSC for any damages resulting from such improper use or sale.



Компания «ЭлектроПласт» предлагает заключение долгосрочных отношений при поставках импортных электронных компонентов на взаимовыгодных условиях!

Наши преимущества:

- Оперативные поставки широкого спектра электронных компонентов отечественного и импортного производства напрямую от производителей и с крупнейших мировых складов;
- Поставка более 17-ти миллионов наименований электронных компонентов;
- Поставка сложных, дефицитных, либо снятых с производства позиций;
- Оперативные сроки поставки под заказ (от 5 рабочих дней);
- Экспресс доставка в любую точку России;
- Техническая поддержка проекта, помощь в подборе аналогов, поставка прототипов;
- Система менеджмента качества сертифицирована по Международному стандарту ISO 9001;
- Лицензия ФСБ на осуществление работ с использованием сведений, составляющих государственную тайну;
- Поставка специализированных компонентов (Xilinx, Altera, Analog Devices, Intersil, Interpoint, Microsemi, Aeroflex, Peregrine, Syfer, Eurofarad, Texas Instrument, Miteq, Cobham, E2V, MA-COM, Hittite, Mini-Circuits, General Dynamics и др.);

Помимо этого, одним из направлений компании «ЭлектроПласт» является направление «Источники питания». Мы предлагаем Вам помощь Конструкторского отдела:

- Подбор оптимального решения, техническое обоснование при выборе компонента;
- Подбор аналогов;
- Консультации по применению компонента;
- Поставка образцов и прототипов;
- Техническая поддержка проекта;
- Защита от снятия компонента с производства.



Как с нами связаться

Телефон: 8 (812) 309 58 32 (многоканальный)

Факс: 8 (812) 320-02-42

Электронная почта: org@eplast1.ru

Адрес: 198099, г. Санкт-Петербург, ул. Калинина, дом 2, корпус 4, литера А.