

# Powerpole® Connectors

## - PP15 to PP45 :

### up to 55 Amps

PP15-45 series are the smallest Powerpole® housings. They can be used for wire-to-wire or wire-to-board applications. Wire sizes from #20 AWG (0.75 mm<sup>2</sup>) to #10 (6 mm<sup>2</sup>) offer power capabilities up to 55 amps per pole. Finger proof housings and the ability to incorporate first-mate last-break ground connectors enhance the capabilities of this Powerpole® series.

#### High Power Density

- Up to 55 amps in a compact footprint

#### Wire-to Wire & Wire-to-Board Configurations

- Wire & PCB contacts can be used in the same housings

#### Finger Proof Housings Available

- Protects against accidental contact with live circuits

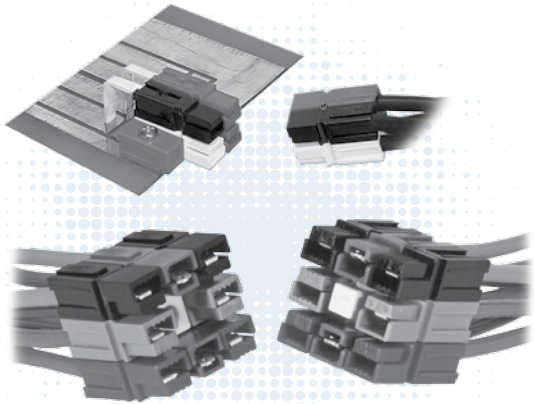

SECTION 2  
Powerpole® PP15 to 45

## | PP15-45 ORDERING INFORMATION |

### PP15-45 Finger Proof Housings

Improved on the original APP® design by adding ribs to mating interface to protect against accidental contact with live circuits. Meets the requirements of UL1977 section 10.2 and is rated IP20. Will not mate with standard housings.

| Description          | Part Numbers |           |
|----------------------|--------------|-----------|
| Minimum Quantity ... | 2,500        | 200       |
| Red                  | 1327FP-BK    | 1327FP    |
| Green                | 1327G5FP-BK  | 1327G5FP  |
| Black                | 1327G6FP-BK  | 1327G6FP  |
| White                | 1327G7FP-BK  | 1327G7FP  |
| Blue                 | 1327G8FP-BK  | 1327G8FP  |
| Yellow               | 1327G16FP-BK | 1327G16FP |

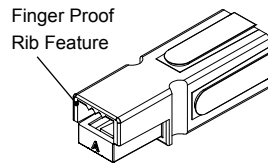

PP15-45 Finger Proof & Standard & Ground Housing Dimensions

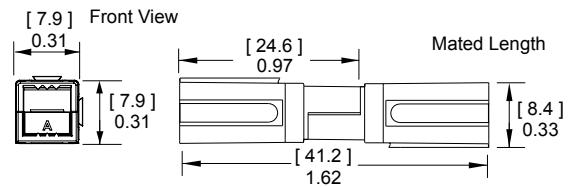

### PP15-45 Standard Housings

The original housing design has an open interface and is available in a wide array of colors. Will not mate with finger proof housings.

| Description          | Part Numbers |         |
|----------------------|--------------|---------|
| Minimum Quantity ... | 2,500        | 200     |
| Red                  | 1327-BK      | 1327    |
| Green                | 1327G5-BK    | 1327G5  |
| Black                | 1327G6-BK    | 1327G6  |
| White                | 1327G7-BK    | 1327G7  |
| Blue                 | 1327G8-BK    | 1327G8  |
| Yellow               | 1327G16-BK   | 1327G16 |
| Orange               | 1327G17-BK   | 1327G17 |
| Gray                 | 1327G18-BK   | 1327G18 |
| Brown                | 1327G21-BK   | 1327G21 |
| Pink                 | 1327G22-BK   | 1327G22 |
| Purple               | 1327G23-BK   | 1327G23 |

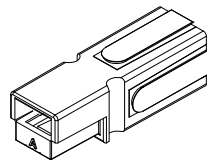

### 45A Premate Ground Housings

Green housings are keyed to prevent accidental mating with standard or finger proof Powerpole® housings.

| Description          | Part Number |        |
|----------------------|-------------|--------|
| Minimum Quantity ... | 2,500       | 200    |
| Green                | 1827G1-BK   | 1827G1 |

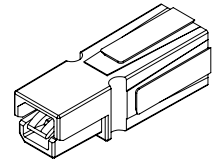

### PP15-45 Tin Plated Power Contacts

Offer cost effective performance up to 1,500 mating cycles. See specifications and temperature charts for amperage ratings by wire size.

| Barrel           | AWG          | mm <sup>2</sup> | Mating Force | Loose Piece Part Numbers | Reeled Part Numbers | Dimensions - A - |      |
|------------------|--------------|-----------------|--------------|--------------------------|---------------------|------------------|------|
|                  |              |                 |              |                          |                     | inches           | mm   |
| Minimum Quantity |              |                 |              | 200                      | 5,000               |                  |      |
| Open             | 14 to 10 K*  | 2.1 to 5.3      | High         | 269G3-LPBK               | 269G3               | 0.21             | 5.33 |
| Open             | 14 to 10 K*  | 2.1 to 5.3      | Low          | 261G2-LPBK               | 261G2               | 0.20             | 5.08 |
| Open             | 14 to 10 SF* | 2.1 to 6.0      | High         | 201G1H-LPBK              | 201G1H              | 0.24             | 6.10 |
| Open             | 14 to 10 SF* | 2.1 to 6.0      | Low          | 200G1L-LPBK              | 200G1L              | 0.24             | 6.10 |
| Open             | 16 to 12     | 1.3 to 3.3      | High         | 269G1-LPBK               | 269G1               | 0.18             | 4.57 |
| Open             | 16 to 12     | 1.3 to 3.3      | Low          | 261G1-LPBK               | 261G1               | 0.18             | 4.57 |
| Open             | 20 to 16     | 0.52 to 1.3     | High         | 269G2-LPBK               | 269G2               | 0.16             | 4.06 |
| Open             | 20 to 16     | 0.52 to 1.3     | Low          | 262G1-LPBK               | 262G1               | 0.16             | 4.06 |
| Open             | 20 to 16 SF* | 0.52 to 1.5     | Low          | 200G2L-LPBK              | 200G2L              | 0.20             | 5.08 |

Open Barrel Contact

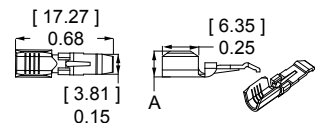

K\* - For #10 AWG class K stranded wire or smaller. For larger wires use superflex contacts.  
SF\*- Indicates wires with high stranding such as Super Flex.

### PP15-45 Silver Plated Power Contacts

Maximize performance by offering up to 10,000 mating cycles and are recommended for circuit interrupt or hot plug applications. See specifications and temperature charts for amperage ratings by wire size. Only closed barrel contacts are suitable for soldering.

| Barrel           | AWG          | mm <sup>2</sup> | Mating Force | Loose Piece |             | Reeled Part Number | Dimensions |      |       |      |  |  |  |
|------------------|--------------|-----------------|--------------|-------------|-------------|--------------------|------------|------|-------|------|--|--|--|
|                  |              |                 |              | Part Number | Part Number |                    | - A -      |      | - B - |      |  |  |  |
| Minimum Quantity |              |                 |              | 5,000       | 200         | 5,000              |            |      |       |      |  |  |  |
| Open             | 14 to 10 K*  | 2.1 to 5.3      | Low          | -           | 261G3-LPBK  | 261G3              | 0.20       | 5.08 | -     | -    |  |  |  |
| Open             | 14 to 10 SF* | 2.1 to 6.0      | High         | -           | -           | 201G3H             | 0.24       | 6.10 | -     | -    |  |  |  |
| Open             | 14 to 10 SF* | 2.1 to 6.0      | Low          | -           | 200G3L-LPBK | 200G3L             | 0.24       | 6.10 | -     | -    |  |  |  |
| Open             | 16 to 12     | 1.3 to 3.3      | Low          | -           | 261G4-LPBK  | 261G4              | 0.18       | 4.57 | -     | -    |  |  |  |
| Open             | 20 to 16     | 0.52 to 1.3     | Low          | -           | 262G2-LPBK  | 262G2              | 0.16       | 4.06 | -     | -    |  |  |  |
| Open             | 20 to 16 SF* | 0.52 to 1.5     | Low          | -           | -           | 200G4L             | 0.20       | 5.08 | -     | -    |  |  |  |
| Closed           | 16 to 12     | 1.3 to 3.3      | Low          | 1331-BK     | 1331        | -                  | 0.15       | 3.81 | 0.10  | 2.54 |  |  |  |
| Closed           | 20 to 16     | 0.52 to 1.3     | Low          | 1332-BK     | 1332        | -                  | 0.12       | 3.05 | 0.07  | 1.78 |  |  |  |

K\* - For #10 AWG class K stranded wire or smaller. For larger wires use superflex contacts.  
SF\* - Indicates wires with high stranding such as Super Flex.

Open Barrel Contact

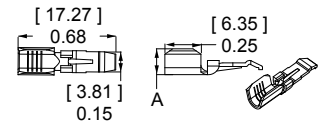

Closed Barrel Contact

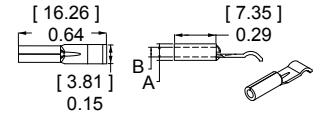

### 45A Premate Ground Wire Contacts

Tin or silver plated contacts are rated for ground or power. Hand tools are available for loose piece contacts. Reeled contacts can be used with high volume press and applicator tooling. Tin contacts are rated for up to 1,500 mating cycles. Silver contacts are rated up to 10,000 mating cycles.

| Type             | AWG      | mm <sup>2</sup> | Mating Force | Loose Piece Part Numbers | Reeled Part Numbers |
|------------------|----------|-----------------|--------------|--------------------------|---------------------|
| Minimum Quantity |          |                 |              | 200                      | 5,000               |
| Open, Tin        | 14 to 10 | 2.1 to 6.0      | Low          | 1830G1-LPBK              | 1830G1              |
| Open, Silver     | 14 to 10 | 2.1 to 6.0      | Low          | 1830G2-LPBK              | 1830G2              |

Open Barrel Premate Contact

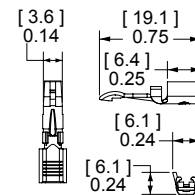

### 25A Right Angle PCB Contacts Tin Plated

Suitable for right angle applications up to 25A per pole. Tin plating enhances solderability. Cannot be mixed with 45A PCB contacts. For mating with wire contacts only.

| Row              | Mating Force | Loose Piece  |              | Dimensions |       |       |       |
|------------------|--------------|--------------|--------------|------------|-------|-------|-------|
|                  |              | Part Numbers | Part Numbers | - A -      |       | - B - |       |
| Minimum Quantity |              | 1,000        | 100          |            |       |       |       |
| Top              | Low          | 1377G1-BK    | 1377G1       | 0.59       | 14.80 | 1.52  | 38.60 |
|                  | High         | 1317G1-BK    | 1317G1       |            |       |       |       |
| Bottom           | Low          | 1377G2-BK    | 1377G2       | 0.29       | 7.20  | 1.36  | 34.50 |
|                  | High         | 1317G2-BK    | 1317G2       |            |       |       |       |
| Top              | Low          | 1377G11-BK   | 1377G11      | 0.59       | 14.80 | 1.21  | 30.70 |
|                  | High         | 1317G11-BK   | 1317G11      |            |       |       |       |
| Bottom           | Low          | 1377G12-BK   | 1377G12      | 0.29       | 7.20  | 1.01  | 25.70 |
|                  | High         | 1317G12-BK   | 1317G12      |            |       |       |       |

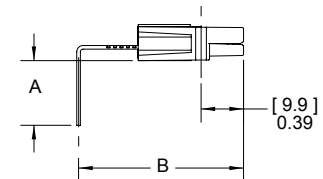
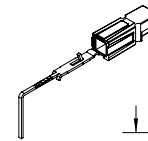

Use mounting staples with right angle contacts (see accessories).  
See website for PCB layout drawing.

### 25A Vertical PCB Contacts Tin Plated

For mating with wire contacts only. Suitable for vertical applications up to 25A per pole, tin plating enhances solderability.

| Mating Force     | Loose Piece  |              | Dimensions - A - |       |
|------------------|--------------|--------------|------------------|-------|
|                  | Part Numbers | Part Numbers | inches           | mm    |
| Minimum Quantity | 1,000        | 100          |                  |       |
| Low              | 1377G3-BK    | 1377G3       | 2.22             | 56.40 |
| High             | 1317G3-BK    | 1317G3       | 2.22             | 56.40 |
| Low              | 1377G4-BK    | 1377G4       | 1.76             | 44.70 |
| High             | 1317G4-BK    | 1317G4       | 1.76             | 44.70 |
| Low              | 1377G13-BK   | 1377G13      | 1.17             | 29.70 |
| High             | 1317G13-BK   | 1317G13      | 1.17             | 29.70 |

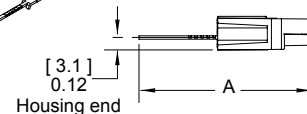
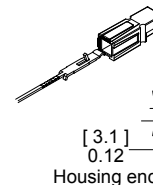

### 45A Right Angle and Vertical PCB Contacts Tin Plated

Suitable for right angle or vertical applications up to 45A per pole. Tin plating enhances solderability. Right angle contacts cannot be mixed with 25A PCB contacts. For mating with wire contacts only.

| Description            | Loose Piece  |              |
|------------------------|--------------|--------------|
|                        | Part Numbers | Part Numbers |
| Minimum Quantity       | 1,000        | 100          |
| Vertical               | 3-5911P1     | 1335G1       |
| Right Angle Bottom Row | 3-5912P1     | 1336G1       |
| Right Angle Top Row    | 3-5913P1     | 1337G1       |

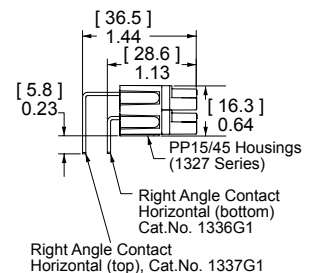
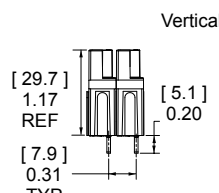

Use mounting staples with right angle contacts (see accessories).

### 45A Premate Ground PCB Contacts

Right angle contacts are suitable for power or ground. Use to mate with 45A ground wire contacts. Tin plated contacts are rated up to 1,500 mating cycles. Can be used with other 45A PCB connectors in the bottom row.

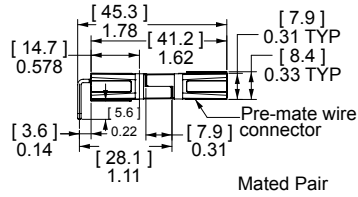

|                  | Mating Force | Loose Piece  |        |
|------------------|--------------|--------------|--------|
|                  |              | Part Numbers |        |
| Minimum Quantity |              | 1000         | 100    |
| PCB, Bottom Row  | Low          | 3-5952P1     | 1836G1 |

## | PP15-45 ULTRASONICALLY BONDED ASSEMBLIES |

Assemblies feature housings that are ultrasonically welded to create a one piece connector unit using an APP® special process. After welding, retaining pins are no longer required to secure the stacked housings to each other. This allows Powerpole® 15-45 connectors to be used as a durable one piece connector header. Contact customer service for configurations not shown below.

### Single Row 1x2 Assemblies

| Circuit Description                 | Housings Only  | Housings with 45A Vertical PCB Contacts | Housings with 45A Right Angle PCB Contacts | Color & Type Position Matrix |           |
|-------------------------------------|----------------|---|--|------------------------------|-----------|
| Minimum Quantity                    | 500            | 500                                     | 500  | 1                            | 2         |
| DC 2 Wire Standard Housings         | ASMPP30-1X2-RK | ASMPV45-1X2-RK                          | ASMPR45-1X2-RK                             | RED / STD                    | BLK / STD |
| DC 2 Wire Reverse Standard Housings | ASMPP30-1X2-KR | ASMPV45-1X2-KR                          | ASMPR45-1X2-KR                             | BLK / STD                    | RED / STD |
| DC 2 Wire Finger Proof              | ASMFP30-1X2-RK | ASMPV45-1X2-RK                          | ASMPR45-1X2-RK                             | RED / FP                     | BLK / FP  |
| DC 2 Wire Finger Proof Reverse      | ASMFP30-1X2-KR | ASMPV45-1X2-KR                          | ASMPR45-1X2-KR                             | BLK / FP                     | RED / FP  |

### Single Row 1x3 Assemblies

| Circuit Description                | Housings Only   | Housings with 45A Vertical PCB Contacts | Housings with 45A Right Angle PCB Contacts | Color & Type Position Matrix |           |          |
|------------------------------------|-----------------|---|--|------------------------------|-----------|----------|
| Minimum Quantity                   | 500             | 500                                     | 500  | 1                            | 2         | 3        |
| DC 2 Wire Finger Proof with Ground | ASMFP30-1X3-KER | N/A                                     | ASMPR45-1X3-KER                            | BLK / FP                     | GRN / GND | RED / FP |
| AC Single Phase Finger Proof       | ASMFP30-1X3-KEW | ASMPV45-1X3-KEW                         | ASMPR45-1X3-KEW                            | BLK / FP                     | GRN / GND | WHT / FP |

### Two Row 2x1 Assemblies

| Circuit Description         | Housings Only  | Housings with 45A Vertical PCB Contacts | Housings with 45A Right Angle PCB Contacts | Color & Type Position Matrix |          |
|-----------------------------|----------------|---|--|------------------------------|----------|
| Minimum Quantity            | 500            | 500                                     | 500  | 1                            | 2        |
| DC 2 Wire Finger Proof      | ASMFP30-2X1-KR | ASMPV45-2X1-KR                          | ASMPR45-2X1-KR                             | BLK / FP                     | RED / FP |
| DC 2 Wire Finger Proof Mate | ASMFP30-2X1-RK | ASMPV45-2X1-RK                          | ASMPR45-2X1-RK                             | RED / FP                     | BLK / FP |

### Two Row 2x2 Assemblies

| Circuit Description                  | Housings Only    | Housings with 45A Vertical PCB Contacts | Housings with 45A Right Angle PCB Contacts | Color & Type Position Matrix |           |          |           |
|--------------------------------------|------------------|---|--|------------------------------|-----------|----------|-----------|
| Minimum Quantity                     | 500              | 500                                     | 500  | 1                            | 2         | 3        | 4         |
| AC 3 Phase, 3 Wire Finger Proof      | ASMFP30-2X2-KRWE | N/A                                     | N/A  | BLK / FP                     | RED / FP  | WHT / FP | GRN / GND |
| AC 3 Phase, 3 Wire Finger Proof Mate | ASMFP30-2X2-WEKR | N/A                                     | ASMPR45-2X2-WEKR                           | WHT / FP                     | GRN / GND | BLK / FP | RED / FP  |



Single Row 1x2 Assembly



Single Row 1x3 Assembly



Two Row 2x1 Assembly

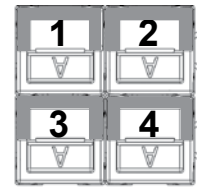

Two Row 2x2 Assembly

### Type

STD = Standard Housing  
FP = Finger Proof Housing  
GND = Ground Housing

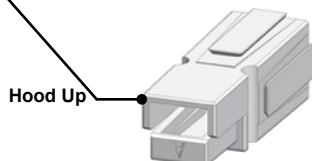

# Powerpole® Pak Connectors - PP15 to PP45

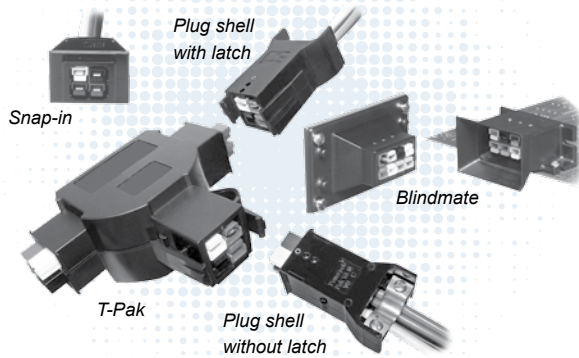

Powerpole® Pak connector shells enclose stacked groupings of PP15-45 sized housings in a durable black shell for a finished connector appearance and additional features. Inline, panel mount, and blindmate configurations are available. Plug shells offer the option of integral latches and strain relief to help secure your connection.

- **Package Groupings of PP15-45 Connectors**  
Provides a finished appearance while protecting the individual connectors with an outer shell
- **Inline, Panel Mount, “T” or Blindmate Configurations**  
Allows one connection system to meet multiple needs
- **Optional Latching and Strain Relief**  
Secures your connection and wires

For environmentally sealed connector shells to hold Powerpole® 15-180 connectors, see APP®’s SPEC Pak® product series on our website, [www.andersonpower.com](http://www.andersonpower.com)



## Powerpole® Pak ORDERING INFORMATION

Powerpole® housings and contacts are sold separately. See page 20 for ordering information.

### Plug Shell without Latch

Can mate inline with other plug shells with or without latches, or mate to a panel mount receptacle. For use with Powerpole® wire connectors only. Cable Clamp and Hardware Pak or Retaining Pins must be ordered separately.

| Description          | Part Numbers |           |        | Dimensions<br>- A - |       |
|----------------------|--------------|-----------|--------|---------------------|-------|
|                      | 1,000        | 500       | 25     | inches              | mm    |
| Minimum Quantity ... | 1,000        | 500       | 25     |                     |       |
| Black, 2-4 Poles     | 1461G1-BK    | -         | 1461G1 | 1.24                | 31.50 |
| Black, 5-6 Poles     | -            | 1461G2-BK | 1461G2 | 1.56                | 39.62 |
| Black, 7-8 Poles     | -            | 1461G3-BK | 1461G3 | 1.87                | 47.50 |

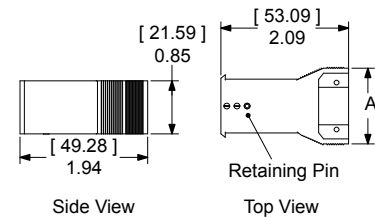

NOTE: Retaining pins are used to secure and position Powerpoles® in one of three positions in plug shells.

Max wire O.D. for 2-4 pole plug shells is 0.60 inches [15.2mm²].  
For all other plug shells is 0.63 inches [16.0 mm²].

### Plug Shell with Latch

Can mate inline with other plug shells without latches, or mate to a panel mount receptacle. For use with Powerpole® wire connectors only. Cable Clamp and Hardware Pak or Retaining Pins must be ordered separately.

| Description          | Part Numbers |           |        | Dimensions |       |        |       |        |       |
|----------------------|--------------|-----------|--------|------------|-------|--------|-------|--------|-------|
|                      | 1,000        | 500       | 25     | - B -      |       | - C -  |       | - D -  |       |
|                      |              |           |        | inches     | mm    | inches | mm    | inches | mm    |
| Minimum Quantity ... | 1,000        | 500       | 25     |            |       |        |       |        |       |
| Black, 2-4 Poles     | 1460G1-BK    | -         | 1460G1 | 1.94       | 49.28 | 2.25   | 57.15 | 1.24   | 31.50 |
| Black, 5-6 Poles     | -            | 1460G2-BK | 1460G2 | 1.94       | 49.28 | 2.25   | 57.15 | 1.56   | 39.62 |
| Black, 7-8 Poles     | -            | 1460G3-BK | 1460G3 | 1.94       | 49.28 | 2.25   | 57.15 | 1.87   | 47.50 |
| Black, 9-10 Poles    | -            | 1460G4-BK | 1460G4 | 2.51       | 63.75 | 2.82   | 71.63 | 1.84   | 46.74 |

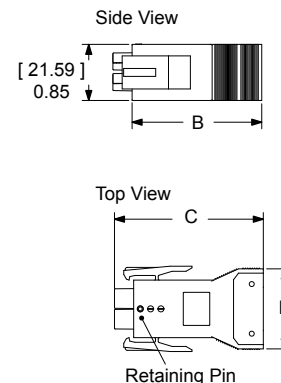

**NEW Plug Shell with Latch & Non-Conductive Strain Relief**

New 2X3 Powerpole Pak offers an improved ergonomic shell for easier latch operation as well as a plastic, non-conductive strain relief. The new strain relief can accommodate up to a 6 conductor #10 AWG cable. Can mate to a panel mount receptacle. For use with Powerpole® wire connectors only. Cable Clamp and Hardware Pak or Retaining Pins must be ordered separately. To be used with 115G23 cable clamp only.

| Description      | ----- Part Numbers ----- |         |     |
|------------------|--------------------------|---------|-----|
| Minimum Quantity | 1,000                    | 25      | ... |
| Black, 5-6 Poles | 1460G23-BK               | 1460G23 |     |

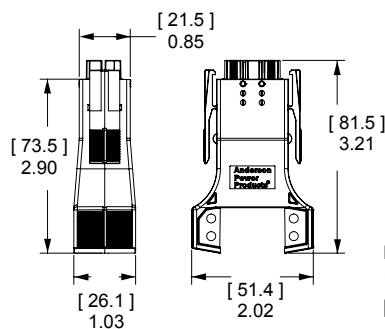

NOTE: Max wire O.D. for 1460G23 is 0.80 inches [20.3 mm<sup>2</sup>].

**Snap-in Receptacle Shell**

Mate to plug shells with or without latches, or mate to another panel mount receptacle to create a bulkhead to bulkhead connection. For use with Powerpole® wire or PCB connectors. Order the number of retaining pins for each receptacle as shown below separately.

| Description       | ----- Part Numbers ----- |           |        | Number of Retaining Pins to Order | Dimensions - E - |        | Knock Out Size - Width - |        |
|-------------------|--------------------------|-----------|--------|-----------------------------------|------------------|--------|--------------------------|--------|
|                   | Minimum Quantity         | 1,000     | 500    |                                   | 25               | inches | mm                       | inches |
| Black, 2-4 Poles  | 1470G1-BK                | -         | 1470G1 | 1                                 | 1.50             | 38.10  | 1.25                     | 31.75  |
| Black, 5-6 Poles  | -                        | 1470G2-BK | 1470G2 | 2                                 | 1.88             | 47.75  | 1.62                     | 41.15  |
| Black, 7-8 Poles  | -                        | 1470G3-BK | 1470G3 | 3                                 | 2.13             | 54.10  | 1.88                     | 47.75  |
| Black, 9-10 Poles | -                        | 1470G4-BK | 1470G4 | 4                                 | 2.44             | 61.98  | 2.19                     | 55.63  |

\* Height = [25.4 mm] 1.0 in.

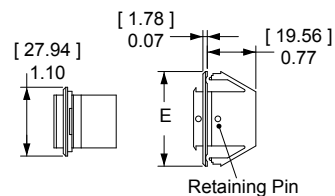

NOTE: Retaining pins are used to secure and position Powerpoles® in one of two positions in receptacle shells.

**Cable Clamp & Hardware Pak**

Includes cable clamp, 2 screws, and required amount of retaining pins for each configuration.

| Description      | Screw Head Type | Cable Type | ----- Part Numbers ----- |          |        |
|------------------|-----------------|------------|--------------------------|----------|--------|
| Minimum Quantity |                 |            | 1,000                    | 500      | 25 ... |
| 2-4 Poles        | Straight Slot   | Bundled    | 115G1-BK                 | -        | 115G1  |
| 5-6 Poles        | Straight Slot   | Bundled    | 115G2-BK                 | -        | 115G2  |
| 7-8 Poles        | Straight Slot   | Bundled    | 115G3-BK                 | -        | 115G3  |
| 9-10 Poles       | Straight Slot   | Bundled    | -                        | 115G4-BK | 115G4  |
| 2-4 Poles        | Philips         | Bundled    | 115G7-BK                 | -        | 115G7  |
| 5-6 Poles        | Philips         | Bundled    | 115G8-BK                 | -        | 115G8  |

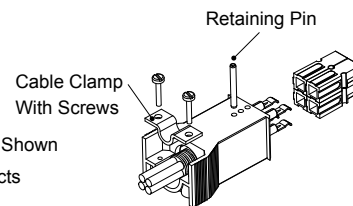

Plug Shell Without Latch Shown  
Shell, housing and contacts are sold separately.

**NEW Cable Clamp & Hardware Pak**

Includes 2 cable clamp halves, 2 screws and 2 retaining pins. To be used with 1460G23 Plug Shell only.

| Description      | Screw Head Type | Cable Type | ----- Part Numbers ----- |        |
|------------------|-----------------|------------|--------------------------|--------|
| Minimum Quantity |                 |            | 1,000                    | 25     |
| 5-6 Poles        | Philips         | Bundled    | 115G23-BK                | 115G23 |

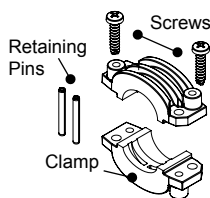

**Flexible Conduit Clamp & Hardware Pak**

Includes cable clamp, 2 screws, and need amount of retaining pins for each configuration.

| Description      | - Part Number - |
|------------------|-----------------|
| Minimum Quantity | ..... 100 ..... |
| 2-4 Poles        | 110G10          |

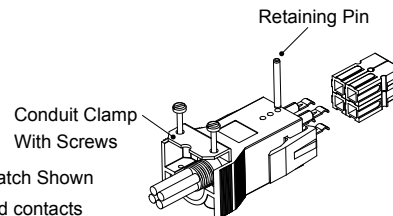

Plug Shell With Latch Shown  
Shell, housing and contacts are sold separately.

**Retaining Pin for Snap-in Receptacle**

Order the number of retaining pins for each receptacle shown in the Snap-in Receptacle Shell ordering information. Pins are also required for the plug side when the Cable Clamp & Hardware Pak is not ordered.

| Description      | ----- Part Number ----- |         |
|------------------|-------------------------|---------|
| Minimum Quantity | ..... 1,000             | 100 ... |
| Retaining Pin    | 110G9-BK                | 110G9   |

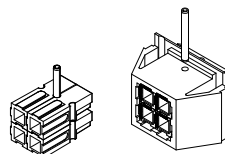

Shell and housing are sold separately.



### Blindmate Pak Connector

Ideal for panel to panel, bulkhead to bulkhead, or rack mount applications that require the power connector to compensate for up to 0.45 in. [11.43 mm] of misalignment in either axis. Eight positions can be filled with Powerpole® 10-45 connectors. The receptacle side can be used with wire or PCB contacts. Hardware bag includes retaining pins.

| Description                                     | ----- Part Numbers ----- |            |
|---|--------------------------|------------|
| Minimum Quantity .....                          | 50                       | 25 .....   |
| 2x4 Blindmate Plug Shell, Hardware & Pins       | -                        | BMPP10-45P |
| 2x4 Blindmate Receptacle Shell, Hardware & Pins | -                        | BMPP10-45R |
| 2x4 Blindmate Plug Shell                        | BMHSG-P                  | -          |
| 2x4 Blindmate Receptacle Shell                  | BMHSG-R                  | -          |
| Hardware Bag Plug Side                          | -                        | 110G50     |
| Hardware Bag Receptacle Side                    | -                        | 110G51     |

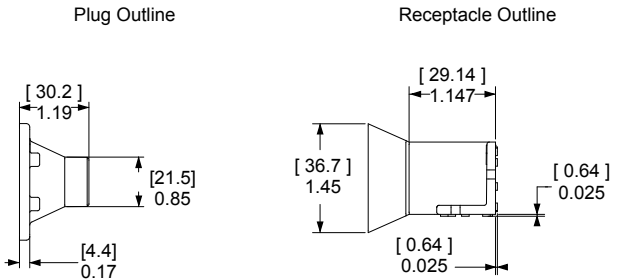
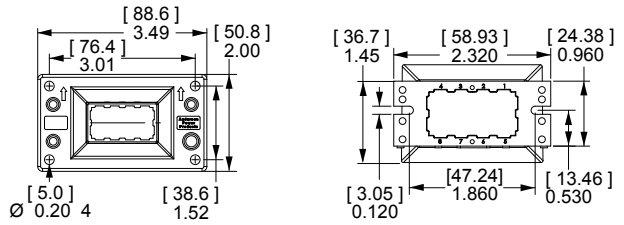

See APP's innovative MARC Connector that offers straight-on or rotational blindmate capability. MARC holds 6 PP15/45 power contacts and 2 PP15/45 premate ground contacts in a high temperature housing. Visit our website, [www.andersonpower.com](http://www.andersonpower.com) to learn more.



### "T" Pak 2 Way Splitter

The Powerpole® "T" Pak connector is a 2 way electrical splitter that splits electrical current from one incoming circuit into two outgoing circuits. The standard configuration is pre-wired for AC 3 phase, 3 wire plus ground configurations. The "T" Pak can also be used for AC single phase plus ground or DC 2 wire plus ground applications by not using either the red or white power positions. "T" Pak is pre-wired from the factory allowing plug and play field installation of modular office and industrial equipment. UL recognition up to 20 amps and 600 volts is achieved when mating Powerpole® Pak plugs are used with #12 AWG wire.

For OEM manufacturing scale applications, the "T" Pak can be loaded with custom configurations of any of APP's finger proof, standard, or ground housings and contacts in the PP15-45 series. Contact APP® sales or customer service for additional information.

| Description                         | - Part Numbers - |
|-------------------------------------|------------------|
| Minimum Quantity .....              | 80 .....         |
| Assembled "T" Pak                   | 20-01            |
| Mating Plug Shell with Latch 2x2    | 26-01            |
| Mating Plug Shell without Latch 2x2 | 27-01            |

Standard configuration for each side of the T includes (1) each Red, Black, and White Standard PP 15-45 Housings & 261G2-LPBK contacts with (1) 45A Green Premate Ground Housing and 1830G1-LPBK contact.

Mating plug shells include (1) each Red, Black, and White Standard PP 15-45 Housings & (3) 261G2-LPBK contacts with (1) 45A Green Premate Ground Housing and 1830G1-LPBK contact. Cable clamp & hardware pak also included.

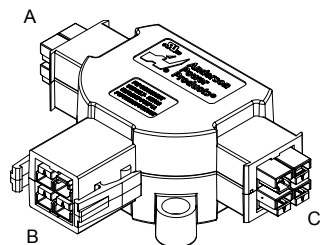
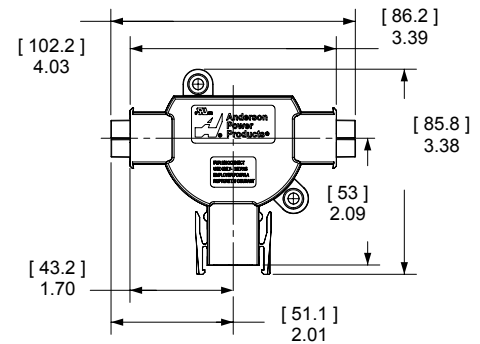

# PP15-45 & POWERPOLE® PAK SPECIFICATIONS |

SECTION 2  
Powerpole® PP15 to 45

| Electrical  |                |                |
|---|----------------|----------------|
| <b>Current Rating Amperes<sup>1</sup></b>                     | <b>UL 1977</b> | <b>CSA/TUV</b> |
| Singlepole Wire to Wire (10 AWG)                              | 55             | 40             |
| Singlepole Ground Wire to Wire or PCB (10 AWG)                | 45             | 35             |
| 3x3 Block Wire to Wire (10 AWG)                               | 40             | 27             |
| Singlepole 25A PCB to Wire (12 AWG)                           | 25             | -              |
| 2x3 Block 25A PCB to Wire (12 AWG)                            | 25             | 22 *           |
| Singlepole 45A PCB to Wire (10 AWG)                           | 45             | 40 *           |
| 2x3 Block 45A PCB to Wire (10 AWG)                            | 45             | 25 *           |
| <b>Voltage Rating AC/DC</b>                                   |                |                |
| UL 1977   | 600            |                |
| <b>PCB Connector Recommended Voltage<sup>3</sup></b>          |                |                |
| <b>per IEC 60950-1 Table 2L Pollution Degree<sup>2</sup></b>  |                |                |
| 25A Contacts Adjacent Poles                                   | 495            |                |
| 25A Contacts Separated by Spacer                              | 1,000          |                |
| 45A Contacts Adjacent Poles                                   | 160            |                |
| 45A Contacts Separated by Spacer                              | 970            |                |
| <b>Dielectric Withstanding Voltage</b>                        |                |                |
| Volts AC  | 2,200          |                |
| <b>Avg. Mated Contact Resistance Milliohms<sup>1</sup></b>    |                |                |
| 15A Wire Contact with 5/8" of #16 AWG                         | 0.875          |                |
| 30A Wire Contact with 5/8" of #12 AWG                         | 0.600          |                |
| 45A Wire Contact with 5/8" of #10 AWG                         | 0.525          |                |
| 45A PCB Contact to Contact                                    | 0.500          |                |
| 25A PCB Contact to Contact                                    | 0.600          |                |
| <b>UL Hot Plug Current Rating Amperes</b>                     |                |                |
| 250 cycles at 72V DC  | 45A            |                |
| 250 cycles at 120V DC   | 30A            |                |
| <b>UL Ground Short Time Current Test - 45A Premate Ground</b> |                |                |
| 750 Amps, #10 AWG Wire  | 4 Seconds      |                |
| 470 Amps, #12 AWG Wire  | 4 Seconds      |                |

| Materials                          |                           |
|------------------------------------|---------------------------|
| <b>Housing</b>                     |                           |
| Plastic Resin                      | Polycarbonate             |
| Contact Retention Spring           | Stainless Steel           |
| <b>Housing Flammability Rating</b> |                           |
| UL94                               | V-0                       |
| <b>Contact</b>                     |                           |
| Base                               | Copper Alloy              |
| Plating                            | Tin or Silver             |
| <b>Contact Termination Methods</b> |                           |
| Crimp <sup>3</sup>                 | Wire Contacts             |
| Hand Solder                        | 1331, 1332 & PCB Contacts |
| Solder Dip                         | PCB Contacts              |
| Wave Solder                        | PCB Contacts              |

| Mechanical                                    |                       |                       |
|---|-----------------------|-----------------------|
| <b>Wire Size Range</b>                        | <b>AWG</b>            | <b>mm<sup>2</sup></b> |
|   | 20 to 10              | 0.75 to 6.0           |
| <b>Max. Wire Insulation Diameter</b>          | <b>in.</b>            | <b>mm</b>             |
|   | 0.175                 | 4.450                 |
| <b>Operating Temperature<sup>2</sup></b>      | <b>°F</b>             | <b>°C</b>             |
| Powerpole® Housings & Powerpole® Pak Shells   | -4° to 221°           | -20° to 105°          |
| <b>Mating Cycles No Load by Plating</b>       | <b>Silver (Ag)</b>    | <b>Tin (Sn)</b>       |
| PCB to Wire                                   | -                     | 1,500                 |
| Wire to Wire                                  | 10,000                | 1,500                 |
| <b>Avg. Mating / Unmating Force</b>           | <b>Lbf.</b>           | <b>N</b>              |
| Low Force Wire, High Force PCB, & Ground      | 3                     | 13                    |
| High Force Wire                               | 5                     | 22                    |
| Low Force PCB                                 | 2                     | 9                     |
| <b>Min. Contact / Spring Retention Force</b>  | <b>Lbf.</b>           | <b>N</b>              |
|   | 20                    | 90                    |
| <b>Powerpole® Pak Latch Avg. Defeat Force</b> | <b>Lbf.</b>           | <b>N</b>              |
|   | 150                   | 667                   |
| <b>PCB Specifications</b>                     |                       |                       |
| Mounting Style                                | Plated Through Hole   |                       |
| PCB Thickness- in. [mm]                       | 0.090 - 0.150         | (2.3-3.8)             |
| 25A PCB Recommended Traces                    | #12 AWG Cross Section |                       |
| 45A PCB Recommended Traces                    | #10 AWG Cross Section |                       |
| <b>Min. Creepage / Clearance Distance PCB</b> | <b>in.</b>            | <b>mm</b>             |
| 25A Creepage & Clearance Adjacent Poles       | 0.201                 | 5.1                   |
| 45A Creepage & Clearance Adjacent Poles       | 0.067                 | 1.7                   |
| <b>Mechanical Shock <sup>4</sup></b>          |                       |                       |
| MIL-STD-202                                   | 213 Condition A       | 50g's                 |
| <b>Vibration High Frequency <sup>4</sup></b>  |                       |                       |
| MIL-STD-202                                   | 204 Condition A       | 10g's                 |

| Protection   |      |
|--|------|
| <b>Touch Safety with Finger Proof Housings &amp; Wire Contacts or PCB Mating Interface</b> |      |
| UL1977 Sec. 10.2   | Pass |
| IEC 60950  | Pass |
| IEC 60529  | IP20 |
| <b>Touch Safety Standard Housings</b>  |      |
| IEC 60529  | IP10 |

\* No TUV Recognition  
<sup>1</sup> Based on: 105°C rated or better cable of the largest size, Properly calibrated APP® recommended tooling, and a 25°C ambient temperature. UL rating not to exceed the maximum operating temperature. CSA rating below a 30°C temperature rise.  
<sup>2</sup> Limited by the thermal properties of the connector plastic housing.  
<sup>3</sup> Use APP® recommended tooling only. Alternate tools may adversely affect the performance of our connectors along with UL and CSA recognition.  
<sup>4</sup> Tested with contact part number 261G2.

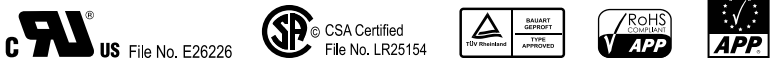

# | PP15-45 TEMPERATURE CHARTS |

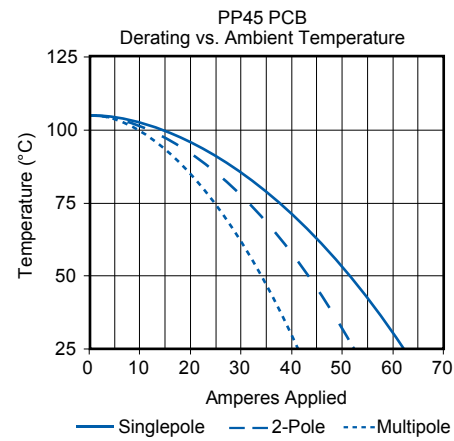
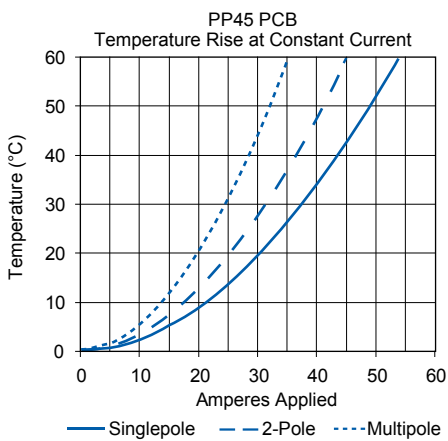
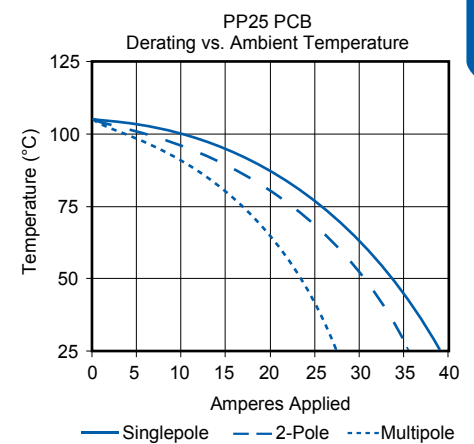
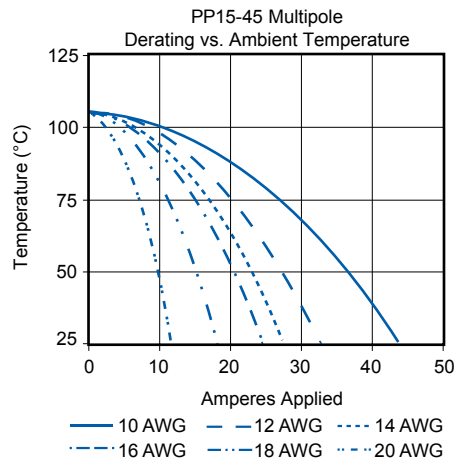
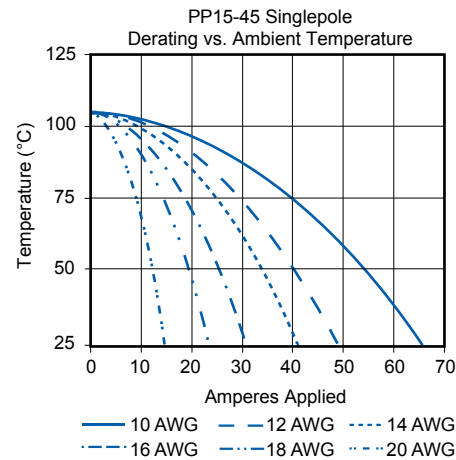
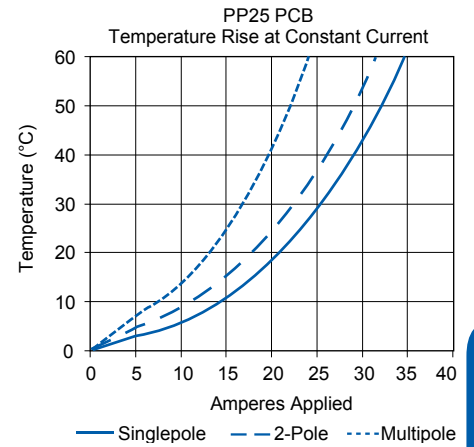
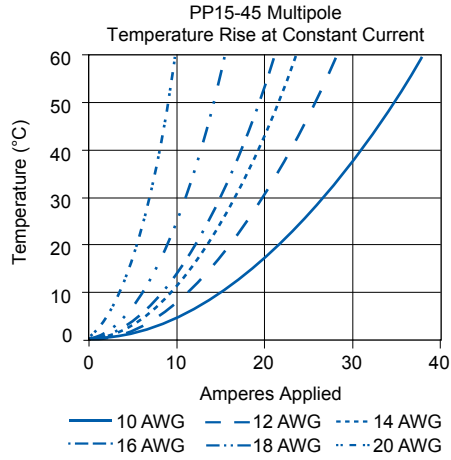
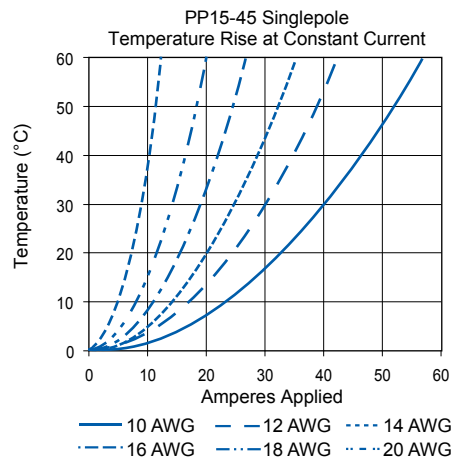

NOTE: Temperature rise charts are based on a 25°C ambient temperature. PP25 PCB charts based on 0.002 in<sup>2</sup> foil on board side, mated to #12 AWG conductor on wire side. PP45 PCB charts based on #10 AWG equivalent copper foil on board side, mated to #10 AWG conductor on wire side.



# | Powerpole® 15-45 Accessories |

## Mounting Wing

Secure dovetailed Powerpole® 15-45 series housings by passing fasteners through the wings in either a horizontal or vertical orientation. Useful for sheet metal panels, printed circuit boards, and many other mounting surfaces. Fasteners not included.

| Description          | ----- Part Numbers ----- |        |
|----------------------|--------------------------|--------|
| Minimum Quantity ... | 2,500                    | 100    |
| Red                  | 1399G9-BK                | 1399G9 |
| Blue                 | 1399G8-BK                | 1399G8 |

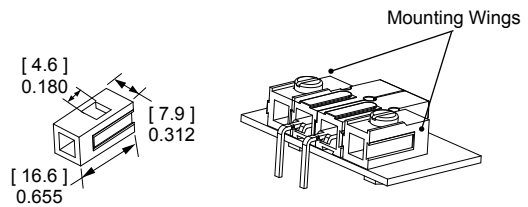

## Spacer

Used to separate housings under high power to minimize derating. They are recommended for squaring off a block of Powerpole® 15-45 housings for use in connector shells and mounting clamps. Use a combination of long and short spacers opposite each other in a mated block to add keying features or use two short spacers to avoid interference. Spacers with holes can also be used to fasten the blocked housings to a surface with a fastener.

| Description            | ----- Part Numbers ----- |         |
|------------------------|--------------------------|---------|
| Minimum Quantity ..... | 2,500                    | 100     |
| Red, Short w/ Hole     | 1399G1-BK                | 1399G1  |
| Red, Long              | 1399G2-BK                | 1399G2  |
| Red, Short             | 1399G6-BK                | 1399G6  |
| Black, Long            | 1399G10-BK               | 1399G10 |
| Blue, Short            | 1399G13-BK               | 1399G13 |
| White, Short w/ Hole   | 1399G14-BK               | 1399G14 |
| White, Long            | 1399G17-BK               | 1399G17 |

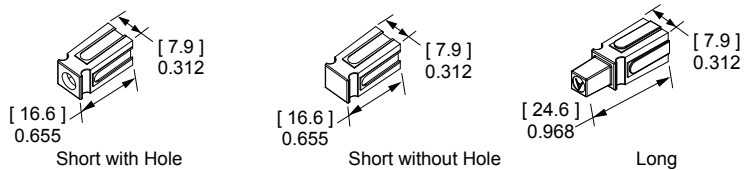

## Retaining Pins

Keep stacked Powerpole® 15-45 series housings from separating. Retaining pins are inserted in the circular opening between two housings stacked side by side.

| Description          | ----- Part Numbers ----- |        | Dimensions    |              |       |        |
|----------------------|--------------------------|--------|---------------|--------------|-------|--------|
|                      |                          |        | - A -         |              | - B - |        |
|                      |                          |        |               |              |       |        |
| Minimum Quantity ... | 1,000                    | 100    |               |              |       |        |
| 1 Block High         | H1507P38                 | 110G16 | 0.094         | 2.390        | 0.250 | 6.350  |
| 2 Block High         | 111812P5                 | 110G17 | 0.099 / 0.106 | 0.251 / 2.69 | 0.440 | 11.180 |

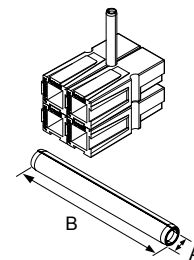

## Mounting Clamp

Mounting clamps can be used for fastening a block of Powerpole® 15-45 series housings to a panel. Connector blocks must be a complete square for the clamps to work properly. Fastening hardware not included.

| Description          | -- Part Numbers -- |
|----------------------|--------------------|
| Minimum Quantity ... | 100 sets of 2      |
| 2 or 4 Pole          | 1462G1             |
| 3 or 6 Pole          | 1462G2             |
| 4 or 8 Pole          | 1462G3             |

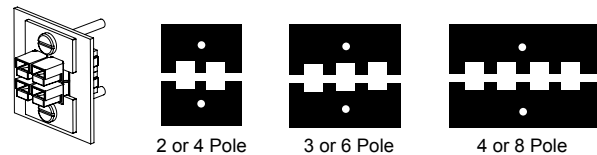

### PCB Mounting Staples

PCB staples are soldered into place to secure Powerpole® 15-45 series housings in a horizontal configuration to the board. Reduce strain on soldering joints during mating and unmating.

| Part Numbers                | H x W | Length | Dimensions |      |        |      |
|-----------------------------|-------|--------|------------|------|--------|------|
|                             |       |        | - A -      |      | - B -  |      |
|                             |       |        | inches     | mm   | inches | mm   |
| <b>Minimum Quantity 100</b> |       |        |            |      |        |      |
| 114555P1                    | 1 x 1 | Short  | 0.47       | 12.0 | 0.28   | 7.0  |
| 114555P2                    | 1 x 2 | Short  | 0.47       | 12.0 | 0.57   | 14.5 |
| 114555P3                    | 1 x 3 | Short  | 0.47       | 12.0 | 0.89   | 22.5 |
| 114555P7                    | 1 x 4 | Short  | 0.47       | 12.0 | 1.20   | 30.5 |
| 114555P12                   | 1 x 4 | Long   | 0.67       | 17.0 | 1.20   | 30.5 |
| 114555P8                    | 1 x 6 | Short  | 0.47       | 12.0 | 1.83   | 46.5 |
| 114555P10                   | 2 x 1 | Short  | 0.79       | 20.0 | 0.28   | 7.0  |
| 114555P6                    | 2 x 2 | Short  | 0.79       | 20.0 | 0.57   | 14.5 |
| 114555P9                    | 2 x 2 | Long   | 0.91       | 23.0 | 0.57   | 14.5 |
| 114555P14                   | 2 x 5 | Long   | 0.91       | 23.0 | 1.52   | 38.5 |
| 114555P4                    | 3 x 2 | Short  | 1.10       | 28.0 | 0.57   | 14.5 |

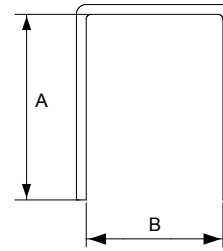

### Retention Clip

Retention clips prevent Powerpole® 15-45 blocks from unintended disconnects. They feature a tab for easy insertion and removal.

| Description                 | -- Part Number -- |
|-----------------------------|-------------------|
| <b>Minimum Quantity 100</b> |                   |
| 1 Block High                | 110G68            |

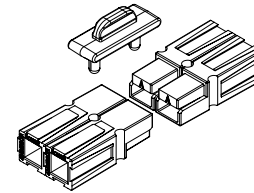

### Block Lok

Block locks secure mated Powerpole® 15-45 series housings together. For use in high vibration or shock applications where connectors are unmated infrequently.

| Description                 | - Part Numbers - |
|-----------------------------|------------------|
| <b>Minimum Quantity 100</b> |                  |
| 2 Pole, Black               | 110G21           |
| 4 Pole, Black               | 110G12           |

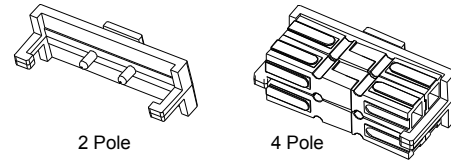

2 Pole                      4 Pole  
Shown without Powerpoles®      Shown with Powerpoles®

### Splash Boot

Splash boots protect a 2x2 block of any combination of Powerpole® 15-45 series housings and feature snip off sealed ends for flexibility in wire O.D. Designed for through panel or inline applications. Not a hermetic seal.

| Description                | - Part Numbers - |
|----------------------------|------------------|
| <b>Minimum Quantity 25</b> |                  |
| Female, Black              | 1441G1           |
| Male, Black                | 1442G1           |

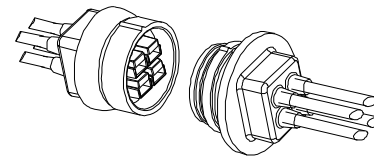

For environmentally sealed connector shells to hold Powerpole® 15-180 connectors, see APP's SPEC Pak® product series on our website, [www.andersonpower.com](http://www.andersonpower.com)



# Powerpole® - Tooling Information

| Wire Size                                       |                 | Reeled Part Numbers |                | Reeled Contact Crimp Tool |                               |                |                               |                               |
|---|-----------------|---------------------|----------------|---------------------------|-------------------------------|----------------|-------------------------------|-------------------------------|
| AWG   | mm <sup>2</sup> | Tin Plating         | Silver Plating | APP Applicator            | APP Press                     | ATS Applicator | ATS Press                     | Air Feed Kit *                |
| <b>PP15 / 45 Flat Wiping Power &amp; Ground</b> |                 |                     |                |                           |                               |                |                               |                               |
| #16 / 20  | 1.3 / 0.52      | 262G1               | 262G2          | TD0101                    | 115V= TE0101<br>230V = TE0102 | 1385519-1      | 1725900-2<br>or<br>[354500-1] | 1424266-1<br>or<br>[354578-1] |
| #16 / 20  | 1.3 / 0.52      | 269G2               | N/A            |                           |                               | 1385519-1      |                               |                               |
| #12 / 16  | 3.3 / 1.3       | 261G1               | 261G4          |                           |                               | 1385520-1      |                               |                               |
| #10 / 14  | 5.3 / 2.1       | 261G2               | 261G3          |                           |                               | 1385458-1      |                               |                               |
| #12 / 16  | 3.3 / 1.3       | 269G1               | N/A            |                           |                               | 1385520-1      |                               |                               |
| #10 / 14  | 5.3 / 2.1       | 269G3               | N/A            |                           |                               | 1385458-1      |                               |                               |
| #10 / 14  | 5.3 / 2.1       | 200G1L              | 200G3L         | TD0102                    |                               | 1385460-1      |                               |                               |
| #10 / 14  | 5.3 / 2.1       | 201G1H              | 201G3H         |                           | 1385460-1                     |                |                               |                               |
| #10 / 14  | 5.3 / 2.1       | 1830G1              | 1830G2         |                           | 1385460-1                     |                |                               |                               |

NOTE: Insertion / Extraction tool for PP15/45 contacts = 111038G2

\* All ATS applicators for APP® contacts are air feed style, (except 1385870) and require the press to have an air feed kit installed. APP applicators are mechanical feed style and do not require an air feed kit.

| Wire Size                                       |                 | Loose Piece Part Numbers |                | Loose Piece Contact Crimp Tool |                      |         |         |                  |
|---|-----------------|--------------------------|----------------|--------------------------------|----------------------|---------|---------|------------------|
| AWG   | mm <sup>2</sup> | Tin Plating              | Silver Plating | Hand Tool                      | Pneumatic Bench Tool | Die     | Locator | Number of Crimps |
| <b>PP15 / 45 Flat Wiping Power &amp; Ground</b> |                 |                          |                |                                |                      |         |         |                  |
| #16 / 20  | 1.3 / 0.52      | N/A                      | 1332           | 1309G2<br>or<br>1309G8         | 1367G1               | N/A     | N/A     | Single           |
| #12 / 16  | 3.3 / 1.3       | N/A                      | 1331           |                                |                      |         |         |                  |
| #16 / 20  | 1.3 / 0.52      | 262G1-LPBK               | 262G2-LPBK     | 1309G3<br>or<br>1309G8         | N/A                  | N/A     | N/A     | Single           |
| #16 / 20  | 1.3 / 0.52      | 269G2-LPBK               | N/A            |                                |                      |         |         |                  |
| #12 / 16  | 3.3 / 1.3       | 261G1-LPBK               | 261G4-LPBK     | 1309G6<br>or<br>1309G8         | N/A                  | N/A     | N/A     | Single           |
| #10 / 14  | 5.3 / 2.1       | 261G2-LPBK               | 261G3-LPBK     |                                |                      |         |         |                  |
| #12 / 16  | 3.3 / 1.3       | 269G1-LPBK               | N/A            | 1309G6<br>or<br>1309G8         | N/A                  | N/A     | N/A     | Single           |
| #10 / 14  | 5.3 / 2.1       | 269G3-LPBK               | N/A            |                                |                      |         |         |                  |
| #10 / 14  | 5.3 / 2.1       | 200G1L-LPBK              | 200G3L-LPBK    | 1309G6<br>or<br>1309G8         | N/A                  | N/A     | N/A     | Single           |
| #10 / 14  | 5.3 / 2.1       | 201G1H-LPBK              | 201G3H-LPBK    |                                |                      |         |         |                  |
| 310 / 14  | 5.3 / 2.1       | 1830G1-LPBK              | 1830G2-LPBK    |                                |                      |         |         |                  |
| <b>PP75</b>                                     |                 |                          |                |                                |                      |         |         |                  |
| #6  | 13.3            | N/A                      | 1307           | 1309G4                         | 1387G1               | 1388G6  | 1389G6  | Single           |
|   |                 |                          | 5900           |                                |                      |         |         |                  |
| #8  | 8.4             |                          | 5952           |                                |                      |         |         |                  |
| #10 / 12  | 5.3 / 3.3       |                          | 5953           |                                |                      |         |         |                  |
|   |                 |                          | 5915           |                                |                      | 1388G7  |         |                  |
| <b>PP120</b>                                    |                 |                          |                |                                |                      |         |         |                  |
| 1/0   | 53.5            | N/A                      | 1323G2         | 1368<br>Series                 | 1387G1               | 1388G3  | 1389G4  | Single           |
| #1  | 42.4            |                          | 1323G1         |                                |                      |         |         |                  |
| #2  | 33.6            |                          | 1319           |                                |                      |         |         |                  |
| #4  | 21.2            |                          | 1319G4         |                                |                      |         |         |                  |
| #6  | 13.3            |                          | 1319G6         |                                |                      |         |         |                  |
| <b>PP180</b>                                    |                 |                          |                |                                |                      |         |         |                  |
| 3/0   | 85              | N/A                      | 1328G2         | 1368<br>Series                 | 1387G2               | 1303G12 | 1304G32 | Double           |
| 2/0   | 53.5            |                          | 1328G1         |                                |                      |         |         |                  |
| 1/0   | 53.5            |                          | 1382           |                                |                      |         |         |                  |
| #1  | 42.4            |                          | 1347           |                                |                      |         |         |                  |
| #2  | 33.6            |                          | 1383           |                                |                      |         |         |                  |
| #4  | 21.1            |                          | 1384           |                                |                      |         |         |                  |
| #6  | 13.3            | 1348                     |                | 1387G1                         | 1388G4               | 1389G3  | Single  |                  |

- NOTE: See website for the most current information.
- NOTE: Insertion / Extraction tool for PP15/45 contacts = 111038G2

# Mouser Electronics

Authorized Distributor

Click to View Pricing, Inventory, Delivery & Lifecycle Information:

## Anderson Power Products:

[PP45PC12S](#) [PP45PC13R](#) [PP45PC13S](#) [PP45PC22R](#) [PP45PC23R](#) [1335G1](#) [1336G1](#) [1337G1](#)



Компания «ЭлектроПласт» предлагает заключение долгосрочных отношений при поставках импортных электронных компонентов на взаимовыгодных условиях!

Наши преимущества:

- Оперативные поставки широкого спектра электронных компонентов отечественного и импортного производства напрямую от производителей и с крупнейших мировых складов;
- Поставка более 17-ти миллионов наименований электронных компонентов;
- Поставка сложных, дефицитных, либо снятых с производства позиций;
- Оперативные сроки поставки под заказ (от 5 рабочих дней);
- Экспресс доставка в любую точку России;
- Техническая поддержка проекта, помощь в подборе аналогов, поставка прототипов;
- Система менеджмента качества сертифицирована по Международному стандарту ISO 9001;
- Лицензия ФСБ на осуществление работ с использованием сведений, составляющих государственную тайну;
- Поставка специализированных компонентов (Xilinx, Altera, Analog Devices, Intersil, Interpoint, Microsemi, Aeroflex, Peregrine, Syfer, Eurofarad, Texas Instrument, Miteq, Cobham, E2V, MA-COM, Hittite, Mini-Circuits, General Dynamics и др.);

Помимо этого, одним из направлений компании «ЭлектроПласт» является направление «Источники питания». Мы предлагаем Вам помощь Конструкторского отдела:

- Подбор оптимального решения, техническое обоснование при выборе компонента;
- Подбор аналогов;
- Консультации по применению компонента;
- Поставка образцов и прототипов;
- Техническая поддержка проекта;
- Защита от снятия компонента с производства.



#### Как с нами связаться

**Телефон:** 8 (812) 309 58 32 (многоканальный)

**Факс:** 8 (812) 320-02-42

**Электронная почта:** [org@eplast1.ru](mailto:org@eplast1.ru)

**Адрес:** 198099, г. Санкт-Петербург, ул. Калинина, дом 2, корпус 4, литера А.