PIC18F2X/4XQ10 Product Brief

Description

PIC18F2x/4xQ10 microcontrollers feature Analog, Core Independent, and Communication Peripherals for a wide range of general purpose and low-power applications. These 28/40/44 -pin devices are equipped with a 10-bit ADC with Computation (ADC²) automating Capacitive Voltage Divider (CVD) techniques for advanced touch sensing, averaging, filtering, oversampling and performing automatic threshold comparisons. They also offer a set of Core Independent Peripherals such as Complementary Waveform Generator (CWG), Windowed Watchdog Timer (WWDT), Cyclic Redundancy Check (CRC)/Memory Scan, Zero-Cross Detect (ZCD), Configurable Logic Cell (CLC), and Peripheral Pin Select (PPS), providing for increased design flexibility and lower system cost.

Core Features

- C Compiler Optimized RISC Architecture
- Operating Speed:
 - DC – 64 MHz clock input over the full V_{DD} range
 - 62.5 ns minimum instruction cycle
- Programmable 2-Level Interrupt Priority
- 31-Level Deep Hardware Stack
- Three 8-Bit Timers (TMR2/4/6) with Hardware Limit Timer (HLT)
- Four 16-Bit Timers (TMR0/1/3/5)
- Low-Current Power-on Reset (POR)
- Power-up Timer (PWRT)
- Brown-out Reset (BOR)
- Low-Power BOR (LPBOR) Option
- Windowed Watchdog Timer (WWDT):
 - Watchdog Reset on too long or too short interval between watchdog clear events
 - Variable prescaler selection
 - Variable window size selection
 - All sources configurable in hardware or software

Memory

- Up to 128K Bytes Program Flash Memory
- Up to 3615 Bytes Data SRAM Memory
- Up to 1024 Bytes Data EEPROM
- Programmable Code Protection

- Direct, Indirect and Relative Addressing modes

Operating Characteristics

- Operating Voltage Range:
 - 1.8V to 5.5V
- Temperature Range:
 - Industrial: -40°C to 85°C
 - Extended: -40°C to 125°C

Power-Saving Operation Modes

- Doze: CPU and Peripherals Running at Different Cycle Rates (typically CPU is lower)
- Idle: CPU Halted While Peripherals Operate
- Sleep: Lowest Power Consumption
- Peripheral Module Disable (PMD):
 - Ability to selectively disable hardware module to minimize active power consumption of unused peripherals
- Extreme Low-Power mode (XLP)
 - Sleep: 500 nA typical @ 1.8V
 - Sleep and Watchdog Timer: 900 nA typical @ 1.8V

Digital Peripherals

- Configurable Logic Cell (CLC):
 - Integrated combinational and sequential logic
- Complementary Waveform Generator (CWG):
 - Rising and falling edge dead-band control
 - Full-bridge, half-bridge, 1-channel drive
 - Multiple signal sources
- Capture/Compare/PWM (CCP) modules:
 - Two CCPs
 - 16-bit resolution for Capture/Compare modes
 - 10-bit resolution for PWM mode
- 10-Bit Pulse-Width Modulators (PWM):
 - Two 10-bit PWMs
- Serial Communications:
 - Up to Two Enhanced USART (EUSART) with Auto-Baud Detect, Auto-wake-up on Start. RS-232, RS-485, LIN compatible
 - SPI
 - I²C, SMBus and PMBus™ compatible
- Up to 35 I/O Pins and One Input Pin:
 - Individually programmable pull-ups
 - Slew rate control
 - Interrupt-on-change on all pins

- Input level selection control
- Programmable CRC with Memory Scan:
 - Reliable data/program memory monitoring for Fail-Safe operation (e.g., Class B)
 - Calculate CRC over any portion of Flash or EEPROM
 - High-speed or background operation
- Hardware Limit Timer (TMR2/4/6+HLT):
 - Hardware monitoring and Fault detection
- Peripheral Pin Select (PPS):
 - Enables pin mapping of digital I/O
- Data Signal Modulator (DSM)

Analog Peripherals

- 10-Bit Analog-to-Digital Converter with Computation (ADC²):
 - Up to 35 external channels
 - Conversion available during sleep
 - Four internal analog channels
 - Internal and external trigger options
 - Automated math functions on input signals:
 - Averaging, filter calculations, oversampling and threshold comparison
 - 8-bit hardware acquisition timer
- Hardware Capacitive Voltage Divider (CVD) Support:
 - 8-bit precharge timer
 - Adjustable sample and hold capacitor array
 - Guard ring digital output drive
- Zero-Cross Detect (ZCD):
 - Detect when AC signal on pin crosses ground
- 5-Bit Digital-to-Analog Converter (DAC):
 - Output available externally
 - Programmable 5-bit voltage (% of V_{DD} , $[V_{Ref+} - V_{Ref-}]$, FVR)
 - Internal connections to comparators and ADC
- Two Comparators (CMP):
 - Four external inputs
 - External output via PPS
- Fixed Voltage Reference (FVR) Module:
 - 1.024V, 2.048V and 4.096V output levels
 - Two buffered outputs: One for DAC/CMP and one for ADC

Clocking Structure

- High-Precision Internal Oscillator Block (HFINTOSC):
 - Selectable frequencies up to 64 MHz
 - $\pm 1\%$ at calibration
- 32 kHz Low-Power Internal Oscillator (LFINTOSC)
- External 32 kHz Crystal Oscillator (SOSC)

- External High-frequency Oscillator Block:
 - Three crystal/resonator modes
 - Digital Clock Input mode
 - 4x PLL with external sources
- Fail-Safe Clock Monitor:
 - Allows for safe shutdown if external clock stops
- Oscillator Start-up Timer (OST)

Programming/Debug Features

- In-Circuit Serial Programming™ (ICSP™) via Two Pins
- In-Circuit Debug (ICD) with Three Breakpoints via Two Pins
- Debug Integrated On-Chip

PIC18F2x/4xQ10 Family Types

Table 1. Devices included in this family

Device	Program Memory Flash (bytes)	Data SRAM (bytes)	Data EEPROM (bytes)	I/O Pins	16-bit Timers	Comparators	10-bit ADC ² with Computation (ch)	5-bit DAC	Zero-Cross Detect	CCP/10-bit PWM	CWG	CLC	Low Voltage Detect (LVD)	8-bit TMR with HLT	Windowed Watchdog Timer	CRC with Memory Scan	EUSART	I ² C/SPI	PPS	Peripheral Module Disable	Temperature Indicator	Debug(1)
PIC18F24Q10	16k	1024	256	25	4	2	24	1	1	2/2	1	0	1	3	Y	Y	1	1	Y	Y	Y	I
PIC18F25Q10	32k	2048	256	25	4	2	24	1	1	2/2	1	0	1	3	Y	Y	1	1	Y	Y	Y	I
PIC18F26Q10	64k	3615	1024	25	4	2	24	1	1	2/2	1	8	1	3	Y	Y	2	2	Y	Y	Y	I
PIC18F27Q10	128k	3615	1024	25	4	2	24	1	1	2/2	1	8	1	3	Y	Y	2	2	Y	Y	Y	I
PIC18F45Q10	32k	2048	256	36	4	2	35	1	1	2/2	1	8	1	3	Y	Y	2	2	Y	Y	Y	I
PIC18F46Q10	64k	3615	1024	36	4	2	35	1	1	2/2	1	8	1	3	Y	Y	2	2	Y	Y	Y	I
PIC18F47Q10	128k	3615	1024	36	4	2	35	1	1	2/2	1	8	1	3	Y	Y	2	2	Y	Y	Y	I

Note: Debugging Methods: (I) – Integrated on Chip.

Packages



Important: For other small form-factor package availability and marking information, visit <http://www.microchip.com/packaging> or contact your local Microchip sales office.

Packages	SPDIP (SP)	SOIC (SO)	SSOP (SS)	QFN (ML) (6x6x0.9)	VQFN (STX) (4x4x1)	TQFP (PT)	PDIP (P)	VQFN (NHX) (5x5x0.9)	QFN (ML) (8x8)
PIC18F24Q10	•	•	•	•	•				
PIC18F25Q10	•	•	•	•	•				
PIC18F26Q10	•	•	•	•	•				
PIC18F27Q10	•	•	•	•	•				
PIC18F45Q10						•	•	•	•
PIC18F46Q10						•	•	•	•
PIC18F47Q10						•	•	•	•



Important: Pin details are subject to change.

Pin Diagrams

Figure 1. 28-pin SPDIP, SSOP, SOIC

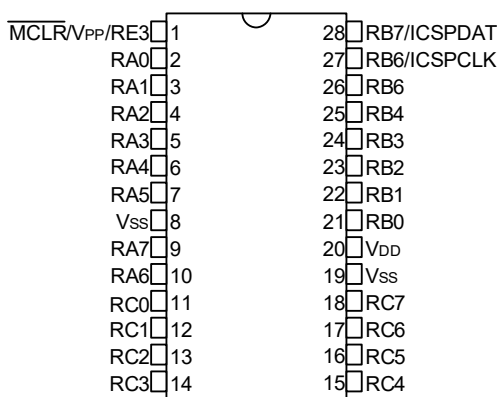

Rev. 00-000-028A
3/8/2017

Figure 2. 28-pin QFN, VQFN

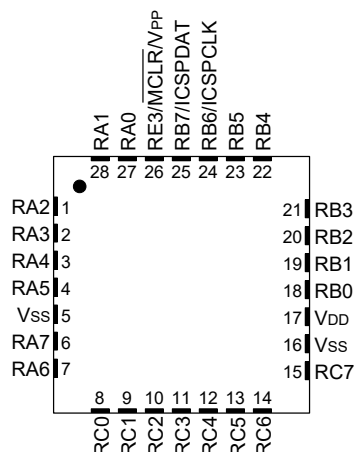

Rev. 00-000028B
6/23/2017

Note: It is recommended that the exposed bottom pad be connected to V_{SS} , however it must not be the only V_{SS} connection to the device.

Figure 3. 40-pin PDIP

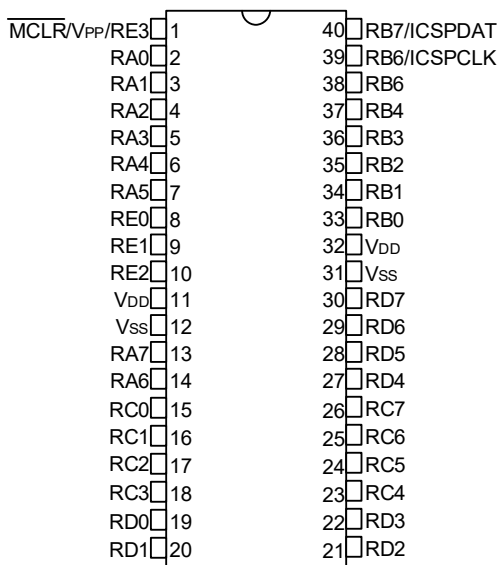

Rev. 00-000080A
3/6/2017

Figure 4. 40-pinVQFN

Rev. 00:000408
1/6/2017

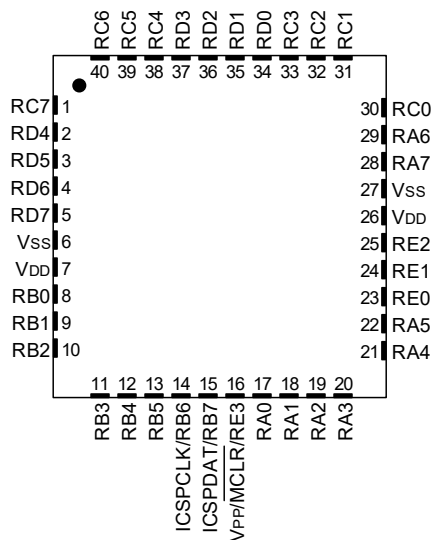

Note: It is recommended that the exposed bottom pad be connected to V_{SS} , however it must not be the only V_{SS} connection to the device.

Figure 5. 44-pin TQFP

Rev. 00:00044A
1/6/2017

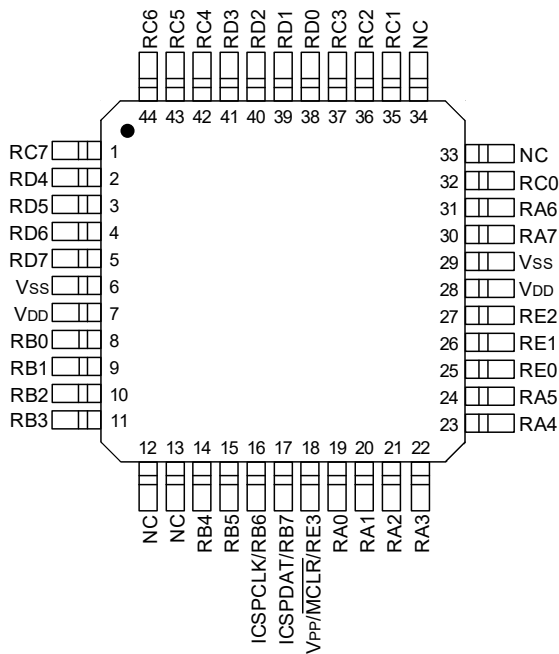
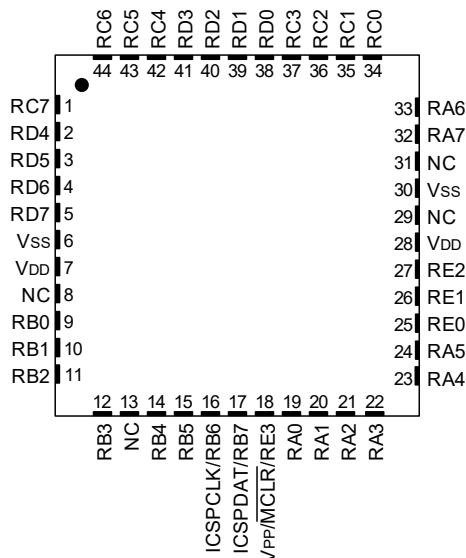

Figure 6. 44-pin QFN



Rev: 05-00044B
11/8/2017

Note: It is recommended that the exposed bottom pad be connected to V_{SS} , however it must not be the only V_{SS} connection to the device.

Pin Allocation Tables

Table 1. 28-Pin Allocation Table

I/O ⁽²⁾	28-Pin SPDIP, SOIC, SSOP	28-Pin (V)QFN	A/D	Reference	Comparator	Timers	CCP	CWG	ZCD	Interrupt	EUSART	DSM	MSSP	Pull- up	Basic
RA0	2	27	ANA0	—	C1IN0- C2IN0-	—	—	—	—	IOCA0	—	—	—	Y	—
RA1	3	28	ANA1	—	C1IN1- C2IN1-	—	—	—	—	IOCA1	—	—	—	Y	—
RA2	4	1	ANA2	DAC1OUT1 Vref- (DAC) Vref- (ADC)	C1IN0+ C2IN0+	—	—	—	—	IOCA2	—	—	—	Y	—
RA3	5	2	ANA3	Vref+ (DAC) Vref+ (ADC)	C1IN1+	—	—	—	—	IOCA3	—	MDCARL ⁽¹⁾	—	Y	—
RA4	6	3	ANA4	—	—	TOCKI ⁽¹⁾	—	—	—	IOCA4	—	MDCARH ⁽¹⁾	—	Y	—
RA5	7	4	ANA5	—	—	—	—	—	—	IOCA5	—	MDSRC ⁽¹⁾	SS1 ⁽¹⁾	Y	—
RA6	10	7	ANA6	—	—	—	—	—	—	IOCA6	—	—	—	Y	CLKOUT OSC2
RA7	9	6	ANA7	—	—	—	—	—	—	IOCA7	—	—	—	Y	OSC1 CLKIN
RB0	21	18	ANB0	—	C2IN1+	—	—	CWG1 ⁽¹⁾	ZCDIN	IOCB0 INT0 ⁽¹⁾	—	—	—	Y	—
RB1	22	19	ANB1	—	C1IN3- C2IN3-	—	—	—	—	IOCB1 INT1 ⁽¹⁾	—	—	—	Y	—
RB2	23	20	ANB2	—	—	—	—	—	—	IOCB2 INT2 ⁽¹⁾	—	—	—	Y	—

PIC18F2X/4XQ10

I/O ⁽²⁾	28-Pin SPDIP, SOIC, SSOP	28-Pin (V)QFN	A/D	Reference	Comparator	Timers	CCP	CWG	ZCD	Interrupt	EUSART	DSM	MSSP	Pull- up	Basic
RB3	24	21	ANB3	—	C1IN2- C2IN2-	—	—	—	—	IOCB3	—	—	—	Y	—
RB4	25	22	ANB4	—	—	T5G ⁽¹⁾	—	—	—	IOCB4	—	—	—	Y	—
RB5	26	23	ANB5	—	—	T1G ⁽¹⁾	—	—	—	IOCB5	—	—	—	Y	—
RB6	27	24	ANB6	—	—	—	—	—	—	IOCB6	—	—	—	Y	ICSPCLK
RB7	28	25	ANB7	DAC1OUT2	—	T6IN ⁽¹⁾	—	—	—	IOCB7	—	—	—	Y	ICSPDAT
RC0	11	8	ANC0	—	—	T1CKI ⁽¹⁾ T3CKI ⁽¹⁾ T3G ⁽¹⁾	—	—	—	IOCC0	—	—	—	Y	SOSCO
RC1	12	9	ANC1	—	—	—	CCP2 ⁽¹⁾	—	—	IOCC1	—	—	—	Y	SOSCIN SOSCI
RC2	13	10	ANC2	—	—	T5CKI ⁽¹⁾	CCP1 ⁽¹⁾	—	—	IOCC2	—	—	—	Y	—
RC3	14	11	ANC3	—	—	T2IN ⁽¹⁾	—	—	—	IOCC3	—	—	SCK1 ⁽¹⁾ SCL1 ^(3,4)	Y	—
RC4	15	12	ANC4	—	—	—	—	—	—	IOCC4	—	—	SDI1 ⁽¹⁾ SDA1 ^(3,4)	Y	—
RC5	16	13	ANC5	—	—	T4IN ⁽¹⁾	—	—	—	IOCC5	—	—	—	Y	—
RC6	17	14	ANC6	—	—	—	—	—	—	IOCC6	CK1 ^(1,3)	—	—	Y	—
RC7	18	15	ANC7	—	—	—	—	—	—	IOCC7	RX1/ DT1 ^(1,3)	—	—	Y	—
RE3	1	26	—	—	—	—	—	—	—	IOCE3	—	—	—	Y	Vpp/MCLR
VSS	19	16	—	—	—	—	—	—	—	—	—	—	—	—	VSS
VDD	20	17	—	—	—	—	—	—	—	—	—	—	—	—	VDD
VSS	8	5	—	—	—	—	—	—	—	—	—	—	—	—	VSS
OUT ⁽²⁾	—	—	ADGRDA ADGRDB	—	C1OUT C2OUT	TMR0	CCP1 CCP2 PWM3 PWM4	CWG1A CWG1B CWG1C CWG1D	—	—	TX1/ CK1 ⁽³⁾ DT1 ⁽³⁾	DSM	SDO1 SCK1	—	—

Note:

1. This is a PPS remappable input signal. The input function may be moved from the default location shown to one of several other PORTx pins. Refer to the peripheral input selection table for details on which port pins may be used for this signal.
2. All output signals shown in this row are PPS remappable. These signals may be mapped to output onto one of several PORTx pin options as described in the peripheral output selection table.
3. This is a bidirectional signal. For normal module operation, the firmware should map this signal to the same pin in both the PPS input and PPS output registers.
4. These pins are configured for I²C logic levels; The SCLx/SDAx signals may be assigned to any of these pins. PPS assignments to the other pins (e.g., RB1) will operate, but input logic levels will be standard TTL/ST as selected by the INLVL register, instead of the I²C specific or SMBus input buffer thresholds.

Table 2. 40/44-Pin Allocation Table

I/O ⁽²⁾	40- Pin PDIP	40- Pin VQFN	44- Pin QFN	44- Pin TQFP	A/D	Reference	Comparator	Timers	CCP	CWG	ZCD	Interrupt	EUSART	DSM	MSSP	Pull- up	Basic
RA0	2	17	19	19	ANA0	—	C1IN0- C2IN0-	—	—	—	—	IOCA0	—	—	—	Y	—
RA1	3	18	20	20	ANA1	—	C1IN1- C2IN1-	—	—	—	—	IOCA1	—	—	—	Y	—
RA2	4	19	21	21	ANA2	DAC1OUT1 Vref- (DAC5) Vref- (ADC)	C1IN0+ C2IN0+	—	—	—	—	IOCA2	—	—	—	Y	—
RA3	5	20	22	22	ANA3	Vref+ (DAC5)	C1IN1+	—	—	—	—	IOCA3	—	MDCARL ⁽¹⁾	—	Y	—

PIC18F2X/4XQ10

I/O ⁽²⁾	40-Pin PDIP	40-Pin VQFN	44-Pin QFN	44-Pin TQFP	A/D	Reference	Comparator	Timers	CCP	CWG	ZCD	Interrupt	EUSART	DSM	MSSP	Pull-up	Basic
						Vref+ (ADC)											
RA4	6	21	23	23	ANA4	—	—	T0CKI ⁽¹⁾	—	—	—	IOCA4	—	MDCARH ⁽¹⁾	—	Y	—
RA5	7	22	24	24	ANA5	—	—	—	—	—	—	IOCA5	—	MDSRC ⁽¹⁾	SS1 ⁽¹⁾	Y	—
RA6	14	29	33	31	ANA6	—	—	—	—	—	—	IOCA6	—	—	—	Y	CLKOUT OSC2
RA7	13	28	32	30	ANA7	—	—	—	—	—	—	IOCA7	—	—	—	Y	OSC1 CLKIN
RB0	33	8	9	8	ANB0	—	C2IN1+	—	—	CWG1 ⁽¹⁾	ZCDIN	IOCB0 INT0 ⁽¹⁾	—	—	SS2 ⁽¹⁾	Y	—
RB1	34	9	10	9	ANB1	—	C1IN3- C2IN3-	—	—	—	—	IOCB1 INT1 ⁽¹⁾	—	—	SCK2 ⁽¹⁾ SCL2 ^(3,4)	Y	—
RB2	35	10	11	10	ANB2	—	—	—	—	—	—	IOCB2 INT2 ⁽¹⁾	—	—	SDI2 ⁽¹⁾ SDA2 ^(3,4)	Y	—
RB3	36	11	12	11	ANB3	—	C1IN2- C2IN2-	—	—	—	—	IOCB3	—	—	—	Y	—
RB4	37	12	14	14	ANB4	—	—	T5G ⁽¹⁾	—	—	—	IOCB4	—	—	—	Y	—
RB5	38	13	15	15	ANB5	—	—	T1G ⁽¹⁾	—	—	—	IOCB5	—	—	—	Y	—
RB6	39	14	16	16	ANB6	—	—	—	—	—	—	IOCB6	CK2 ^(1,3)	—	—	Y	ICSPCLK
RB7	40	15	17	17	ANB7	DAC1OUT2	—	T6IN ⁽¹⁾	—	—	—	IOCB7	RX2/ DT2 ^(1,3)	—	—	Y	ICSPDAT
RC0	15	30	34	32	ANC0	—	—	T1CKI ⁽¹⁾ T3CKI ⁽¹⁾ T3G ⁽¹⁾	—	—	—	IOCC0	—	—	—	Y	SOSCO
RC1	16	31	35	35	ANC1	—	—	—	CCP2 ⁽¹⁾	—	—	IOCC1	—	—	—	Y	SOSCIN SOSCI
RC2	17	32	36	36	ANC2	—	—	T5CKI ⁽¹⁾	CCP1 ⁽¹⁾	—	—	IOCC2	—	—	—	Y	—
RC3	18	33	37	37	ANC3	—	—	T2IN ⁽¹⁾	—	—	—	IOCC3	—	—	SCK1 ⁽¹⁾ SCL1 ^(3,4)	Y	—
RC4	23	38	42	42	ANC4	—	—	—	—	—	—	IOCC4	—	—	SDI1 ⁽¹⁾ SDA1 ^(3,4)	—	—
RC5	24	39	43	43	ANC5	—	—	T4IN ⁽¹⁾	—	—	—	IOCC5	—	—	—	Y	—
RC6	25	40	44	44	ANC6	—	—	—	—	—	—	IOCC6	CK1 ^(1,3)	—	—	Y	—
RC7	26	1	1	1	ANC7	—	—	—	—	—	—	IOCC7	RX1/ DT1 ^(1,3)	—	—	Y	—
RD0	19	34	38	38	AND0	—	—	—	—	—	—	—	—	—	—	Y	—
RD1	20	35	39	39	AND1	—	—	—	—	—	—	—	—	—	—	Y	—
RD2	21	36	40	40	AND2	—	—	—	—	—	—	—	—	—	—	Y	—
RD3	22	37	41	41	AND3	—	—	—	—	—	—	—	—	—	—	Y	—
RD4	27	2	2	2	AND4	—	—	—	—	—	—	—	—	—	—	Y	—
RD5	28	3	3	3	AND5	—	—	—	—	—	—	—	—	—	—	Y	—
RD6	29	4	4	4	AND6	—	—	—	—	—	—	—	—	—	—	Y	—
RD7	30	5	5	5	AND7	—	—	—	—	—	—	—	—	—	—	Y	—
RE0	8	23	25	25	ANE0	—	—	—	—	—	—	—	—	—	—	Y	—
RE1	9	24	26	26	ANE1	—	—	—	—	—	—	—	—	—	—	Y	—

PIC18F2X/4XQ10

I/O ⁽²⁾	40-Pin PDIP	40-Pin VQFN	44-Pin QFN	44-Pin TQFP	A/D	Reference	Comparator	Timers	CCP	CWG	ZCD	Interrupt	EUSART	DSM	MSSP	Pull-up	Basic
RE2	10	25	27	27	ANE2	—	—	—	—	—	—	—	—	—	—	Y	—
RE3	1	16	18	18	—	—	—	—	—	—	—	IOCE3	—	—	—	Y	Vpp/ MCLR
VSS	12	6	6	6	—	—	—	—	—	—	—	—	—	—	—	—	VSS
VDD	11	7	7	7	—	—	—	—	—	—	—	—	—	—	—	—	VDD
VDD	32	26	28	28	—	—	—	—	—	—	—	—	—	—	—	—	VSS
VSS	31	27	30	29	—	—	—	—	—	—	—	—	—	—	—	—	VSS
OUT ⁽²⁾	—	—	—	—	ADGRDA ADGRDB	—	C1OUT C2OUT	TMR0	CCP1 CCP2 PWM3 PWM4	CWG1A CWG1B CWG1C CWG1D	—	—	TX1/ CK1 ⁽³⁾ DT1 ⁽³⁾ TX2/ CK2 ⁽³⁾ DT2 ⁽³⁾	DSM	SDO1 SCK1 SDO2 SCK2	—	—

Note:

1. This is a PPS remappable input signal. The input function may be moved from the default location shown to one of several other PORTx pins. Refer to the peripheral input selection table for details on which port pins may be used for this signal.
2. All output signals shown in this row are PPS remappable. These signals may be mapped to output onto one of several PORTx pin options as described in the peripheral output selection table.
3. This is a bidirectional signal. For normal module operation, the firmware should map this signal to the same pin in both the PPS input and PPS output registers.
4. These pins are configured for I²C logic levels; The SCLx/SDAx signals may be assigned to any of these pins. PPS assignments to the other pins (e.g., RB1) will operate, but input logic levels will be standard TTL/ST as selected by the INLVL register, instead of the I²C specific or SMBus input buffer thresholds.

The Microchip Web Site

Microchip provides online support via our web site at <http://www.microchip.com/>. This web site is used as a means to make files and information easily available to customers. Accessible by using your favorite Internet browser, the web site contains the following information:

- **Product Support** – Data sheets and errata, application notes and sample programs, design resources, user's guides and hardware support documents, latest software releases and archived software
- **General Technical Support** – Frequently Asked Questions (FAQ), technical support requests, online discussion groups, Microchip consultant program member listing
- **Business of Microchip** – Product selector and ordering guides, latest Microchip press releases, listing of seminars and events, listings of Microchip sales offices, distributors and factory representatives

Customer Change Notification Service

Microchip's customer notification service helps keep customers current on Microchip products. Subscribers will receive e-mail notification whenever there are changes, updates, revisions or errata related to a specified product family or development tool of interest.

To register, access the Microchip web site at <http://www.microchip.com/>. Under "Support", click on "Customer Change Notification" and follow the registration instructions.

Customer Support

Users of Microchip products can receive assistance through several channels:

- Distributor or Representative
- Local Sales Office
- Field Application Engineer (FAE)
- Technical Support

Customers should contact their distributor, representative or Field Application Engineer (FAE) for support. Local sales offices are also available to help customers. A listing of sales offices and locations is included in the back of this document.

Technical support is available through the web site at: <http://www.microchip.com/support>

Microchip Devices Code Protection Feature

Note the following details of the code protection feature on Microchip devices:

- Microchip products meet the specification contained in their particular Microchip Data Sheet.
- Microchip believes that its family of products is one of the most secure families of its kind on the market today, when used in the intended manner and under normal conditions.
- There are dishonest and possibly illegal methods used to breach the code protection feature. All of these methods, to our knowledge, require using the Microchip products in a manner outside the operating specifications contained in Microchip's Data Sheets. Most likely, the person doing so is engaged in theft of intellectual property.
- Microchip is willing to work with the customer who is concerned about the integrity of their code.

- Neither Microchip nor any other semiconductor manufacturer can guarantee the security of their code. Code protection does not mean that we are guaranteeing the product as “unbreakable.”

Code protection is constantly evolving. We at Microchip are committed to continuously improving the code protection features of our products. Attempts to break Microchip’s code protection feature may be a violation of the Digital Millennium Copyright Act. If such acts allow unauthorized access to your software or other copyrighted work, you may have a right to sue for relief under that Act.

Legal Notice

Information contained in this publication regarding device applications and the like is provided only for your convenience and may be superseded by updates. It is your responsibility to ensure that your application meets with your specifications. MICROCHIP MAKES NO REPRESENTATIONS OR WARRANTIES OF ANY KIND WHETHER EXPRESS OR IMPLIED, WRITTEN OR ORAL, STATUTORY OR OTHERWISE, RELATED TO THE INFORMATION, INCLUDING BUT NOT LIMITED TO ITS CONDITION, QUALITY, PERFORMANCE, MERCHANTABILITY OR FITNESS FOR PURPOSE. Microchip disclaims all liability arising from this information and its use. Use of Microchip devices in life support and/or safety applications is entirely at the buyer’s risk, and the buyer agrees to defend, indemnify and hold harmless Microchip from any and all damages, claims, suits, or expenses resulting from such use. No licenses are conveyed, implicitly or otherwise, under any Microchip intellectual property rights unless otherwise stated.

Trademarks

The Microchip name and logo, the Microchip logo, AnyRate, AVR, AVR logo, AVR Freaks, BeaconThings, BitCloud, CryptoMemory, CryptoRF, dsPIC, FlashFlex, flexPWR, Heldo, JukeBlox, KeeLoq, KeeLoq logo, Kleer, LANCheck, LINK MD, maXStylus, maXTouch, MediaLB, megaAVR, MOST, MOST logo, MPLAB, OptoLyzer, PIC, picoPower, PICSTART, PIC32 logo, Prochip Designer, QTouch, RightTouch, SAM-BA, SpyNIC, SST, SST Logo, SuperFlash, tinyAVR, UNI/O, and XMEGA are registered trademarks of Microchip Technology Incorporated in the U.S.A. and other countries.

ClockWorks, The Embedded Control Solutions Company, EtherSynch, Hyper Speed Control, HyperLight Load, IntelliMOS, mTouch, Precision Edge, and Quiet-Wire are registered trademarks of Microchip Technology Incorporated in the U.S.A.

Adjacent Key Suppression, AKS, Analog-for-the-Digital Age, Any Capacitor, AnyIn, AnyOut, BodyCom, chipKIT, chipKIT logo, CodeGuard, CryptoAuthentication, CryptoCompanion, CryptoController, dsPICDEM, dsPICDEM.net, Dynamic Average Matching, DAM, ECAN, EtherGREEN, In-Circuit Serial Programming, ICSP, Inter-Chip Connectivity, JitterBlocker, KleerNet, KleerNet logo, Mindi, MiWi, motorBench, MPASM, MPF, MPLAB Certified logo, MPLIB, MPLINK, MultiTRAK, NetDetach, Omniscient Code Generation, PICDEM, PICDEM.net, PICKit, PICtail, PureSilicon, QMatrix, RightTouch logo, REAL ICE, Ripple Blocker, SAM-ICE, Serial Quad I/O, SMART-I.S., SQI, SuperSwitcher, SuperSwitcher II, Total Endurance, TSHARC, USBCheck, VariSense, ViewSpan, WiperLock, Wireless DNA, and ZENA are trademarks of Microchip Technology Incorporated in the U.S.A. and other countries.

SQTP is a service mark of Microchip Technology Incorporated in the U.S.A.

Silicon Storage Technology is a registered trademark of Microchip Technology Inc. in other countries.

GestIC is a registered trademark of Microchip Technology Germany II GmbH & Co. KG, a subsidiary of Microchip Technology Inc., in other countries.

All other trademarks mentioned herein are property of their respective companies.

© 2018, Microchip Technology Incorporated, Printed in the U.S.A., All Rights Reserved.

ISBN: 978-1-5224-2949-4

Quality Management System Certified by DNV

ISO/TS 16949

Microchip received ISO/TS-16949:2009 certification for its worldwide headquarters, design and wafer fabrication facilities in Chandler and Tempe, Arizona; Gresham, Oregon and design centers in California and India. The Company's quality system processes and procedures are for its PIC[®] MCUs and dsPIC[®] DSCs, KEELOQ[®] code hopping devices, Serial EEPROMs, microperipherals, nonvolatile memory and analog products. In addition, Microchip's quality system for the design and manufacture of development systems is ISO 9001:2000 certified.

Worldwide Sales and Service

AMERICAS	ASIA/PACIFIC	ASIA/PACIFIC	EUROPE
<p>Corporate Office 2355 West Chandler Blvd. Chandler, AZ 85224-6199 Tel: 480-792-7200 Fax: 480-792-7277 Technical Support: http://www.microchip.com/support Web Address: www.microchip.com</p> <p>Atlanta Duluth, GA Tel: 678-957-9614 Fax: 678-957-1455</p> <p>Austin, TX Tel: 512-257-3370</p> <p>Boston Westborough, MA Tel: 774-760-0087 Fax: 774-760-0088</p> <p>Chicago Itasca, IL Tel: 630-285-0071 Fax: 630-285-0075</p> <p>Dallas Addison, TX Tel: 972-818-7423 Fax: 972-818-2924</p> <p>Detroit Novi, MI Tel: 248-848-4000</p> <p>Houston, TX Tel: 281-894-5983</p> <p>Indianapolis Noblesville, IN Tel: 317-773-8323 Fax: 317-773-5453 Tel: 317-536-2380</p> <p>Los Angeles Mission Viejo, CA Tel: 949-462-9523 Fax: 949-462-9608 Tel: 951-273-7800</p> <p>Raleigh, NC Tel: 919-844-7510</p> <p>New York, NY Tel: 631-435-6000</p> <p>San Jose, CA Tel: 408-735-9110 Tel: 408-436-4270</p> <p>Canada - Toronto Tel: 905-695-1980 Fax: 905-695-2078</p>	<p>Australia - Sydney Tel: 61-2-9868-6733</p> <p>China - Beijing Tel: 86-10-8569-7000</p> <p>China - Chengdu Tel: 86-28-8665-5511</p> <p>China - Chongqing Tel: 86-23-8980-9588</p> <p>China - Dongguan Tel: 86-769-8702-9880</p> <p>China - Guangzhou Tel: 86-20-8755-8029</p> <p>China - Hangzhou Tel: 86-571-8792-8115</p> <p>China - Hong Kong SAR Tel: 852-2943-5100</p> <p>China - Nanjing Tel: 86-25-8473-2460</p> <p>China - Qingdao Tel: 86-532-8502-7355</p> <p>China - Shanghai Tel: 86-21-3326-8000</p> <p>China - Shenyang Tel: 86-24-2334-2829</p> <p>China - Shenzhen Tel: 86-755-8864-2200</p> <p>China - Suzhou Tel: 86-186-6233-1526</p> <p>China - Wuhan Tel: 86-27-5980-5300</p> <p>China - Xian Tel: 86-29-8833-7252</p> <p>China - Xiamen Tel: 86-592-2388138</p> <p>China - Zhuhai Tel: 86-756-3210040</p>	<p>India - Bangalore Tel: 91-80-3090-4444</p> <p>India - New Delhi Tel: 91-11-4160-8631</p> <p>India - Pune Tel: 91-20-4121-0141</p> <p>Japan - Osaka Tel: 81-6-6152-7160</p> <p>Japan - Tokyo Tel: 81-3-6880-3770</p> <p>Korea - Daegu Tel: 82-53-744-4301</p> <p>Korea - Seoul Tel: 82-2-554-7200</p> <p>Malaysia - Kuala Lumpur Tel: 60-3-7651-7906</p> <p>Malaysia - Penang Tel: 60-4-227-8870</p> <p>Philippines - Manila Tel: 63-2-634-9065</p> <p>Singapore Tel: 65-6334-8870</p> <p>Taiwan - Hsin Chu Tel: 886-3-577-8366</p> <p>Taiwan - Kaohsiung Tel: 886-7-213-7830</p> <p>Taiwan - Taipei Tel: 886-2-2508-8600</p> <p>Thailand - Bangkok Tel: 66-2-694-1351</p> <p>Vietnam - Ho Chi Minh Tel: 84-28-5448-2100</p>	<p>Austria - Wels Tel: 43-7242-2244-39 Fax: 43-7242-2244-393</p> <p>Denmark - Copenhagen Tel: 45-4450-2828 Fax: 45-4485-2829</p> <p>Finland - Espoo Tel: 358-9-4520-820</p> <p>France - Paris Tel: 33-1-69-53-63-20 Fax: 33-1-69-30-90-79</p> <p>Germany - Garching Tel: 49-8931-9700</p> <p>Germany - Haan Tel: 49-2129-3766400</p> <p>Germany - Heilbronn Tel: 49-7131-67-3636</p> <p>Germany - Karlsruhe Tel: 49-721-625370</p> <p>Germany - Munich Tel: 49-89-627-144-0 Fax: 49-89-627-144-44</p> <p>Germany - Rosenheim Tel: 49-8031-354-560</p> <p>Israel - Ra'anana Tel: 972-9-744-7705</p> <p>Italy - Milan Tel: 39-0331-742611 Fax: 39-0331-466781</p> <p>Italy - Padova Tel: 39-049-7625286</p> <p>Netherlands - Drunen Tel: 31-416-690399 Fax: 31-416-690340</p> <p>Norway - Trondheim Tel: 47-7289-7561</p> <p>Poland - Warsaw Tel: 48-22-3325737</p> <p>Romania - Bucharest Tel: 40-21-407-87-50</p> <p>Spain - Madrid Tel: 34-91-708-08-90 Fax: 34-91-708-08-91</p> <p>Sweden - Gothenberg Tel: 46-31-704-60-40</p> <p>Sweden - Stockholm Tel: 46-8-5090-4654</p> <p>UK - Wokingham Tel: 44-118-921-5800 Fax: 44-118-921-5820</p>

Mouser Electronics

Authorized Distributor

Click to View Pricing, Inventory, Delivery & Lifecycle Information:

Microchip:

[PIC18F47Q10T-I/PT](#) [PIC18F47Q10-I/P](#) [PIC18F27Q10-E/SO](#) [PIC18F27Q10-I/SO](#) [PIC18F27Q10T-I/SS](#)
[PIC18F27Q10-E/ML](#) [PIC18F47Q10T-I/ML](#) [PIC18F47Q10-I/ML](#) [PIC18F27Q10-I/ML](#) [PIC18F47Q10-E/PT](#)
[PIC18F47Q10-E/ML](#) [PIC18F27Q10-E/SP](#) [PIC18F47Q10-I/PT](#) [PIC18F27Q10-I/SP](#) [PIC18F27Q10T-I/SO](#)
[PIC18F27Q10-I/SS](#) [PIC18F27Q10T-I/ML](#) [PIC18F47Q10-E/P](#) [PIC18F27Q10-E/SS](#) [PIC18F27Q10-I/STX](#)
[PIC18F27Q10-E/STX](#) [PIC18F47Q10-E/MP](#) [PIC18F47Q10T-I/MP](#) [PIC18F47Q10-I/MP](#) [PIC18F27Q10T-I/STX](#)



Компания «ЭлектроПласт» предлагает заключение долгосрочных отношений при поставках импортных электронных компонентов на взаимовыгодных условиях!

Наши преимущества:

- Оперативные поставки широкого спектра электронных компонентов отечественного и импортного производства напрямую от производителей и с крупнейших мировых складов;
- Поставка более 17-ти миллионов наименований электронных компонентов;
- Поставка сложных, дефицитных, либо снятых с производства позиций;
- Оперативные сроки поставки под заказ (от 5 рабочих дней);
- Экспресс доставка в любую точку России;
- Техническая поддержка проекта, помощь в подборе аналогов, поставка прототипов;
- Система менеджмента качества сертифицирована по Международному стандарту ISO 9001;
- Лицензия ФСБ на осуществление работ с использованием сведений, составляющих государственную тайну;
- Поставка специализированных компонентов (Xilinx, Altera, Analog Devices, Intersil, Interpoint, Microsemi, Aeroflex, Peregrine, Syfer, Eurofarad, Texas Instrument, Miteq, Cobham, E2V, MA-COM, Hittite, Mini-Circuits, General Dynamics и др.);

Помимо этого, одним из направлений компании «ЭлектроПласт» является направление «Источники питания». Мы предлагаем Вам помощь Конструкторского отдела:

- Подбор оптимального решения, техническое обоснование при выборе компонента;
- Подбор аналогов;
- Консультации по применению компонента;
- Поставка образцов и прототипов;
- Техническая поддержка проекта;
- Защита от снятия компонента с производства.



Как с нами связаться

Телефон: 8 (812) 309 58 32 (многоканальный)

Факс: 8 (812) 320-02-42

Электронная почта: org@eplast1.ru

Адрес: 198099, г. Санкт-Петербург, ул. Калинина, дом 2, корпус 4, литера А.